

Contents

Contents i

3800HGV-B Overview	1
Installation Requirements	4
Connect the Computer to the Gateway	5
Choose a Computer and Connection Type	5
Ethernet Connection	6
Wireless Connection	7
Non-2Wire Wireless Adapter Configuration	8
Locating the Serial Number and Wireless Encryption Key	8
Configuring the Adapter	8
USB to PC Connection	9
Install the 2Wire Gateway USB Driver - Windows	9
Install the 2Wire Gateway USB Driver - Macintosh	10
Connect the Broadband Interface	11
Connecting to VDSL via CoAX	11
Connect to IPTV	12
Setting Up IPTV	12
Gateway User Interface	13
Gateway (System) Pages	13
Viewing Your System Summary	13
Setting a System Password	14
Changing Your Time Zone Settings	14
Viewing System Details	15
Broadband Link Pages	15
Viewing Your Broadband Link Summary	15
Viewing Broadband Link Details	16
Using Broadband Diagnostics	17
Viewing Statistics	18
Using Broadband Link Advanced Settings	19
Home Network Pages	20
Viewing Your Home Network Summary	20
Local Devices	20
Status at a Glance Panel	21
Monitoring Your Wireless Settings	21
Customizing Security Settings	23
Configuring Additional Settings	23
Configuring Advanced Settings	24
Editing Address Allocation Settings	25
Firewall Pages	26
Viewing Your Firewall Summary	26
Configuring Firewall Settings	28
Configuring Advanced Firewall Settings	29
Enabling Advanced Security	29
Allowing Inbound and Outbound Traffic	30
Disabling Attack Detection	30
Access the Management and Diagnostic Console	32

Accessing the Management and Diagnostic Console 32

 System Summary Page 32

 Broadband Link - Summary Page 34

 Broadband Link - Statistics Page 35

 Broadband Link - Configuration Page 37

 Local Network - Status Page 38

 Local Network - Statistics Page 40

 Local Network - Device List Page 41

 Local Network - Wireless Settings Page 42

 Local Network - Configuration Page 43

 Enabling Router Behind Router Alert 43

 Local Network - Address Allocation Page 44

 Local Network - Configure the MoCA Network Page 45

 Local Network - MoCA Statistics Page 46

 Firewall - Settings Page 47

 Firewall - Detailed Information Page 48

 Firewall - Advanced Settings Page 49

 Troubleshooting - DSL Diagnostics Page 50

 Analyzing General Information 50

 Reviewing Training History 51

 Reviewing Bitloading 52

 Troubleshooting - Event Log Page 53

 Troubleshooting - Network Tests Page 55

 Troubleshooting - Upgrade History Page 56

 Troubleshooting Resets Page 57

 Advanced - Syslog Settings Page 58

 Advanced - Provisioning Info Page 59

 Advanced - Configure Time Services Page 60

 Advanced - Configure Services Page 61

 Advanced - DNS Resolve Page 62

 Advanced - Link Manager States Page 63

 Advanced - Detailed Log Page 64

Upgrade the Software 65

Configuring Multiple Static IP Addresses 67

 Step 1: Enable Public Network Mode 68

 Step 2: Allocate Public IP Addresses to the LAN Clients 69

 Step 3: Configure Firewall Rules 70

 Sample Configuration 71

LEDs 76

 LED overview 76

Glossary 78

Regulatory Information 79



3800HGV-B Overview

The **3800HGV-B** is a residential gateway used to connect to the Lightspeed network. It has many of the features of an advanced broadband router as well as some additional features. Following are some of the major features of the 2Wire gateway.

Advanced modem technology. 2Wire's modem technology features enhanced bridge tap, long loop, and disturber performance.

Super-fast router. The 2Wire gateway's router provides the fastest data transfer speeds available between the network and the Internet. The high-performance router distributes data seamlessly to all of the computers on the network, without a dramatic loss of performance or speed.

Professional-grade firewall. The 2Wire gateway firewall includes both standard NAT/PAT security and Stateful Packet Inspection to defend against Denial of Service Internet attacks.

Flexible networking. The 2Wire gateway includes a variety of home networking technologies in one box: Ethernet, direct USB, HyperG wireless,¹ and MoCA.

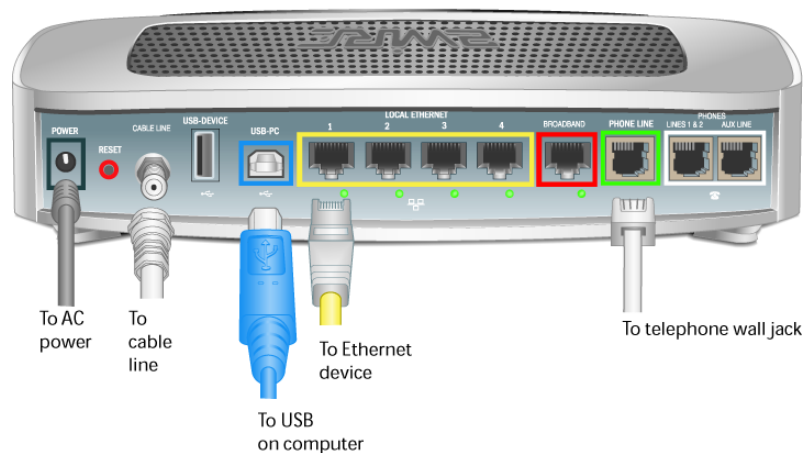

Figure 1. 3800HGV-B, Rear View



Note: The **Phones Lines 1&2/Aux Line** ports are reserved for connecting to VoIP service, and are not currently active.

Ethernet. Ethernet is a local area network (LAN) technology that transmits information between computers at speeds of 10 or 100 Mbps. The 3700HGV-B has 4 Ethernet ports for directly connecting computers or devices. If the home or office is wired for Ethernet, use the Ethernet interface(s) on the gateway to create a broadband network.

USB. The 2Wire gateway's USB 1.1 port allows users to directly connect a computer or other network-ready device.

1. Some interfaces are not available on specific models.

Wireless. The 2Wire gateway includes an integrated wireless access point, which allows users to roam wirelessly throughout the home or office. 2Wire's high-powered wireless technology virtually eliminates wireless "coldspots" in the home. The 2Wire gateway's high power 400mW transmitter ensures that users benefit from increased wireless bandwidth throughout the coverage area. In addition, the 2Wire gateway employs a special triple antenna design. The third antenna is used only for transmitting packets, thus mitigating the power loss associated with switching the antenna use back and forth between transmit and receive. This results in greater access point sensitivity, as antenna placement can be better optimized with a dedicated set of receive-only antennas.

MoCA. MoCA technology allows users to easily share digital entertainment throughout the home using the existing coax cable infrastructure to distribute content such as video (SDTV and HDTV), music, games, and images. MoCA provides the following benefits:

- Multi-room HDTV DVR. Allows users to record and share digital videos simultaneously in every room.
- Multi-room gaming. Allows users to access games from various locations in the home and play simultaneously.
- PC to TV. Allows users to merge data and video-centric networks throughout the home.

802.1X Authentication. 802.1X Authentication provides port-based authentication using certificates. These certificates reside in the RADIUS authentication server and the 3700HGV-B gateway, and are signed by a Certificate Authority (CA). When the RADIUS server and the gateway successfully exchange certificates, access to the network is allowed.

Prior to authentication, only limited security traffic (Layer 1 and Layer 2) is allowed on ports. After authentication, ports open up for all other traffic (such as DHCP, IP, or Layer 3 and above).

The VDSL DSLAM is the authenticator between the 3700HGV-B and the RADIUS server. The RADIUS server provides authentication and authorization for the 3700HGV-B, and decides if the VDSLAM will open the port for upper layer traffic. The 3700HGV-B and RADIUS server will exchange certificates to provide mutual authentication. They will ensure that the certificate was issued from a trusted CA and that the certificates are valid, and other related information.

If the VDSL DSLAM port is not configured for 802.1X, the 3700HGV-B attempts to authenticate 3 times. If it cannot authenticate, it bypasses 802.1X authentication. This does not mean that the 3700HGV-B will be allowed on the network, just that it does not attempt the authentication again until power cycled or the network requests it.

802.1x Setup

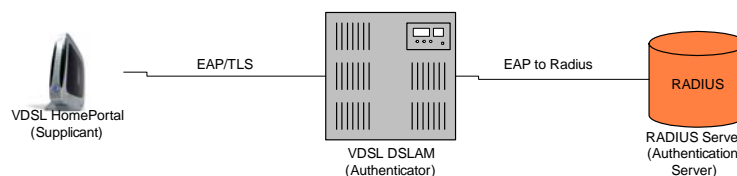

VDSL. VDSL (very high bit-rate DSL) operates over the copper wires in a phone line in a manner similar to ADSL, but at much faster speeds. VDSL can achieve speeds as high as 52 Mbps downstream and 16 Mbps upstream, as opposed to ADSL (up to 8 Mbps downstream and 800 Kbps upstream).

Installation Requirements

Before you begin installation, review the **3800HGV-B** package contents and ensure that you have available the items shown in Figure 2¹.

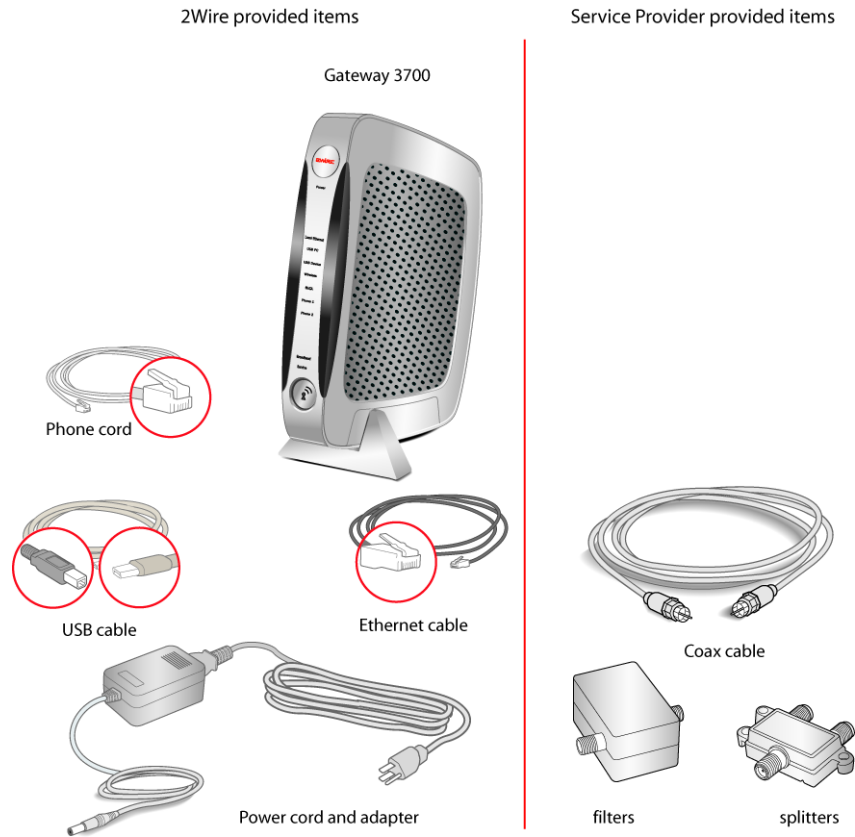

Figure 2. 2Wire and Service Provider Installation Components



Note: Vertical orientation is the preferred method for mounting the 3700HGV-B gateway. Please use the mounting stand included with the 3700HGV-B gateway.

1. Additional components may be provided by your service provider.

Connect the Computer to the Gateway



Note: Any equipment or devices that must be installed at the NID are outside the scope of this document.

Choose a Computer and Connection Type

If the customer has ordered IPTV and High Speed Internet, the preferred location for installing the 3700HGV-B is by the first video set top box. In this case, the first PC may or may not be located in the same room. If the customer ordered High Speed Internet access only, then the 3700HGV-B should be installed near the first PC. Computers can be connected to the 3700HGV-B via Ethernet, wireless, USB, or MoCA.

The first computer you connect to the network is used to configure the 3700HGV-B for proper operation. If the customer has *not* ordered High Speed Internet, then the technician must use their assigned laptop to configure the 3700HGV-B.

Choose one of the following methods to connect the first computer to the 3700HGV-B. Save and close all open programs before you begin connecting the 3700HGV-B.

Connection Type	Page
Ethernet	page 6
Wireless	page 7
USB	page 9

Ethernet Connection

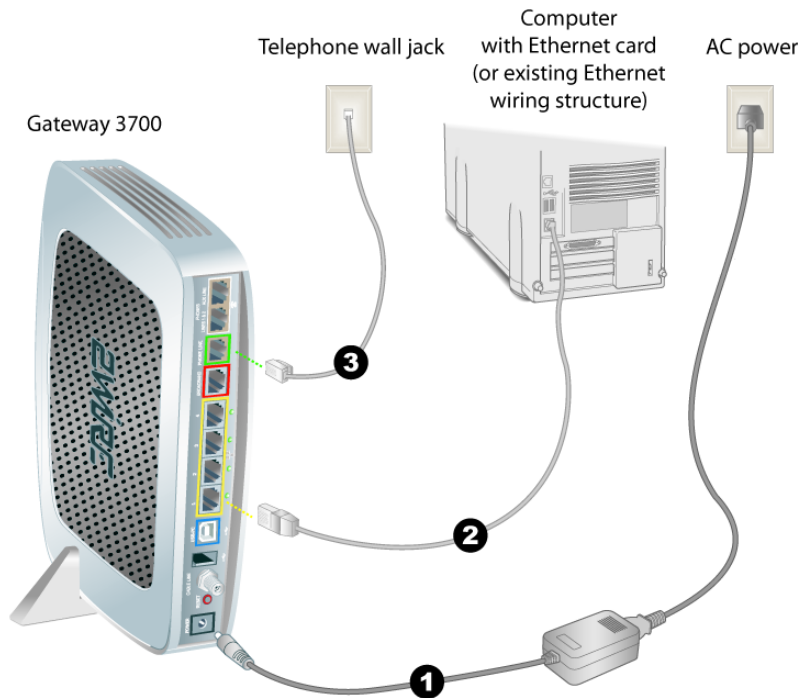

1. Connect the provided power adapter from the 3700HGV-B's **POWER** port to an electrical outlet. After the 3700HGV-B has completed its start up process, the **POWER** light on the front of the 3700HGV-B should be green.
2. Connect the yellow Ethernet cable provided with the 3700HGV-B from any available **ETHERNET** port on the 3700HGV-B to the computer's Ethernet port.
3. *If the VDSL signal is carried over the phone line, connect the provided gray phone cable from the gateway's **PHONE LINE** port to telephone wall jack. If the VDSL signal is carried over coax, refer to page 11.*

Wireless Connection

Requires wireless-enabled notebook or a computer with an 802.11b/g wireless network adapter installed. Wireless adapters can be purchased from the service provider.

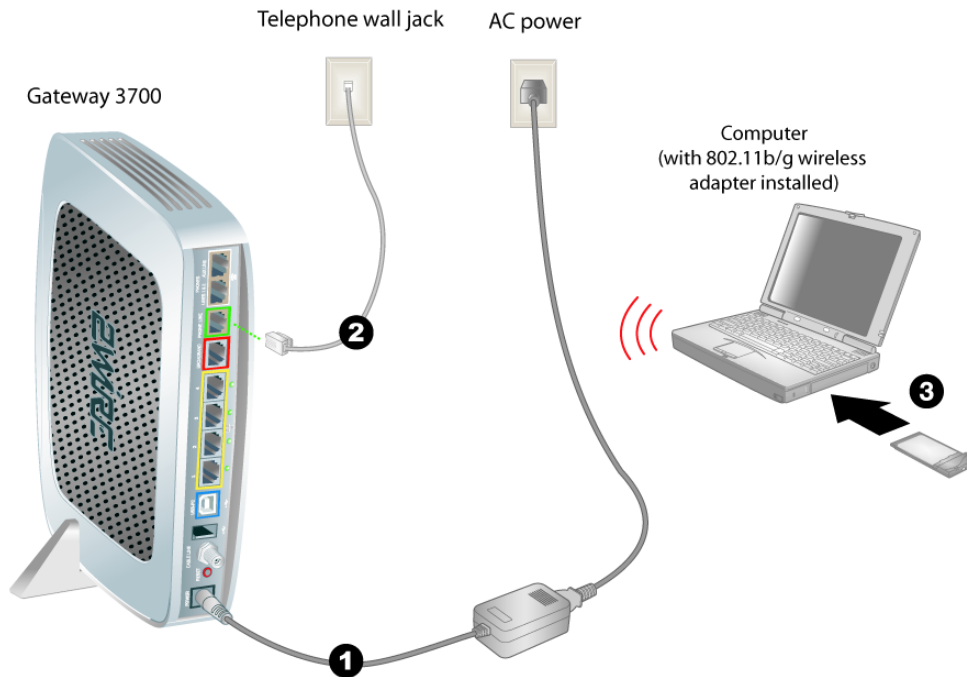

1. Connect the provided AC power adapter from the 3700HGV-B's **POWER** port to an electrical outlet. After the 3700HGV-B has completed its start up process, the **POWER** light on the front of the 3700HGV-B should be green.
2. If the VDSL signal is carried over the phone line, connect the provided gray phone cable from the 3700HGV-B's **PHONE LINE** port to telephone wall jack. If the VDSL signal is carried over coax, refer to page 11.
3. Install the wireless adapter according to the manufacturer's instructions (see note below).



Note: If you use a 2Wire wireless adapter (PCI, PC card, or USB adapter) for wireless networking, the 2Wire gateway Setup Wizard CD automatically configures it to communicate with the gateway during setup. If you are *NOT* using a 2Wire wireless adapter, you must manually configure your adapter to communicate with the gateway using the information on page 8.

Non-2Wire Wireless Adapter Configuration

Locating the Serial Number and Wireless Encryption Key

A portion of the serial number of your 3700HGV-B is used as the network name (SSID). Beneath the serial number is a ten-digit number which is used as the encryption key. These are located on the bottom of your 3700HGV-B (shown in vertical orientation). You will need this information to configure your wireless adapter.

Configuring the Adapter

1. Install and configure your wireless adapter according to the manufacturer's instructions.
2. Use the network adapter configuration software or Windows network connection wizard to set the network name (SSID) and encryption key (WPA).
 - a. The network name is the word "2WIRE" (in all capital letters), followed by the last three digits of the gateway serial number (for example, 2WIRE110).
 - b. The encryption key is a 64-bit hex value, located beneath the bar code on the bottom of the 2Wire gateway. In the example, it is 4119627022.
 - c. For Mac OS X users, you may need to enter the "\$" character at the beginning of the encryption key (for example, \$4119627022).

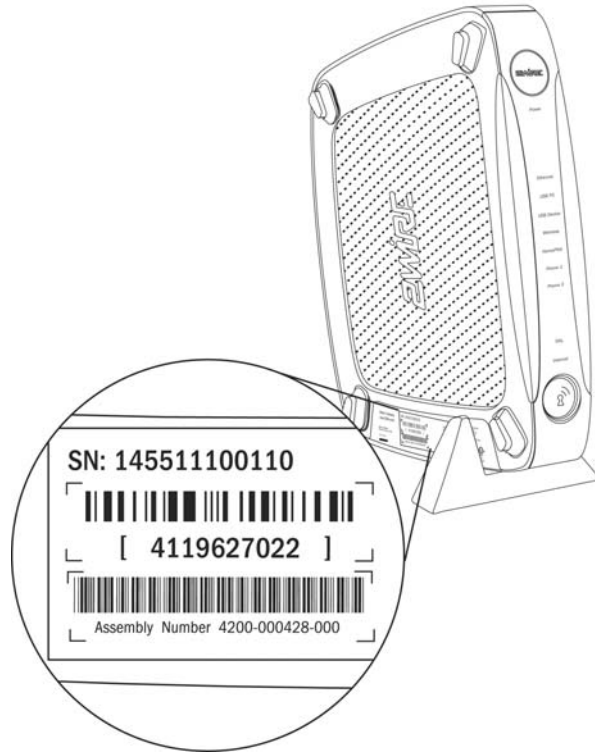

Note: The above instructions are for users configuring their adapter with WPA. If the user's wireless adapter doesn't support WPA they should use WEP; however, this decreases the level of security provided for wireless traffic.

USB to PC Connection

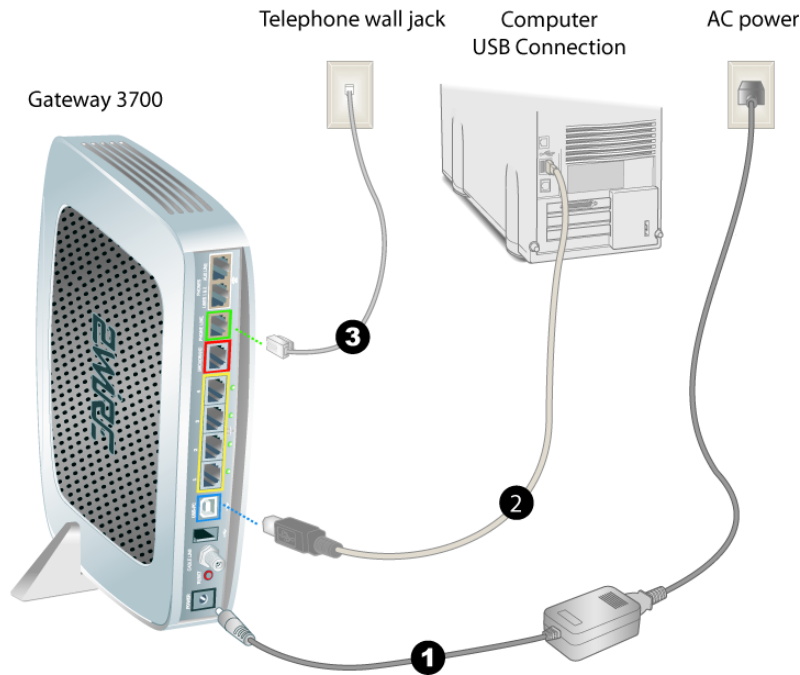

1. Connect the provided AC power adapter from the 3700HGV-B's **POWER** port to an electrical outlet. After the 3700HGV-B has completed its start up process, the **POWER** light on the front of the 3700HGV-B should be green.
2. Connect the provided blue USB cable from the 3700HGV-B's **USB-PC** port to the USB port on the computer.
3. *If the VDSL signal is carried over the phone line, connect the provided gray phone cable from the 3700HGV-B's **PHONE LINE** port to telephone wall jack. If the VDSL signal is carried over coax, refer to page 11.*

Install the 2Wire Gateway USB Driver - Windows

1. Insert the 2Wire setup CD in your computer's CD-ROM drive.
2. Power on the computer. If the Add Hardware Wizard displays, follow the on-screen instructions. If prompted to identify where to search for drivers, deselect **Floppy Disk drive** and check **CD-ROM drive**.
3. After the driver installs click **Finish** to complete the driver installation. The Setup Wizard will resume when the PC has rebooted.



Note: Microsoft Windows 98 users may be prompted to insert the Windows 98 installation CD-ROM after installing the 2Wire gateway USB drivers. After the Windows 98 updates are complete, remove the Windows 98 CD and reinsert the Setup Wizard CD into the CD-ROM prior to rebooting the PC.

Install the 2Wire Gateway USB Driver - Macintosh



Note: The 2Wire gateway supports USB for Macintosh OS 8.6, 9.2, 10.1.4, 10.1.5, 10.2.0, 10.2.1 to 10.2.6, 10.3.3 to 10.3.9, 10.4.0, and 10.4.1.

Before making the USB connection to the gateway, you must install the 2Wire gateway USB driver on the computer. The following instructions are for USB installation on Macintosh computers running OS 10.2.

1. With the computer powered on and the 2Wire Setup Wizard CD in the CD-ROM drive, double-click the 2Wire CD icon on the desktop.
2. Double-click 2Wire USB to begin the driver installation.
3. If the user has set up an administrator name and password, the Authenticate screen opens. Enter the administrator name and password and click **OK**.
4. Follow the on-screen instructions. When the driver installation is complete, you will be prompted to restart the computer.
5. After the computer restarts, connect the provided blue USB cable from the **USB-PC** port on the 2Wire gateway to the computer's **USB** port.

Connect the Broadband Interface

Now that you have completed the Power and LAN connections, it is time to connect to the broadband interface. There are two connection methods available:

- VDSL over RJ-11
- VDSL over Coax

If the 3700HGV-B is receiving the VDSL signal via RJ-11, that step was completed in the previous chapter. If the 3700HGV-B is receiving the VDSL signal via CoAX, refer to the following section.

Connecting to VDSL via CoAX

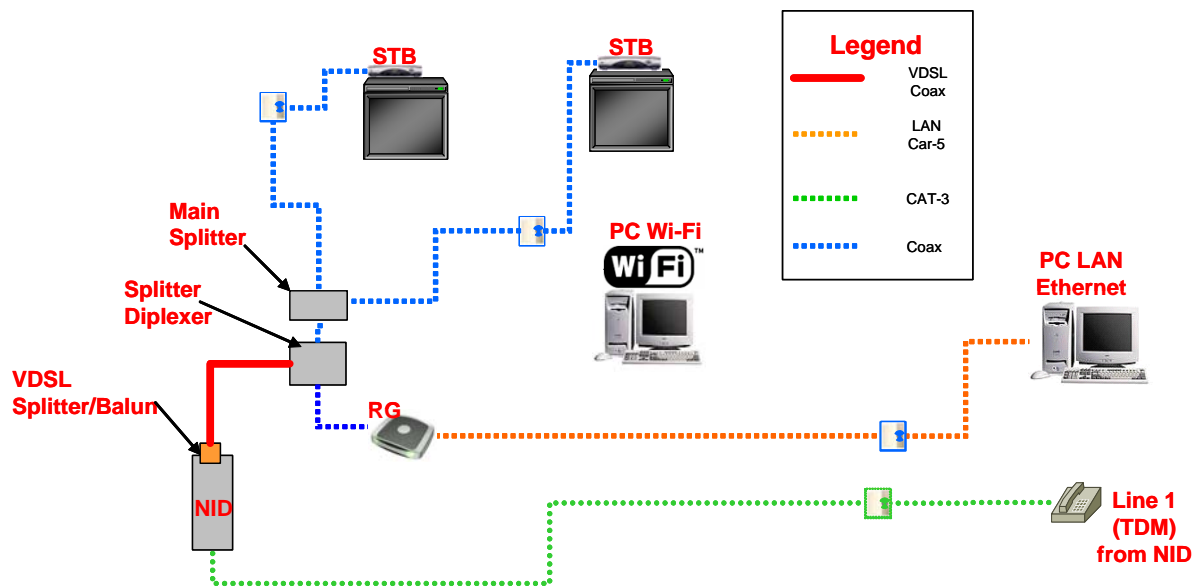
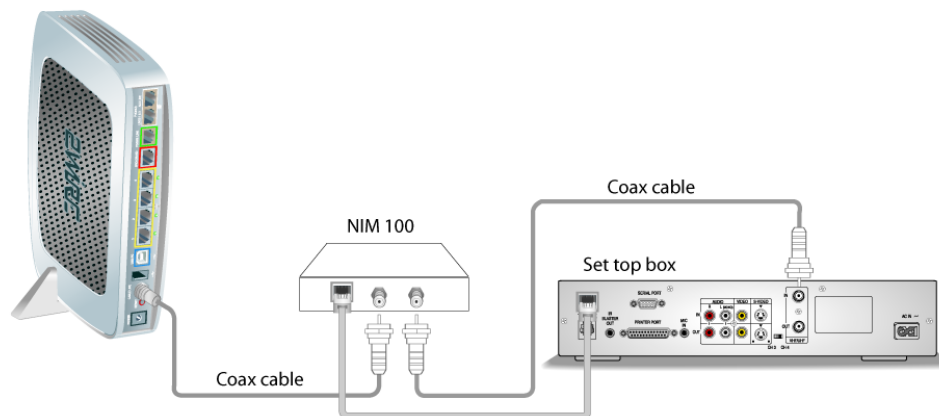

Figure 3. Inside Wiring Diagram

Connect to IPTV

Setting Up IPTV

While the 3700HGV-B supports MoCA directly connected to it, it will not be used by SBC during the Controlled Launch. Instead MoCA or HomePNA will be terminated on an Ethernet over CoAX bridge (for example, a Scientific Atlanta device or a Motorola NIM 100), which connects to an Ethernet port on the 3700HGV-B.



Note: The NIM100 is independently powered, and should be installed close to a power outlet. Refer to the manufacturer's instructions that came with the NIM100.

1. Connect a coaxial cable from the gateway's **CABLE LINE** port to the NIM100's **CABLE IN** port.
2. Connect an Ethernet cable from the NIM100's **Ethernet** port to the Ethernet port on the set top box.

Gateway User Interface

This chapter describes the 2Wire gateway user interface.



Note: 2Wire recommends that you use Internet Explorer 5.5 (or higher) or Netscape 6 (or higher).

Gateway (System) Pages

Viewing Your System Summary

The System Summary page provides general information and links to the gateway's most commonly used features.

The screenshot displays the 2Wire gateway user interface. At the top left is the 2Wire logo. Below it are navigation tabs: Summary (selected), System Password, Date and Time Settings, and Details. On the right, there are icons for System, Broadband Link, Home Network, and Firewall. A navigation bar at the top right contains HOME and Site Map links. The main content area is titled "Network at a Glance" and contains three sections: "3700HGV-B Gateway" (Software: 4.23.17, Password: Not Set), "Broadband Link" (No Physical Link Signal, Connection Speed: -- kbps), and "Home Network" (Computers: bart, RMARVIN). To the right of the Network at a Glance panel is a "Firewall" section showing "Firewall Active" and a link to "View firewall summary".

The Network at a Glance panel provides a summary of the System, Broadband Link, and Home Network states of your gateway.

- The System area of the Network at a Glance panel displays your 2Wire gateway model name, the version of gateway software that you are using, and the status of your gateway password. *If a password has been set, you must enter it before you can access 3700HGV-B configuration pages.*
- The Broadband Link area of the Network at a Glance panel displays the overall status of your gateway's physical and Internet-level connectivity.
- The Home Network area of the Network at a Glance panel displays your system's **LOCAL NETWORK** light status and a list of the devices currently connected to your local network.

Setting a System Password

Setting a system password protects your gateway settings from being modified or changed by someone who has not been given permission to do so. After setting a system password, you will be required to enter it whenever you attempt to access a gateway configuration page — for example, if you try to change the gateway's broadband connection settings or upgrade the gateway software. If a password has not been set, a reminder notice is displayed when you attempt to access pages where settings can be changed.

2WIRE System Broadband Link Home Network Firewall

Summary **System Password** Date and Time Settings Details HOME Site Map

Edit System Password

Settings

Password Protection
 Enable Check ENABLE to require a password to modify settings.

If Password Protection Is Enabled...

Enter New Password:

Confirm New Password:

When you choose to password protect the system settings, you should also set up a password hint. This hint can be a word, phrase, or question that will help you remember your password if you forget it.

Your password should be something unique that others cannot easily guess. Likewise, your hint should be something simple that reminds you what your password is without making it obvious to others.

Enter Your Hint:

Current Settings

 **No Password Set**
 The system password allows you to control who can change settings on the system.

Changing Your Time Zone Settings

The 2Wire gateway sets the time automatically using time servers on the Internet. It retrieves date/time information in Greenwich Mean Time (GMT). You can set or change the Time Zone settings in the Edit Date and Time Settings page.

2WIRE System Broadband Link Home Network Firewall

Summary System Password **Date and Time Settings** Details HOME Site Map

Edit Date and Time Settings

Settings

Current Date and Time
 Retrieving date and time settings from the Internet...

Select Your Time Zone
 The date and time are automatically set using time servers on the Internet. The local time is set correctly when you select your time zone. Select the time zone below and click SAVE.

Viewing System Details

The System Details page provides information about your gateway, any enhanced services you may have, and provides a link that you can use to restart your system.

Z-WIRE System Broadband Link Home Network Firewall

Summary System Password Date and Time Settings **Details** HOME Site Map

View System Details

Details

	Model:	3700HGV-B Gateway	Restart the system
	Serial Number:	315114005324	
	Hardware Version:	2700-000499-001	
	Software Version:	4.23.17	
	Key Code:	52HP-2374-2262-22AT-B2KR	

Broadband Link Pages

Viewing Your Broadband Link Summary

The Broadband Link Summary page provides general information about the current status of your broadband link connection and your system configuration.

Z-WIRE System Broadband Link Home Network Firewall

Summary Details **Diagnostics** Statistics Advanced Settings HOME Site Map

View Broadband Link Summary

Connection

	No Physical Link Signal		View connection details
	• DSL Link:	Not connected	
	• Internet:	Not connected	
	Connection Speed:		
	• Incoming:	0 kbps	
	• Outgoing:	0 kbps	
	Connection Information:		
	• Internet Address:		
	• Hardware Address:	00:12:88:dd:ca:d8	
	• Key Code:	52HP-2374-2262-22AT-B2KR	

The Connection panel shows information about your gateway's connection to your broadband service. The elements displayed will vary, depending on your gateway model and the type of broadband service you have.

- **Connection Status.** There are two ways you can check the current status of your gateway's broadband connection: you can use the BROADBAND LINK indicator light on the front of your gateway, or, if your computer is connected to the network, you can view the user interface. Connection Speed
- **Connection Speed** shows the incoming and outgoing data rates of your DSL connection, measured in kilobits per second (Kbps). Incoming is the speed of data flowing from the Internet to your network; Outgoing is the speed of data flowing from your network to the Internet.
- **Connection Information.** Connection Information shows the following basic system configuration information:
 - **Internet Address.** The broadband IP address assigned by your service provider to your gateway so that it can communicate on the service provider's network. This address is assigned to you by your broadband Service Provider for all communication on the broadband network.
 - **Hardware Address.** (Also known as the MAC address or physical address). When your gateway is connected to the broadband network, an association is made between its unique hardware address and its Internet address before it can communicate to the broadband network.
 - **Key Code.** The activation code that tells your gateway how to connect to your service provider. The key code is used during the installation process to customize the settings for your broadband provider.

Viewing Broadband Link Details

The Broadband Link Details page displays technical information about your broadband connection. Technical support representatives use this information to help troubleshoot problems with your broadband connection.

The screenshot shows the Z-Wire Gateway User Interface. At the top, there is a navigation bar with icons for System, Broadband Link, Home Network, and Firewall. Below this are tabs for Summary, Details (selected), Diagnostics, Statistics, and Advanced Settings. The main content area is titled "View Broadband Link Details" and contains a "Details" window with the following information:

DSL Connection Details	
DSL Line (Wire Pair):	Searching for DSL signal
Protocol:	--
Downstream Rate:	--
Upstream Rate:	--
Channel:	(none)
Current Noise Margin:	--
Current Attenuation:	--
Current Output Power:	--
DSLAM Vendor Information:	Country: [--] Vendor: [--] Specific: [--]

Internet Connection Details	
Connection Type:	Direct IP (DHCP or Static)
Internet Address:	--
Subnet Mask:	--
Default Gateway:	--
Primary Domain Name Server:	--
Secondary Domain Name Server:	--
Domain:	--
Maximum Transmission Unit (MTU):	--
Gateway Ping:	--
DNS Communication:	--
Configuration Server Post:	--

From Jeff M.:

Need to show Ethernet broadband example page.

The information displayed depends on the type of broadband service you have and your gateway model.

Using Broadband Diagnostics

Diagnostics displays an itemized list of your broadband connection's current status. Technical support representatives use this information to help troubleshoot problems with your broadband connection.

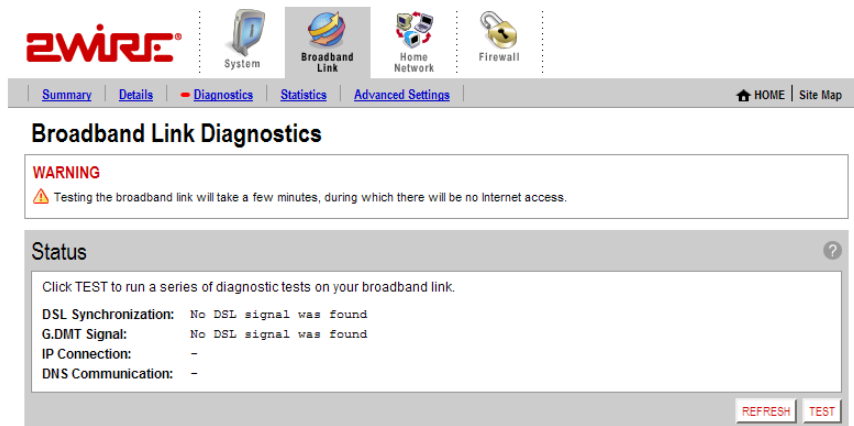

The screenshot shows the Z-Wire Gateway User Interface. At the top, there is a navigation menu with links for Summary, Details, Diagnostics (highlighted), Statistics, and Advanced Settings. Below the menu, there are icons for System, Broadband Link, Home Network, and Firewall. The main content area is titled "Broadband Link Diagnostics" and contains a warning message: "WARNING: Testing the broadband link will take a few minutes, during which there will be no Internet access." Below the warning is a "Status" section with a question mark icon. The status section contains the following text: "Click TEST to run a series of diagnostic tests on your broadband link." followed by a list of diagnostic results: "DSL Synchronization: No DSL signal was found", "G.DMT Signal: No DSL signal was found", "IP Connection: -", and "DNS Communication: -". At the bottom right of the status section, there are two buttons: "REFRESH" and "TEST".

To update the broadband link status, click **REFRESH**.

To initiate a full test of your broadband link, click **TEST**. The test will take several minutes, during which the system reestablishes all broadband connections. You will not be able to access the broadband network until the test is complete.

Viewing Statistics

The View Broadband Link Statistics page shows statistics associated with the 2Wire gateway broadband link, including cumulative DSL statistics.

2Wire System Broadband Link Home Network Firewall

Summary Details Diagnostics **Statistics** Advanced Settings HOME Site Map

View Broadband Link Statistics

Data Errors ?

Statistics
Collected for 0:11:46

	Since Reset	Current 24-Hour Interval	Current 15-Minute Interval	Time Since Last Event
DSL Link Retrains:	0	0	0	0:00:00
DSL Training Errors:	0	0	0	0:00:00
DSL Training Timeouts:	0	0	0	0:00:00
DSL Loss of Framing Failures:	0	0	0	0:00:00
DSL Loss of Signal Failures:	0	0	0	0:00:00
DSL Loss of Power Failures:	0	0	0	0:00:00
DSL Loss of Margin Failures:	0	0	0	0:00:00
DSL Cumulative Errored Seconds:	0	0	0	0:00:00
DSL Severely Errored Seconds:	0	0	0	0:00:00
DSL Corrected Blocks:	0	0	0	0:00:00
DSL Uncorrected Blocks:	0	0	0	0:00:00



Note: This page is not available for Ethernet broadband connections. When it is temporarily displayed in menu bars (immediately after changing from a DSL configuration), it will not contain any information.

Using Broadband Link Advanced Settings

The Advanced Settings page allows you to manually configure your DSL and Internet connection settings. Typically, these settings are automatically provided by your service provider. You should adjust these settings **ONLY** if you are very familiar with DSL and networking technology.

The screenshot shows the Z-Wire Gateway User Interface. At the top, there is a navigation bar with the Z-Wire logo and icons for System, Broadband Link, Home Network, and Firewall. Below the navigation bar, the page title is "Broadband Link Advanced Settings". A warning message is displayed: "WARNING: Modifying the settings on this page can impact the ability of computers on the local network to access your broadband connection. Modifications may also affect broadband-enabled applications and services running on the local network." The settings section is titled "Settings" and contains two main sections: "Broadband Type" and "DSL Settings". The "Broadband Type" section has a dropdown menu set to "DSL" and an "UPDATE" button. The "DSL Settings" section has a dropdown menu set to "Automatic" and "SAVE" and "CANCEL" buttons at the bottom right.

- Selecting Broadband Connection. The Broadband Type dropdown menu allows you to select whether to connect via DSL or Ethernet.
- Modifying DSL Settings. When your gateway is configured to use DSL, the gateway can be configured as to which DSL line port to use. By default, the gateway automatically detects which DSL line to use. The DSL Line Selection dropdown menu allows you to select a DSL line (Automatic, RJ-11, or CoAX).

Home Network Pages

Viewing Your Home Network Summary

The Home Network Summary page displays information about the devices installed on your network.

The screenshot shows the 2WIRE Gateway User Interface. At the top, there are navigation tabs: Summary (selected), Wireless Settings, and Advanced Settings. Below the tabs are icons for System, Broadband Link, Home Network, and Firewall. The main content area is titled 'View Network Summary' and contains two panels:

- Local Devices:** This panel lists two devices:
 - bart:** Status: Inactive. For this computer, there are links for 'Edit firewall settings' and 'View device details'.
 - RMARVIN:** Status: Active. For this computer, there are links for 'Edit firewall settings' and 'View device details'.
- Status at a Glance:** This panel provides a quick overview of the network status:
 - Home Network:** Local Interfaces: Ethernet: 1, Wireless: 0, USB: 0, MoCA: 0. Each interface has a 'DISABLE' button.
 - Wireless Settings:** Network Name: 2WIRE324, Access Point: 00:12:88:dd:ca:d9. There is an 'EDIT SETTINGS' button.

Local Devices

The Local Devices panel shows you the name of the device, how it is connected, any special configuration information, and provides links to other system features that you can set up for the device. A “device” on your network is usually a computer — either a personal computer used by a household member, or a computer that is dedicated to a specific use (such as a Web server that hosts online games). The status of each device is shown in the Local Devices list.

Each device on your home network is represented with a computer icon. If the “show inactive devices” option is enabled, and the device becomes inactive because it is powered off or removed from your network, this icon will display as Inactive.

If you defined a name for your computer during System Setup or when your computer was set up, the name displays next to the device. However, there are two instances where the device name will not appear:

- If your computer was manually configured with a static IP address, the static IP address displays instead of the computer’s name.
- If you have not named the device but it still obtains its Internet address from the system, the word “Unknown” displays.

If you have configured the firewall to allow information from the Internet to pass through to the computer (also referred to as “hosting an application”), the name of the application(s) that you are hosting are displayed under the device name.

Depending on the permissions you have set for devices on your network, the following links may display next to the device:

- **Access shared files.** Accesses the shared files available from this computer. This feature only works with Microsoft Windows computers that have shared files and file sharing installed. *If your computer is configured with a static IP address, this link will not appear.*
- **Edit firewall settings.** Accesses the system user interface page, which allows you to edit the firewall pass-through settings for the computer. For example, you may need to change the pass-through settings for the computer if you want to play an Internet game.
- **View Internet Access Control.** Accesses the Internet Access Restriction schedule for this computer.
- **Edit Content Screening.** Accesses the Content Screening settings page, allowing you to change the Web site permissions for users on your network.
- **View device details.** Displays the technical networking details about the device. This information may be helpful to a technical support representative if you are experiencing difficulties.

Note: Depending on the enhanced services offered by your service provider, some links (such as Internet Access Control or Content Screening) may not be available.

Status at a Glance Panel

The Status at a Glance panel shows you a list of network connection types, the number of devices connected via each connection type, and your wireless settings. To change your wireless settings, click the **EDIT SETTINGS** button. To disable a network device, click the **DISABLE** button.

Monitoring Your Wireless Settings

Your 2Wire gateway has an integrated wireless access point, which enables you to connect your wireless-enabled computers to your home network.



By default, the 2Wire gateway ships with WPA enabled and a preconfigured network name. The default WPA key is located on the bottom of the gateway, next to the serial number.

The screenshot shows the 'Configure the Wireless Network' page. At the top, there are navigation tabs: Summary, Wireless Settings (selected), and Advanced Settings. Below the tabs are icons for System, Broadband Link, Home Network, and Firewall. The main content area is split into two panels:

- Settings Panel:**
 - Identify Network:** Network Name is '2WIRE324', Wireless Channel is '6 (2437 MHz)'. There is a checked checkbox for 'Enable SSID Broadcast' with a descriptive paragraph below it.
 - Wireless Security:** There is a checked checkbox for 'Enable Wireless Network Security'. Authentication is set to 'WEP-Open'. There are radio buttons for 'Use default encryption key' (selected) and 'Use custom encryption key'. A 'Key:' field is present.
 - Additional Settings (defaults recommended):** Wireless Mode is '802.11b/g', DTIM Period (seconds) is '1', Maximum Connection Rate is '54 Mbps', and Power Setting is '4'.
- Current Settings Panel:**
 - Access Point: 00:12:88:dd:ca:d9
 - Network Name: 2WIRE324
 - Channel: 6 (2437 MHz)
 - Authentication: WEP-Open
 - Encryption: WEP

Below the settings is a note: 'To locate the built-in, 10-digit wireless encryption key for your system, please look at the bottom of the product near the bar code label.' An image of the gateway's bottom panel is shown with a circular callout highlighting a barcode. The barcode contains the text: 'SN: 14551100110', '4119627022', and 'Assembly Number: 4300-000428-000'. A label 'Default Encryption Key' points to the 10-digit number '4119627022'.

The Current Settings panel shows the 2Wire gateway's wireless access point settings:

- Access Point. The designated name of the wireless access point.
- Network Name. The name assigned to your wireless network. The default is 2WIREXXX, where XXX represents the last three digits of your 2Wire gateway serial number (for example, 2WIRE954).
- Channel. The radio frequency band the access point uses for your wireless network (the default is 6). Wireless adapter cards auto-detect which channels to use. If you are having problems with your wireless network, it could be due to radio interference. You can change the wireless channel to see if interference is reduced on a different channel.
- Authentication. The security method used to ensure that users are authorized to access the wireless network: WEP - Open, WEP - Shared, or WPA-PSK.
- Encryption. The security setting that makes it difficult for unauthorized users to access your network.

Customizing Security Settings

You should always enable encryption for wireless communication. When encryption is enabled, you must define an encryption key for the 2Wire gateway's wireless access point and configure that same key on each wireless client that will use your 2Wire gateway wireless network.



Note: If encryption is enabled, each wireless client must be configured with the encryption key defined on the system before it can operate on your wireless network.

Configuring Additional Settings

The Additional Settings panel allows you to customize wireless settings. In general, it is recommended that you leave the default settings in place; however, if you are experiencing connection or performance difficulties, altering these settings may improve performance.



Note: Because the fields that display are dependent on the type of wireless adapter you are using, some of these settings may not display.

- **Wireless Mode.** Allows you to force the gateway to use 802.11b/g, 802.11b-only, or 802.11g-only modes of operation.
- **DTIM Period (seconds).** Determines at which interval the access point will send its broadcast traffic. *This field displays only for 802.11b/g based models.*
- **Maximum Connection Rate.** The maximum rate at which your wireless connection works (1, 2, 5.5, 11, or 22 Mbps for 802.11b-based models; 1, 2, 5.5, 11, 6, 9, 12, 24, 36, 48, or 54 Mbps for 802.11b/g-based models).
- **Power Setting.** Allows you to select the power level for your wireless connection. Power level options are based on the service provider's configuration.

If you have customized your wireless system configuration, you can restore the wireless settings to factory defaults by clicking the **RESTORE DEFAULTS** button.



Configuring Advanced Settings

The Edit Advanced Home Network Settings page displays the current IP settings in use by your system for your home network, and allows you to configure your home network settings. You should adjust these settings **ONLY** if you are very familiar with computer networking technologies.

zWIRE System Broadband Link Home Network Firewall

Summary Wireless Settings **Advanced Settings** HOME Site Map

Edit Advanced Home Network Settings

WARNING
 ⚠ Modifying the settings on this page can impact the ability of computers on the local network to access your broadband connection. Modifications may also affect broadband-enabled applications and services running on the local network.

Settings

Private Network

If you change the IP address range, you must renew the DHCP lease on all devices on the network.

192.168.1.0 / 255.255.255.0 (default)
 172.16.0.0 / 255.255.0.0
 10.0.0.0 / 255.255.0.0
 Configure manually

Router Address:

Subnet Mask:

Enable DHCP

First DHCP Address:

Last DHCP Address:

Set DHCP Lease Time: hours

Display Settings

Show inactive devices in network list

SAVE CANCEL

Current Settings

Private Network

Router Address: 192.168.1.254

Subnet Mask: 255.255.255.0

DHCP Range: 192.168.1.64 - 192.168.1.253

Allocated: 2

Available: 188

Device List

bart	192.168.1.64
RMYARVIN	192.168.1.65

EDIT ADDRESS ALLOCATION

The Current Settings panel shows the following information:

- Router Address. The IP address used by your gateway on the private home network (the default is 192.168.1.254). The gateway has two IP addresses: a private address that it uses on the home network, and one that is used on the public broadband connection on the Internet. You can change the home network IP address by changing the home network IP address range.
- Subnet Mask. The subnet mask is determined by the home network IP address range settings (the default is 255.255.255.0).
- DHCP Range. The range of IP addresses used by your system (the default is 192.168.1.33 through 192.168.1.250). IP addresses can be either static (permanently assigned) or dynamic (automatic and temporary).

Editing Address Allocation Settings

The Current Settings panel displays the computers currently on the local network, and their IP address. It also indicates whether a given computer is receiving its IP address via DHCP or has been manually entered into the computer (static).

If users enable the Public Network feature, they can choose to have their broadband accessible (non-NAT) IP addresses assigned automatically via DHCP to computers on the local network. To do so:

1. Click the **Edit Address Allocation** button. The Edit Address Allocation Settings page opens.

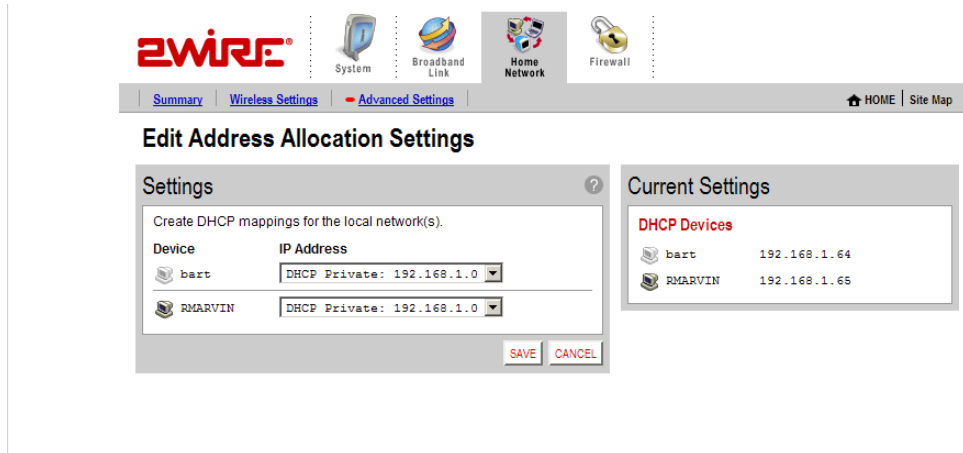

2. In the Settings panel, select an available IP address from the pulldown menu next to the computer to which you want an IP address automatically assigned.
3. Click **Save**.

Users can choose to have the address assigned from any of the available networks. Computers that are assigned non-routable (private network) addresses will use Network Address Translation (NAT) to access the internet. Selecting a “DHCP Fixed” entry instructs the gateway to always provide the same address from the DHCP pool to the specified computer.

Computers on the Public Network are still behind the firewall. To allow inbound traffic to these computers, the firewall settings specified for that computer must be modified.

Firewall Pages

The 2Wire gateway has a professional-grade firewall to help prevent unauthorized users from accessing your local network. The 2Wire gateway firewall includes the following features:

- Stateful packet inspection. Blocks common Denial of Service attacks (such as SYN/FIN flooding or Smurf), and detects and logs TCP and UDP port scans.
- Stateless packet inspection. Filters specific NetBios traffic, suspicious packets and IP fragments; blocks packets sent from the private network to the Internet that have spoofed IP addresses.
- Network Address Translation (NAT). Translates a local network's IP address to an external address maintained by the 2Wire gateway, effectively "hiding" the existence of a home network to the Internet. The 2Wire gateway then uses this external address to communicate with the Internet on behalf of devices connected to the local network.
- Port Address Translation (PAT). A function provided by some routers which allows hosts on a LAN to communicate with the rest of a network (such as the Internet) without revealing their own private IP address. All outbound packets have their IP address translated to the router's external IP address. Replies come back to the router, which then translates them back into the private IP address of the original host for final delivery. During PAT, each computer on the LAN is translated to the same IP address, but with a different port number assignment.
- Inbound and outbound port blocking. Blocks common inbound and outbound protocol types from passing information to or receiving information from the Internet.

Viewing Your Firewall Summary

The Firewall Summary page provides summary information and links to the most commonly used security-related features of your system.

The screenshot displays the 2Wire Gateway User Interface. At the top, there is a navigation bar with the 2Wire logo and four tabs: System, Broadband Link, Home Network, and Firewall. The Firewall tab is selected. Below the navigation bar, there is a breadcrumb trail: Summary | Firewall Settings | Advanced Settings. A HOME button and Site Map link are also visible. The main content area is titled "View Firewall Summary". Underneath, there is a "Firewall Settings" section. It features a shield icon and the text "Firewall Active". The text explains that the firewall blocks unwanted activity and provides instructions on how to open ports. It also shows the current settings are "Default" and provides instructions on how to configure settings for connecting to a computer on the local network. A "VIEW DETAILS" link is located at the bottom right of the settings box.

The Firewall Settings panel displays the Current Settings for your firewall.

- Default. Unsolicited inbound traffic is not allowed to pass through the firewall.
- Custom. Applications are associated with computers on your network.

An access list shows the computers (Devices) on your network and the names of the Allowed Applications for each computer. When you allow application traffic, external users on the Internet can have limited access to your home network. This access might be required to allow some programs (such as game servers or instant messaging software) to operate properly.

For example, a remote game player on the Internet might need to contact the game server program that you have installed on your home network in order to play against you. Normally, the firewall blocks this communication. By changing the firewall settings, this communication is permitted to pass through a “pinhole” in the firewall. This function may be referred to as “port-mapping” or “port-forwarding” in your software program documentation.

Click **VIEW DETAILS** to access the Firewall Details page, which shows a list of all the devices that have applications configured in the firewall and the details of these configurations.



Configuring Firewall Settings

The Edit Firewall Settings page allows you to open select ports, or “pinholes” in the firewall.

2WIRE System Broadband Link Home Network Firewall

Summary **Firewall Settings** Advanced Settings HOME Site Map

Edit Firewall Settings

Settings

By default, the firewall blocks all unwanted access from the Internet. You can allow access from the Internet to applications running on computers inside your secure home network by enabling firewall pinholes. Opening firewall pinholes is also known as opening firewall ports or firewall port forwarding. To do this, associate the desired application with the computer below. If you cannot find a listing for your application, you can create a user-defined application profile. (To create a user-defined profile, you will need to know protocol and port information.)

- [View firewall details](#)
- [Reset all firewall settings](#)

To Allow Users Through the Firewall to Hosted Applications...

- Select a computer**
Choose the computer that will host applications through the firewall:
- Edit firewall settings for this computer:**
 - Maximum protection** – Disallow unsolicited inbound traffic.
 - Allow individual application(s)** – Choose the application(s) that will be enabled to pass through the firewall to this computer. Click ADD to add it to the Hosted Applications list.

All applications	Hosted Applications:
Age of Empires	
Age of Kings	
Age of Wonders	
Aliens vs Predator	
Anarchy Online	
Asheron's Call	
Baldur's Gate	
BattleCom	
Battlefield Communicator	
Black and White	
 - Allow all applications (DMZplus mode)** – Set the selected computer in DMZplus mode. All inbound traffic, except traffic which has been specifically assigned to another computer using the “Allow individual applications” feature, will automatically be directed to this computer. The DMZplus-enabled computer is less secure because all unassigned firewall ports are opened for that computer.

Note: Once DMZplus mode is selected and you click DONE, the system will issue a new IP address to the selected computer. The computer must be set to DHCP mode to receive the new IP address from the system, and you must reboot the computer. If you are changing DMZplus mode from one computer to another computer, you must reboot both computers.

DONE

You can allow individual applications, or use DMZplus mode. When in DMZplus mode, the designated computer:

- Shares your gateway's IP address (Router Address).
- Appears as if it is directly connected to the Internet.
- Has all of the unassigned TCP and UDP ports opened and pointed to it.
- Can receive unsolicited network traffic from the Internet.

Because all filtered traffic is forwarded to the designated computer, you should use DMZplus mode with caution. A computer in DMZplus mode is less secure because all available ports are open and all incoming Internet traffic is directed to this computer.

Configuring Advanced Firewall Settings

The Edit Advanced Firewall Settings page allows you to configure advanced features on your firewall.

2Wire System Broadband Link Home Network Firewall

Summary Firewall Settings **Advanced Settings** HOME Site Map

Edit Advanced Firewall Settings

WARNING
 ⚠ Modifying the settings on this page can impact the ability of computers on the local network to access your broadband connection. Modifications may also affect broadband-enabled applications and services running on the local network.

Settings

Security ?
 Check to enable the features below:
 Stealth Mode
 Block Ping
 Strict UDP Session Control

Outbound Control ?
 Checking the box allows the associated traffic type through the firewall.

Outbound

HTTP
 HTTPS
 FTP
 Telnet
 SMTP
 DNS
 NetBIOS
 POP3
 IMAP
 NNTP
 IRC
 H323
 All Other Protocols

SAVE CANCEL RESTORE DEFAULTS

Instructions

Limiting data traffic may disable support for hosted applications that require inbound communications such as Web servers, games, or Internet chat programs. All data traffic will continue to be scanned by the firewall for known hacker attacks.

Attack Detection ?

Check to detect the types of attacks below:

Excessive Session Detection
 TCP/UDP Port Scan
 Invalid Source/Destination IP address
 Packet Flood (SYN/UDP/ICMP/Other)
 Invalid TCP Flag Attacks (NULL/XMAS/Other)
 Invalid ICMP Detection
 Miscellaneous

SAVE CANCEL

Enabling Advanced Security

The 2Wire gateway firewall already provides a high level of security. You can configure the firewall to provide advanced security features, including stealth mode, strict UDP, or block pings.

- **Stealth Mode.** When in stealth mode, the 2Wire gateway firewall does not return information in response to network queries; that is, it will appear to hackers who are trying to access your network that your network does not exist. This discourages hackers from further attempts at accessing your network, because to them it will appear as though there is no active network to access.
- **Block Ping.** Ping is a basic Internet program that, when used without malicious intent, allows a user to verify that a particular IP address exists and can accept requests. Hackers can use ping to launch an attack against your network, because ping can determine the number form of the network's IP address (for example, 105.246.172.72) from the domain name (for example, www.mynetwork.com). If you enable Block Ping, your network will block all ping requests.

- **Strict UDP Session Control.** Enabling this feature provides increased security by preventing the 2Wire gateway from accepting packets sent from an unknown source over an existing connection. *The ability to send traffic based on destination only is required by some applications. Enabling this feature may not allow some on-line applications to work properly.*

Allowing Inbound and Outbound Traffic

The Inbound and Outbound Control pane displays some common protocol types. When one of the Inbound protocol boxes is checked, the firewall allows the corresponding protocol to pass through from the Internet to the network. If one of the Outbound protocol boxes is checked, the firewall allows the traffic from the network to pass through the firewall to the Internet.



Note: If you configure the firewall to block an Inbound protocol, you may disable support for hosted applications that require that type of protocol.

Disabling Attack Detection

By default, the 2Wire gateway firewall rules block the attack types listed in the Attack Detection pane. There are some applications and devices that require the use of specific data ports through the firewall. The gateway allows users to open the necessary ports through the firewall using the Firewall Settings page. If the user requires that a computer have all incoming traffic available to it, this computer can be set to the DMZplus mode. While in DMZplus mode, the computer is still protected against numerous broadband attacks (for example, SYN Flood or Invalid TCP flag attacks).

In rare cases, the incoming traffic may be inadvertently blocked by the firewall (for example, when integrating with external third-party firewalls or VPN servers). You may need to disable one or more of the attack detection capabilities for any device placed in the DMZplus. In this case, the third-party server provides the attack protection normally provided by the gateway.

Following are the attacks for which the gateway firewall filters continuously checks.

- **Excessive Session Detection.** When enabled, the firewall will detect applications on the local network that are creating excessive sessions out to the Internet. This activity is likely due to a virus or “worm” infected computer (for example, Blaster Worm). When the event is detected, the gateway displays a HURL warning page.
- **TCP/UDP Port Scan.** A port scan is a series of messages sent by someone attempting to break into a computer to learn which computer network services, each associated with a well-known port number (such as UDP and TCP), the computer provides. When enabled, the firewall detects UDP and TCP port scans, and drops the packet.
- **Invalid Source/Destination IP address.** When enabled, the firewall will verify IP addresses by checking for the following:
 - IP source address is broadcast or multicast — drop packet.
 - TCP destination IP address is not unicast — drop packet.
 - IP source and destination address are the same — drop packet.
 - Invalid IP source received from private/home network — drop packet.



- Packet Flood (SYN/UDP/ICMP/Other). When enabled, the firewall will check for SYN, UDP, ICMP, and other types of packet floods on the local and Internet facing interfaces and stop the flood.
- Invalid TCP Flag Attacks (NULL/XMAS/Other). When enabled, the firewall will scan inbound and outbound packets for invalid TCP Flag settings, and drop the packet to prevent SYN/FIN, NULL, and XMAS attacks.
- Invalid ICMP Detection. The firewall checks for invalid ICMP/code types, and drops the packet.
- Miscellaneous. The firewall checks for the following:
 - Unknown IP protocol — drop packet.
 - Port 0 attack detected — drop packet.
 - TCP SYN packet — drop packet.
 - Not a start session packet — drop packet.
 - ICMP destination unreachable — terminate session.

Access the Management and Diagnostic Console

Accessing the Management and Diagnostic Console

The Management and Diagnostic Console (MDC) provides information about the status of the 2Wire gateway, its broadband network connections, attached home networking devices, system and security information, and a running log of any error conditions.

To access the MDC locally, in the browser address bar enter `http://gateway.2wire.net/management`.

After you access the MDC, use the left-hand navigation menu to select specific MDC pages.

System Summary Page

The System Summary page shows general information about the 2Wire gateway, its configuration, and components.

The screenshot shows the 2Wire Management and Diagnostic Console interface. On the left is a navigation menu with categories like Broadband Link, Local Network, Firewall, Troubleshooting, and Advanced. The main content area is titled 'System Summary' and is divided into four sections: System, Configuration, Components, and Features, each listing various system parameters and their values.

2WIRE Management and Diagnostic Console

System Summary

System

Model:	3700HGV-B Gateway
Serial Number:	315114005324
MAC Address:	00:12:88:dd:ca:d8
Hardware Version:	2700-000499-001
Hardware Options:	Wireless present
DSL Modem Type:	VDSL
Current Software:	4.23.17

Configuration

Key Code:	52HP-2374-2262-22AT-B2KR
System Time:	Retrieving date and time settings from the Internet...
Time Since Last Boot:	0 days 00:20:01
Last ID Post:	-

Components

DSL Modem:	0.97.3-A1 SW:8.18.050817
system:	43133
base_ui:	43134
common_en:	43136
base_voice:	43135
sbc-trial_config:	43150
sbc-lightspeed_en:	43151
sbc-lightspeed:	43152
Firewall Rules:	1000
Application List:	1001

Features

IGMP Proxy:	Enabled
IGMP Snooping:	Enabled
IGMP Querier:	Enabled
Fwrd Multicast:	Enabled

Item	Description
Features	

Broadband Link - Summary Page

The Broadband Link - Summary page allows you to view 2Wire gateway broadband connectivity-related settings, and reset the Broadband Link and IP Connection.

Management and Diagnostic Console

[System Summary](#)

Broadband Link

- [Summary](#)
- [Statistics](#)
- [Detailed Statistics](#)
- [Configure](#)

Local Network

- [Status](#)
- [Statistics](#)
- [Device List](#)
- [Wireless](#)
- [Configure](#)
- [Address Allocation](#)
- [MoCA](#)
- [MoCA Statistics](#)

Firewall

- [Settings](#)
- [Detailed Information](#)
- [Advanced Settings](#)

Troubleshooting

- [DSL Diagnostics](#)
- [Event Log](#)
- [Network Tests](#)
- [Upgrade History](#)
- [Resets](#)

Advanced

- [Syslog Settings](#)
- [Provisioning Info](#)
- [Configure Time Services](#)
- [Configure Services](#)
- [DNS Resolve](#)
- [Link Manager](#)
- [Detailed Log](#)

Broadband Link – Summary

Connection Information

Broadband Connection: Built in modem - VDSL
 Current Status: No Physical Link Signal

DSL Connection Details [RESET](#) | [Broadband Link](#)

DSL Line (Wire Pair): Search for DSL signal
 Protocol: --
 DSL Channel: (none)
 DSLAM: Country: {-} Vendor: {-} Specific: {-}

IP Details [RESET](#) | [IP Connection](#)

Connection Type: Direct IP (DHCP or Static)
 IP Address Range: --
 Subnet Mask: --
 Gateway: --
 Primary DNS: --
 Secondary DNS: --
 Host Name: --
 Domain Name: --
 MTU: --
 Spoof MAC Address: --



Note: The information displayed varies depending on whether the broadband connection is via DSL or Ethernet.

Broadband Link - Statistics Page

The Broadband Link - Statistics page shows statistics associated with the 2Wire gateway broadband link.



- [System Summary](#)
- Broadband Link**
 - [Summary](#)
 - [Statistics](#)
 - [Detailed Statistics](#)
 - [Configure](#)
- Local Network**
 - [Status](#)
 - [Statistics](#)
 - [Device List](#)
 - [Wireless](#)
 - [Configure](#)
 - [Address Allocation](#)
 - [MoCA](#)
 - [MoCA Statistics](#)
- Firewall**
 - [Settings](#)
 - [Detailed Information](#)
 - [Advanced Settings](#)
- Troubleshooting**
 - [DSL Diagnostics](#)
 - [Event Log](#)
 - [Network Tests](#)
 - [Upgrade History](#)
 - [Resets](#)
- Advanced**
 - [Syslog Settings](#)
 - [Provisioning Info](#)
 - [Configure Time Services](#)
 - [Configure Services](#)
 - [DNS Resolve](#)
 - [Link Manager](#)
 - [Detailed Log](#)

Broadband Link – Statistics

DSL	Down	Up
Current Rate:	0 kbs	0 kbs
Max Rate:	0 kbs	Not Available
Current Connection:		
Current Noise Margin:	0.0 dB	Not Available
Current Attenuation:	0.0 dB	Not Available
Current Output Power:	0.0 dB	0.0 dB

Broadband Link - Detailed Statistics Page

The Broadband Link – Detailed DSL Statistics page shows a set of cumulative DSL statistics associated with the 2Wire gateway.



[System Summary](#)

Broadband Link

- [Summary](#)
- [Statistics](#)
- [Detailed Statistics](#)
- [Configure](#)

Local Network

- [Status](#)
- [Statistics](#)
- [Device List](#)
- [Wireless](#)
- [Configure](#)
- [Address Allocation](#)
- [MoCA](#)
- [MoCA Statistics](#)

Firewall

- [Settings](#)
- [Detailed Information](#)
- [Advanced Settings](#)

Troubleshooting

- [DSL Diagnostics](#)
- [Event Log](#)
- [Network Tests](#)
- [Upgrade History](#)
- [Resets](#)

Advanced

- [Syslog Settings](#)
- [Provisioning Info](#)
- [Configure Time Services](#)
- [Configure Services](#)
- [DNS Resolve](#)
- [Link Manager](#)
- [Detailed Log](#)

Broadband Link – Detailed DSL Statistics

[RESET](#) [Statistics](#)

Collected for 0:23:48

DSL

	Since Reset	Current 24-Hour Interval	Current 15-Minute Interval	Time Since Last Event
Link Retrains:	0	0	0	0:00:00
DSL Training Errors:	0	0	0	0:00:00
Training Timeouts:	0	0	0	0:00:00
Loss of Framing Failures:	0	0	0	0:00:00
Loss of Signal Failures:	0	0	0	0:00:00
Loss of Margin Failures:	0	0	0	0:00:00
Cumulative Seconds w/Errors:	0	0	0	0:00:00
Cumulative Sec. w/Severe Errors:	0	0	0	0:00:00
Corrected Blocks:	0	0	0	0:00:00
Uncorrectable Blocks:	0	0	0	0:00:00
DSL Unavailable Seconds:	1424	1424	523	0:00:00

Broadband Link - Configuration Page

The Broadband Link – Configuration page allows you to modify specific broadband connection settings.

The screenshot shows the 'Broadband Link - Configuration Page' in the 'Management and Diagnostic Console'. The page features a left-hand navigation menu with categories: System Summary, Broadband Link (with sub-items: Summary, Statistics, Detailed Statistics, Configure), Local Network (with sub-items: Status, Statistics, Device List, Wireless, Configure, Address Allocation, MoCA, MoCA Statistics), Firewall (with sub-items: Settings, Detailed Information, Advanced Settings), Troubleshooting (with sub-items: DSL Diagnostics, Event Log, Network Tests, Upgrade History, Resets), and Advanced (with sub-items: Syslog Settings, Provisioning Info, Configure Time Services, Configure Services, DNS Resolve, Link Manager, Detailed Log). The main content area has a 'WARNING' box stating that changes can impact local network access. Below this, the 'Broadband Type' is set to 'DSL' with an 'UPDATE' button. The 'DSL Settings' section shows 'DSL Line Selection' set to 'Automatic' with a 'SUBMIT Settings' button. A 'Back to Top' link is also present.

For details on broadband link configuration settings, refer to “Using Broadband Link Advanced Settings” on page 19.

Local Network - Status Page

The Local Network – Status page shows the status of the local network.

2WIRE Management and Diagnostic Console

Local Network – Status

IP

Gateway: 192.168.1.254
 IP Network: 192.168.1.0
 Subnet Mask: 255.255.255.0
 DHCP Range: 192.168.1.64 – 192.168.1.253
 Allocated: 2
 Remaining: 188
 DHCP Timeout: 1440 minutes

Devices

	Active	Inactive	Mode
Ethernet:	1	1	
Wireless (802.11):	0	0	
USB:	0	--	
MoCA:	0	0	

The Local Network – Status page includes the following information:

Item	Description
IP	
Gateway	The IP address allocated to the 2Wire gateway.
IP Network	The IP address used by the network.
Subnet Mask	The subnet mask allocated to the 2Wire gateway.
DHCP Range	The range of IP addresses available on the network, the number of addresses allocated, and the number of addresses remaining.
DHCP Timeout	The time, in minutes, before the DHCP lease must be renewed.
Wireless (this field is present only on wireless 2Wire gateway models)	

Item	Description
Network Name	The default setting is the word "2WIRE," followed by the last three digits of the 2Wire gateway serial number.
Authentication	The authentication method used: Open, Shared, or WPA-PSK (Wi-Fi Protected Access pre-shared key).
Encryption	The encryption method used: WEP or TKIP.
Channel	The frequency channel in use. The default channel is 6. If multiple access devices within the vicinity use the same channel, you can set a different channel to eliminate potential interference.
Devices (the information displayed is dependent on the gateway model features)	
Ethernet	The number of Active and Inactive Ethernet devices on the network.
Wireless (802.11)	The number of Active and Inactive wireless devices on the network.
HomePNA	The number of Active and Inactive HomePNA devices on the network.
USB	Specifies whether a USB device is present (Active) on the network. If a USB device is not present, the value is Inactive.
MoCA	The number of Active and Inactive MoCA devices on the network.
Public Network	
Router Address	Defines a separate network on the home side.
Subnet Mask	The subnet mask allocated for public address.

Local Network - Statistics Page

Note: The information displayed is dependent on gateway model features.

The Local Network – Statistics page shows information about the interfaces on the local network.

Management and Diagnostic Console

[System Summary](#)

Broadband Link

- [Summary](#)
- [Statistics](#)
- [Detailed Statistics](#)
- [Configure](#)

Local Network

- [Status](#)
- [Statistics](#)
- [Device List](#)
- [Wireless](#)
- [Configure](#)
- [Address Allocation](#)
- [MoCA](#)
- [MoCA Statistics](#)

Firewall

- [Settings](#)
- [Detailed Information](#)
- [Advanced Settings](#)

Troubleshooting

- [DSL Diagnostics](#)
- [Event Log](#)
- [Network Tests](#)
- [Upgrade History](#)
- [Resets](#)

Advanced

- [System Settings](#)
- [Provisioning Info](#)
- [Configure Time Services](#)
- [Configure Services](#)
- [DNS Resolve](#)
- [Link Manager](#)
- [Detailed Log](#)

Local Network – Statistics [RESET](#) [Statistics](#)

Ethernet	Bytes	Packets	Errors	%	
Transmit:	2700834	14230	0	0	
Receive:	3179684	17706	0	0	
<hr/>					
Wireless					
Transmit:	38076	0	176	0	
Receive:	78880065	0	0	0	
<hr/>					
USB					
Transmit:	0	0	0	0	
Receive:	0	0	0	0	
<hr/>					
MoCA					
Transmit:	0	1011	0	0	
Receive:	0	0	0	0	
<hr/>					
MoCA	Frames Sent	Frames Received	Frames Errored	RFOutputLevel	PacketDrop
Statistics:	1011	0	0	10	39219

Local Network - Device List Page

The Local Network - Device List page displays information about each device in the local network.



[System Summary](#)

Broadband Link

- [Summary](#)
- [Statistics](#)
- [Detailed Statistics](#)
- [Configure](#)

Local Network

- [Status](#)
- [Statistics](#)
- [Device List](#)
- [Wireless](#)
- [Configure](#)
- [Address Allocation](#)
- [MoCA](#)
- [MoCA Statistics](#)

Firewall

- [Settings](#)
- [Detailed Information](#)
- [Advanced Settings](#)

Troubleshooting

- [DSL Diagnostics](#)
- [Event Log](#)
- [Network Tests](#)
- [Upgrade History](#)
- [Resets](#)

Advanced

- [Syslog Settings](#)
- [Provisioning Info](#)
- [Configure Time Services](#)
- [Configure Services](#)
- [DNS Resolve](#)
- [Link Manager](#)
- [Detailed Log](#)

Local Network – Device List

Identity	Type	MAC Address	IP Address
System	--	00:12:88:dd:ca:d9	192.168.1.254
bart	Ethernet	00:90:27:af:40:9b	192.168.1.64
RMARVIN	Ethernet	00:0d:56:dd:e4:9f	192.168.1.65

Local Network - Wireless Settings Page

The Wireless Settings page allows you to view or modify the gateway's wireless settings.

2WIRE Management and Diagnostic Console

Local Network – Wireless Settings SUBMIT Settings

System Summary

- Broadband Link
 - Summary
 - Statistics
 - Detailed Statistics
 - Configure
- Local Network
 - Status
 - Statistics
 - Device List
 - Wireless
 - Configure
 - Address Allocation
 - MoCA
 - MoCA Statistics
- Firewall
 - Settings
 - Detailed Information
 - Advanced Settings
- Troubleshooting
 - DSL Diagnostics
 - Event Log
 - Network Tests
 - Upgrade History
 - Resets
- Advanced
 - Syslog Settings
 - Provisioning Info
 - Configure Time Services
 - Configure Services
 - DNS Resolve
 - Link Manager
 - Detailed Log

Current Settings

Access Point: 00:12:88:dd:ca:d9
 Network Name: 2WIRE324
 Channel: 6 (2437 MHz)
 Authentication: WEP-Open
 Encryption: WEP

Settings

Network Name:
 Wireless Channel:
 Enable SSID Broadcast:

Wireless Security

Enable Wireless Network Security:

Authentication:

Use default encryption key
 Use custom encryption key

Key:

Additional Settings (defaults recommended)

Wireless Mode: Default: 802.11b/g
 DTIM Period (seconds): Default: 1
 Power Setting: Default: 4
 Maximum Connection Rate: Default: 54 Mbps

SUBMIT Settings

[Back to Top](#)

For details on configuring wireless settings, refer to page 23.

Local Network - Configuration Page

The Local Network - Configuration page allows you to change the gateway's default local network settings. You must click the **Submit** button for changes to take effect.

The screenshot shows the 'Local Network - Configuration' page in the 2Wire Management and Diagnostic Console. On the left is a navigation menu with categories: System Summary, Broadband Link, Local Network, Firewall, Troubleshooting, and Advanced. The main content area is titled 'Local Network - Configuration' and includes a 'SUBMIT Settings' button. A 'WARNING' box states that modifying settings can impact network access. Under 'Private Network', there are radio buttons for three IP address ranges: 192.168.1.0 / 255.255.255.0 (selected), 172.16.0.0 / 255.255.0.0, and 10.0.0.0 / 255.255.0.0. Below these are fields for 'Configure manually' (Router Address, Subnet Mask), a checkbox for 'Enable DHCP', and fields for 'First DHCP Address' and 'Last DHCP Address'. A 'Set DHCP Lease Time' field is set to 24 hours. Under 'Display Settings', there is a checked checkbox for 'Show inactive devices in network list'. At the bottom, there is a checked checkbox for 'Enable Router behind Router alert' and another 'SUBMIT Settings' button. A 'Back to Top' link is also present.

For details on configuring advanced network settings, refer to page 24.

Enabling Router Behind Router Alert

When the **Display alert when another router is connected to this router** checkbox is enabled, an error page is displayed to the user if the gateway detects the presence of a third-party router on the user's network. A third-party router connected to the 2Wire gateway can result in network instability, because both devices are trying to manage private IPs via NAT.

Local Network - Address Allocation Page

The Local Network - Address Allocation page shows the name and IP address of each device on the gateway's local network, and allows you to create DHCP mappings for each device.

Z-WIRE Management and Diagnostic Console

Local Network – Address Allocation Settings

Create DHCP mappings for the local network(s).

Device	Current Settings	IP Address
bart	192.168.1.64	DHCP Private: 192.168.1.0
RMARVIN	192.168.1.65	DHCP Private: 192.168.1.0

System Summary

Broadband Link

- Summary
- Statistics
- Detailed Statistics
- Configure

Local Network

- Status
- Statistics
- Device List
- Wireless
- Configure
- Address Allocation
- MoCA
- MoCA Statistics

Firewall

- Settings
- Detailed Information
- Advanced Settings

Troubleshooting

- DSL Diagnostics
- Event Log
- Network Tests
- Upgrade History
- Resets

Advanced

- Syslog Settings
- Provisioning Info
- Configure Time Services
- Configure Services
- DNS Resolve
- Link Manager
- Detailed Log

For details on network address allocation, refer to “Editing Address Allocation Settings” on page 25.

Local Network - Configure the MoCA Network Page

The Configure the MoCA Network page allows you to change the channel upon which the MoCA signal is sent or received, enable or disable network privacy, and set the password for network privacy. These settings are only used when the gateway is connected via MoCA. When MoCA is used through external devices, these settings are not applicable.

Z-WIRE Management and Diagnostic Console

Configure the MoCA Network

Configure MoCA

Channel:

Privacy: Enable Disable

Password:

Network Coordinator:

[Back to Top](#)

- System Summary
- Broadband Link
 - Summary
 - Statistics
 - Detailed Statistics
 - Configure
- Local Network
 - Status
 - Statistics
 - Device List
 - Wireless
 - Configure
 - Address Allocation
 - MoCA
 - MoCA Statistics
- Firewall
 - Settings
 - Detailed Information
 - Advanced Settings
- Troubleshooting
 - DSL Diagnostics
 - Event Log
 - Network Tests
 - Upgrade History
 - Resets
- Advanced
 - Syslog Settings
 - Provisioning Info
 - Configure Time Services
 - Configure Services
 - DNS Resolve
 - Link Manager
 - Detailed Log

Local Network - MoCA Statistics Page

The MoCA Statistics page shows connection rates to other MoCA devices.



System Summary
Broadband Link
• Summary
• Statistics
• Detailed Statistics
• Configure
Local Network
• Status
• Statistics
• Device List
• Wireless
• Configure
• Address Allocation
• MoCA
• MoCA Statistics
Firewall
• Settings
• Detailed Information
• Advanced Settings
Troubleshooting
• DSL Diagnostics
• Event Log
• Network Tests
• Upgrade History
• Resets
Advanced
• Syslog Settings
• Provisioning Info
• Configure Time Services
• Configure Services
• DNS Resolve
• Link Manager
• Detailed Log

MoCA Statistics

Gateway: NETWORK COORDINATOR

Connected Nodes: None

- If the 3700HGV-B is the coordinator, the link rate to the slaves.
- If the 3700HGV-B is not the coordinator, the link rate to the coordinator.



Firewall - Settings Page

The Firewall - Settings page allows you to configure the firewall to pass through specific application data to a selected computer.

zWIRE Management and Diagnostic Console

Firewall - Settings SUBMIT Settings

By default, the firewall blocks all unwanted access from the Internet. You can allow access from the Internet to applications running on computers inside your secure home network by enabling firewall pinholes. Opening firewall pinholes is also known as opening firewall ports or firewall port forwarding. To do this, associate the desired application with the computer below. If you cannot find a listing for your application, you can create a user-defined application profile. (To create a user-defined profile, you will need to know protocol and port information.)

To Allow Users Through the Firewall to Hosted Applications...

- Select a computer**
Choose the computer that will host applications through the firewall:
- Edit firewall settings for this computer:**
 - Maximum protection** – Disallow unsolicited inbound traffic.
 - Allow individual application(s)** – Choose the application(s) that will be enabled to pass through the firewall to this computer. Click ADD to add it to the Hosted Applications list.

All applications

 - Age of Empires
 - Age of Kings
 - Age of Wonders
 - Aliens vs Predator
 - Anarchy Online
 - Asheron's Call
 - Baldur's Gate
 - BattleCom
 - Battlefield Communicator
 - Black and White

ADD

REMOVE

Hosted Applications:
 - Allow all applications (DMZplus mode)** – Set the selected computer in DMZplus mode. All inbound traffic, except traffic which has been specifically assigned to another computer using the "Allow individual applications" feature, will automatically be directed to this computer. The DMZplus-enabled computer is less secure because all unassigned firewall ports are opened for that computer.

Note: Once DMZplus mode is selected and you click DONE, the system will issue a new IP address to the selected computer. The computer must be set to DHCP mode to receive the new IP address from the system, and you must reboot the computer. If you are changing DMZplus mode from one computer to another computer, you must reboot both computers.

SUBMIT Settings

[Back to Top](#)

For details on configuring the firewall, refer to page 28.

Firewall - Detailed Information Page

The Firewall - Detailed Information page shows detailed information about the gateway's firewall.



- [System Summary](#)
- Broadband Link**
 - [Summary](#)
 - [Statistics](#)
 - [Detailed Statistics](#)
 - [Configure](#)
- Local Network**
 - [Status](#)
 - [Statistics](#)
 - [Device List](#)
 - [Wireless](#)
 - [Configure](#)
 - [Address Allocation](#)
 - [MoCA](#)
 - [MoCA Statistics](#)
- Firewall**
 - [Settings](#)
 - [Detailed Information](#)
 - [Advanced Settings](#)
- Troubleshooting**
 - [DSL Diagnostics](#)
 - [Event Log](#)
 - [Network Tests](#)
 - [Upgrade History](#)
 - [Resets](#)
- Advanced**
 - [Syslog Settings](#)
 - [Provisioning Info](#)
 - [Configure Time Services](#)
 - [Configure Services](#)
 - [DNS Resolve](#)
 - [Link Manager](#)
 - [Detailed Log](#)

Firewall – Detailed Information

Pinholes

external pin-holes (192 available):

NAT Sessions

current secs since boot: 3143
session table 1024/1024 available, 0/512 used in inbound sessions:

[Back to Top](#)

Firewall - Advanced Settings Page

The Firewall - Advanced Settings page allows you to configure the gateway's firewall.

2Wire Management and Diagnostic Console

System Summary

- Broadband Link
 - Summary
 - Statistics
 - Detailed Statistics
 - Configure
- Local Network
 - Status
 - Statistics
 - Device List
 - Wireless
 - Configure
 - Address Allocation
 - MoCA
 - MoCA Statistics
- Firewall
 - Settings
 - Detailed Information
 - Advanced Settings
- Troubleshooting
 - DSL Diagnostics
 - Event Log
 - Network Tests
 - Upgrade History
 - Resets
- Advanced
 - Syslog Settings
 - Provisioning Info
 - Configure Time Services
 - Configure Services
 - DNS Resolve
 - Link Manager
 - Detailed Log

Firewall – Advanced Settings

WARNING
Modifying the settings on this page can impact the ability of computers on the local network to access your broadband connection. Modifications may also affect broadband-enabled applications and services running on the local network.

Security
Check to enable the features below:

- Stealth Mode
 - Block Ping
- Strict UDP Session Control

Inbound and Outbound Control
Checking the box allows the associated traffic type through the firewall.

Outbound

- HTTP
- HTTPS
- FTP
- Telnet
- SMTP
- DNS
- NetBIOS
- POP3
- IMAP
- NNTP
- IRC
- H323
- All Other Protocols

Attack Detection

- Excessive Session Detection
- TCP/UDP Port Scan
- Invalid Source/Destination IP address
- Packet Flood (SYN/UDP/ICMP/Other)
- Invalid TCP Flag Attacks (NULL/XMAS/Other)
- Invalid ICMP Detection
- Miscellaneous

Full Logging
Enable Full Logging: **Note:** Enabling full logging will reduce system performance.

SUBMIT Settings

[Back to Top](#)

For details on configuring advanced firewall settings, refer to page 29.

Troubleshooting - DSL Diagnostics Page

The Troubleshooting - DSL Diagnostics page displays data associated with the 3700HGV-B gateway's VDSL link.



Note: Most of the values displayed on this page are calculated once at the start of the connection. Values that are dynamically updated during the connection are marked with an asterisk (*).

Analyzing General Information

The General Information pane shows diagnostic information for the current VDSL connection (or connection attempt). These values are also listed in the last row of the Training History pane.

Item	Description	Value	Comment
DSL Line	During line search, the value will alternate between 1 and 2. The “Searching for DSL signal” comment appears until the VDSL protocol is confirmed with the DSLAM on the current line.	1 or 2.	None or Searching for DSL signal.
Downstream	Atten. at 300kHz		

Item	Description	Value	Comment
Final Rx Gain	Indicates the current receive gain setting (in dB).	Dependent on DSL line length.	Ok or Suspicious - possible saturation.
Delay of latency path	The delay, in milliseconds, imposed by the modem on the interleaved frames.		

Reviewing Training History

This pane provides a record of the last 20 connection attempts. The current connection or connection attempt is displayed in the last row.

Item	Description
*Time	Initially this field will display the time (since power on) in DAYS HH:MM:SS format, until the gateway can access the Internet and retrieve the current local time. Subsequently the time (since power on) is displayed in YY:MM:DD and HH:MM:SS format.
Line	The line (1 or 2) on which the gateway is searching for a DSL signal.
Downstream	
Rate	The net user data rate (in kbps) for the connection.
Max1	Maximum rate achievable at the time of the initial connection based on the line quality (specifically, the uncapped rate).
*Max2	Latest estimate of maximum achievable rate adjusted for changing line conditions.
Mgn1	Noise margin (in dB) at the start of the connection.
*Mgn2	Latest noise margin adjusted for changing line conditions since the connection was first established.
Attn	Measured attenuation (dB) of the line.
Pwr	Transmit power (dB).
*CRCs	Total uncorrected errors for this connection.
*FECs	Total corrected errors for this connection.
Upstream	
Rate	The net user data rate (in kbps) for the connection.

Item	Description
Max	Maximum rate achievable at the time of the initial connection based on the quality of the line (specifically, the uncapped rate).
Mgn	Noise margin (in dB) at the start of the connection.
Attn	Measured attenuation (dB) of the line.
Pwr	Transmit power (dB).
*CRCs	Total uncorrected errors for this connection.
*FECs	Total corrected errors for this connection.
Mode	The DSL mode used.
Vendor	Vendor ID of the DSLAM (for example, ALCB indicates Alcatel DSLAM in G.DMT mode).
Rx Gain	Indicates the current receive gain setting, which will depend on the length of the DSL line.

Reviewing Bitloading

The Bitloading pane shows the bits loaded per tone for the upstream (tones 6 to 31) and downstream (tones 32 to 255) spectrum. A single hex-digit for each tone shows the numeric value (0 to F) in addition to the bar-graph depiction.*



Troubleshooting - Event Log Page

The Troubleshooting – Event Log page displays events for the broadband and local network. Log information is stored in a fixed-size buffer. When the buffer is full, the oldest items are purged from the log. You can also clear the log contents by clicking the **Clear Log** button.

Management and Diagnostic Console

[System Summary](#)

Broadband Link

- [• Summary](#)
- [• Statistics](#)
- [• Detailed Statistics](#)
- [• Configure](#)

Local Network

- [• Status](#)
- [• Statistics](#)
- [• Device List](#)
- [• Wireless](#)
- [• Configure](#)
- [• Address Allocation](#)
- [• MoCA](#)
- [• MoCA Statistics](#)

Firewall

- [• Settings](#)
- [• Detailed Information](#)
- [• Advanced Settings](#)

Troubleshooting

- [• DSL Diagnostics](#)
- [• Event Log](#)
- [• Network Tests](#)
- [• Upgrade History](#)
- [• Resets](#)

Advanced

- [• Syslog Settings](#)
- [• Provisioning Info](#)
- [• Configure Time Services](#)
- [• Configure Services](#)
- [• DNS Resolve](#)
- [• Link Manager](#)
- [• Detailed Log](#)

Troubleshooting – Event Log

all FILTER

CLEAR LOG

Type	Date/Time	Event Description
INF	P0000-00-00T00:00:23	sys: Wireless SSID set to 2WIRE324
INF	P0000-00-00T00:00:23	sys: Wireless authentication set to Open
INF	P0000-00-00T00:00:23	sys: Wireless encryption set to WEP
INF	P0000-00-00T00:00:23	sys: Wireless Key set
INF	P0000-00-00T00:00:23	sys: Wireless channel set to 6
INF	P0000-00-00T00:00:23	sys: Wireless power set to 100
INF	P0000-00-00T00:00:24	sys: ipnet1: Up on bridge0 with 192.168.1.254/24
INF	P0000-00-00T00:00:23	hurl: err=10 name=BB_NOT_UP detect
INF	P0000-00-00T00:00:26	hurl: err=0 name=PHY_NONE detect
INF	P0000-00-00T00:30:45	hurl: err=0 name=PHY_NONE clear
INF	P0000-00-00T00:32:45	hurl: err=0 name=PHY_NONE detect
INF	P0000-00-00T00:53:47	hurl: err=0 name=PHY_NONE redirect

CLEAR LOG

↶
Back to Top

Users can view specific information by selecting which log to view from the pull-down menu and then clicking the **Filter** button. Following are descriptions of the logs.

- **Access.** Shows the current access log, which registers all significant Content Screening and Internet Access Control events.
- **All.** Shows all logs that register a significant event (access, firewall, fw alert, system, and wra).
- **Firewall.** Shows all detailed firewall events, including Internet Access Control and Firewall Monitor.
- **FW Alert.** Shows the current Firewall Monitor log, which registers all significant Firewall Monitor-related events.
- **System.** Shows the current system log, which registers all significant events within the 2Wire gateway since it was last restarted.
- **WRA.** Shows the current Web Remote Access log, which registers all significant Web Remote Access-related events.

Each log entry includes the severity level, a description of the event, and the actual time that it occurred. The most recent events display at the *bottom* of the list.

Events generate an Informational or Warning severity level. Informational indicates events that are informational only; Warning indicates an unexpected condition that does not affect the 2Wire gateway's ability to operate (for example, a network problem or the 2Wire gateway is not configured properly).

Troubleshooting - Network Tests Page

The Troubleshooting – Network Tests page provides the Traceroute and Ping tools, which help diagnose problems with the 2Wire gateway or 2Wire gateway connections.

The screenshot shows the 2Wire Management and Diagnostic Console interface. On the left is a navigation menu with categories: System Summary, Broadband Link, Local Network, Firewall, Troubleshooting, and Advanced. The main content area is titled "Troubleshooting – Network Tests". It features a dropdown menu set to "ping", a checkbox for "Enable network name resolution", and input fields for "Host", "Test" (set to 30), and "Packet Size" (set to 64). Below these are "START" and "STOP" buttons and a large empty rectangular area for test results.

The Ping test allows you to ensure that the 2Wire gateway can send data packets to (ping) a remote host or a local LAN device (such as a PC). The Traceroute test traces the number of times a data packet sent from the 2Wire gateway is routed before it reaches its destination.

Troubleshooting - Upgrade History Page

The Upgrade History page shows a log of all system software upgrades, and lists the upgrades in the order in which they occurred.



<p>System Summary</p> <p>Broadband Link</p> <ul style="list-style-type: none"> Summary Statistics Detailed Statistics Configure <p>Local Network</p> <ul style="list-style-type: none"> Status Statistics Device List Wireless Configure Address Allocation MoCA MoCA Statistics <p>Firewall</p> <ul style="list-style-type: none"> Settings Detailed Information Advanced Settings <p>Troubleshooting</p> <ul style="list-style-type: none"> DSL Diagnostics Event Log Network Tests Upgrade History Resets <p>Advanced</p> <ul style="list-style-type: none"> Syslog Settings Provisioning Info Configure Time Services Configure Services DNS Resolve Link Manager Detailed Log 	<h3>Troubleshooting – Upgrade History</h3> <p>Current Version</p> <table> <tr> <td>Model Number:</td> <td>3700HGV-B Gateway</td> </tr> <tr> <td>Hardware Version:</td> <td>2700-000499-001</td> </tr> <tr> <td>Software Version:</td> <td>4.23.17</td> </tr> </table> <hr/> <p>Upgrade Log</p> <table> <tr> <td>Initial Software Version:</td> <td>4.23.17</td> </tr> </table>	Model Number:	3700HGV-B Gateway	Hardware Version:	2700-000499-001	Software Version:	4.23.17	Initial Software Version:	4.23.17
Model Number:	3700HGV-B Gateway								
Hardware Version:	2700-000499-001								
Software Version:	4.23.17								
Initial Software Version:	4.23.17								



Troubleshooting Resets Page

The Troubleshooting – Resets page allows you to reset various components associated with the 2Wire gateway network.



System Summary

Broadband Link

- [Summary](#)
- [Statistics](#)
- [Detailed Statistics](#)
- [Configure](#)

Local Network

- [Status](#)
- [Statistics](#)
- [Device List](#)
- [Wireless](#)
- [Configure](#)
- [Address Allocation](#)
- [MoCA](#)
- [MoCA Statistics](#)

Firewall

- [Settings](#)
- [Detailed Information](#)
- [Advanced Settings](#)

Troubleshooting

- [DSL Diagnostics](#)
- [Event Log](#)
- [Network Tests](#)
- [Upgrade History](#)
- [Resets](#)

Advanced

- [Syslog Settings](#)
- [Provisioning Info](#)
- [Configure Time Services](#)
- [Configure Services](#)
- [DNS Resolve](#)
- [Link Manager](#)
- [Detailed Log](#)

Troubleshooting – Resets

- CLEAR** **Local Network** Clears all devices from your Local Network list. Network devices will appear in the list as they are re-discovered.
- RESET** **DSL Connection** Retrains your DSL connection on the same line.
- RESET** **IP Connection** Resets connections and/or releases and renews your broadband IP address.
- RESET** **Broadband Link** Reestablishes your broadband link.
- RESET** **3700HGV-B Gateway** Reboots your 3700HGV-B Gateway.
- RESET** **to Factory State** Warning! Resets configuration parameters.

Note: These actions are for diagnostic and troubleshooting purposes only. Some actions will change configuration settings and will affect the operation of your gateway.

Advanced - Syslog Settings Page

The Advanced - Syslog Settings page allows users to maintain a history of events greater than the capacity of the 2Wire gateway by enabling a syslog server. Use of this feature requires a computer running a syslog daemon.

2WIRE Management and Diagnostic Console

[System Summary](#)

Broadband Link

- [Summary](#)
- [Statistics](#)
- [Detailed Statistics](#)
- [Configure](#)

Local Network

- [Status](#)
- [Statistics](#)
- [Device List](#)
- [Wireless](#)
- [Configure](#)
- [Address Allocation](#)
- [MoCA](#)
- [MoCA Statistics](#)

Firewall

- [Settings](#)
- [Detailed Information](#)
- [Advanced Settings](#)

Troubleshooting

- [DSL Diagnostics](#)
- [Event Log](#)
- [Network Tests](#)
- [Upgrade History](#)
- [Resets](#)

Advanced

- [Syslog Settings](#)
- [Provisioning Info](#)
- [Configure Time Services](#)
- [Configure Services](#)
- [DNS Resolve](#)
- [Link Manager](#)
- [Detailed Log](#)

Advanced – Syslog Settings

Enable Syslog:

Server Location:

Server Port: (Optional. Default = 514)

Enable Throttling:

Limit Logging to: logs per second

Settings

Advanced - Provisioning Info Page

The Advanced – Provisioning Info page displays the parameters with which the 2Wire gateway was provisioned.

Management and Diagnostic Console

System Summary

- Overview
- Statistics
- General Statistics
- Config
- Local Network
- Status
- Statistics
- General Log
- Messages
- Config
- Software Updates
- Tools
- Macs Statistics
- Firewall
- Status
- General Statistics
- Advanced Settings
- Troubleshooting
- DNS Statistics
- Config Log
- Network Tools
- System
- Advanced
- Status Settings
- Troubleshooting
- Configuration Services
- Configuration Services
- DNS Settings
- Log Manager
- Connect Log

Advanced – Provisioning Information

Module Configuration

```

router0 modid: 0 parentid: 0 flags: 0 run level: 6 > 10
LED profile
1

global0 modid: 1 parentid: 0 flags: 0 run level: 6 > 10

home0 modid: 2 parentid: 0 flags: 0 run level: 6 > 10

lband0 modid: 3 parentid: 0 flags: 0 run level: 6 > 10
lbandice
lbandtype
0

device0 modid: 4 parentid: 1 flags: 0 run level: 6 > 10

rmod0 modid: 5 parentid: 1 flags: 0 run level: 6 > 10

rmod0 modid: 5 parentid: 1 flags: 0 run level: 6 > 10

red0 modid: 7 parentid: 1 flags: 0 run level: 6 > 10

dial0 modid: 8 parentid: 3 flags: 0 run level: 6 > 10
DSL Line #1
0

dhw0 modid: 15 parentid: 30 flags: 0 run level: 6 > 10

bridge0 modid: 10 parentid: 2 flags: 0 run level: 6 > 10
bridgeip
0
device0
eth0
device0d0
-1
device1
usb0
device0d1
-1
device2
rsync0
device0d2
-1
device3
wire0
device0d3
-1
devicecount
5
device4
moca0
device0d4
-1
mac0d5
home
H.Alwaysup
1

bridge1 modid: 17 parentid: 8 flags: 0 run level: 6 > 10
devicecount
1
device0
eth0
device0d0
-1
mac0d5
stand

bridge2 modid: 18 parentid: 3 flags: 0 run level: 6 > 10
H.Alwaysup
1

bridge3 modid: 19 parentid: 2 flags: 0 run level: 6 > 10
bridgeip
4
devicecount
1
device0
rsync0
device0d0
-1
etpcount
1
etp0
2480
mac0d5
home
H.Alwaysup
1

bridge0mod0 modid: 20 parentid: 22 flags: 0 run level: 6 > 10

```

UI Param Configuration

```

SHOW_CSPEED TRUE
SHOW_SLEEPY_MODES TRUE
SHOW_REMOTE_PWD_RESET TRUE
WPA_SHOW_LOGOUT TRUE
SHOW_BLOCK_HIDE TRUE
SHOW_WL_STATUS TRUE
HAVE_BBA_MAC OFF
HAVE_BBA_VOICE OFF
HAVE_BBA_CS OFF
HAVE_BBA_WEP/WEP OFF
HAVE_BBA_WPA/WPA OFF
HAVE_BBA_WPA/WPA OFF
HAVE_BBA_WPA/WPA OFF
HAVE_BBA_WPA/WPA OFF
HAVE_BBA_WPA/WPA OFF
SERVICE_FW TRUE
SERVICE_NOR TRUE

```

Server Set Configuration

```

enable_nearbeat 1
nearbeat_base 0
nearbeat_period 60400
enable_rpc_listen 0
rpc_listen_port 2478
rpc_url http://comp:01-stcglobal.net/comp/services/COMP
chp_url csa:1033.oma.2wire.com:3428
pkgsel_active 0
boot_checksum 0

```

Firewall Configuration

```

allowed KILL_HTTP,KILL_HTTPS,KILL_FTP,KILL_TELNET,
KILL_SFTP,KILL_DNS,KILL_POP3,KILL_MMAP,
KILL_SSH,KILL_RDP,KILL_H323,KILL_NETBIOS,
KILL_OTHER

outbound KILL_NETBIOS
params etp0,usb =OFF
icsa_log =OFF
port_scan =ON
snatch_check =ON
topapps_check =ON
xmpcodecheck =ON
misc_check =ON
top_app_time =60400
usb_ch_time =600
pscan_period =1000
pscan_block_refresh =3
pscan_dns_refresh =18
pscan_dns_ipset_refresh =100
fresh_sess_per_host =400
min_session_top_time =10
host_ip_threshold =300
host_ip_refresh =300
host_ip_refresh =300
flow_detect =OFF
snatch =ON
block_ping =ON
snatch_def =ON
block_ping_def =ON
flow_detect_def =OFF

```

59

Advanced - Configure Time Services Page

The Advanced – Configure Time Services page allows you to view and change system time and date settings.

2WIRE Management and Diagnostic Console

Advanced – Configure Time Services SUBMIT Settings

Current Time Settings

Date: Thursday, April 4, 2002
 Time: 04:15:02 AM
 Time Zone: Pacific Standard Time
 Time Configuration: Automatic

Manually Set Time/Date

Enable:

Time: [] : [] : [] (hh : mm : ss)
 Date: [] / [] / [] (yyyy / mm / dd)
 Time Zone: (GMT-08:00) Pacific Time (US & Canada); Tijuana
 Daylight Savings Time: Automatically adjust

Configure Internet Time Servers

Time Servers:	ntp1.2wire.com
	ntp2.2wire.com
	ntp3.2wire.com
	ntp4.2wire.com
	ntp.ucsd.edu

As part of the 2Wire gateway setup process, users specify the time zone in which they are located so that the time and date are automatically displayed in the 2Wire gateway user interface. These time settings are displayed in the Current Time Settings panel, which shows the current date, time, time zone, and whether the time was automatically or manually configured. If users wish to manually set the time and date, they can do so in the Manually Set Time/Date panel.

Advanced - Configure Services Page

The Advanced – Configure Services page allows users to change the timeout settings for NAT, enable broadband status notification, enable the SIP ALG, and change the upstream maximum transmission rate.

EWIC Management and Diagnostic Console

Advanced – Configure Services SUBMIT Settings

NAT
TCP Timeout: Minutes (5 – 1440 minutes, default = 1440 minutes)
UDP Timeout: Minutes (1 – 720 minutes, default = 10 minutes)

Broadband Status Notification
Enable:

SIP Application Layer Gateway
Enable:

Upstream MTU
Force Upstream MTU: SUBMIT Settings

[Back to Top](#)

System Summary
Broadband Link
• [Summary](#)
• [Statistics](#)
• [Detailed Statistics](#)
• [Configure](#)
Local Network
• [Status](#)
• [Statistics](#)
• [Device List](#)
• [Wireless](#)
• [Configure](#)
• [Address Allocation](#)
• [MoCA](#)
• [MoCA Statistics](#)
Firewall
• [Settings](#)
• [Detailed Information](#)
• [Advanced Settings](#)
Troubleshooting
• [DSL Diagnostics](#)
• [Event Log](#)
• [Network Tests](#)
• [Upgrade History](#)
• [Resets](#)
Advanced
• [Syslog Settings](#)
• [Provisioning Info](#)
• [Configure Time Services](#)
• [Configure Services](#)
• [DNS Resolve](#)
• [Link Manager](#)
• [Detailed Log](#)

Advanced - DNS Resolve Page

The Advanced - DNS Resolve page allows users to name network devices (such as printers or web servers) so that they can be easily accessed by other users on the network.

The screenshot shows the ZWIRE Management and Diagnostic Console interface. On the left is a navigation menu with categories: System Summary, Broadband Link, Local Network, Firewall, Troubleshooting, and Advanced. The main content area is titled "Advanced - DNS Name table" and includes a form to "Define a Name and Address to resolve" with fields for "DNS name:" and "IP Address:" and an "ADD" button. Below the form is a table with columns "DNS name", "IP Address", and "Entry Type".

ZWIRE Management and Diagnostic Console

System Summary

- [Summary](#)
- [Statistics](#)
- [Detailed Statistics](#)
- [Configure](#)

Broadband Link

- [Status](#)
- [Statistics](#)
- [Device List](#)
- [Wireless](#)
- [Configure](#)
- [Address Allocation](#)
- [MoCA](#)
- [MoCA Statistics](#)

Local Network

- [Status](#)
- [Statistics](#)
- [Device List](#)
- [Wireless](#)
- [Configure](#)
- [Address Allocation](#)
- [MoCA](#)
- [MoCA Statistics](#)

Firewall

- [Settings](#)
- [Detailed Information](#)
- [Advanced Settings](#)

Troubleshooting

- [DSL Diagnostics](#)
- [Event Log](#)
- [Network Tests](#)
- [Upgrade History](#)
- [Resets](#)

Advanced

- [Syslog Settings](#)
- [Provisioning Info](#)
- [Configure Time Services](#)
- [Configure Services](#)
- [DNS Resolve](#)
- [Link Manager](#)
- [Detailed Log](#)

Advanced - DNS Name table

Define a Name and Address to resolve

DNS name:

IP Address:

Name table

DNS name	IP Address	Entry Type
----------	------------	------------

Advanced - Link Manager States Page

The Advanced – Link Manager States page is a tree representation of the 2Wire gateway interface stack, and shows the internal state of the 2Wire gateway.

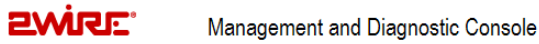

[System Summary](#)

Broadband Link

- [Summary](#)
- [Statistics](#)
- [Detailed Statistics](#)
- [Configure](#)

Local Network

- [Status](#)
- [Statistics](#)
- [Device List](#)
- [Wireless](#)
- [Configure](#)
- [Address Allocation](#)
- [MoCA](#)
- [MoCA Statistics](#)

Firewall

- [Settings](#)
- [Detailed Information](#)
- [Advanced Settings](#)

Troubleshooting

- [DSL Diagnostics](#)
- [Event Log](#)
- [Network Tests](#)
- [Upgrade History](#)
- [Resets](#)

Advanced

- [Syslog Settings](#)
- [Provisioning Info](#)
- [Configure Time Services](#)
- [Configure Services](#)
- [DNS Resolve](#)
- [Link Manager](#)
- [Detailed Log](#)

Advanced – Link Manager States

```

↳root0 is UP
  ↳global0 is UP
    ↳device0 is UP
    ↳mnet0 is UP
    ↳route0 is UP
    ↳fw0 is UP
    ↳cms0 is MGMT_SEARCH
  ↳home0 is UP
    ↳bridge0 is UP
      ↳ipnet1 is UP
        ↳bridgemon0 is UP
        ↳ipbridge0 is UNCONFIGED
      ↳bridge3 is PHY_NONE
    ↳bband0 is UP
      ↳dsl0 is PHY_NONE
        ↳bridge1 is
          ↳eap00 is
            ↳dhcp0 is
              ↳jnet0 is
                ↳dnstest0 is
↳bridge2 is NOT_PROV
          
```

The Link Manager States page is used to gather dynamic information on internal networking modules, and is based on the runtime configuration of the 2Wire gateway. The information cannot be used to configure the 2Wire gateway.

To view information about each node, click the node link. Information displays below the Link Manager States tree, and includes the following:

Node information	Description
Link status	Up. The link is functioning properly. Climbing. The link is attempting to establish a connection. Down. The link is not yet configured. Error. An error has occurred.
State changes	The number of times the state of the link has changed (since last reboot).

Advanced - Detailed Log Page

The Advanced – Detailed Log page is a debug log facility modeled after syslog, and provides advanced diagnostic capabilities.

Management and Diagnostic Console

[System Summary](#)

Broadband Link

- [• Summary](#)
- [• Statistics](#)
- [• Detailed Statistics](#)
- [• Configure](#)

Local Network

- [• Status](#)
- [• Statistics](#)
- [• Device List](#)
- [• Wireless](#)
- [• Configure](#)
- [• Address Allocation](#)
- [• MoCA](#)
- [• MoCA Statistics](#)

Firewall

- [• Settings](#)
- [• Detailed Information](#)
- [• Advanced Settings](#)

Troubleshooting

- [• DSL Diagnostics](#)
- [• Event Log](#)
- [• Network Tests](#)
- [• Upgrade History](#)
- [• Resets](#)

Advanced

- [• Syslog Settings](#)
- [• Provisioning Info](#)
- [• Configure Time Services](#)
- [• Configure Services](#)
- [• DNS Resolve](#)
- [• Link Manager](#)
- [• Detailed Log](#)

Advanced – Detailed Log

CLEAR LOG
INSERT MARK

DBG or higher (All) FILTER

```

INF P0000-00-00T00:02:33 cvd: CVD: stop_dsl: got called
INF P0000-00-00T00:02:33 cvd: CVD: start_dsl: got called
INF P0000-00-00T00:02:33 cvd: Switching to line 1
INF P0000-00-00T00:02:34 cvd: CVD: network link is down
INF P0000-00-00T00:02:39 ulib: Node 1 Added mac:00:0d:56:dd:e4:9f
INF P0000-00-00T00:03:04 cvd: CVD: stop_dsl: got called
INF P0000-00-00T00:03:05 cvd: CVD: start_dsl: got called
INF P0000-00-00T00:03:05 cvd: Switching to line 3
INF P0000-00-00T00:03:06 cvd: CVD: network link is down
INF P0000-00-00T00:04:02 cvd: CVD: stop_dsl: got called
INF P0000-00-00T00:04:02 cvd: CVD: start_dsl: got called
INF P0000-00-00T00:04:02 cvd: Switching to line 1
INF P0000-00-00T00:04:03 cvd: CVD: network link is down
INF P0000-00-00T00:04:33 cvd: CVD: stop_dsl: got called
INF P0000-00-00T00:04:34 cvd: CVD: start_dsl: got called
INF P0000-00-00T00:04:34 cvd: Switching to line 3
INF P0000-00-00T00:04:35 cvd: CVD: network link is down
INF P0000-00-00T00:05:05 cvd: CVD: stop_dsl: got called
INF P0000-00-00T00:05:05 cvd: CVD: start_dsl: got called
INF P0000-00-00T00:05:05 cvd: Switching to line 1
INF P0000-00-00T00:05:06 cvd: CVD: network link is down
INF P0000-00-00T00:06:05 cvd: CVD: stop_dsl: got called
INF P0000-00-00T00:06:06 cvd: CVD: start_dsl: got called
INF P0000-00-00T00:06:06 cvd: Switching to line 3
INF P0000-00-00T00:06:07 cvd: CVD: network link is down
INF P0000-00-00T00:06:37 cvd: CVD: stop_dsl: got called
INF P0000-00-00T00:06:37 cvd: CVD: start_dsl: got called
INF P0000-00-00T00:06:37 cvd: Switching to line 1
INF P0000-00-00T00:06:38 cvd: CVD: network link is down
INF P0000-00-00T00:07:09 cvd: CVD: stop_dsl: got called
INF P0000-00-00T00:07:09 cvd: CVD: start_dsl: got called
INF P0000-00-00T00:07:09 cvd: Switching to line 3
INF P0000-00-00T00:07:10 cvd: CVD: network link is down
INF P0000-00-00T00:07:40 cvd: CVD: stop_dsl: got called
INF P0000-00-00T00:07:40 cvd: CVD: start_dsl: got called
INF P0000-00-00T00:07:40 cvd: Switching to line 1
INF P0000-00-00T00:07:41 cvd: CVD: network link is down
INF P0000-00-00T00:08:17 cvd: CVD: stop_dsl: got called
INF P0000-00-00T00:08:17 cvd: CVD: start_dsl: got called
INF P0000-00-00T00:08:17 cvd: Switching to line 3
INF P0000-00-00T00:08:18 cvd: CVD: network link is down
INF P0000-00-00T00:08:48 cvd: CVD: stop_dsl: got called
                    
```

Next
INSERT MARK

Back to Top

Upgrade the Software

Gateway field upgrades are typically performed via CMS, which is the gateway remote management system. The following procedure describes how to perform a local upgrade; however, because the gateway's configuration information is not retained when performing a local upgrade, upgrading via CMS is the preferred method. Perform the local upgrade *only* if you cannot access the broadband link to upgrade via CMS, or the target release is not published on CMS.



Note: This procedure assumes that you have been provided with a software image via CD, or downloaded it from an ftp server.



Note: Do *not* disconnect the power cord from the gateway during an upgrade. Doing so will erase all gateway information, and cause the gateway to fail.

1. Open a browser and enter <http://home/upgrade>. The following page opens.



Manually Upgrade the System

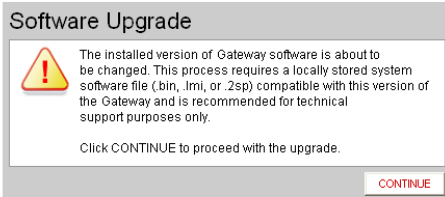

2. Click **CONTINUE**. In the provided field, enter the location of the software image or click the **Browse** button and navigate to the location where the image is stored. Click **UPGRADE NOW**.



Upgrade the System

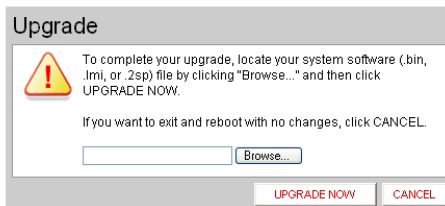

3. The gateway firmware is upgraded. The gateway will then reboot.

4. After the gateway reboots, the Conexant firmware is upgraded.



Configuring Multiple Static IP Addresses

This chapter describes how to configure the 3700HGV-B for use with multiple service provider-assigned (static) broadband IP addresses on the SBC Lightspeed network.

To use multiple broadband addresses with the 3700HGV-B, you must have subscribed to the appropriate service from your Internet Service Provider. In addition, you need the IP address and networking information that has been identified for the subscribed service.

The configuration process is divided into three steps.

- 1.** Enable the Public Network function of the 3700HGV-B and configure it with the appropriate router IP address and subnet mask.
- 2.** Assign the broadband IP address(es) to the desired network devices.
- 3.** (Optional) Configure firewall rules to direct unsolicited traffic to the associated network devices.

Step 1: Enable Public Network Mode

To enable Public Network mode:

1. Access the Management and Diagnostic Console (MDC) by entering <http://gateway.2wire.net/management> in your browser's address bar.
2. In the left-hand navigation menu, click the Local Network - Configure link. The Local Network - Configuration page opens.

The screenshot shows the 2Wire Management and Diagnostic Console interface. The main heading is "Local Network - Configuration". On the left is a navigation menu with categories like Broadband Link, Local Network, Firewall, Troubleshooting, and Advanced. The main content area includes a "WARNING" box, a "Private Network" section with radio buttons for different IP ranges (192.168.1.0, 172.16.0.0, 10.0.0.0), and a "Configure manually" section with input fields for Router Address, Subnet Mask, First DHCP Address, and Last DHCP Address. There is also a "Set DHCP Lease Time" field set to 24 hours. Below that are "Display Settings" with a checked box for "Show inactive devices in network list" and "Enable Router behind Router alert" with a checked box for "Display alert when another router is connected to this router." At the bottom right, there are "SUBMIT" and "Settings" buttons, and a "Back to Top" link.

3. In the Public Network pane, click the **Create a route from the Internet to the public network specified below** checkbox. Alternatively, you can use the Home Network - Advanced Settings page to set this information.

Your gateway uses two sets of IP addresses, one for use between the router and the network (usually just 2 addresses) and a second independent set solely for use with end devices. You should have been provided with the second set of IP addresses. For example, you might have been provided with a WAN gateway address of 66.124.231.65 and a WAN IP address for your router of 66.124.231.66, and told that your LAN devices were to use addresses in the range 207.214.87.137 through 207.214.87.141.

4. In the Router Address and Subnet Mask fields, enter the router address and subnet mask provided to you by your ISP
5. Click the **Submit** button to save your results.

If you did not receive a subnet mask from your ISP, but were provided with a number of addresses has been, you can look up the associated subnet mask in the table below. Because this information may have been identified in a number of different ways, it has been presented here in a number of different ways.

Total Address Used by the Subnet	CIDR	Number of Useable Addresses	Address Required for DSL Router	Addresses Available for LAN Devices	Subnet Mask to Use
8	/29	6	1	5	255.255.255.248
16	/28	14	1	13	255.255.255.240
32	/27	30	1	29	255.255.255.224
64	/26	62	1	61	255.255.255.192
128	/25	126	1	125	255.255.255.128
256	/24	254	1	253	255.255.255.0

Step 2: Allocate Public IP Addresses to the LAN Clients

This step requires that all network devices that you wish to configure with a broadband IP address be turned on and connected to the 3700HGV-B. Devices should be configured to use their DHCP client for obtaining an IP address, although this is not an absolute requirement as identified below.

Once the gateway is configured to use multiple broadband IP addresses, network devices can be configured for one of three modes. Access the Address Allocation page of the MDC to select the desired option (Figure 2) for each LAN device. This information can also be set by clicking the **EDIT ADDRESS ALLOCATION** button on the Home Network - Advanced Settings page.

- **Mode 1: DHCP Private Network.** The network client is given a private IP address on the private network (Default is the 192.168.1.0 network). This is the normal mode of operation for all LAN devices by default (with or without the use of multiple broadband addresses.)
- **Mode 2: Public Fixed Network.** The network client is given one of the currently available broadband IP addresses. The address may change as the IP address lease is renewed, but will always come from the pool of available broadband IP addresses.
- **Mode 3: DHCP Fixed Address.** The network client is permanently assigned one of the broadband IP addresses. The address will not change until the gateway is reconfigured via the Address Allocation page. This will be the most common configuration for publicly accessible network devices.

In all the above cases, the network devices should be configured to enable their DHCP client. From this point on, the IP addresses for these LAN devices are managed by the 3700HGV-B. However, if DHCP is unavailable or its use undesirable, devices can be configured (hard-coded) with a static IP address.

For devices in the Private Network (NAT), the proper range must be used. The default range is 192.168.1.0, so the network device may statically use 192.168.1.1 through 192.168.1.64, inclusive. Devices assigned with these addresses act as if they were assigned an IP address (Mode 1 above).

For devices using the Public Network addresses, simply configure the device to use the IP address (subnet mask and default gateway) as assigned by the ISP. The gateway will automatically detect the usage of a broadband IP address on the LAN network and correctly route the return traffic to the appropriate LAN device. Once a broadband IP address has been detected by the gateway as being statically coded on the device, its entry in the Address Allocation page will no longer be displayed.



Note: The ability to use DHCP in assigning WAN addresses to LAN devices is different from how some other routers operate. These other routers usually require that the address be hard coded on the LAN device.

Upon successful configuration of the gateway, refresh the IP address of the network device (this may require restarting that device). It should now have the desired public, or private, IP address assigned by the 3700HGV-B. Confirm proper configuration by attempting to access the public Internet.

Figure 2

Step 3: Configure Firewall Rules

LAN devices using addresses from the Public Network are still protected by the gateway firewall. To allow unsolicited inbound traffic to any of these LAN devices, you must modify the firewall settings specified for that device. That is, a LAN device can receive inbound traffic associated with outbound traffic (e.g., web browsing) but needs to have a firewall rule established to function as a server.

To change the firewall settings, access the Firewall - Settings page of the MDC or the Firewall Settings page of the standard web pages to configure the Hosted applications allowed for each device to be used with unsolicited traffic.



Note: This is different from how some other routers operate. These other routers automatically allow all traffic to pass through from the WAN to the LAN devices configured with WAN IP addresses.

The type of traffic to be received by the device determines the type of firewall configuration required:

- If the device only requires the public IP address then no rules need to be established.
- In some cases, all broadband traffic destined for a device is to be passed to that device. In this case, the 3700HGV-B should be configured to **Allow all applications** for the specific device.
- In other cases, only the traffic associated with a specific application (e.g., ftp server) is to be passed to a device. In this case, the “hosted application” feature of the 3700HGV-B will be used to configure which traffic to send to the device.



Note: The 2Wire firewall only allows traffic for a public network IP address to be directed to a local LAN device with the same public network IP address. That is, except for traffic sent to the single broadband IP address assigned to the router and shared through NAPT, traffic sent to other specific broadband IP addresses associated with the connection cannot be directed to local LAN devices that may be using private IP addresses.

Sample Configuration

In the sample network below, the customer has subscribed to service with an 8 IP address subnet (i.e., 5 usable broadband IP addresses). The customer wants to host dedicated VPN and web servers in addition to having PCs with private IP addresses. The subnet assigned to the customer is 208.35.230.192/29. The sample network is shown in Figure *.

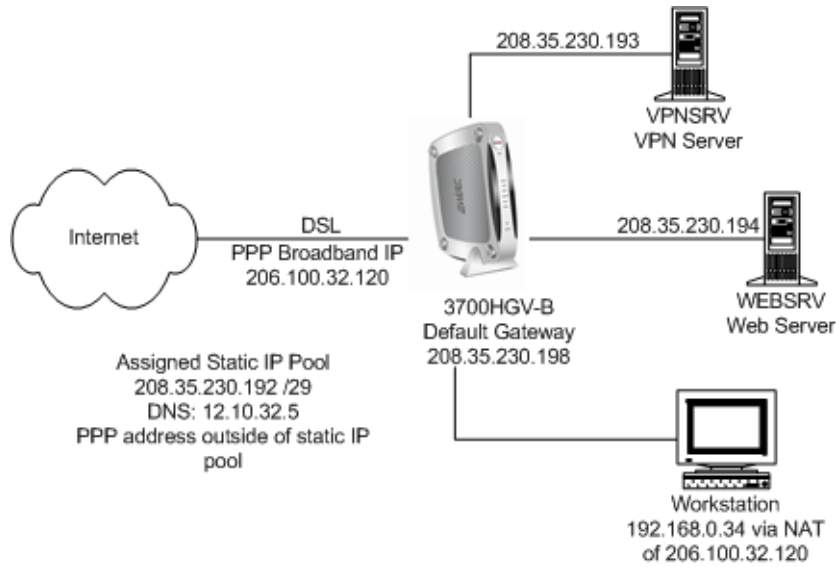

Figure *. Sample Network

Following are the steps required to configure the gateway for this configuration.

First, configure the gateway to support “Public Network” static IP addressing using the service provider assigned IP addresses of 208.35.206.198 for the gateway and a subnet mask of 255.255.255.248 as shown in Figure xxx. Click **SAVE** to ensure the changes are saved.

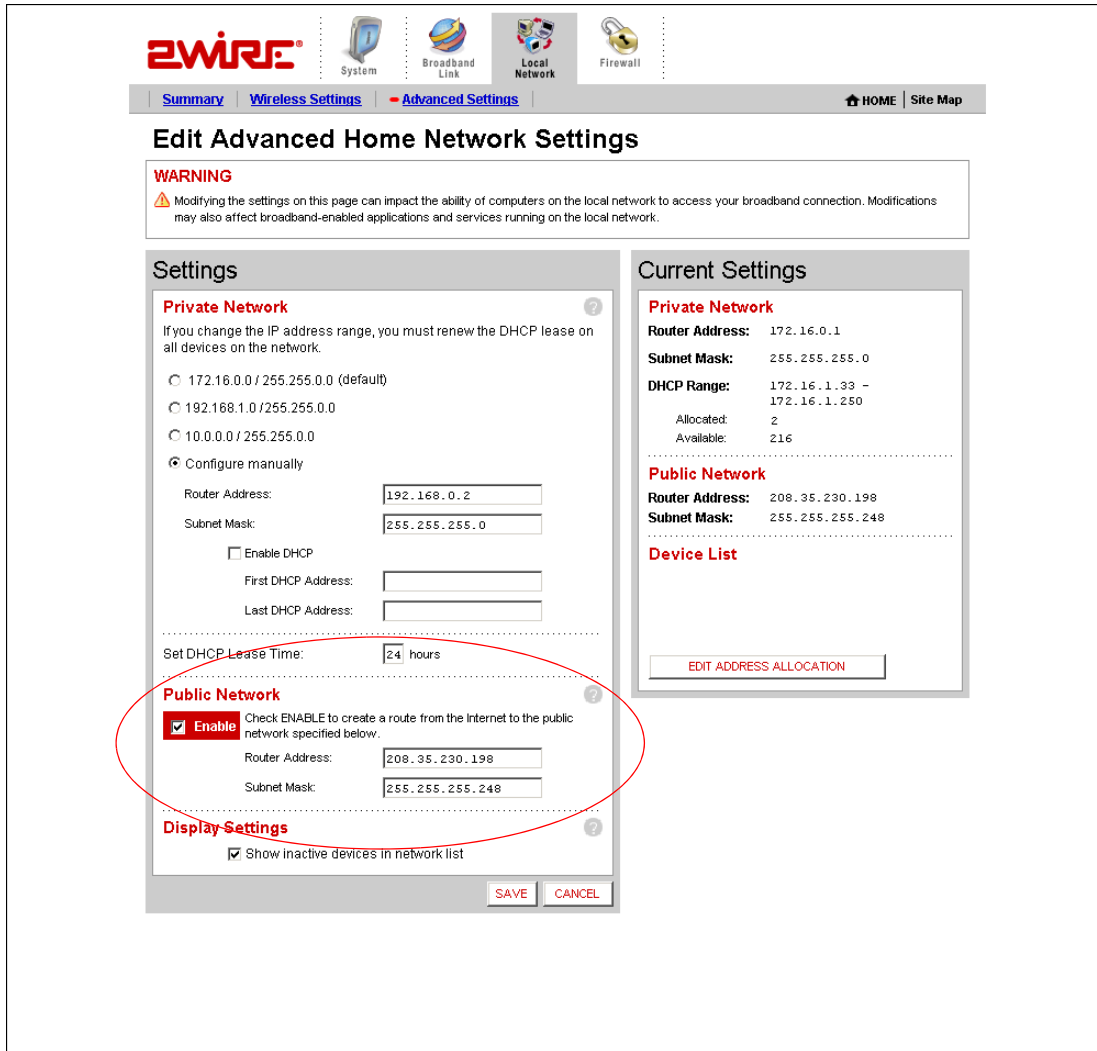

Figure xx

Second, assign static IP addresses to the Network Servers from the available. This can be done by hard coding these on the network interface for these servers or via the gateway using DHCP. The later is shown in this example.

Check that the gateway-connected network interface for each server is configured as a DHCP client (i.e. to “Obtain an IP address automatically”).

Edit the addresses assigned to each device as shown below. Assign an available static IP address to each server, selecting the “DHCP Fixed” option from the list box next to each server name. For this example, select the following options:

Device	IP Address
VPNSRV	DHCP Fixed 208.35.230.193
WEBSRV	DHCP Fixed 208.35.230.194

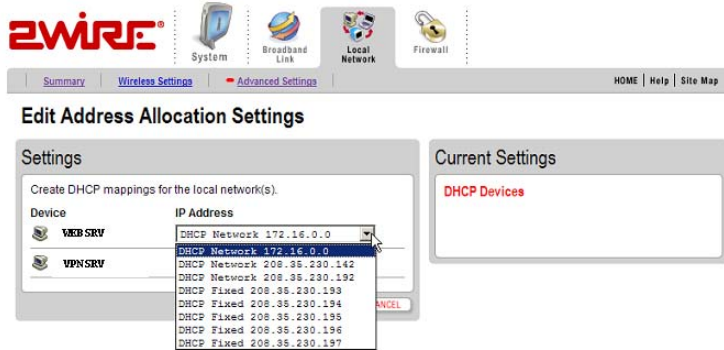

Click **SAVE** after making your selections in order to ensure the addresses are properly assigned.

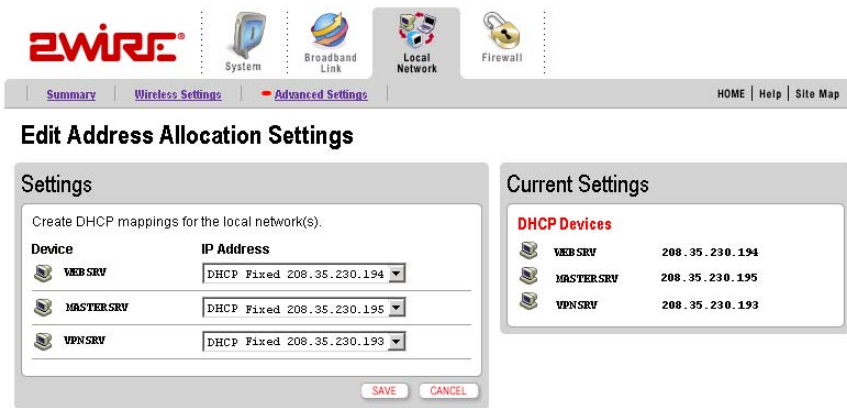

After this step, restart each server so that it is issued the desired static IP address.

Finally, configure the gateway to allow the appropriate broadband traffic to flow to the network servers.

In this example, all broadband traffic destined for the VPN server will be allowed. Allowing all inbound traffic disables the inbound port blocking feature of the gateway firewall. However, stateful packet inspection will still occur as the traffic passes through the gateway providing continued protection against Denial of Service and other common Internet attacks.

In the case of the Web Server, the “hosted application” feature of the 3700HGV-B will be used. This feature provides a quick and easy way to allow specific types of unsolicited traffic through the 3700HGV-B firewall. For the web server, this includes traffic on TCP port 80 (http).

Select the computer to which you would like to have all data sent. In this example, the computer selected is VPNSRV.

Select **Allow all applications** and click **DONE**. Doing so will allow all inbound data destined for the selected server to pass through the firewall.

To allow all traffic for the web server, configure the gateway to allow the specific type of the associated inbound ports to flow to the server. In this example, the computer WEBSRV is selected as the destination for the web server traffic.

Select the **Allow individual application(s)** option.

Select the appropriate application from the application list, click the **ADD** button, and then click the **DONE** button. In this example, the application type is “Web Server.”

When the configuration has been completed, you should confirm your firewall settings on the gateway.

LEDs

LED overview

The 2Wire Gateway has numerous indicator lights that can be used to diagnose installation and connection problems. The following table describes how to interpret the indicator lights.

Power LED	
Solid green	The gateway is powered on.
Off	The gateway is not receiving power.
Flashing red	Power-On Self-Test (POST) is in progress.
Solid red	POST failure (not bootable), or a gateway malfunction occurred.
Local Ethernet, Wireless, USB - PC, or MoCA LEDs	
Solid green	The device has established a link.
Off	The device is not connected.
Broadband LED	
Solid green	Broadband connection established via DSL or Ethernet.
Off	No physical signal detected.
Flashing green	Attempting broadband connection.
Flashing red	No broadband signal (Ethernet or DSL) detected on line.
Flashing green and red	The gateway has been unable to establish a broadband connection for more than three consecutive minutes.



Service LED

Solid green	IP connected (The residential gateway has a WAN IP address from IPCP or DHCP and the broadband connection is up, or a static IP address is configured, PPP negotiation has successfully completed - if used - and the broadband connection is up).
Off	The gateway is not receiving power. The gateway is in bridged mode. Broadband connection is not established.
Flashing green	Attempting to connect via PPP Attempting to establish IEEE 802.1X authentication. Attempting to obtain DHCP information (for non-PPP connections).
Solid red	The gateway could not establish an IP connection (for example, no DHCP response, no PPPoE response, PPPoE authentication failed, no IP address from IPCP).



Glossary

ATA (Analog Telephone Adapter). IP device (often Ethernet) with one or more ports for connecting analog telephones.

Balun. A circuit that allows signals to flow smoothly between Twisted Pair and Coax (term derived from BALanced / UNbalanced transmission medium).

Coax Splitter. Used to divide RF signals over Coax allowing more devices to be connected.

Diplexer. A bi-directional frequency specific splitter that will aid in VDSL and Video (MoCA, RF) delivery over the same Coax wiring; two different types will be used for Splitters and RG locations.

DSL Splitter. Used to separate the VDSL signals from the TDM voice service installed in the NID.

Jumpers. Short cables that connects outlets to CPE, CPE to CPE, or CPE to devices.

SIP (Session Initiated Protocol). VoIP signaling method used to set up and complete VoIP calls.

Regulatory Information

Declaration of Conformity

Trade Name: 2Wire
Responsible Party: 2Wire, Inc.
Address: 1704 Automation Parkway
San Jose, CA 95131
Phone: 408-856-1600

This device complies with Part 15 of the FCC rules. Operation is subject to the following two conditions: (1) This device may not cause harmful interference, and (2) this device must accept any interference received, including interference that may cause undesired operation.

This equipment has been tested and found to comply with the limits for a Class B digital device, pursuant to Part 15 of the Rules. These limits are designed to provide reasonable protection against harmful interference in a residential installation. This equipment generates, uses, and can radiate radio frequency energy and, if not installed and used in accordance with the instructions, may cause harmful interference to radio communications. However, there is no guarantee that interference will not occur in a particular installation. If this equipment does cause harmful interference to radio or television reception, which can be determined by turning the equipment off and on, the user is encouraged to try to correct the interference by one or more of the following measures:

- Reorient or relocate the receiving antenna.
- Increase the separation between the equipment and the receiver.
- Connect the equipment into an outlet on a circuit different from that to which the receiver is connected.
- Consult the dealer or an experienced radio/TV technician for help.

You are cautioned that any changes or modifications not expressly approved in this manual could void your authority to operate this equipment.

Only peripherals (computer input/output devices, terminals, printers, and so forth) that comply with FCC Class B limits may be attached to this computer product.

Operation with noncompliant peripherals is likely to result in interference to radio and television reception.

All cables used to connect peripherals must be shielded and grounded. Operation with cables, connected to peripherals that are not shielded and grounded may result in interference to radio and television reception.

WARNING: While this device is in operation, a separation distance of at least 20 cm (8 inches) must be maintained between the radiating antenna inside the ERU and the bodies of all persons exposed to the transmitter in order to meet the FCC RF exposure guidelines. Making changes to the antenna or the device is not permitted. Doing so may result in the installed system exceeding RF exposure requirements. This device must not be co-located or operated in conjunction with any other antenna or radio transmitter. Installers and end users must follow the installation instructions provided in this guide.

FCC Part 68

This equipment complies with Part 68 of the FCC rules. On the bottom of this equipment is a label that contains, among other information, the FCC equivalence number (REN) for this equipment. If requested, this information must be provided to the telephone company.

The REN is used to determine the quantity of devices that may be connected to the telephone line. Excessive RENs on the telephone line may result in the devices not ringing in response to an incoming call. In most, but not all areas, the sum of the RENs should not exceed five. To be certain of the number of devices that may be connected to the line, as determined by the total RENs, contact the telephone company to determine the maximum REN for the calling area.

If the terminal equipment causes harm to the telephone network, the telephone company will notify you in advance that temporary discontinuance of service may be required. But if advance notice is not practical, the telephone company will notify the customer as soon as possible. Also, you will be advised of your right to file a complaint with the FCC if you believe it is necessary.

The telephone company may make changes in its facilities, equipment, operations or procedures that could affect the operations of the equipment. If this happens, the telephone company will provide advance notice in order for you to make the necessary modifications in order to maintain uninterrupted service.

If trouble is experienced with this equipment, please contact the store, reseller, or agent from whom the product was purchased.

Repair of this equipment should be made only by the 2Wire Service Center or a 2Wire authorized agent.