

EZ Connect[™] Wireless Cable Modem Gateway

Install Guide

SMC8014W-G

Copyright

Information furnished by SMC Networks, Inc. (SMC) is believed to be accurate and reliable. However, no responsibility is assumed by SMC for its use, nor for any infringements of patents or other rights of third parties which may result from its use. No license is granted by implication or otherwise under any patent or patent rights of SMC. SMC reserves the right to change specifications at any time without notice.

Copyright © 2006 by
SMC Networks, Inc.
38 Tesla
Irvine, California 92618

All rights reserved.

Trademarks

Information furnished by SMC Networks, Inc. (SMC) is believed to be accurate and reliable. However, no responsibility is assumed by SMC for its use, nor for any infringements of patents or other rights of third parties which may result from its use. No license is granted by implication or otherwise under any patent or patent rights of SMC. SMC reserves the right to change specifications at any time without notice.

TABLE OF CONTENTS

CHAPTER 1 | Introduction

- Features and Benefits
- Package Contents
- Minimum Requirements

CHAPTER 2 | Getting to know the EZ Connect™ Wireless Cable Modem Gateway

- LED Indicators
- Rear Panel Description
- Resetting and Restoring the EZ Connect™ Wireless Cable Modem Gateway

CHAPTER 3 | Installation

- Basic Installation Procedure

CHAPTER 4 | Configuring your Computer

- Configuring Windows 95/98/Me
- Configuring Windows 2000
- Configuring Windows XP
- Configuring a Macintosh Computer

CHAPTER 5 | Configuring the EZ Connect™ Wireless Cable Modem Gateway

- Browser Configuration
- Disable Proxy Connection
- Accessing the EZ Connect™ Wireless Cable Modem Gateway Web Management

CHAPTER 6 | Navigating the Web-based Administration

- Making Configuration Changes
- System
- WAN
- LAN
- Routing
- Wireless
- NAT
- Firewall
- Tools
- VPN
- Status

APPENDIX A | Telnet/CLI Information

APPENDIX B | Troubleshooting

APPENDIX C | Technical Specifications

APPENDIX D | Compliances

APPENDIX E | Technical Support

CHAPTER 1 | Introduction

Congratulations on your purchase of the EZ Connect™ Wireless Cable Modem Gateway. SMC is proud to provide you with a powerful yet simple communication device for connecting your local area network (LAN) to the Internet.

Features and Benefits

- **EZ 3-Click Installation Wizard** - A new and improved way to install your Gateway Modem. In 3 simple clicks, you will be connected to the Internet.
- Internet connection to cable modem service via an integrated cable modem port
- Local network connection via 10/100 Mbps Ethernet ports or 54 Mbps wireless interface.
- 802.11g - interoperable with multiple vendors.
- Wireless: WEP and WPA encryption, Hide SSID, and MAC Filtering
- DHCP for dynamic IP configuration, and DNS for domain name mapping.
- Firewall with Stateful Packet Inspection, client privileges, hacker prevention, DoS, and NAT.
- Virtual Private Network (VPN) end-point support using PPTP, L2TP, or IPSec
- VPN pass-through support using PPTP, L2TP, or IPSec
- User-definable application sensing tunnel supports applications requiring multiple connections
- Built-in Parental controls allow you to limit certain web sites - configurable by time and date.
- Email alerts when hacking attempts on the users network are made
- Easy setup through a web browser on any operating system that supports TCP/IP
- Compatible with all popular Internet applications



Package Contents

Before installing the EZ Connect™ Wireless Cable Modem Gateway, verify that you have the items listed under below. Also be sure that you have the necessary cabling. If any of the items are missing or damaged, contact your local SMC distributor.

- 1 - EZ Connect™ Wireless Cable Modem Gateway
- 1 - Power adapter (12V/1.25A)
- 1 - CAT-5 Ethernet cable
- 1 - USB Cable
- Installation CD, including:
 - User Guide
 - USB Drivers

If possible, retain the carton and original packing materials in case there is a need to return the product.

Please register your product on SMC's web site at <http://www.smc.com>.

System Requirements

You must meet the following minimum requirements:

- Provisioned Internet access from a cable operator that has approved the SMC8014W-G
- A computer equipped with a wired or wireless network adapter with TCP/IP installed.
- A Java-enabled web browser, such as Microsoft Internet Explorer 5.5 or above, or Netscape Communicator 5.0 or above.
- Windows 98 Second Edition or higher is required for USB driver support.

CHAPTER 2 | Getting to Know the EZ Connect™ Wireless Cable Modem Gateway

The EZ Connect™ Wireless Cable Modem Gateway is the perfect all in one solution, for the home or business environment. This full-featured device has:

- An approved DOCSIS 1.1 and 2.0 Cable modem
- Advanced SPI Firewall Gateway
- High-speed 54 Mbps 802.11g Wireless Access Point
- Comprehensive LEDs for network status and troubleshooting
- Reset Button
- 4 - 10/100 Mbps Auto-Sensing LAN ports with Auto-MDI MDIX feature
- 1 - USB 1.1 LAN Port for PC connectivity

NOTE: Cable modems provide up to 38 Mbps downstream and 10 Mbps upstream. However, you should note that the actual rate provided by specific service providers may vary dramatically from these upper limits.

LED Indicators

The Gateway includes LED indicators on the front panel that simplify installation and network troubleshooting.



The Gateway includes LED indicators on the front panel that simplify installation and network troubleshooting.

LABEL	LED COLOR	ON	FLASHING	OFF
Power	Green	Power is supplied to the Gateway	N/A	Power is not supplied to the Gateway
Diag	Amber	System Failure. Reboot Gateway	N/A	Normal Operation
Cable	Green	Successfully connected to cable network	Attempting to connect to network	N/A
Traffic	Green	Cable Modem has finished CMTS registration	Attempting to register with CMTS	N/A
WLAN	Green	Good Wireless Link	Data transmitting	No Wireless Link
LAN (1-4)	Green	Connected at 10 or 100 Mbps	Data transmitting	No Ethernet link detected
USB	Green	USB port connected	Data transmitting	No USB link detected

Rear Panel Description

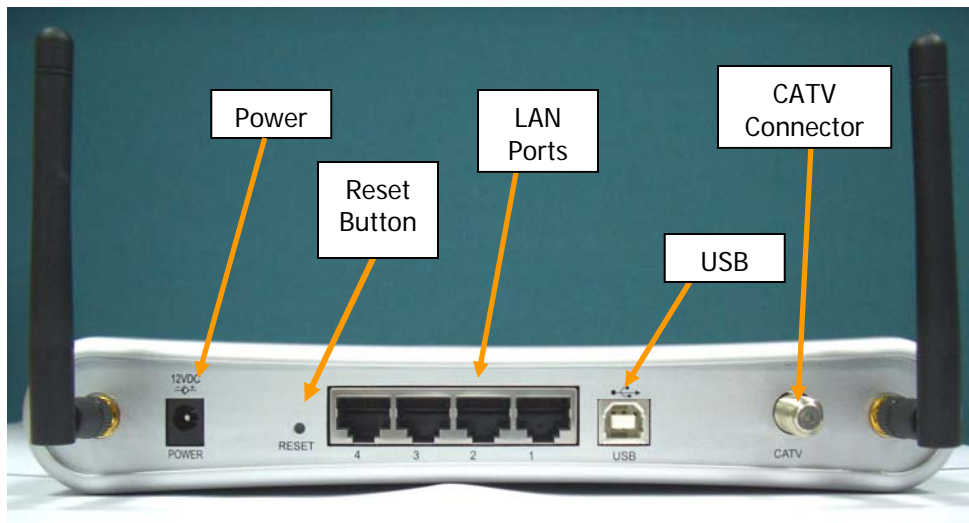

Item	Description
Power	Connect the included power adapter to this port.
Reset	Use this button to reset the power or restore the default factory settings.
LAN 1-4	Four 10/100 Auto-sensing switch ports (RJ-45). Connect devices on your local area network to these ports (such as a PC, hub, or switch).
USB	Connect a USB Cable from your PC to this port.
CATV	Connect your cable line to this port.

Rebooting and Restoring the EZ Connect™ Wireless Cable Modem Gateway

The Reset button is located on the rear panel of the Gateway. Use a paper clip or a pencil tip to push the Reset button.

Reboot

If the Gateway is having problems connecting to the Internet, simply hold down the reset button for less than 2 seconds then release.

Restore Factory Defaults

If rebooting the Gateway does not resolve your issue, then you can follow these steps:

1. Leave power plugged into the Gateway.
2. Locate the reset button on the back panel, press and hold button for at least 5 seconds.
3. Release reset button.

CHAPTER 3 | Installation

The EZ Connect™ Wireless Cable Modem Gateway can be installed in any location where you have cable Internet access, and your cable Internet service provider has approved the Gateway. To confirm you meet these 2 criteria points, please contact your cable operator.

For general installation please follow the guidelines outlined below to best performance:

- Keep the Gateway away from any heating devices.
- Do not place the Gateway in a dusty or wet environment.
- For optimum wireless performance, install the Gateway away from other electronic devices, such as Monitors / TV / 2.4GHz Cordless Phones. These devices can hamper your wireless throughput and distance.

Basic Installation Procedure

1. **Connect the LAN:** You can connect the Gateway to your PC, or to a hub or switch. Run Ethernet cable from one of the LAN ports on the rear of the Gateway to your computer's network adapter or to another network device. You can use either a standard straight through or cross over Ethernet cable since the Gateway incorporates Auto-MDI MDIX functionality.

You can also connect the Gateway to your PC (using a wireless client adapter) via radio signals.

NOTE: It is recommended that for first-time setup you use a wired connection.

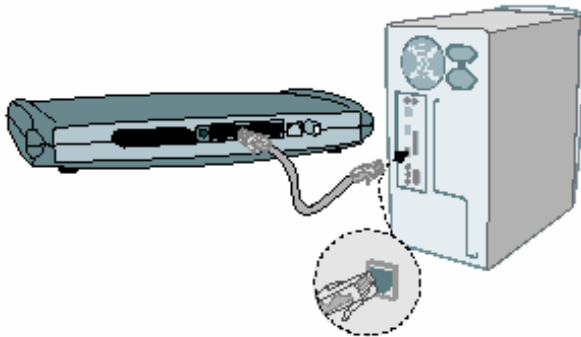

2. **Connect the WAN:** Connect a coax cable to the CATV port on the back of the Gateway from a cable port located in your home. When connecting to the CATV port, use only manufactured coaxial patch cables with F-type connectors at both ends for all connections.

Note: If this modem was NOT installed by your cable provider (ISP) or is being used to replace another cable modem - please contact your Cable Operator to register the SMC8014W-G. Without registering the modem with your cable operator it will be unable to connect to the cable network system.

3. **Power on:** Connect the power adapter to the Gateway.

Warning: Only use the power adapter that was provided with the Gateway, using another power adapter may damage your unit and void the warranty.

CHAPTER 4 | Configuring your Computer

The information outlined in this chapter will guide you through the configuration for the following Operating Systems:

- Windows 95/98
- Windows Me
- Windows 2000
- Windows XP
- Apple Macintosh

Configuring Windows 95/98/Me

1. Access your Network settings by clicking [Start], choose [Settings], and then select [Control Panel].
2. In the Control Panel, locate and double-click the [Network] icon.
3. Highlight the TCP/IP line that has been assigned to your network card on the [Configuration] tab of the [Network] properties window. (see network dialog box to the right)
4. Next, click the [Properties] button to view that adapter's TCP/IP settings.
5. From the TCP/IP Properties dialog box, click the [Obtain an IP address automatically] option. (see TCP/IP dialog box to the right)
6. Next click on the [Gateway] tab and verify the Gateway field is blank. If there are IP addresses listed in the Gateway section, highlight each one and click [Remove] until the section is empty.
7. Click the [OK] button to close the TCP/IP Properties window.
8. On the Network Properties Window, click the [OK] button to save these new changes.

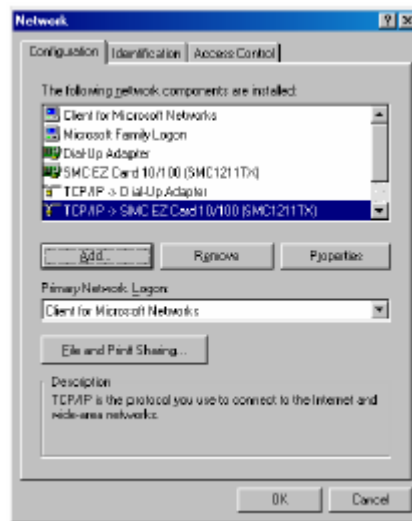

NOTE: Windows may ask you for the original Windows installation disk or additional files. Check for the files at `c:\windows\options\cabs`, or insert your Windows CD-ROM into your CD-ROM drive and check the correct file location, for example, `D:\win98`, `D:\win9x`. (Assume "D" is your CD-ROM drive).

9. Windows may prompt you to restart the PC. If so, click the [Yes] button. If Windows does not prompt you to restart your computer, do so anyways to ensure your settings.

Configuring Windows 2000

1. Access your Network settings by clicking [Start], choose [Settings], and then select [Control Panel]
2. In the Control Panel, locate and double-click the [Network and Dial-up Connections] icon
3. Locate and double-click the [Local Area Connection] icon for the Ethernet adapter that is connected to the Gateway. When the Status dialog box window opens, click the [Properties] button.
4. On the [Local Area Connection] Properties box, verify the box next to Internet Protocol (TCP/IP) is checked. Then highlight the Internet Protocol (TCP/IP), and click the Properties button.
5. Select Obtain an IP address automatically to configure your computer for DHCP. Click the [OK] button to save this change and close the Properties window.
6. Click the [OK] button again to save these new changes.
7. Reboot your PC.

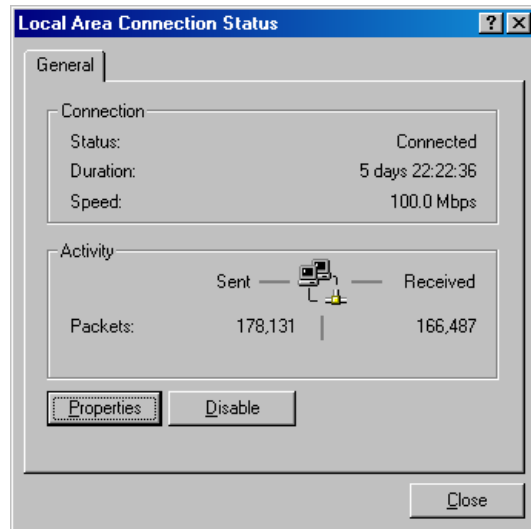

Configuring Windows XP

The following instructions assume you are running Windows XP with the default interface. If you are using the Classic interface (where the icons and menus look like previous Windows versions), please follow the instructions for Windows 2000 outlined above.

1. Access your Network settings by clicking [Start], choose [Control Panel], select [Network and Internet Connections] and then click on the [Network Connections] icon.
2. Locate and double-click the Local Area Connection icon for the Ethernet adapter that is connected to the Gateway. Next, click the [Properties] button.
3. On the [Local Area Connection] Properties box, verify the box next to Internet Protocol (TCP/IP) is checked. Then highlight the Internet Protocol (TCP/IP), and click the Properties button.
4. Select Obtain an IP address automatically to configure your computer for DHCP. Click the [OK] button to save this change and close the Properties window.
5. Click the [OK] button again to save these new changes.

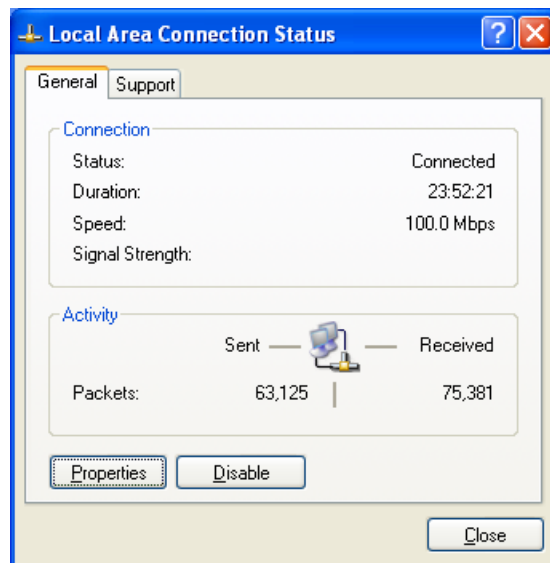

6. Reboot your PC.

Configuring a Macintosh Computer

You may find that the instructions here do not exactly match your screen. This is because these steps and screen shots were created using Mac OS 10.2. Mac OS 7.x and above are all very similar, but may not be identical to Mac OS 10.2.

1. Pull down the Apple Menu. Click System Preferences and select Network. Make sure that
2. Built-in Ethernet is selected in the Show field.
3. On the TCP/IP tab, select Using DHCP in the Configure field.
4. Close the TCP/IP dialog box.

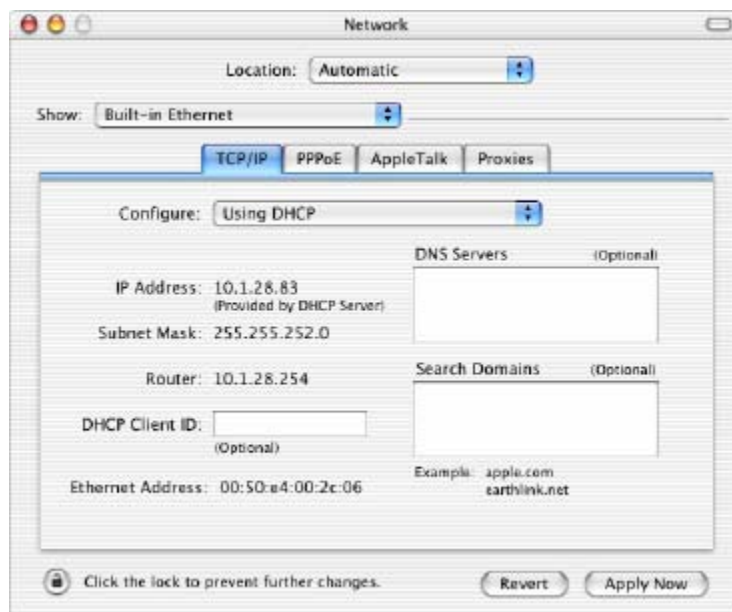

CHAPTER 5 | Configuring the EZ Connect™ Wireless Cable Modem Gateway

After you have configured TCP/IP on a client computer, use a web browser to configure the EZ Connect™ Wireless Cable Modem Gateway. The Gateway can be configured by any Java-supported browser including Internet Explorer 5.0 or above, or Netscape Navigator 5.0 or above. Using the web management interface, you can configure the Gateway features and view its settings.

Before you attempt to log into the Gateway's Web-based Administration, please verify the following:

1. Your browser is configured properly. (see below)
2. Disable any firewall or security software that may be running.
3. Confirm that you have a [link] LED where your computer is plugged into the Gateway. If you don't have a [link] light, try another cable.

Browser Configuration

Confirm your browser is configured for a direct connection to the Internet using the Ethernet cable that is installed in the computer. This is configured through the options/preference section of your browser.

Disable Proxy Connection

You will also need to verify that the "HTTP Proxy" feature of your web browser is disabled. This is so that your web browser will be able to view the web-based configuration pages. The following steps are for Internet Explorer and for Netscape. Determine which browser you use and follow the appropriate steps.

Internet Explorer (5.0 or above)

1. Open Internet Explorer. Click [Tools], and then select [Internet Options].
2. In the [Internet Options] window, click the [Connections] tab.
3. Click the [LAN Settings] button.
4. Clear all the check boxes and click [OK] to save these LAN settings changes.
5. Click [OK] again to close the [Internet Options] window.

NOTE: To ensure proper screen refresh after a command entry, be sure that Internet Explorer 5.0 is configured as follows: Under the menu "Tools/Internet Options/General/Temporary Internet Files/Settings," the setting for "Check for newer versions of stored pages" should be "Every visit to the page."

Netscape (5.0 or above)

1. Open Netscape. Click [Edit], and then select [Preferences].
2. In the [Preferences] window, under [Category], double-click [Advanced], then select the [Proxies] option.
3. Check [Direct connection to the Internet].
4. Click the [OK] button to save the changes.

Accessing the EZ Connect™ Wireless Cable Modem Gateway's Web Management

To access the EZ Connect™ Wireless Cable Modem Gateway's web-based management screens, follow the steps below:

1. Launch your web-browser.

NOTE: Your computer does not have to be ONLINE to configure the EZ Connect™ Wireless Cable Modem Gateway.

2. In the Address Bar, type: `http://192.168.0.1`



3. When the Gateway's Login screen appears, enter the default username and password, and click the [Login] button to access the Gateway.

A screenshot of a web-based login screen. The screen has a blue header with the text "LOGIN USER PASSWORD". Below the header, the title "Login Screen" is centered. There are two input fields: "Username:" followed by a white text box, and "Password:" followed by a white text box. Below the input fields are two buttons: "LOGIN" and "CANCEL".

There are 2 default login accounts, one for the User and one for the Installer:

Installer Login - for use by cable operator only

USERNAME: mso

PASSWORD: msopassword

User Login - for use by subscriber

USERNAME: cusadmin

PASSWORD: password

NOTE: Usernames and Passwords are case sensitive

4. Once you have logged into the Gateway's web-based admin screen, you have several options and features which can be configured.

All features available and how to configure each one is outlined in the next section
Chapter 6 | Navigating the Web-based Administration.

CHAPTER 6 | Navigating the Web-based Administration

The EZ Connect™ Wireless Cable Modem Gateway's management interface allows you to configure both basic and advanced features and options. Some of these advanced functions include: hacker attack detection, IP and MAC address filtering, intrusion detection, port forwarding setup, virtual DMZ hosts, as well as other advanced functions.

Making Configuration Changes

Once a configuration change has been made on a page, be sure to click the [Apply] or [Next] button at the bottom of the page to enable the new setting.

SYSTEM

This section is used to configure the device mode and administration options including passwords and remote management settings.

To access the System Settings configuration page, on the Side Navigation bar, click on [System] link.

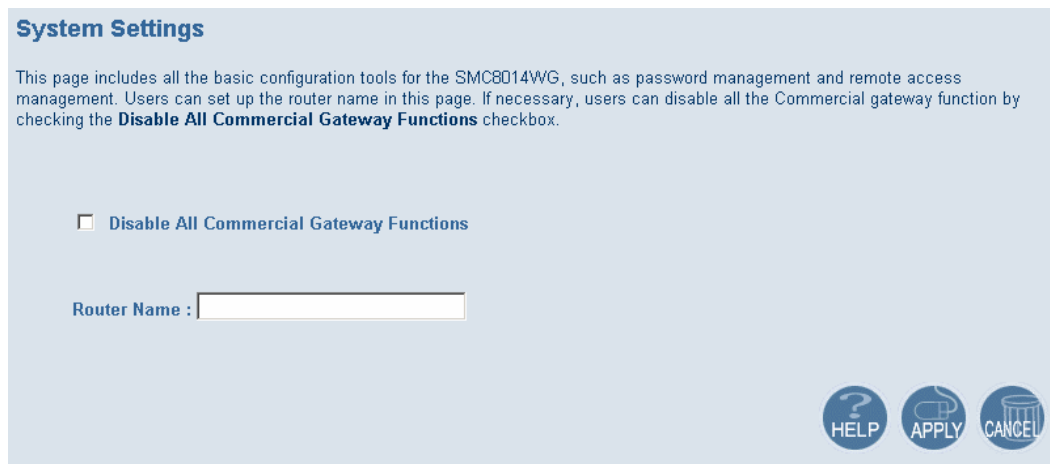

System Settings

This page includes all the basic configuration tools for the SMC8014WG, such as password management and remote access management. Users can set up the router name in this page. If necessary, users can disable all the Commercial gateway function by checking the **Disable All Commercial Gateway Functions** checkbox.

Disable All Commercial Gateway Functions

Router Name :

HELP APPLY CANCEL

Selecting the [Disable ALL Commercial Gateway Functions] sets the Gateway to operate as a bridging cable modem. In this mode all LAN interfaces are enabled including Ethernet, USB, and Wireless, but all Gateway functions are disabled including Firewall, NAT, DHCP Server, URL Blocking, and VPN end points.

A Router Name for the Gateway can also be set on this page.

Password Settings

From this section you can configure new passwords for the [mso] and [cusadmin] administrator accounts.

You can also set the Idle Time Out value that the SMC8014W-G will keep an admin account logged in for. The default Idle Time Out value is 10 min.

To access the Password Settings configuration page, on the Side Navigation bar, click on [System] link and then click on the [Password Settings] link.

Password Settings

Set a password to restrict management access to the SMC8014WG. Also a timeout value could be set here for automatic logout if the page is not active for the timeout period.

- Current Password :
 - New Password :
 - Re-Enter Password for Verification :
 - Customer New Password :
 - Re-Enter Customer New Password for Verification :
- Idle Time Out : Min

If your password is lost, or you cannot gain access to the user interface, press the Reset button on the rear panel (holding it down for at least five seconds) to restore the factory defaults.

From this section you can also configure the RADIUS, TACACS+ and TACACS authentication. Note: only one form of authentication can be enabled at any one time.

RADIUS Authentication

RADIUS Server IP	<input type="text" value="0"/> <input type="text" value="0"/> <input type="text" value="0"/> <input type="text" value="0"/>
Port	<input type="text" value="1812"/>
Authentication Algorithm	<input type="text" value="CHAP"/>
Key	<input type="text" value="••••••"/>
Timeout	<input type="text" value="3"/> seconds
Retry	<input type="text" value="3"/> times

TACACS+ Authentication

TACACS+ Server IP	<input type="text" value="0"/> <input type="text" value="0"/> <input type="text" value="0"/> <input type="text" value="0"/>
Port	<input type="text" value="49"/>
Authentication Algorithm	<input type="text" value="ASCII"/>
Shared Secret	<input type="text" value="••••••"/>

TACACS Authentication

TACACS Server IP	<input type="text" value="0"/> <input type="text" value="0"/> <input type="text" value="0"/> <input type="text" value="0"/>
Port	<input type="text" value="49"/>
Authentication Algorithm	<input type="text" value="Authentication"/>
Line	<input type="text" value="1"/>
Style	<input type="text"/>

Remote Management

Allows a remote PC to configure, manage, and monitor the Gateway using a standard web browser.

To access the Remote Management configuration page, on the Side Navigation bar, click on [System] link and then click on the [Remote Management] link.

If users on the Internet want to remotely manage the SMC8014WG, there are two ways, telnet and web, for them. For remote web management, they must specify the WAN IP and the specific remote management port for the URL. Or they can telnet to the device by using the WAN IP and the specific remote telnet management port which is between 1 and 65535. If users want to change the default port, the range of the remote management port is between 1024 and 65535 for HTTP. The web default port is 8080 and telnet port is 2323. For example, if the WAN IP is 123.45.67.8 and web management port is 8080, the remote user must use "http://123.45.67.8:8080" to access the SMC8014WG's web management function.

WAN IP Address	20.20.20.1		
Http Port	<input type="text" value="8080"/>		<input type="checkbox"/>
Telnet Port	<input type="text" value="2323"/>		<input type="checkbox"/>
Https Port	<input type="text" value="8181"/>		<input type="checkbox"/>
Mso remote management	<input checked="" type="checkbox"/>		
Customer remote management	<input type="checkbox"/>		

Limit remote management to:

All IP Addresses

Single Address . . . to . . .

Permitted IP Addresses:

This feature has several options to configure:

- Configure the HTTP remote management port (default port: 8080)
- Configure the Telnet remote management port (default port: 2323)
- Configure the HTTPS remote management port (default port: 8181)
- Specify if MSO remote management is allowed (i.e. "mso" login)
- Specify if Customer remote management is allowed (i.e. "cusadmin" login)
- Customize the remote management access list (default: All IP addresses)

HTTP Remote Management

The default setting for this is enabled on port 8080. To access the remote management web page you would access it at <http://xxx.xxx.xxx.xxx:8080> (where xxx.xxx.xxx.xxx is your WAN IP listed on the status page). If you change the port to another setting then simply change the information in the URL.

NOTE: Do not set the remote management port to use a port that is already in use by the gateway or PC on the private LAN. For example, if a remotely accessible WEB or FTP server is running on the private LAN (i.e. a Port Forwarding rule has already been created for this service) you cannot set the remote management port to 80, 20, or 21.

Telnet Remote Management Port

The default setting for this is disabled on port 2323. Telnet enables access to the Command Line Interface (CLI). Refer to Appendix A for CLI commands.

Enable Customer Remote Management

This feature enables the customer to remotely access the web-based administration screen with their username and password (default: cusadmin/password). To enable this feature, check the [Customer Remote Management] checkbox.

Remote Management Access Rule

This option will allow you to limit who can access the remote management web login from the Internet.

The [Everyone] option allows any Internet user to access the web management login.

The [IP address range] option allows you to set a range of public Internet IP addresses. You can access the web management login from any IP address in the specified range.

The [Single Address] option allows you to set just 1 public Internet IP address. This is the ONLY IP address that you access the web management login screen.

A combination of one or more IP address ranges and single addresses can be configured.

WAN

From this section you can configure all the WAN Settings.

To access the WAN configuration page, on the Side Navigation bar, click on [WAN] link.

You can setup the SMC8014W-G to support the Public LAN IP as the WAN IP by selecting the [Use public LAN IP as the WAN IP] checkbox. The Public LAN IP can be configured in the LAN Settings section.

Click the DHCP WAN IP [Release/Renew] button to release and renew the WAN IP address.

DNS Settings

You can also configure the Gateway to use custom DNS servers.

NOTE: DNS is short for Domain Name System. The DNS IP is a server that translates domain names into IP addresses.

Host Name

The Host Name setting is an optional configuration and is used when required by your cable operator. Contact your cable operator to determine if this setting is required.

MAC Spoofing

This is an optional configuration that may or may not be required by your cable operator. For more information about MAC Clone/Spoofing please contact your cable operator to determine if this is a required setting.

To access the MAC Spoofing configuration page, on the Side Navigation bar, click on [WAN] link and then click on the [MAC Spoofing] link.



MAC Spoofing

If users want to use DHCP to get the WAN IP for NAT translation, some cable Internet companies will only assign IP for a particular MAC address, i.e. the NIC card's MAC address of the user's PC. In such scenario, MAC Cloning allows the user to substitute a different MAC address for the factory default WAN MAC address.

If users choose to use the public static LAN IP as the WAN IP for NAT translation, then no spoof MAC is necessary and the fields below would be dimmed to prohibit the input.

MAC Address List:

Clone MAC Address :

LAN

From this section you can configure the following settings:

- The **PUBLIC** LAN IP settings, including IP Address, Subnet Mask, and Domain Name - this option can also be enabled to act as the WAN IP.
- The **PRIVATE** LAN IP settings, including IP Address, Subnet Mask, and Domain Name.
- Enable or Disable the integrated DHCP server
- Configure the DHCP Lease time for your DHCP clients
- The IP Address Pool range for DHCP clients
- The PPTP IP Address Pool for PPTP VPN clients

To access the LAN configuration page, on the Side Navigation bar, click on [LAN] link.

LAN IP

Use the LAN section to configure the LAN IP address for the Gateway and to enable the DHCP server for dynamic client address allocation. You can also configure the Lease Time for the DHCP clients on your network.

Public LAN IP Settings

Define a range of public IPs that are used on the LAN. The combination of IP address and Subnet Mask settings determine the Public LAN subnet and IP addresses within this network are assigned to servers on the LAN. Optionally, the Public LAN IP address can be used as the Gateway's WAN IP address.

LAN Settings

Users can set up the public LAN IP, also the private LAN IP in this page. The private LAN IP is also the IP of the DHCP server which will dynamically allocate IP address for the client PCs behind the Gateway. The private IP range is a class C address which can be set up from 2 to 254. The default address pool is from 10 to 59.

Public LAN IP

IP address	<input type="text" value="20"/> <input type="text" value="20"/> <input type="text" value="20"/> <input type="text" value="1"/>
IP Subnet Mask	<input type="text" value="255"/> <input type="text" value="255"/> <input type="text" value="255"/> <input type="text" value="0"/>
Domain Name	<input type="text" value="mypubgateway.net"/>
As WAN IP	<input type="checkbox"/>

Private LAN IP Settings

Define the Gateway's private LAN settings. The IP address configured here is the Gateway's (default: 192.168.0.1).

NOTE: Port Forwarding and Access Control rules will be based on the network scope defined here. If either of these types of rules were previously setup and the Private LAN IP address is changed, then those rules will need to be recreated to reflect the new Private LAN IP network.

Private LAN IP

IP address	<input type="text" value="192"/> <input type="text" value="168"/> <input type="text" value="0"/> <input type="text" value="1"/>
IP Subnet Mask	<input type="text" value="255"/> <input type="text" value="255"/> <input type="text" value="255"/> <input type="text" value="0"/>
Domain Name	<input type="text" value="mygateway.net"/>

DHCP Server Settings

The Gateway's DHCP Server can be turned enabled/disabled here. Also the DHCP client Lease Time can be adjusted from the default One Week setting. The Gateway functions as a DNS proxy by default. DNS proxy can be disabled by configuring Primary and Secondary DNS values here, which LAN DHCP clients will receive in their lease.

Enable DHCP Server	<input checked="" type="checkbox"/>
Lease Time	<input type="text" value="One Week"/>
Assign DNS Manually	<input type="checkbox"/>
Primary DNS	<input type="text" value="0"/> <input type="text" value="0"/> <input type="text" value="0"/> <input type="text" value="0"/>
Secondary DNS	<input type="text" value="0"/> <input type="text" value="0"/> <input type="text" value="0"/> <input type="text" value="0"/>

Private IP Address Pool

The scope of LAN DHCP IP addresses that the Gateway will assign to clients is 192.168.0.10 to 192.168.0.59 by default. IP addresses from 192.168.0.2 to 192.168.0.9 and from 192.168.0.230 to 192.168.0.254 are available for static IP address assignments.

Private IP Address Pool

Start IP	192	168	0	10
End IP	192	168	0	59

NOTE: You cannot use the IP address of the Gateway (192.168.0.1 - default IP) in the client address pool.

PPTP IP Address Pool

When the Gateway is configured to act as a PPTP VPN server in the VPN Settings section, PPTP clients will be assigned IP addresses in this range for their PPTP WAN interface.

PPTP IP Address Pool

Start IP	10	1	10	200
End IP	10	1	10	229

ROUTING

From this section you can configure Static Routes and RIP Control settings.

Static Routes

Use this section to configure Static Routes on your network. A static route setting will allow you to configure a different Gateway for a Specific Destination IP.

To access the Static Routes configuration page, on the Side Navigation bar, click on the [WAN] link and then select the [Static Route] link.

Static Routes

This page allows the user to add static routes to assign specific paths to networks connected to the LAN.

Static Routing Table (up to 8 items)

#	Name	Destination IP	Subnet Mask	Gateway IP	Active
<input type="button" value="Add"/> <input type="button" value="Edit"/> <input type="button" value="Delete"/>					



NOTE: Users cannot add any static routes to a public network assigned by your cable operator. Users can add other private networks that are located on the LAN side of the SMC8014W-G.

Adding Static Routes

The screen shot below shows the Configuration Page for adding a Static Route to your network. To access this screen, click on the [Add] button from the main [Static Routes] page (shown above).

Add Static Routes

In this page, users can add static routes to the routers connected to the SMC8014WG, containing different networks and subnets. Users can specify a name for the route as a way to easily remember which entry is linked to which route. The Destination IP and its Subnet Mask are the network IP address of the destination network and its subnet mask. The Gateway IP is the locally-assigned IP address on the Gateway LAN network. For example, a router 'SMC' is connected to the SMC8014WG, which has a subnet address '111.222.33.0' attached to it, and its IP in the SMC8014WG subnet is '192.168.100.33'. We can add a static route called 'SMC' and its destination IP is '111.222.33.0', subnet mask is '255.255.255.0' and its gateway IP is '192.168.100.33'.

Name	<input type="text"/>
Destination IP	<input type="text"/> . <input type="text"/> . <input type="text"/> . <input type="text"/>
Subnet Mask	<input type="text"/> . <input type="text"/> . <input type="text"/> . <input type="text"/>
Gateway IP	<input type="text"/> 192 <input type="text"/> 168 <input type="text"/> . <input type="text"/> . <input type="text"/> . <input type="text"/>



RIP Control

Use this section to configure the RIP control settings. RIP is used by some cable operators to advertise Public LAN IPs to their network. Below is an outline of the RIP control options:

- 1. RIP Send Version:**
Options are to send *RIP1* / *RIP2* / *RIP1 and RIP2* / *DO NOT SEND*.
- 2. RIP Receive Version:**
Options are to receive *RIP1* / *RIP2* / *RIP1 and RIP2* / *DO NOT RECEIVE*.
- 3. Update Interval:**
Time period for RIP daemon to send out its routing information to other routers.
- 4. Default Metric:**
This variable indicates the metric that is to be used for the default route entry in RIP updates originated on this interface. A value of zero indicates that no default route should be originated. For CM, it is not necessary to send out its own default route to the CMTS. So, this value should be zero.
- 5. Authentication Type (only for RIPv2):**
This value is used when users choose RIP2 for the RIP SEND/RECEIVE. The options are *No authentication* / *Simple Password* / *MD5*. The Simple Password option uses a clear text password. Usually, MD5 is preferred for security reason. Please be aware that the CMTS's RIP setting must match with the CM's RIP setting.
- 6. Authentication Key & ID (only for RIPv2):**
These two values are used with item 5 above. If "Simple Password" or "MD5" is chosen for authentication type, they must match the values set in the CMTS.
- 7. Neighbor:** Usually RIP are sent out by broadcast or multicast. If users want to unicast the RIP to a specific neighbor router, they can specify the destination IP here. Then only that particular neighbor router would receive the RIP messages.

NOTE: It is best to use RIP2 when using non-classful IP addresses. In other words, use RIP2 for those networks that are subnetted (e.g. a subnet mask other than 255.0.0.0 for a Class A IP address). RIP1 does not support classless inter-domain routing (CIDR) which is the method used to subdivide networks with subnet masks.

To configure the RIP settings via Web UI, please follow the steps outlined below:

1. You will need to confirm the network is setup with a valid Public LAN IP in [LAN] page before they enable the RIP setting.

NOTE: The RIP setting is disabled by default.

LAN Settings

Users can set up the public LAN IP, also the private LAN IP in this page. The private LAN IP is also the IP of the DHCP server which will dynamically allocate IP address for the client PCs behind the Gateway. The private IP range is a class C address which can be set up from 2 to 254. The default address pool is from 10 to 59.

Public LAN IP

IP address	<input type="text" value="20"/> <input type="text" value="20"/> <input type="text" value="20"/> <input type="text" value="1"/>
IP Subnet Mask	<input type="text" value="255"/> <input type="text" value="255"/> <input type="text" value="255"/> <input type="text" value="0"/>
Domain Name	<input type="text" value="mypubgateway.net"/>
As WAN IP	<input type="checkbox"/>

2. After you confirm the LAN Settings, then you will need to configure the RIP Settings.

RIP Control

This page allows the users to control the RIP protocol which could be used to exchange the routing information between routers. The routing information could be used to build up/modify/age out the routes dynamically.

RIP Control Table

Interface Name	Cable		
RIP Send Version	Do Not Send		
RIP Receive Version	Do Not Receive		
Update Interval	<input type="text" value="30"/>	sec	
Default Metric	0		
Authentication Type	MD5		
Authentication Key & ID	Key: <input type="text" value="XXXXXXXXXX"/>	ID:	<input type="text" value="0"/>
Neighbor	<input type="text"/>	<input type="text"/>	<input type="text"/>

?
APPLY
CANCEL

These settings will need to be configured based on how your cable operator network is set up.

WIRELESS

This section allows you to configure the Gateway's built-in 54 Mbps 802.11g Access Point. To setup the wireless connections, you will need to do define the Service Set Identifier (SSID), Channel, Encryption options, and other optional settings.

To access the Wireless Settings page shown below, on the Side Navigation bar, click on [Wireless] link.

The Wireless Mode can be set to Mixed (default), 11B only, 11B+ only, or 11G only. Also, the Gateway's wireless interface can be disabled if not being used.

Wireless Settings

The gateway can be quickly configured as a wireless access point for roaming clients by setting the access identifier and channel number. It also supports data encryption and client filtering. Users could also choose which mode would be run for this access point. There are 11b, 11b+, 11g, or mixed mode. If necessary, users can also disable the wireless module by checking the **Disable Wireless Module** checkbox.

Mixed mode 11B only 11B+ only 11G only

Disable Wireless Module

HELP APPLY CANCEL

Channel and SSID

You must specify a common radio channel and SSID (Service Set ID) to be used by the Gateway and all of your wireless clients. Be sure you configure all of your clients to the same values.

To access the Channel and SSID configuration page, on the Side Navigation bar, click on [Wireless] link and then click on the [Channel and SSID] link.

Channel and SSID

This page allows you to define SSID and Channel ID for wireless connection. In the wireless environment, this gateway can be acting as a wireless access point. These parameters are used for the mobile stations to connect to this access point.

SSID	<input type="text" value="WLAN"/>
Channel	<input type="text" value="1"/>

Hide SSID

HELP APPLY CANCEL

SSID: This is the Wireless ID or Service Set ID of your wireless network. This should be set to the same value as the other wireless devices in your network.

NOTE: The SSID is case sensitive and can consist of up to 32 alphanumeric characters.

Channel: The radio channel through which the Gateway communicates to clients over the wireless network.

NOTE: If you are not getting good wireless performance try another wireless channel - because this Gateway operates in the 2.4GHz spectrum - it can be affected by some other products, such as cordless phones.

Hide SSID: This option will cause the Gateway to not broadcast its SSID. By selecting this option, wireless clients will not be able to use their Site Survey feature to locate this wireless network.

Encryption

If you are transmitting sensitive data across wireless channels, you should enable either Wired Equivalent Privacy (WEP) or WiFi Protected Access (WPA) encryption. Encryption requires you to use the same set of encryption/decryption keys for the Gateway and all of your wireless clients.

To access the Encryption configuration page, on the Side Navigation bar, click on [Wireless] link and then click on the [Encryption] link.

WEP

Select [WEP] from the [Encryption Type] drop down menu. Select the Automatic, Open System, or Shared Key from the [WEP Authentication Type] drop down menu.

You can choose between standard 64-bit or 128-bit encryption keys. Below are the configuration options for 64-bit WEP. A passphrase or a manual key can be used.

NOTE: To enter a manual WEP key you will need to enter hexadecimal values (A-F and 0-9).

To automatically generate a 64-bit WEP key, enter in a Passphrase (keyword - ex. Home) and click the [Generate Keys] option. Once you do this, the Gateway will dynamically generate 4

keys. Simply configure the Default Key to the one key that you will be using across your network.

On the wireless clients, you can use the passphrase option, and client utility will generate the same 4 keys - or you can manually type in the selected KEY that is configured on the Gateway.

For more security, you can use 128-bit WEP encryption. To use this mode, click the [128 Bit Encryption] option and the configuration section will be displayed. You can manually enter in the 26-digit hexadecimal key or use the passphrase option to generate random dynamic keys.

WEP KEY

64 Bit

128 Bit

Key 1	<input type="text" value="0x00000000000000000000000000000000"/>
Key 2	<input type="text" value="0x00000000000000000000000000000000"/>
Key 3	<input type="text" value="0x00000000000000000000000000000000"/>
Key 4	<input type="text" value="0x00000000000000000000000000000000"/>
Default Key	<input type="text" value="1"/>

Passphrase

Generate Keys

NOTE: If you are having a difficult time getting the wireless connection up after enabling WEP - please confirm that you have configured the SAME WEP key on both the Gateway and Client card.

WPA-PSK

Select [WPA-PSK] from the [Encryption Type] drop down menu. Next, enter a passphrase value between 8 and 63 characters in the [WPA Passphrase] field.

Security

Authentication Type

WPA Passphrase

MAC Filtering

The Gateway can allow the wireless client stations to connect over a wireless connection in 2 different ways:

1. By allowing all wireless stations access;
2. Or by allowing only Trusted PCs.

To access the MAC Filtering configuration page, on the Side Navigation bar, click on [Wireless] link and then click on the [MAC Filtering] link.

MAC Filtering

The SMC8014WG can allow the wireless client stations to connect to your SMC8014WG in any of these ways:

- All Wireless stations** Allow all wireless stations to access the Internet through the SMC8014WG.
- Trusted PCs only** Allow some particular wireless client stations to access the Internet through the SMC8014WG. You can use the following table to add/delete the clients.

Wireless Access List (up to 16 items)

#	Device Name	MAC Address
Delete		

Auto-Learned Wireless Devices

Device Name	MAC Address
-------------	-------------

Manually-Added Wireless Devices

Device Name	MAC Address
<input type="text"/>	<input type="text"/> : <input type="text"/> : <input type="text"/> : <input type="text"/> : <input type="text"/> : <input type="text"/>

Add Cancel

You can also configure a [Device Name] that is associated with a specific MAC address. In doing this, you can easily recognize the computers that you are in your access list.

NOTE: MAC filtering only applies to Wireless Clients.

NAT

Network Address Translation (NAT) allows multiple users at your local site to access the Internet through a single public IP address.

Port Forwarding

The Gateway supports port forwarding that enables customers to host servers on their LAN. You can configure this feature to redirect the external service request to the appropriate internal server and port.

For example, if you are running a WEB server, you can configure all traffic on port 80 to be redirected to the IP address of the WEB server running on your network.

To access the Port Forwarding configuration page, on the Side Navigation bar, click on [NAT] link and then click on the [Port Forwarding] link.

Port Forwarding

Users can configure the SMC8014WG to provide the port forwarding services which allow the Internet users to access local services such as the Web server or FTP server at your local site. This is done by redirecting the combination of the WAN IP address and the service port to the local private IP and its service port. The maximum total number allowed for predefined and customer-defined services is 100.

Predefined Service Table

#	Service Name	LAN Server IP	Remote IPs	Active
---	--------------	---------------	------------	--------

Customer Defined Service Table

#	Service Name	Type	LAN Server IP	Remote IPs	Public Port	Private Port	Active
---	--------------	------	---------------	------------	-------------	--------------	--------



This Port Forwarding function supports 2 types of Services:

- Predefined Service
- Customer Defined Service

Predefined Service

The Predefined Service option has a pull-down menu with several popular Service Applications, such as HTTP (80), FTP (20/21), and AIM/ICQ (5190).

Predefined Service

Predefined service allows users to choose the traffic type to be allowed-in from Internet.

Service	AIM/ICQ(TCP:5190)
LAN Server IP	192 . 168 . 0 .
Remote IPs	Any
Start IP	0 . 0 . 0 . 0
End IP	0 . 0 . 0 . 0

To configure Port Forwarding with a Predefined Service rule, follow the steps below:

1. Select the [Service] that you want to have access through the firewall to your LAN from the pull-down menu.
2. Enter in the [LAN Server IP] for the LAN PC that is running this service or application
3. You can also configure [Remote IPs] option to allow access to this specific port from the WAN side. This can be configured for 3 different access types:
 - a. Any IP Address [Any] - choose this option to allow access from any public IP address.
 - b. Single IP Address [Single Address] - choose this option to only allow access from a single public IP address.
 - c. IP Address Range [Address Range] - choose the option to only allow a range of public IP addresses.

- Click the [Apply] button to save your changes and return to the Port Forwarding main screen

Customer Defined Service Rule (Custom)

The Customer Defined Service section allows you to custom configure a Port Forwarding rule with any Traffic type (TCP/UDP/TCP and UDP), Public Port, and Private Port.

The screenshot shows a web interface titled "Customer Defined Service". Below the title is a subtitle: "Customer-defined service allows users to define their traffic type to be allowed-in from Internet." The form contains several fields:

- Name:** A text input field.
- Type:** A dropdown menu with "TCP" selected.
- LAN Server IP:** Four input fields for IP address, with "192" and "168" entered in the first two.
- Remote IPs:** A dropdown menu with "Any" selected.
- Start IP:** Four input fields for IP address, all set to "0".
- End IP:** Four input fields for IP address, all set to "0".
- Public IP Ports:** A dropdown menu with "Port Range" selected.
- Start Public Port:** An empty input field.
- End Public Port:** An empty input field.
- Private Ports:** An empty input field and a checkbox labeled "Enable Port Range".

At the bottom of the form are three buttons: "Back", "Apply", and "Cancel".

To configure this custom option, please follow the steps below:

- Enter in a Description [Name] for this custom setting
- Configure the Traffic or Data [Type] that you want to forward. The options are *TCP / UDP / TCP/UDP*.
- Set the [LAN Server IP] of the PC that you want this traffic/data redirected to
- You can also configure [Remote IPs] option to limit access to this specific port from the WAN side. This can be configured for 3 different access types:
 - Any IP Address [Any] - choose this option to allow access from any public IP address.
 - Single IP Address [Single Address] - choose this option to only allow access from a single public IP address.
 - IP Address Range [Address Range] - choose the option to only allow a range of public IP addresses.
- Set the [Start Public Port] and [End Public Port] that this application will use on the WAN (Internet) side. The Gateway will listen for incoming traffic/data to its WAN IP on these ports.
- Set the [Private Ports] that the Gateway will forward this traffic to on the LAN. If there is a range of ports, enter the starting private port in [Private Ports], select [Enable Port Range] checkbox, and the Gateway will automatically calculate the end private port. The LAN PC server will listen for traffic/data on this/these ports.

Below is an example setting for a WEB server on an Internet connection, where port 80 is blocked from the WAN side, but port 8000 is available.

Name: Web Server
Type: TCP
LAN Server IP: 192.168.0.100

Remote IPs: Any (allow access to any public IP)
Public Port: 8000
Private Port: 80

With this configuration, all HTTP (Web) TCP traffic on port 8000 from any IP Address from the WAN side will be redirected through the firewall to the Internal Server (192.168.0.100) on port 80.

NOTE: This configuration is useful because you don't have to reconfigure your web server to accept traffic on a different port, you can do this configuration on the Gateway.

FIREWALL

The Gateway provides a stateful inspection firewall (SPI), which is designed to protect against Denial of Service (DoS) attacks. Its purpose is to allow a private local area network (LAN) to be securely connected to the Internet. To provide a flexible solution, the firewall section has the following features:

Firewall Enable/Disable

To access the Security Settings configuration page, on the Side Navigation bar, click on [Firewall] link.

To enable this feature, check the [Enable Firewall Module] checkbox.

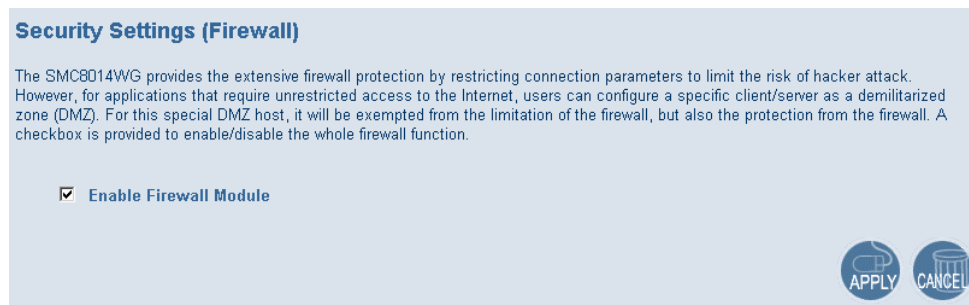

Access Control

The Access Control section allows the setting of two types of rules: enable access to services on your *public LAN* network from the Internet or to block services on the *private LAN* from accessing the Internet. Access Rules can be configured to a specific LAN IP Address or a range of LAN IP Address's.

To access the Access Control configuration page, on the Side Navigation bar, click on [Firewall] link and then click on the [Access Control] link.

To enable this feature, check the [Enable Access Control] checkbox.

There are 2 sections in that can be configured for Access Control Rules.

The first section is used to configure the Access Rules for the Public LAN from the Internet. These rules will enable services on the public LAN to be accessed by the Internet.

Access Control

By default all the access attempt from Internet to the LAN would be blocked no matter what destination it would be. In the NAT page, users can set up the port forwarding for the private LAN. Here, users can set up the accessing rules to allow the Internet users to access the public LAN service directly. The maximum total number allowed for predefined and customer-defined accessing rules is 35.

Enable Access Control

Predefined Service Table

#	Service Name	Remote IPs	Local IPs	Allowed
<input type="button" value="Add"/> <input type="button" value="Edit"/> <input type="button" value="Delete"/>				

Customer Defined Service Table

#	Service Name	Type	Remote IPs	Local IPs	Port	Allowed
<input type="button" value="Add"/> <input type="button" value="Edit"/> <input type="button" value="Delete"/>						

The second section is used to configure Access Rules for the Private LAN to the Internet. These rules will block services on the private LAN to the Internet.

The following two tables allow users to define the traffic type not-permitted from LAN site to the Internet. This page includes predefined IP filtering and customer-defined IP filtering. The maximum total number allowed for predefined and customer-defined filters is 35.

Predefined Filtering Table

#	Service Name	LAN IPs	Blocked
<input type="button" value="Add"/> <input type="button" value="Edit"/> <input type="button" value="Delete"/>			

Customer Defined Filtering Table

#	Service Name	Type	LAN IPs	Port	Blocked
<input type="button" value="Add"/> <input type="button" value="Edit"/> <input type="button" value="Delete"/>					

From this section, you can also choose to have the Gateway to [Respond to Ping on Internet WAN Port]. If you check this option, the Gateway will respond to PING requests to the WAN IP address. By default this option is enabled.

Respond to Ping on Internet WAN Port

For convenience, each Access Control section includes 2 filtering options:

- Predefined Filtering
- Customer Defined Filtering

Predefined Filtering Access Rule:

1. On the Side Navigation bar, click on [Firewall] then select [Access Control]
2. Under the Predefined Section, click on the [Add] button
3. On the Predefined Filter page, select the service that you want to block from the pull-down menu

Predefined Filter

Predefined filter allows users to choose the traffic type to be blocked from LAN site to the Internet.

Service	AIM/ICQ(TCP:5190)
LAN IPs	Any
Start IP	0 0 0 0
End IP	0 0 0 0

4. Select the [LAN IPs] that you want this access rule to apply to. You can choose to apply this rule to Any IP Address, a Single IP Address, or a Range of IP Addresses.
 - a. Any IP Address [Any] - choose this option to block all LAN clients. You don't need to configure the [Start IP] or [End IP] options.
 - b. Single IP Address [Single address] - choose this option to block a single LAN client. Enter the LAN IP address of the PC in the [Start IP] field.
 - c. IP Address Range [Address Range] - choose this option to block a range of LAN clients. Enter the starting LAN IP address in the [Start IP] field and the ending LAN IP address of the range you want in the [End IP] field.
5. When your configuration is complete, click the [Apply] button to save your changes and return to the main Access Control page.

Customer Defined Filtering Access Rule (Custom):

1. On the Side Navigation bar, click on [Firewall] then select [Access Control]
2. Under the Customer Defined Section, click on the [Add] button
3. On the Customer Defined Filter page, define a Name for the service/application that you want to block.

NOTE: The Name is only for reference purposes.

4. Then select the protocol type from the pull-down menu that they would like to block. The options are *TCP / UDP / TCP/UDP*.
5. Select the [LAN IPs] that you want this access rule to apply to. You can choose to apply this rule to Any IP Address, a Single IP Address, or a Range of IP Addresses.
 - a. Any IP Address [Any] - choose this option to block all LAN clients. You don't need to configure the [Start IP] or [End IP] options.
 - b. Single IP Address [Single address] - choose this option to block a single LAN client. Enter the LAN IP address of the PC in the [Start IP] field.
 - c. IP Address Range [Address Range] - choose this option to block a range of LAN clients. Enter the starting LAN IP address in the [Start IP] field and the ending LAN IP address of the range you want in the [End IP] field.
6. To complete the configuration enter in the [From Port] and [To Port] information will be blocked on the network.

NOTE: Usually every application has its own corresponding port number. Users should find out the correct port number from the application vendor. For example, if you are trying to block access to a Peer-2-Peer file sharing application then you should visit that applications web site to see the ports that application uses.

- When your configuration is complete, click the [Apply] button to save your changes and return to the main Access Control page.

Special Application

Some applications, such as Internet gaming, videoconferencing, Internet telephony, and others require multiple connections. Rules are based on the port or range of ports that the application sends data to the server on (destination port). When the Gateway sees traffic sent to the configured port(s), it dynamically allows all incoming traffic from the server on any port for the specified time.

To access the Special Application configuration page, on the Side Navigation bar, click on [Firewall] link and then click on the [Special Application] link.

To enable this option, click the [Enable Triggering] checkbox.

To configure a Special Application Rule, follow the steps outlined below:

- On the Side Navigation bar, click on [Firewall] then select [Special Application]
- Click on the [Add] button on the Special Application page to access the [Trigger] configuration section.

- Enter in the [Name] that you want to use for this rule.
- In the [Type] pull-down menu, select the data/traffic type that this rule will apply to. The options are *TCP / UDP*.
- Configure the [Port Number] that your application will be using as the outgoing trigger ports.

6. Set the [Interval] of the rule. This is the time in between the outgoing and incoming data traffic.

NOTE: If you set this value too low, the incoming ports will be closed before the return data arrives at the firewall and the connection will be broken and the application will not work.

7. The last 2 options are for Advanced Users, most users can leave this at the default settings:
 - IR Replacement - Default Setting: Disable address replacement
 - Allow sessions initiated from/to the 3rd host - Default Setting: unchecked
8. When your configuration is complete, click the [Apply] button to save your changes and return to the main Special Application page.

URL Blocking

This section allows you to control the content network. This feature is good for both business and parents looking to control the content accessible from a web browser.

To access the URL Blocking configuration page, on the Side Navigation bar, click on [Firewall] link and then click on the [URL Blocking] link.

To enable this option, click the [Enable Keyword Blocking] checkbox

URL Blocking

You can block access to certain Web sites from all internal PCs by entering either a full URL address or just a keyword of the Web site.
You also can specify a particular PC which will be exempted from the "URL Blocking" and allowed to have full access to all web sites.

Enable Keyword Blocking

Add exempted PC 0 . 0 . 0 . 0 . 0 . 0 **Add Trusted Host**

Exempted PC List (up to 10 hosts):

Delete **Clear All**

Keyword/Domain Name Type new Keyword/Domain here **Add Keyword**

Blocked Keyword/Domain Name List (up to 50 items):

Delete **Clear All**

To configure URL blocking, follow the steps outlined below:

1. On the Side Navigation bar, click on [Firewall] then select [URL Blocking]
2. Check the [Enable Keyword Blocking] checkbox to turn URL blocking on.

3. Enter in a new keyword or URL address that you want to block in the [Keyword/Domain Name] input box.
4. Press the [Add Keyword] button to save this keyword or URL.
5. The new keyword or URL address would be listed in the text box below.

NOTE: This list will support 50 Keywords or URLs.

If you want a PC on your network to bypass these rules you will need to set that PC as an Exempted PC/Trusted Host. To configure this option, check the [Add Trusted Host] option and enter the LAN IP address of the PC that you want to bypass the URL/Keyword blocking function with.

Schedule Rule

This feature will block Internet content based on the URL blocking function for PCs on your network based on the day and or time.

NOTE: The URL/Keyword blocking feature must be configured to use this schedule rule.

To access the Schedule Rule configuration page, on the Side Navigation bar, click on [Firewall] link and then click on the [Schedule Rule] link.

To enable this option, click the [Enable Schedule Function] checkbox.

Schedule Rule

This page defines the schedule rule you want to use with the "URL Blocking" page.

Week Day	
<input checked="" type="checkbox"/>	Every Day
<input checked="" type="checkbox"/>	Sunday
<input checked="" type="checkbox"/>	Monday
<input checked="" type="checkbox"/>	Tuesday
<input checked="" type="checkbox"/>	Wednesday
<input checked="" type="checkbox"/>	Thursday
<input checked="" type="checkbox"/>	Friday
<input checked="" type="checkbox"/>	Saturday

All Day

Start Time: 12 (hour) 0 (min) AM

End Time: 12 (hour) 0 (min) AM

HELP APPLY CANCEL

To configure Schedule Rules, follow the steps outlined below:

1. On the Side Navigation bar, click on [Firewall] then select [Schedule Rule]
2. In the [Week Day] table check the Days that you want to apply URL/Keyword Blocking.
3. Define the appropriate settings for a schedule rule.
4. Click the [OK] button to approve rule.
5. Then click the [APPLY] button to save your settings.

Email/Syslog Alert

The Gateway can provide network log and alert information to keep you updated. The Gateway can send an e-mail to as many as 4 users alerting them of an attempted intrusion or hacker attack. The Gateway also supports a Syslog Client so you can export your Network Log entries to a Syslog Server.

To access the Email/Syslog Alert configuration page, on the Side Navigation bar, click on [Firewall] link and then click on the [Email/Syslog Alert] link.

Email/Syslog Alert

When the firewall feature is enabled, The user can be notified about the blocked traffic by email and/or syslog.

The SMC8014WG firewall can notify the user about the intrusion and/or the attempts to access the blocked URL, also the notification could be sent out immediately or by the predefined time schedule.

Enable Email Alerting

Altering Email

SMTP Server Address

Sender's E-mail Address

Email Server Authentication

User Name

Password

Recipient list (up to 4 items)

Name	Email Address

Enable Syslog Alerting

Syslog Server Address

Alert Options

When intrusion is detected	<input type="checkbox"/>
When attempt to access blocked site	<input type="checkbox"/>

There are 3 sections to configure on this page:

- Email Alerting
- Syslog Alerting
- Alerting Schedule

To enable the Email Alert feature, click the [Enable Email Alerting] checkbox.

Follow the steps below to configure the Email Alert feature:

1. Enter in your SMTP Server Address (this is also referred to as the outgoing mail server)
2. Enter in the [Sender's E-mail Address] - this is the email address that is associated with the outgoing mail server account.
3. Enter in your email [User Name].
4. Enter in your email [Password].

NOTE: If you don't have your SMTP or outgoing mail server information, please contact your cable operator.

Enable Email Alerting

Altering Email

SMTP Server Address

Sender's E-mail Address

Email Server Authentication

User Name

Password

Recipient list (up to 4 items)

Name	Email Address

Add Edit Delete

- To add an email address to the Alert List, click the [Add] button. The configuration page shown below will be displayed:

Recipient Adding

Users could input and edit the email alert recipient list here.

Name

Recipient's Email Address

Back Apply Cancel

NOTE: The email alert feature will allow you to send email alerts to 4 different email accounts. For example you could send an email to your home, work, and school email address.

- Enter in the [Name] of the person/account that you want to send this to
- Enter in the [Recipient's Email Address] as the email address you want to send the alert to
- When complete, click the [Apply] button to save your settings and return to the main Email/Syslog Alert configuration page

If you need to edit or delete an existing email account, follow the steps below

- Check the radio button next to the email entry
- Click the [Edit] or [Delete] button.

Recipient list (up to 4 items)

	Name	Email Address
<input type="radio"/>	smc	email@smc.com

Add Edit Delete

To enable the Syslog Alert feature, click the [Enable Syslog Alerting] checkbox.

To configure the Syslog Server, enter the LAN IP of the [Syslog Server Address].

Enable Syslog Alerting

Syslog Server Address

Immediate Alerts can be generated for both the email and Syslog alerts. To configure the type of Alert that you want to get:

- An Intrusion is detected - this is a hacker attack attempt from the WAN
- Attempts to access a blocked site - alert to any attempts to access a site or keyword listed in your URL/Blocking list.

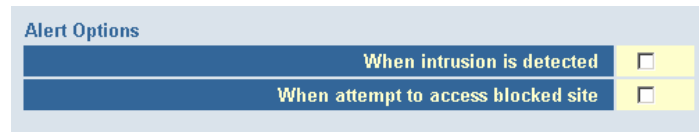

The image shows a configuration panel titled "Alert Options". It contains two rows, each with a label and a checkbox. The first row is "When intrusion is detected" with an unchecked checkbox. The second row is "When attempt to access blocked site" with an unchecked checkbox.

Alert Option	Enabled
When intrusion is detected	<input type="checkbox"/>
When attempt to access blocked site	<input type="checkbox"/>

DMZ Host (Demilitarized Zone)

If you have a client PC that cannot run an Internet application properly from behind the firewall, then you can open the client up to unrestricted two-way Internet access. Enter the IP address of a DMZ host to this screen. Adding a client to the DMZ (Demilitarized Zone) may expose your local network to a variety of security risks, so only use this option as a last resort.

To access the DMZ configuration page, on the Side Navigation bar, click on [Firewall] link and then click on the [DMZ] link.

To enable this option, click the [Enable DMZ Host] checkbox.

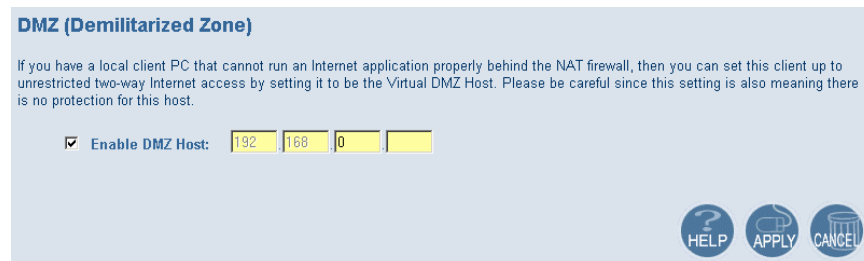

The image shows the "DMZ (Demilitarized Zone)" configuration page. It includes a warning message: "If you have a local client PC that cannot run an Internet application properly behind the NAT firewall, then you can set this client up to unrestricted two-way Internet access by setting it to be the Virtual DMZ Host. Please be careful since this setting is also meaning there is no protection for this host." Below the warning, there is a checkbox labeled "Enable DMZ Host:" which is checked. To the right of the checkbox are four input fields for the IP address, containing the values "192", "168", "0", and an empty field. At the bottom right, there are three circular buttons: "HELP", "APPLY", and "CANCEL".

To configure a DMZ host, Enter in the LAN IP Address of the PC on your network in the input fields.

TOOLS

The Tools menu allows a user to Backup the current configuration, Restore a previously saved configuration, Restore factory settings, and Reboot the Gateway. The Gateway configuration file is a clear text format.

Configuration Tools

From this section you can:

- Locally backup your Gateway's settings to a configuration file
- Remotely backup your Gateway's settings to a configuration file
- Restore settings from a local or remotely stored configuration file
- Restore the Gateway to Factory Defaults

To access the Configuration Tools configuration page, on the Side Navigation bar, click on [Tools] link and then click on the [Configuration Tools] link.

Configuration Tools

Use the "Backup" tool to save the SMC8014WG current configuration to a file named "smc.cfg" on your local PC. You can then use the "Restore" tool to restore the saved configuration to the SMC8014WG. Alternatively, if you want to backup or restore the SMC8014WG configuration remotely, you can use the "Remotely backup/restore Gateway settings" tool. To use this tool, you need to fill in the remote TFTP server address and Gateway config filename manually. Then press "Restore" button to retrieve the file from the TFTP server, or "Backup" to save the file to the TFTP server. Also, you can use the "Restore to Factory Defaults" tool to force the SMC8014WG to perform a power reset and restore the original factory settings.

- **Locally backup current settings**
- **Locally restore saved settings from file**
- **Remotely backup/restore Gateway settings**
- **Restore to Factory Defaults**

Locally Backup Settings to Configuration File

The first Tools option is to [Back Up] your configuration settings of your Gateway. This includes, but is not limited to, Port Forwarding, Special Application, and Alert Emails.

- **Locally backup current settings**

To save the Gateway settings to a configuration file, follow the steps below:

1. Click on the [Back Up] button
2. Click [Save] on the File Download dialog box
3. Save this file to a location on your network or local hard drive.

NOTE: You can rename the file as need, but you CANNOT change the file extension.

Locally Restore Settings from Configuration File

The second Tools option is used to restore the Gateway settings from the file that you backed up using the Back Up tool.

- **Locally restore saved settings from file**

To restore the Gateway settings from a configuration file, follow the steps below:

1. Click the [Browse] button to browse to the directory where you saved the backup file or type in the complete location (e.g. C:\backup\smc.cfg) in the input box
2. Click the [Restore] button to begin the process.

3. Click [OK] to confirm the restore process

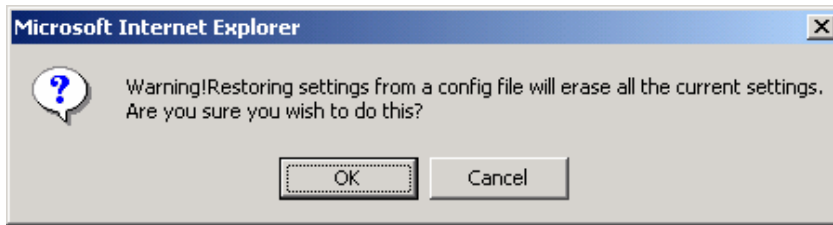

4. To complete the Restore process the Gateway will reboot.

NOTE: This file format (.cfg) is the only format that you can use to restore settings from. This is format that is provided by the Backup option.

Remotely Backup/Restore Gateway Settings

To backup your configuration settings of your Gateway to a TFTP server, select the [Backup] option.

A screenshot of a web interface titled "Remotely backup/restore Gateway settings". It contains two input fields: "TFTP Server Address" and "Gateway Config Filename". Below the fields are two buttons: "Restore" and "Backup".

To save the Gateway settings to a remotely stored configuration file, follow the steps below:

1. Enter the [TFTP Server Address]
2. Enter the [Gateway Config Filename]
3. Click on the [Backup] button

To restore the Gateway settings from a remotely stored configuration file, follow the steps below:

4. Enter the [TFTP Server Address]
5. Enter the [Gateway Config Filename]
6. Click on the [Restore] button

Restore EZ Connect™ Wireless Cable Modem Gateway to Default Settings.

The third Tools option is used to restore to Gateway to the default settings of the last software load.

A screenshot of a web interface titled "Restore to Factory Defaults". It contains a single button labeled "Factory Reset".

To restore your Gateway to Default Factory Settings, follow the steps below:

1. Click the [Factor Reset] button
2. Click [OK] on the confirmation dialog box

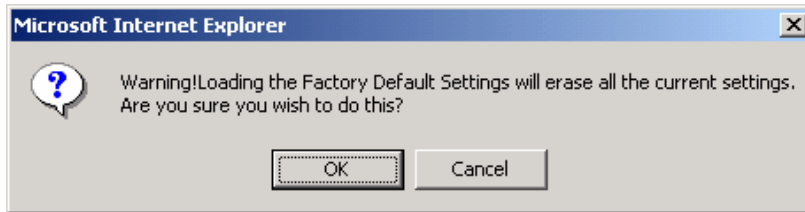

3. To complete the Restore process the Gateway will reboot.

Reboot

In the event that the system stops responding correctly or functioning properly, you can perform a reboot.

To access the Reboot option page, on the Side Navigation bar, click on [Tools] link and then click on the [Reboot] link.

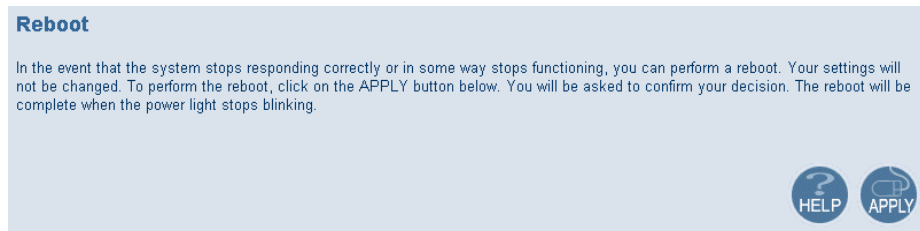

To reboot the Gateway, follow the steps below:

1. Click the [Apply] button
2. Click [OK] on the confirmation dialog box

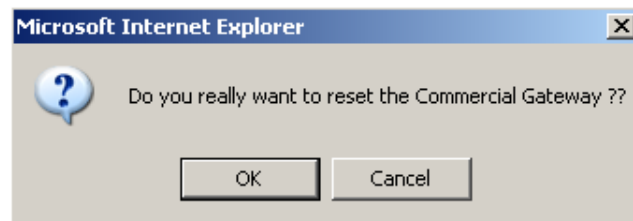

3. The Gateway will reboot.

NOTE: The Reboot will be complete when the power LED stops blinking.

Diagnostics

This section can be used to troubleshoot connection and setup issues. You can do the following:

- **Trace Route** - enter in the IP/Domain Name and click [tracert] to begin the trace from the Gateway.
- **Ping** - enter in the IP/Domain Name and click the [ping] button to begin the ping from the Gateway.
- **Send Inspected Traffic to Log Server** - enter in the IP Address of your log server and the amount of time you want to inspect and then click the [Apply] button. The Gateway will then capture all the data frames seen by the cable modem interface and send the results to the configured log server.

Diagnostics

In this page users can use tracer to trace the routing path to the destination, use ping to check if the destination is available, specify the log server and the sniffing time to record the upstream and downstream traffic.

- **Trace Route**
- **Ping**
- **Send inspected traffic to Log Server:**
 for secs

VPN

The VPN section allows you to setup VPN end points on the Gateway. By doing so, an encrypted tunnel will be established between the Gateway and the remote VPN end point.

To access the VPN configuration page, on the Side Navigation bar, click on [VPN] link.

VPN

If necessary, users can disable the VPN functions by checking the **Disable IPsec VPN Functions**, **Disable PPTP VPN Functions** and/or the **Disable L2TP VPN Functions** checkboxes.

- Disable IPsec VPN Functions**
- Disable PPTP VPN Functions**
- Disable L2TP over IPsec VPN Functions**

The Gateway supports 3 types of VPN termination:

- IPsec
- PPTP
- L2TP over IPsec

To enable a VPN end point protocol, deselect the appropriate option on the VPN settings page and click [Apply]. By default, all VPN end point options are disabled.

Create an IPsec VPN Tunnel

To enable and configure an IPsec end point, follow the steps below. Ensure that each end point is assigned a different LAN IP Subnet.

1. On the Side Navigation bar, click on the [VPN] link
2. On the VPN settings page, deselect the [Disable IPsec VPN Functions] option

VPN

If necessary, users can disable the VPN functions by checking the **Disable IPsec VPN Functions**, **Disable PPTP VPN Functions** and/or the **Disable L2TP VPN Functions** checkboxes.

- Disable IPsec VPN Functions**
- Disable PPTP VPN Functions**
- Disable L2TP over IPsec VPN Functions**

3. Click the [Apply] button to save your changes
4. On the Side Navigation bar, click on the [Access Control] link

Access Control

The SMC8014WG can allow the PC clients behind the gateway to access the Ipsec VPN tunnel.

Allow all PC clients behind the gateway to access IPsec VPN Tunnel

VPN Access List (up to 32 items)

#	MAC Address

Auto-Learned CPE Devices

	MAC Address
<input type="radio"/>	00:12:79:BD:88:A1

Manually-Added CPE Devices

MAC Address
<input type="text"/>

5. Enable LAN clients that will access the IPsec VPN by adding them to the VPN Access List. There are two ways to add a LAN client to the VPN Access List. Either select the radio button next to an [Auto-Learned CPE Device] or manually enter the LAN clients MAC address in the [Manually-Added CPE Devices] section, then select [Add]
6. On the Side Navigation bar, click on the [IPsec Tunnel Configuration] link

VPN - Tunnel Configuration

Tunnel Table (up to 15 items)

#	Remote IPsec ID	Remote Gateway IP	Status	Uptime & Count	Active Type

VPN Log

NOTE: There is a VPN Log on this page that displays VPN event messages.

7. Click on the [Add] button to configure the IPsec VPN

VPN - Adding VPN Tunnel

Local Host Setting/Intranet Configuration

Local ID

Intranet Address

Intranet Subnet Mask

Remote Gateway

Remote Gateway ID

Remote Gateway Address

Pre-shared Key

Key Management/IKE	
IKE Life Duration	<input type="text"/> (>IPSec Life Duration)
Authentication method	Preshared Key
IKE Hash	MD5
IKE Encryption	DES
IPSec	
IPSec Operation	ESP
ESP Transform	DES
ESP AUTH	NONE
AH	MD5
Tunnel Type	Public
IPSec Life Duration	<input type="text"/> (>= 60 sec)

- a. Either the Gateway's Private LAN IP address or Public LAN IP address can be configured as the end point for the VPN tunnel. Select either [Protect Private Lan] or [Protect Public Lan] to enable the entire Private or Public LAN to be part of the VPN tunnel and the respective Gateway LAN IP address will populate the [Intranet Address] and [Intranet Subnet Mask] fields.

Local Host Setting/Intranet Configuration	Protect Private Lan	Protect Public Lan
	<input type="checkbox"/>	<input type="checkbox"/>

- b. Enter the [Local ID] which must match the "Remote ID" of the remote VPN end point.

Local ID	<input type="text"/>
Intranet Address	<input type="text"/> . <input type="text"/> . <input type="text"/> . <input type="text"/>
Intranet Subnet Mask	<input type="text"/> . <input type="text"/> . <input type="text"/> . <input type="text"/>

- c. Enter the [Remote Gateway ID] which must match the "Local ID" of the remote VPN end point.

Remote Gateway	
Remote Gateway ID	<input type="text"/>
Remote Gateway Address	<input type="text"/> . <input type="text"/> . <input type="text"/> . <input type="text"/>
Pre-shared Key	<input type="text"/>

- d. Enter the [Remote Gateway Address]
 e. Enter the [Pre-shared Key] which must match the "Pre-shared Key" value of the remote VPN end point.
 f. Enter the [IKE Life Duration] value

Key Management/IKE	
IKE Life Duration	<input type="text"/> (>IPSec Life Duration)
Authentication method	Preshared Key
IKE Hash	MD5
IKE Encryption	DES

- g. Enter the [Authentication method]. Currently, the Gateway only supports [Preshared Key].
- h. Enter the [IKE HASH]. The options are *MD5 / SHA*.
- i. Enter the [IKE Encryption]. The options are *DES / IDEA / BLOWFISH / RC5 / 3DES*.
- j. Enter the [IPSec Operation]. The options are *ESP / AH*.

IPSec

IPSec Operation	ESP
ESP Transform	DES
ESP AUTH	NONE
AH	MD5
Tunnel Type	Public
IPSec Life Duration	<input type="text"/> (>= 60 sec)

- k. Enter the [ESP Transform]. The options are *DES / IDEA / BLOWFISH / RC5 / 3DES*. This option is only available when ESP [IPSec Operation] is selected.
- l. Enter the [ESP AUTH]. The options are *NONE / MD5 / SHA / DES*. This option is only available when ESP [IPSec Operation] is selected.
- m. Enter the [AH] encryption method. The options are *MD5 / SHA / DES*. This option is only available when AH [IPSec Operation] is selected.
- n. Enter the [Tunnel Type]. The options are *Public / Private*.
- o. Enter the [IPSec Life Duration] value.
- p. Configure the remote VPN end point LAN network address(es) in the Tunnel Host Remote Configuration section. Select either [IP Subnet] and enter the remote network address [IP Address] (e.g. 10.0.0.0) and [Subnet Mask] (e.g. 255.255.255.0) or select [IP Range] and enter [Starting IP] and [Ending IP].

Tunnel Remote Host Configuration

IP type : IP Subnet					
1	<table border="1"> <tr> <td>IP Address</td> <td>Subnet Mask</td> </tr> <tr> <td><input type="text"/></td> <td><input type="text"/></td> </tr> </table>	IP Address	Subnet Mask	<input type="text"/>	<input type="text"/>
IP Address	Subnet Mask				
<input type="text"/>	<input type="text"/>				
IP type : IP Subnet					
2	<table border="1"> <tr> <td>IP Address</td> <td>Subnet Mask</td> </tr> <tr> <td><input type="text"/></td> <td><input type="text"/></td> </tr> </table>	IP Address	Subnet Mask	<input type="text"/>	<input type="text"/>
IP Address	Subnet Mask				
<input type="text"/>	<input type="text"/>				
IP type : IP Subnet					
3	<table border="1"> <tr> <td>IP Address</td> <td>Subnet Mask</td> </tr> <tr> <td><input type="text"/></td> <td><input type="text"/></td> </tr> </table>	IP Address	Subnet Mask	<input type="text"/>	<input type="text"/>
IP Address	Subnet Mask				
<input type="text"/>	<input type="text"/>				
<input type="button" value="Back"/> <input type="button" value="Apply"/> <input type="button" value="Cancel"/>					

- q. Click [Apply] to save the configuration. You will be returned to the IPSec Tunnel Configuration page.
8. Establish the tunnel in the IPSec Tunnel Configuration page by: in the [Tunnel Table], under [Active Type], select [Negotiate] then [Apply].

VPN - Tunnel Configuration

Tunnel Table (up to 15 items)

#	Remote IPsec ID	Remote Gateway IP	Status	Uptime & Count	Active Type
1	test2	9.9.9.9	Broken	00h:00m:00s, 0	Negotiate

9. The [Status] should now be [Phase 2 Completed].

Create a PPTP VPN Tunnel

To enable and configure a PPTP server on the Gateway, follow the steps below. Note that remote PPTP clients that connect into the Gateway will be assigned IP addresses from the PPTP IP Address Pool on the LAN Settings page for their PPTP WAN interface.

1. On the Side Navigation bar, click on the [VPN] link
2. On the VPN settings page, deselect the [Disable PPTP VPN Functions] option

VPN

If necessary, users can disable the VPN functions by checking the **Disable IPsec VPN Functions**, **Disable PPTP VPN Functions** and/or the **Disable L2TP VPN Functions** checkboxes.

Disable IPsec VPN Functions
 Disable PPTP VPN Functions
 Disable L2TP over IPsec VPN Functions

3. Click the [Apply] button to save your changes
4. On the Side Navigation bar, click on the [PPTP/L2TP Configuration] link

VPN - PPTP/L2TP User Configuration

PPTP/L2TP User Table (up to 30 users)

#	Username	Password
<input type="button" value="Add"/> <input type="button" value="Edit"/> <input type="button" value="Delete"/>		

L2TP/IPsec Pre-Shared Phrase

Pre-Shared Phrase

5. Under the [PPTP/L2TP User Table] click the [Add] button.

Adding PPTP User

Set up the user account for PPTP/L2TP tunnel here.

User Name	<input type="text"/>
Password	<input type="password"/>

Back Apply Cancel

6. Enter the [User Name] and [Password]. User Name must be at least 3 characters and password must be at least 6 characters.
7. Click [Apply] to save the settings. You will be returned to the PPTP/L2TP Configuration page.

Create a L2TP over IPsec VPN Tunnel

To enable and configure a L2TP over IPsec end point, follow the steps below.

1. First, follow the steps to setup an IPsec tunnel in the Creating an IPsec VPN Tunnel section above.
2. On the VPN settings page, deselect the [Disable L2TP over IPsec VPN Functions] option and ensure the [Disable IPsec VPN Functions] option is also deselected.

VPN

If necessary, users can disable the VPN functions by checking the **Disable IPsec VPN Functions**, **Disable PPTP VPN Functions** and/or the **Disable L2TP VPN Functions** checkboxes.

Disable IPsec VPN Functions

Disable PPTP VPN Functions

Disable L2TP over IPsec VPN Functions

HELP APPLY CANCEL

3. Click the [Apply] button to save your changes
4. On the Side Navigation bar, click on the [PPTP/L2TP Configuration] link
5. Under the L2TP/IPsec Pre-Shared Phrase, enter the [Pre-Shared Phrase]

L2TP/IPsec Pre-Shared Phrase

Pre-Shared Phrase

6. Click [Apply] to save the settings.

STATUS

The Status screen summarizes important information about the Gateway including WAN/LAN connection status, Wireless settings, software version and hardware versions, and uptime statistics.

Status

You can use the Status screen to see the connection status for the SMC8014WG WAN/LAN interfaces, firmware and hardware version numbers, any illegal attempts to access your network, as well as information on all DHCP client PCs currently connected to your SMC8014WG.

RG Functions: Enabled

Current Time: SAT JAN 01 21:30:07 2005 **System Up Time:** 000 days 21h:30m:24s

INTERNET WAN IP: 0.0.0.0 WAN Subnet Mask: 0.0.0.0 WAN Gateway IP: 0.0.0.0 Primary DNS: 0.0.0.0 Secondary DNS: 0.0.0.0	GATEWAY DHCP Gateway IP Address: 192.168.0.1 Subnet Mask: 255.255.255.0 DNS Proxy IP Address: 192.168.0.1	INFORMATION Software Version: 4.01.04-TWC Hardware Version: 1A RF Cable MAC Address: 00:13:F7:05:40:82 USB MAC Address: 00:13:F7:05:40:83 Wireless MAC Address: 00:13:F7:05:40:84 RG WAN MAC Address: 00:13:F7:05:40:86 Serial Num: 5007054082
---	--	---

WIRELESS SSID: WLAN Encryption Type: WEP Encryption length: 128 Bits Encryption Pass Phrase: Channel Being Used: 1	Interfaces Uptime and Traffic Count LAN Uptime: 21h:30m:24s ,Receiving 341772 bytes , Sending 1223621bytes WAN Uptime: 21h:30m:24s ,Receiving 0 bytes ,Sending 0bytes
--	--

The Network Log shows both firewall and network activity

Network Log

View network activity and security logs.

```
(1/1/05 04:19:14) 192.168.0.35 mso logout  
(1/1/05 04:19:18) 192.168.0.35 mso login
```

Clear Refresh Send the Logs

The LAN Client Log shows the clients connected to the Gateway and the type of connection (Ethernet or Wireless). This also shows the IP address assigned to the client and the MAC Address of the client's network adapter.

LAN Client Log

View information on LAN clients currently linked to the SMC8014WG.

```
DHCP-IP:192.168.0.35, Device:cpersing, MAC:00:12:79:BD:88:A1, Interface:
```

Refresh IP Release

The Cable Modem System Event Log shows diagnostic information about your connection and cable system.

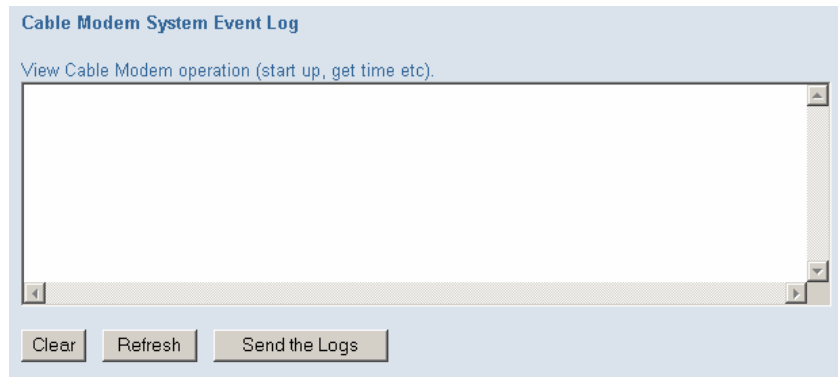

The Cable Status page shows the users the initialization process the SMC8014W-G has been through, and also includes the information about the downstream channel and the upstream channel the modem is connected on.

Cable Status

Cable status shows the users the cable initialization procedures, also the cable downstream and upstream status.

Initialization Procedure

Initialize Hardware	Success
Acquire Downstream Channel	Success
Upstream Ranging	Success
DHCP Bound	Success
Set Time-of-Day	Success
Downloading CM Config File	Success
Registration	Success

Traffic Enable!

Downstream Channel

Downstream Frequency	609000000 Hz
Lock Status	Locked
Modulation	64 QAM
Symbol Rate	5.056941 Msym/sec
Downstream Power	-2.2 dBmV
SNR	35.128 dB

Upstream Channel

Upstream Frequency	25000000 Hz
Lock Status	Locked
Modulation	QPSK
Symbol Rate	2560000 sym/sec
Upstream Power	48.2 dBmV
Channel ID	5

APPENDIX A | Telnet and SSH CLI Commands

Refer to the Remote Management section in Chapter 6 to enable and configure Telnet and SSH settings.

Refer to the 8014 CLI document for command specifics.

To remotely access the CLI of the SMC8014W-G via Telnet, open a DOS/Command Prompt and type: telnet IP remote mgmt port *Enter*

- **NOTE:** Telnet remote management is not enabled by default. To enable, first log into the Gateway via the HTTP web admin page and go to System/Remote Management and select the check box next to Telnet Port
- For example, open a command prompt and type: telnet xxx.xxx.xxx.xxx 2323 *Enter* (where xxx.xxx.xxx.xxx is your WAN IP listed on the status page)
- Enter the same user and password as used for the GUI/HTTP
- Commands are case sensitive
- Type *help* and then *Enter* for a list of commands

Use an SSH client of your choice for SSH remote management.

APPENDIX B | Troubleshooting

This appendix describes common problems you may encounter and possible solutions to them.

B.1 | Verify you are connected to the EZ Connect™ Wireless Cable Modem Gateway

If you are unable to access the Gateway's web-based administration pages, then you may not be properly connected or configured. The screen shots in this section were taken on a Windows 2000 machine, but the same steps will apply to Windows 95/98/Me/XP.

To determine your TCP/IP configuration status, please follow the steps below:

1. Click [Start] then choose [Run]
2. Type "cmd" or "command" (without the quotes) to open a DOS prompt.
3. In the DOS window, type "ipconfig" and verify the information that is displayed.
4. If your computer is setup for DHCP, then your TCP/IP configuration should be similar to the information displayed:
 - IP Address: 192.168.0.X (x is number between 100 and 199)
 - Subnet: 255.255.255.0
 - Gateway: 192.168.0.1



```
C:\WINDOWS\system32\command.com
Microsoft(R) Windows DOS
(C) Copyright Microsoft Corp 1990-2001.
C:\DOCUMENTS\CPERSI~1.SMC>ipconfig

Windows IP Configuration

Ethernet adapter Local Area Connection:

    Connection-specific DNS Suffix  . : mygateway.net
    IP Address. . . . .               : 192.168.0.35
    Subnet Mask . . . . .             : 255.255.255.0
    Default Gateway . . . . .         : 192.168.0.1

Ethernet adapter Wireless Network Connection:

    Media State . . . . .             : Media disconnected

C:\DOCUMENTS\CPERSI~1.SMC>
```

If you have an IP address that starts with 169.254.XXX.XXX then see section A.2.

If you have another IP address configured, see section A.3.

B.2 | I am getting an IP Address that starts with 169.254.XXX.XXX

If you are getting this IP Address, then you need to check that you are properly connected to the EZ Connect™ Wireless Cable Modem Gateway.

Confirm that you have a good link light on the Gateway's port to which this computer is connected. If not, please try another cable.

If you have a good link light, please open up a DOS window as described in section A.1 and type "ipconfig /renew" (without the quotes)

If you are still unable to get an IP Address from the Gateway, reinstall your network adapter. If anti-virus software is running on your computer, disable it before reinstalling the network adapter. Please refer to your adapter manual for instructions.

B.3 | I have another IP Address displayed

If you have another IP address listed, then the PC may not be configured for a DHCP connection. Please refer to [Chapter 4 | Configure your Computer](#) for information.

Once you have confirmed your computer is configured for DHCP, follow the steps below.

1. Open a DOS window as described above.
2. Type "ipconfig /release" (without the quotes)



```
C:\WINDOWS\system32\command.com
Microsoft(R) Windows DOS
(C) Copyright Microsoft Corp 1990-2001.

C:\DOCUME~1\CPERSI~1.SMC>ipconfig /release

Windows IP Configuration

No operation can be performed on Wireless Network Connection while it has its me
dia disconnected.

Ethernet adapter Local Area Connection:

    Connection-specific DNS Suffix  . :
    IP Address. . . . . : 0.0.0.0
    Subnet Mask . . . . . : 0.0.0.0
    Default Gateway . . . . . :

Ethernet adapter Wireless Network Connection:

    Media State . . . . . : Media disconnected

C:\DOCUME~1\CPERSI~1.SMC>_
```

3. Then type "ipconfig /renew" (without the quotes)

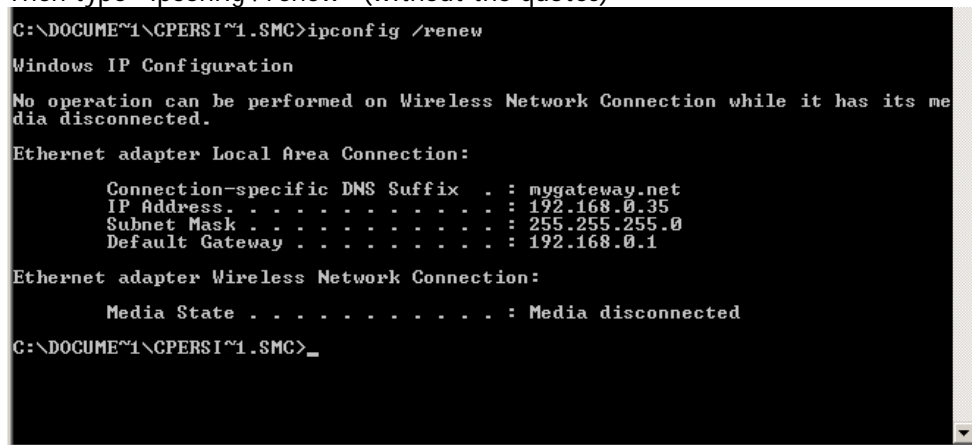

```
C:\WINDOWS\system32\command.com
Microsoft(R) Windows DOS
(C) Copyright Microsoft Corp 1990-2001.

C:\DOCUME~1\CPERSI~1.SMC>ipconfig /renew

Windows IP Configuration

No operation can be performed on Wireless Network Connection while it has its me
dia disconnected.

Ethernet adapter Local Area Connection:

    Connection-specific DNS Suffix  . : mygateway.net
    IP Address. . . . . : 192.168.0.35
    Subnet Mask . . . . . : 255.255.255.0
    Default Gateway . . . . . : 192.168.0.1

Ethernet adapter Wireless Network Connection:

    Media State . . . . . : Media disconnected

C:\DOCUME~1\CPERSI~1.SMC>_
```

Once you are able to get a valid IP address from the Gateway, you can now access the web-based Administration pages.

If you still are not getting an IP address from the Gateway, please reset the hardware as outlined in [Chapter 2](#) and follow the steps outlined in this appendix again. Note: all configured settings will be erased.

If you still cannot access the Gateway once you have reset it, please contact your cable operator for assistance.

B.4 | Pinging the EZ Connect™ Wireless Cable Modem Gateway

To verifying Your TCP/IP Connection is configured properly and you are able to access the EZ Connect™ Wireless Cable Modem Gateway's web-based management screens - you can use the 'Ping' command in DOS. To access the DOS dialog window please follow the steps below:

1. Click Start, then choose Run
2. Windows 98/Me users type "command" and click the [OK] button.
Windows 2000/XP users type "cmd" and click the [OK] button.
3. At the prompt, type: ping 10.1.10.1
After you click [enter] to execute the PING command you will get some information back, below is an outline of the possible return messages:

Good Connection

```
C:\>ping 192.168.0.1

Pinging 192.168.0.1 with 32 bytes of data:

Reply from 192.168.0.1: bytes=32 time<1ms TTL=64
Reply from 192.168.0.1: bytes=32 time=48ms TTL=64
Reply from 192.168.0.1: bytes=32 time<1ms TTL=64
Reply from 192.168.0.1: bytes=32 time<1ms TTL=64

Ping statistics for 192.168.0.1:
    Packets: Sent = 4, Received = 4, Lost = 0 (0% loss),
    Approximate round trip times in milli-seconds:
        Minimum = 0ms, Maximum = 48ms, Average = 12ms
```

Bad Connection

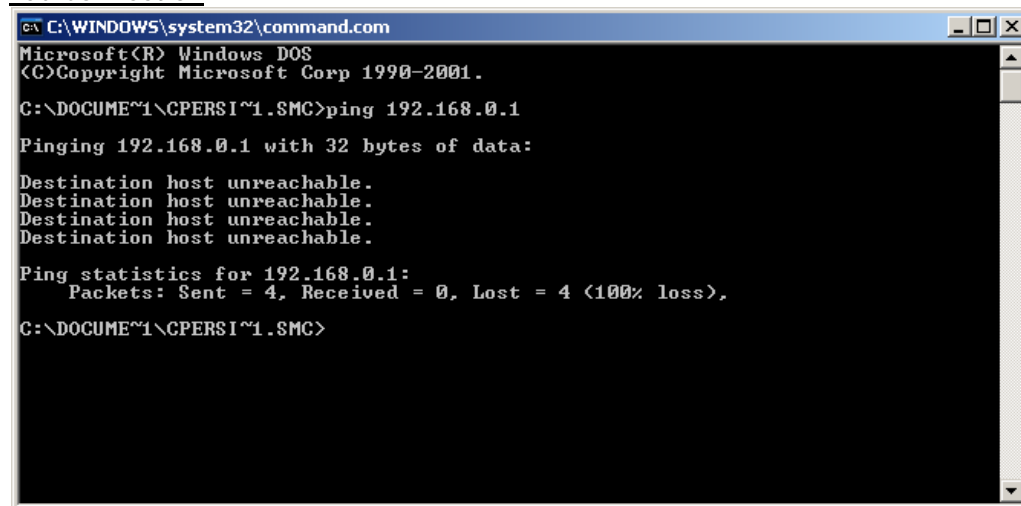
A screenshot of a DOS command window titled "C:\WINDOWS\system32\command.com". The window shows the execution of a ping command to 192.168.0.1. The output indicates a "Bad Connection" as all four packets sent were lost, resulting in a 100% loss. The window title bar includes standard Windows window controls (minimize, maximize, close).

```
ca C:\WINDOWS\system32\command.com
Microsoft(R) Windows DOS
(C)Copyright Microsoft Corp 1990-2001.

C:\DOCUME~1\CPERSI~1.SMC>ping 192.168.0.1

Pinging 192.168.0.1 with 32 bytes of data:

Destination host unreachable.
Destination host unreachable.
Destination host unreachable.
Destination host unreachable.

Ping statistics for 192.168.0.1:
    Packets: Sent = 4, Received = 0, Lost = 4 (100% loss),

C:\DOCUME~1\CPERSI~1.SMC>
```

There may be something wrong in your installation procedure. Check the following items in sequence:

1. Is the Ethernet cable correctly connected between the Gateway and the computer?
2. The LAN LED on the Gateway and the Link LED of the network card on your computer must be on.
3. Is TCP/IP properly configured on your computer?

B.5 | Symptom / Action Troubleshooting

The Gateway can be easily monitored through panel indicators to identify problems. Please refer to Chapter 2 - Section 2.0 | LED Definitions to confirm you have the correct LED status. If not, then refer to the symptoms and actions outlined below:

SYMPTOM: Power LED is Off

ACTION:

- Check connections between the Gateway, the external power supply, and the wall outlet.
- If the power indicator does not light when the power cord is plugged in, you may have a problem with the power outlet, power cord, or external power supply.
- If the unit powers off after running for a while, check for loose power connections, power losses, or surges at the power outlet.
- If you cannot isolate the problem, then the external power supply may be defective. In this case, contact your cable operator for assistance.

SYMPTOM: Diag LED is On

ACTION:

- Power Cycle the Gateway. Unplug the Gateway - wait 5 seconds - plug it back into power.
- If the Diag LED is still on, reset the hardware as outlined in Chapter 2 and power cycle the Gateway again.
- If this does not resolve your problem, contact your cable operator for assistance.

SYMPTOM: Cable LED is Off or Flashing

ACTION:

- Power Cycle the Gateway. Unplug the Gateway - wait 5 seconds - plug it back into power.
- Confirm your cable operator is not having network issues and the network is up and running.
- If you cannot isolate the problem contact your cable operator for assistance.

SYMPTOM: Wireless LED is Off

ACTION:

- Check to insure the wireless card in the back panel is firmly plugged into the card slot. If not, unplug Gateway and put the wireless card firmly into the PC Card slot.
- Confirm wireless option is enabled in the web-management
- Reboot the Gateway.
- If you cannot isolate the problem contact your cable operator for assistance.

SYMPTOM: Cannot connect using the web browser

ACTION:

- Confirm that you are using a Java-supported browser such as Internet Explorer 5.0 or above, or Netscape Navigator 5.0 or above.
- Disable any firewall or security software that may be running on your PC.
- You will also need to verify that the "HTTP Proxy" feature of your web browser is disabled. Refer to Chapter 5 | Configuring the EZ Connect™ Wireless Cable Modem Gateway for more information.
- Check that you have a valid network connection to the Gateway.
- Check the network cabling between the management station and the Gateway.

SYMPTOM: Forgot or lost the password

ACTION:

- Contact your cable operator for assistance.

SYMPTOM: Internet users can not access my service/server hosted on a LAN computer

ACTION:

- Configure a Port Forwarding rule as described in the **NAT section of CHAPTER 6**.
- Contact your cable operator for assistance if you do not have this option available in your login.

SYMPTOM: My Gateway is wireless enabled and I can not connect to the wireless network

ACTION:

- Confirm that your computer's wireless adapter is configured with the same SSID and encryption (if enabled) of the Gateway. Refer to the **Wireless section of CHAPTER 6**.
- If Wireless MAC Filtering is enabled (Trusted PCs only), ensure that the wireless computer's MAC Address has been added to the Wireless Access List.
- Contact your cable operator for assistance if you do not have these options available in your login.

SYMPTOM: My VPN, VoIP, multimedia, or other application is not working

ACTION:

- Configure a Special Application rule as described in the **Firewall section of CHAPTER 6**.
- Confirm that an Access Control (Port Filtering) rule is not blocking the ports used by the application. Refer to the **Firewall section of CHAPTER 6**.
- Contact your cable operator for assistance if you do not have this option available in your login.

APPENDIX C | Technical Specifications

Standards

- 802.3 10BaseT Ethernet
- 802.3u 100BaseTX Fast Ethernet
- 802.11g

WAN Interface

- F-type RF Connector

LAN Interfaces

- 4 - 10BASE-T/100BASE-TX RJ-45 ports
- 1 - USB 1.1 Type B Connector
- 1 - 801.11g Access Point

Wireless Interface

- 54Mbps IEEE 802.11g Wireless LAN
- WPA encryption
- 64/128 bit WEP encryption
- Auto data rate of: 54, 48, 36, 24, 18, 12, 9, 6 Mbps (802.11g) and 11, 5.5, 2, and 1 Mbps (802.11b)

Cable Modem Interface

- DOCSIS 1.1 and 2.0 RFI compliant
- 64/256QAM auto detection
- Supports maximum DOCSIS transfer rates
- Independent resets for downstream and upstream blocks
- Fragmentation and concatenation enabling

Networking

- IEEE 802.1d compliant bridging
- DHCP Client and Server
- DNS Relay
- ICMP, FTP/TFTP, and Telnet

Security

- Password protected configuration access
- Stateful Packet Inspection (SPI) Firewall
- Network Address Translation (NAT)
- Application Level Gateways (ALG)
- WPA and WEP encryption
- Wireless MAC filtering
- Disable SSID Broadcast
- Intrusion Detection logging
- Denial of Service (DoS) prevention
- Email Alerts

Management

- Browser-based management

Indicator Panel

- Power - Green
- Diagnostics - Green
- Cable - Green
- Traffic - Green
- WLAN - Green
- LAN (1-4) (10Mbps - Amber / 100 Mbps - Green)
- USB - Green

Dimensions

- 10.5" x 8" x 1.64"

Weight

- 1.35lbs

Input Power

- 12V/1.25A

Operating Environment

- Operating Temp. 0C to 40C (32F to 104F)
- Storage Temp. -20C to 70C (-4F to 158F)

Humidity

- 5% to 85% (non-condensing)

Compliances

- FCC Part 15B Class B
- FCC Part 68
- CD mark EN55024
- FCC Part 15C Class B
- CE Class B
- VCCI Class B
- CSA International
- UL

Warranty

- One-year

APPENDIX D | Compliances

FCC Interference Statement

This equipment has been tested and found to comply with the limits for a Class B digital device pursuant to Part 15 of the FCC Rules. These limits are designed to provide reasonable protection against radio interference in a commercial environment. This equipment can generate, use and radiate radio frequency energy and, if not installed and used in accordance with the instructions in this manual, may cause harmful interference to radio communications. Operation of this equipment in a residential area is likely to cause interference, in which case the user, at his own expense, will be required to take whatever measures are necessary to correct the interference.

CE Declaration of Conformity

This equipment complies with the requirements relating to electromagnetic compatibility, EN 55022/A1 Class B, and EN 50082-1. This meets the essential protection requirements of the European Council Directive 89/336/EEC on the approximation of the laws of the member states relation to electromagnetic compatibility.

Compliances

APPENDIX E | Technical Support

At this time, the SMC8014W-G is only distributed through cable operators. Contact your cable operator with any technical support needs you may have.

PHONE

From U.S.A. and Canada (24 hours a day, 7 days a week)

- (800) SMC-4-YOU
- (949) 679-8000
- Fax: (949) 679-1481

From Europe (8:00 AM - 5:30 PM UK Time)

- 44 (0) 118 974 8700
- Fax: 44 (0) 118 974 8701

INTERNET

E-mail addresses:

- techsupport@smc.com
- european.techsupport@smc-europe.com

Driver updates:

- http://www.smc.com/index.cfm?action=tech_support_drivers_downloads

World Wide Web:

- <http://www.smc.com/>
- <http://www.smc-europe.com/>

SMC Networks, Inc.
38 Tesla
Irvine, CA
92618

Rev. 1.0 – 4.01.05-TWC

Downloaded from www.Manualslib.com manuals search engine

SMC8014W-G