

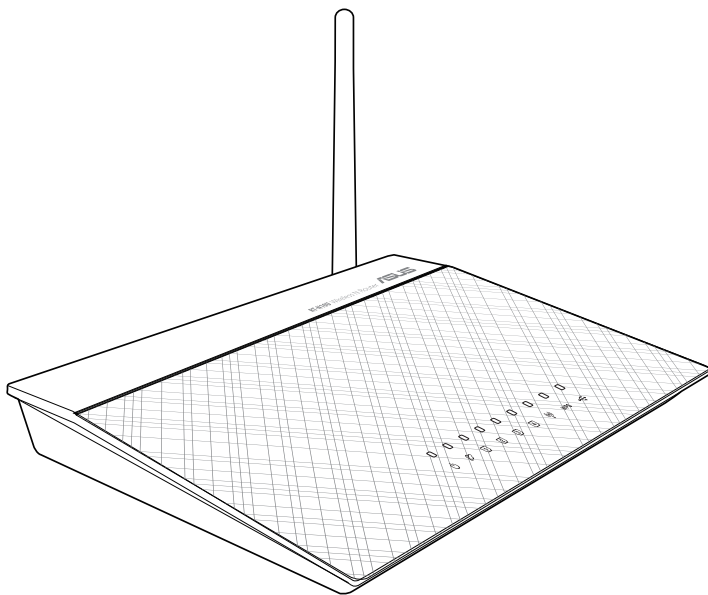

ASUS[®]

RT-N10U

Wireless - N150 Router



User Manual



E7656
Second Edition
August 2012

Copyright © 2012 ASUSTeK Computer Inc. All Rights Reserved.

No part of this manual, including the products and software described in it, may be reproduced, transmitted, transcribed, stored in a retrieval system, or translated into any language in any form or by any means, except documentation kept by the purchaser for backup purposes, without the express written permission of ASUSTeK Computer Inc. ("ASUS").

Product warranty or service will not be extended if: (1) the product is repaired, modified or altered, unless such repair, modification or alteration is authorized in writing by ASUS; or (2) the serial number of the product is defaced or missing.

ASUS PROVIDES THIS MANUAL "AS IS" WITHOUT WARRANTY OF ANY KIND, EITHER EXPRESS OR IMPLIED, INCLUDING BUT NOT LIMITED TO THE IMPLIED WARRANTIES OR CONDITIONS OF MERCHANTABILITY OR FITNESS FOR A PARTICULAR PURPOSE. IN NO EVENT SHALL ASUS, ITS DIRECTORS, OFFICERS, EMPLOYEES OR AGENTS BE LIABLE FOR ANY INDIRECT, SPECIAL, INCIDENTAL, OR CONSEQUENTIAL DAMAGES (INCLUDING DAMAGES FOR LOSS OF PROFITS, LOSS OF BUSINESS, LOSS OF USE OR DATA, INTERRUPTION OF BUSINESS AND THE LIKE), EVEN IF ASUS HAS BEEN ADVISED OF THE POSSIBILITY OF SUCH DAMAGES ARISING FROM ANY DEFECT OR ERROR IN THIS MANUAL OR PRODUCT.

SPECIFICATIONS AND INFORMATION CONTAINED IN THIS MANUAL ARE FURNISHED FOR INFORMATIONAL USE ONLY, AND ARE SUBJECT TO CHANGE AT ANY TIME WITHOUT NOTICE, AND SHOULD NOT BE CONSTRUED AS A COMMITMENT BY ASUS. ASUS ASSUMES NO RESPONSIBILITY OR LIABILITY FOR ANY ERRORS OR INACCURACIES THAT MAY APPEAR IN THIS MANUAL, INCLUDING THE PRODUCTS AND SOFTWARE DESCRIBED IN IT.

Products and corporate names appearing in this manual may or may not be registered trademarks or copyrights of their respective companies, and are used only for identification or explanation and to the owners' benefit, without intent to infringe.

Offer to Provide Source Code of Certain Software

This product contains copyrighted software that is licensed under the General Public License ("GPL"), under the Lesser General Public License Version ("LGPL") and/or other Free Open Source Software Licenses. Such software in this product is distributed without any warranty to the extent permitted by the applicable law. Copies of these licenses are included in this product.

Where the applicable license entitles you to the source code of such software and/or other additional data, such data should have been shipped along with this product.

You may also download it for free from <http://support.asus.com/download>.

The source code is distributed WITHOUT ANY WARRANTY and licensed under the same license as the corresponding binary/object code.

ASUSTeK is eager to duly provide complete source code as required under various Free Open Source Software licenses. If however you encounter any problems in obtaining the full corresponding source code we would be much obliged if you give us a notification to the email address gpl@asus.com, stating the product and describing the problem (please do NOT send large attachments such as source code archives etc to this email address).



Table of contents

About this guide	5
Package contents	7
System requirements	7
Getting to know your wireless router	
Before you proceed	8
Hardware features	9
Top panel.....	9
Rear panel.....	10
Bottom panel.....	11
Mounting options	12
Setting up your wireless network	
Setting up the wireless router	13
Using the Quick Internet Setup (QIS)	13
Using QIS with auto-detection.....	13
Configuring the network clients	
Accessing the wireless router	17
Setting an IP address for wired or wireless clients.....	17
Configuration via the web GUI	23
Network configuration using the web GUI	
Using the Network Map	24
Creating your Guest Network	26
Using the Traffic Manager	28
Managing QoS (Quality of Service) Bandwidth.....	28
Monitoring Traffic.....	30
Administration - Operation Mode	31
Router Mode	31
Repeater Mode	32
AP (Access Point) Mode	33





Table of contents

- Using 3G/4G Sharing Mode 34**
- Setting up the DHCP Server 36**
- Upgrading the firmware 37**
- Restoring/Saving/Uploading settings 38**
- Using the USB Extension..... 39**
 - Using AiDisk for File Sharing..... 40
 - Using the Network Place (Samba) Share service 42
 - Using the FTP Share service 44
 - Using the Miscellaneous setting..... 47
- Using the utilities**
 - Installing the utilities 49**
 - Device Discovery 51**
 - Firmware Restoration..... 52**
 - Setting up your network printer 53**
- Troubleshooting**
 - Troubleshooting..... 57**
 - ASUS DDNS Service..... 60**
 - Frequently Asked Questions (FAQs)..... 60
- Appendices**
 - Notices..... 63**
 - ASUS Contact Information..... 71**





About this guide

This user guide contains information that you need to install and configure the ASUS Wireless Router.

How this guide is organized

This guide contains the following parts:

- **Chapter 1: Getting to know your wireless router**

This chapter provides information on the package contents, system requirements, hardware features, and LED indicators of the ASUS Wireless Router.

- **Chapter 2: Setting up your wireless network**

This chapter provides instructions on setting up the Router and Access Point modes of the ASUS Wireless Router.

- **Chapter 3: Configuring the network clients**

This chapter provides instructions on setting up the clients in your network to work with your ASUS Wireless Router.

- **Chapter 4: Network configuration using the web GUI**

This chapter provides instructions on configuring the ASUS Wireless Router using its web graphics user interface (web GUI).

- **Chapter 5: Using the utilities**

This chapter provides information on the utilities that are available from the support CD.

- **Chapter 6: Troubleshooting**

This chapter provides you with a troubleshooting guide for solving common problems you may encounter when using the ASUS Wireless Router.

- **Appendices**

This chapter provides you with the regulatory Notices and Safety Statements.





Conventions used in this guide

To ensure that you perform certain tasks properly, take note of the following symbols used throughout this manual.



DANGER/WARNING: Information to prevent injury to yourself when completing a task.



CAUTION: Information to prevent damage to the components when completing a task.



IMPORTANT: Instructions that you **MUST** follow to complete a task.



NOTE: Tips and additional information to help you complete a task.





Getting to know your wireless router

1

Package contents

Check the following items in your ASUS Wireless Router package.

- RT-N10U Wireless Router x1
- Power adapter x1
- Support CD x1
- RJ-45 cable x1
- USB cable x1
- Quick Start Guide x1
- Warranty card x1



If any of the items is damaged or missing, contact your retailer.

System requirements

Before installing the ASUS Wireless Router, ensure that your system/network meets the following requirements:

- An Ethernet RJ-45 port (10Base-T/100Base-TX)
- At least one IEEE 802.11b/g/n device with wireless capability
- An installed TCP/IP and Internet browser





Before you proceed

Take note of the following guidelines before installing the ASUS Wireless Router:

- The length of the Ethernet cable that connects the device to the network (hub, ADSL/cable modem, router, wall patch) must not exceed 100 meters.
- Place the device on a flat and stable surface as far from the ground as possible.
- Keep the device clear from metal obstructions and away from direct sunlight.
- Keep the device away from transformers, heavy-duty motors, fluorescent lights, microwave ovens, refrigerators, and other industrial equipment to prevent signal loss.
- Place the device at the center of the network to provide ideal coverage for all wireless mobile devices.
- Install the device at least 20cm away from the user in accordance with the RF Guidelines for Human Exposure adopted by the Federal Communications Commission.







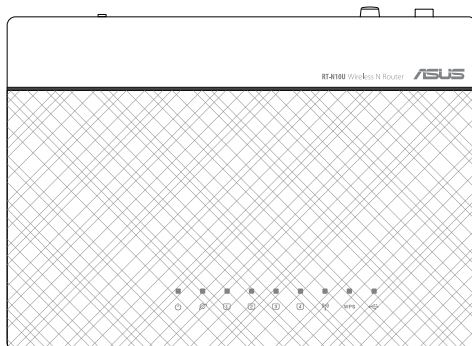



Hardware features

Top panel



Status indicators

LED	Status	Indication
	Off	No power
	On	System ready
	Flashing	Rescue mode
	Off	No power or no physical connection
	On	Has physical connection to an Ethernet network
	Flashing	Transmitting or receiving data (through Ethernet cable)
   	Off	No power or no physical connection
	On	Has physical connection to an Ethernet network
	Flashing	Transmitting or receiving data (through Ethernet cable)
	Off	No power
	On	Wireless system ready
	Flashing	Transmitting or receiving data (wireless)
WPS	Flashing	WPS processing
	Off	No power or no physical connection
	On	External USB device installed.

Rear panel

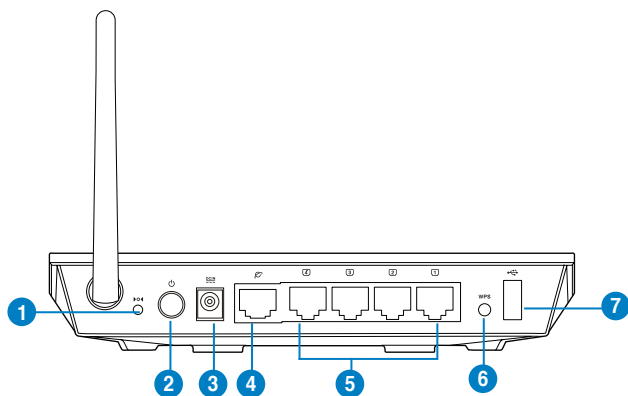

Item	Description
1	Reset button Press this button for more than five seconds to reset the system to its factory default settings.
2	Power switch Press this button to turn the power on/off.
3	Power (DC-In) port Insert the AC adapter into this port to connect your router to a power source.
4	WAN port Connect an RJ-45 Ethernet cable to this port to establish WAN connection.
5	LAN 1 ~ 4 ports Connect RJ-45 Ethernet cables to these ports to establish LAN connection.
6	WPS button Press this button to establish wireless connection.
7	USB 2.0 port Insert a USB device into this port.



Bottom panel

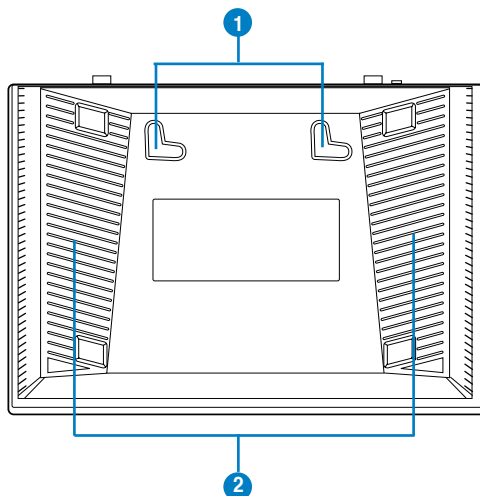

Item	Description
1	Mounting hooks Use the mounting hooks to mount your router on concrete or wooden surfaces using two round head screws.
2	Air vents These vents provide ventilation to your router.



For details on mounting your router on a wall or ceiling, refer to the section **Mounting options**.





Mounting options

The ASUS Router is designed to sit on a raised flat surface like a file cabinet or book shelf. The unit may also be mounted to a wall or ceiling.

To mount the ASUS Router:

1. Look for the two mounting hooks underneath the router.
2. Mark two upper holes on a flat surface.
3. Screw on two round head screws on the surface until only 1/4" is showing.
4. Latch the hooks of the ASUS Router onto the screws.

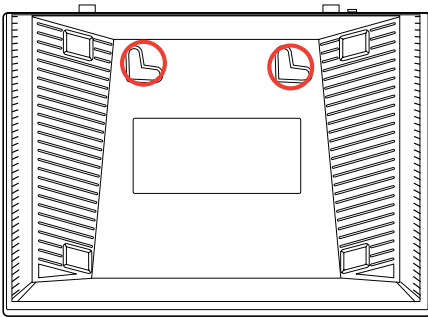

Re-adjust the screws if you cannot latch the ASUS Wireless Router onto the screws or if the fit is too loose.



2

Setting up your wireless network

Setting up the wireless router

The ASUS Wireless Router includes a web graphical user interface (web GUI) that allows you to configure the wireless router using your web browser.



For details on configuring your wireless router using the web GUI, refer to **Chapter 4: Network configuration using the web GUI**.

Using the Quick Internet Setup (QIS)

Using QIS with auto-detection

The Quick Internet Setup (QIS) feature guides you in quickly setting up your Internet connection.

To use QIS with auto-detection:

1. Launch a web browser such as Internet Explorer, Mozilla Firefox, Safari, or Google Chrome. Manually key in the wireless router's default IP address: `http://192.168.1.1`

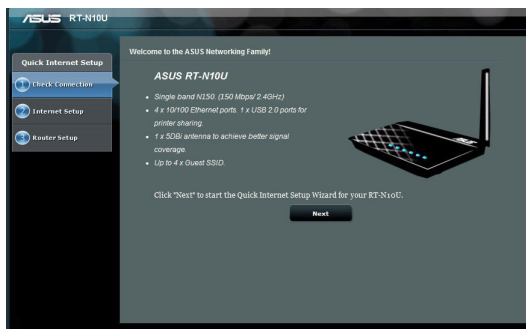

2. Use the default username (**admin**) and password (**admin**) to log into the user interface.

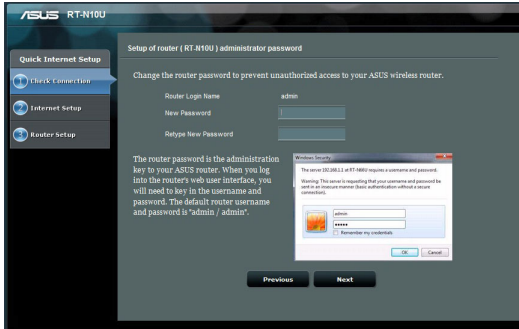

3. The wireless router automatically detects if your ISP connection type is **Dynamic IP, PPPoE, PPTP, L2TP, and Static IP**. Key in the necessary information for your ISP connection type.

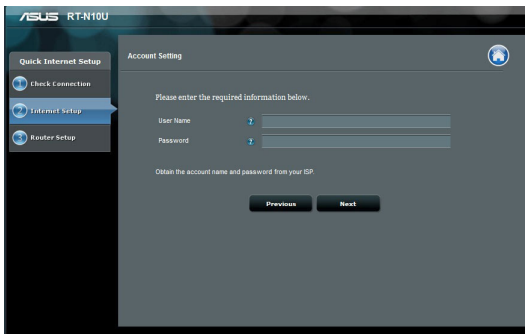

- Assign the **network name (SSID)** and **network key** for a secure wireless network. Click **Apply** when done.

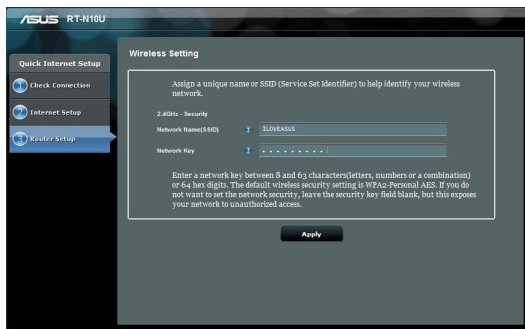

- A summary of your Internet and wireless settings will be displayed. Click **Next** to continue.

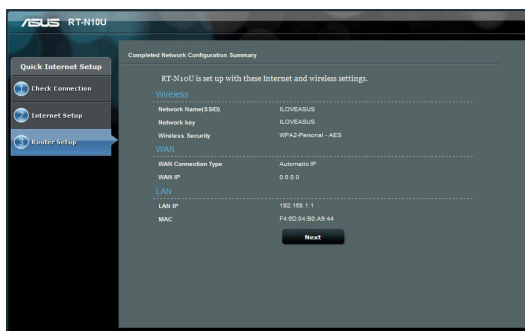

6. Read the wireless network connection tutorial. Click **Finish**.

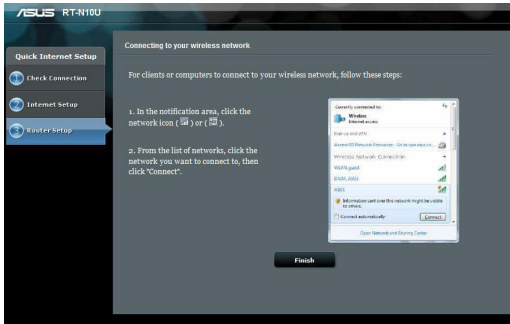



3 Configuring the network clients

Accessing the wireless router

Setting an IP address for wired or wireless clients

To access the ASUS Wireless Router, you must have the correct TCP/IP settings on your wired or wireless clients. Ensure that the clients' IP addresses are within the same subnet as the ASUS Wireless Router.

By default, the ASUS Wireless Router uses DHCP to automatically assign IP addresses to the clients in your network.

You may, however, want to manually assign static IP addresses on some of the clients or computers in your network rather than automatically getting IP addresses from your wireless router.

Follow the instructions below that correspond to the operating system installed on your client or computer.



In the Router mode, if you want to manually assign an IP address to your client, we recommend that you use the following settings:

- **IP address:** 192.168.1.xxx (xxx can be any number between 2 and 254. The IP address should not be used by another device)
 - **Subnet Mask:** 255.255.255.0 (same as the ASUS Wireless Router)
 - **Gateway:** 192.168.1.1 (IP address of the ASUS Wireless Router)
 - **DNS:** 192.168.1.1 (ASUS Wireless Router) or assign a known DNS server in your network
-



Windows® 2000

1. Click **Start > Control Panel > Network and Dial-up Connection**. Right-click **Local Area Connection** then click **Properties**.

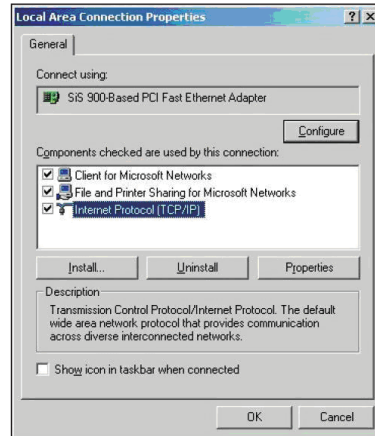

2. Select **Internet Protocol (TCP/IP)**, then click **Properties**.
3. Select **Obtain an IP address automatically** if you want the IP settings to be assigned automatically. Otherwise, select **Use the following IP address**. Key in an **IP address**, **Subnet mask**, and **Default gateway**.
4. Select **Obtain DNS server address automatically** if you want the DNS server settings to be assigned automatically. Otherwise, select **Use the following DNS server addresses**: and key in the **Preferred DNS server** and **Alternate DNS server**.
5. Click **OK**.

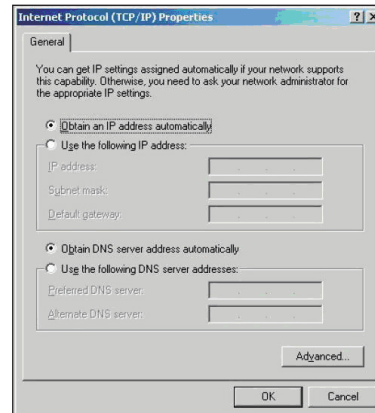

Windows® XP

1. Click **Start > Control Panel > Network Connection**. Right-click **Local Area Connection** then select **Properties**.

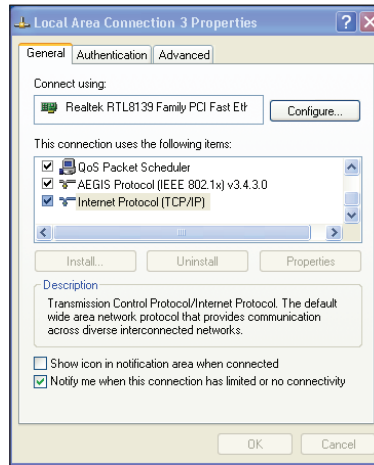

2. Select **Internet Protocol (TCP/IP)**, then click **Properties**.
3. Select **Obtain an IP address automatically** if you want the IP settings to be assigned automatically. Otherwise, select **Use the following IP address**. Key in an **IP address**, **Subnet mask**, and **Default gateway**.
4. Select **Obtain DNS server address automatically** if you want the DNS server settings to be assigned automatically. Otherwise, select **Use the following DNS server addresses**: and key in the **Preferred and Alternate DNS server**.
5. Click **OK**.

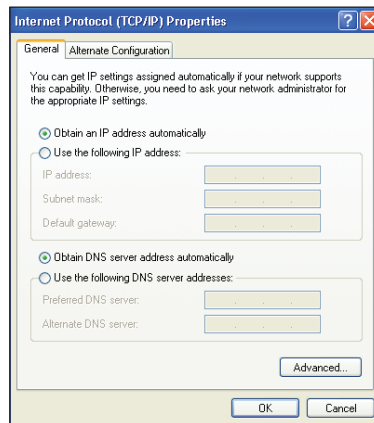

Windows® 7

1. Click **Start > Control Panel > Network and Internet > Network and Sharing Center > Change adapter settings**.
2. On the Network Connections window, click on **Local Area Connection**.
3. On the Local Area Connection Network Status window, click **Properties**.
4. Select Internet Protocol Version 4 (TCP/IPv4) or Internet Protocol Version 6 (TCP/IPV6), then click **Properties**.

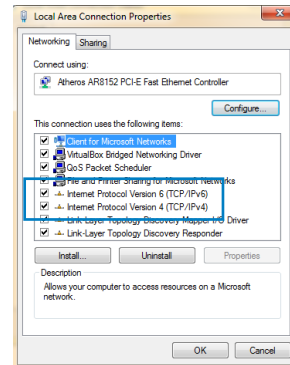
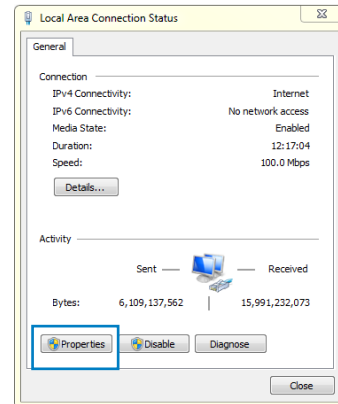
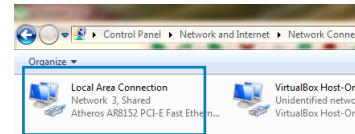
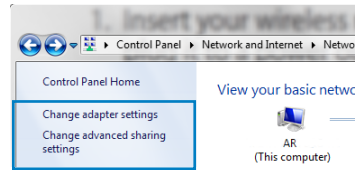



5. Select **Obtain an IP address automatically** if you want the IP settings to be assigned automatically. Otherwise, select **Use the following IP address**. Key in an **IP address**, **Subnet mask**, and **Default gateway**.
6. Select **Obtain DNS server address automatically** if you want the DNS server settings to be assigned automatically. Otherwise, select **Use the following DNS server addresses**: and key in the **Preferred and Alternate DNS server**.
7. Click **OK**.

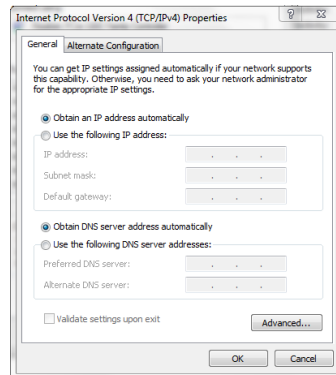







4 Network configuration using the web GUI

Configuration via the web GUI

The router's web graphics user interface (web GUI) allows you to access additional features included with the wireless router.

To access the web GUI:

1. Launch a web browser, then key in the router's IP address.



- In Router mode, the router's IP address is 192.168.1.1.
- In AP mode, use Device Discovery included in the support CD to find the router's IP address.

2. On the login page, key in the default user name (**admin**) and password (**admin**).

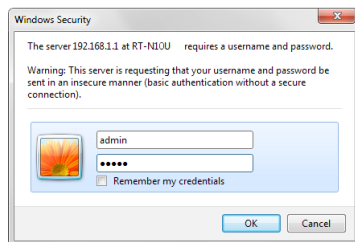

3. From the main page, click the navigation menu and links to configure the various features of the ASUS Wireless Router.





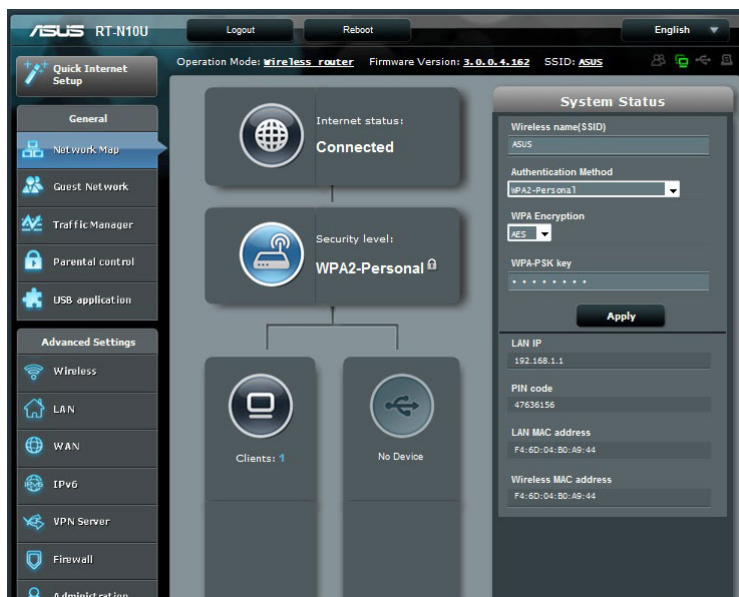

Using the Network Map

Network Map allows you to view the status of the Internet, system, and clients in your network. It enables you to quickly set up your Wide Area Network (WAN) using the Quick Internet Setup (QIS) feature.



To view the status or configure network settings, click any of these icons displayed on the Network Map page:

Icon	Description
	Internet status Click this icon to display information on the Internet connection status, WAN IP address, DNS, connection type, and gateway address. From the Internet status screen, use the Quick Internet Setup (QIS) feature to quickly set up your WAN.
	Security level Click this icon to display information on the SSID, authentication and encryption methods, LAN IP, and MAC address. Click Wireless on the left navigation panel to enable the WPS mode.
	Client status Click this icon to display information about the clients or computers in the network, and allows you to block/unblock a client.
	USB device status Click this icon to display information about your USB device.

Creating your Guest Network

Setting up a Guest Network provides wireless Internet connectivity for temporary visitors while restricting access to your private network.

To create your guest network:

1. Click **Guest Network** on the left navigation panel.
2. Click **Enable**.

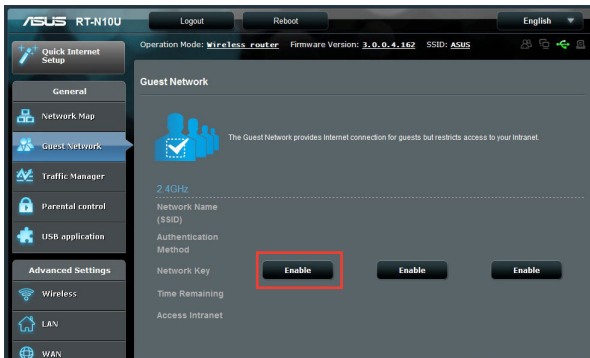

3. To configure additional options, click **Modify**.

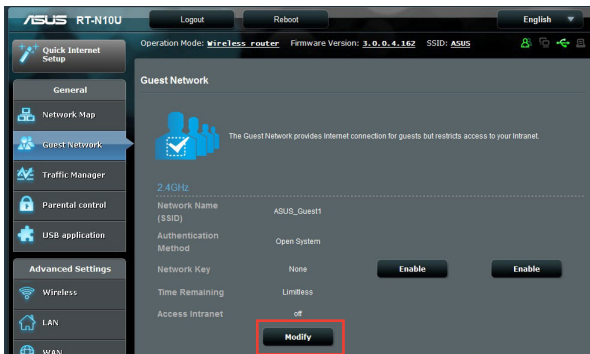

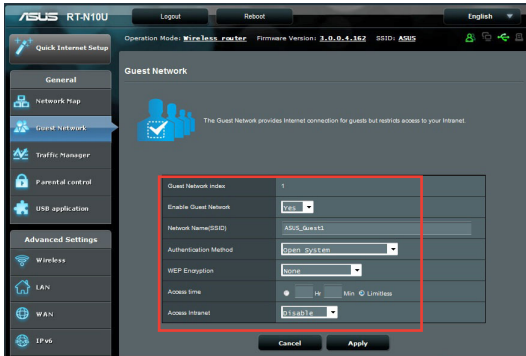

4. Click **Yes** on the **Enable Guest Network?** item.
5. Assign a wireless name for your temporary network on the **Network Name (SSID)** field.
6. Select an **Authentication Method**.
7. Select a **WEP Encryption** method.
8. Specify the **Access time** or click **Limitless**.
9. Select **Disable** or **Enable** on the **Access Intranet** item.
10. Click **Apply**.

Using the Traffic Manager

Managing QoS (Quality of Service) Bandwidth

The **Quality of Service** feature allows you to set the bandwidth priority and manage network traffic.

To set up bandwidth priority:

1. Click **Traffic Manager** on the left navigation panel and click the **QoS** tab.
2. Click **ON** to enable QoS. Fill in the upload and download bandwidth fields.
3. Click **Save**.



Your bandwidth information is available from your ISP.



- If you want to prioritize specific network applications and network services, click **User-define QoS rules** on the upper-right hand corner.

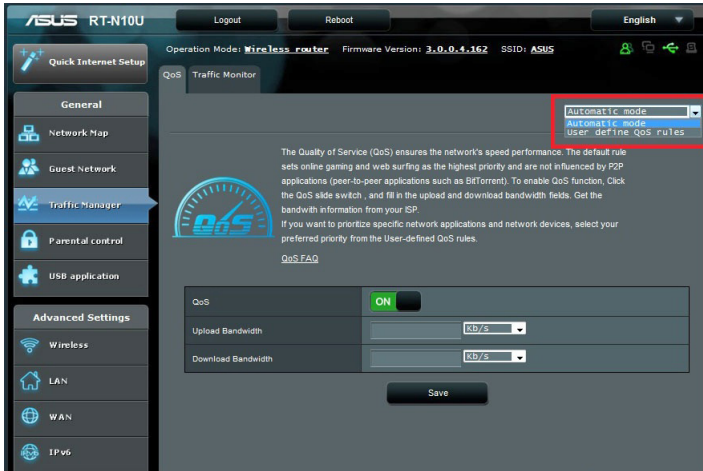

- Online service types, source IP addresses, ports, and protocols can be added and configured in the QoS rules screen.

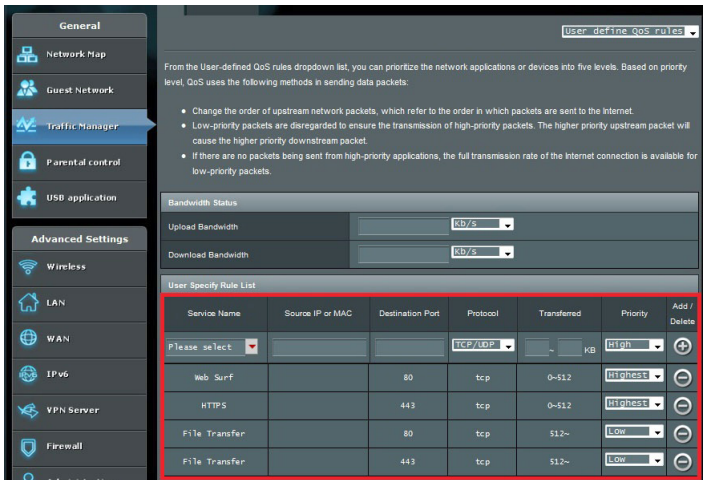

Monitoring Traffic

Click the **Traffic Monitor** tab to view real-time or historical bandwidth information of your Internet, Wired, and Wireless connections.



Administration - Operation Mode

The Operation Mode page allows you to set up your wireless router into any of the three modes: Router mode, Repeater mode, or Access Point mode.

Router Mode

To set up the wireless router in Router mode:

1. Click **Administration** on the navigation panel and click the **Operation Mode** tab. Select **Wireless router mode**. Click **Save**.
2. Select your connection from these types of ISP services: **Dynamic IP**, **PPPoE**, **PPTP**, **L2TP**, and **Static IP**.

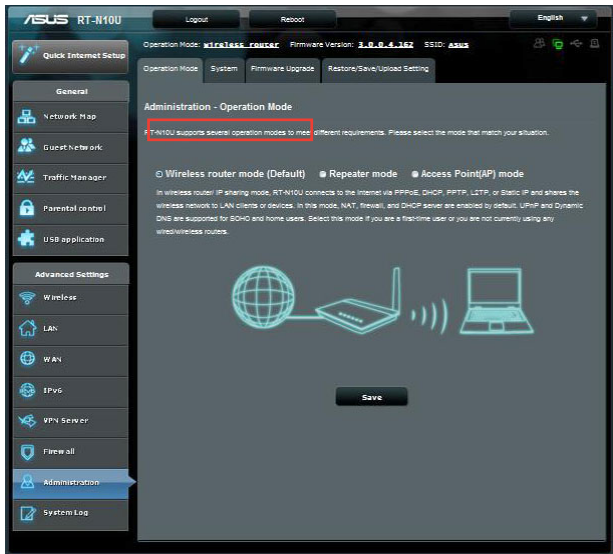

3. Key in the required information of your selected connection type.
4. Click **Apply** to save settings.

Repeater Mode

To set up the wireless router in Repeater mode:

1. Click **Administration** on the navigation panel and click the **Operation Mode** tab. Select **Repeater mode**. Click **Save**.

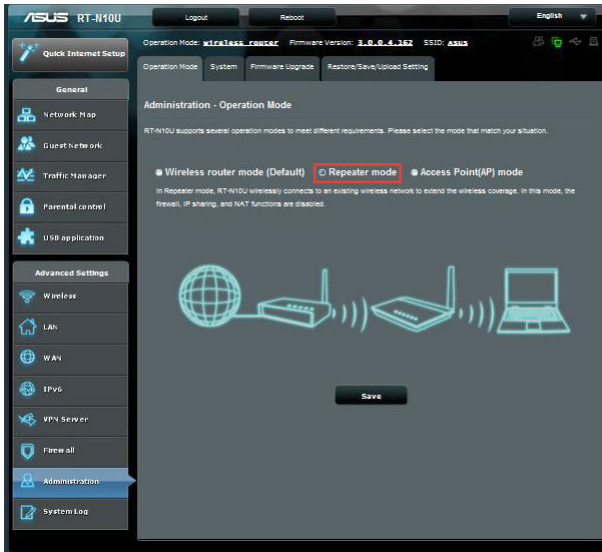

2. Select a wireless network from the list. Click **Connect**.

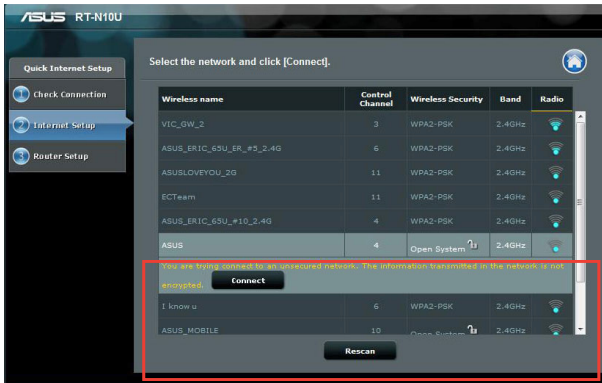

3. Setup complete.

AP (Access Point) Mode

To set up the wireless router in Access Point mode:

1. Click **Administration** on the navigation panel and click the **Operation Mode** tab. Select **Access Point (AP) mode**. Click **Save**.

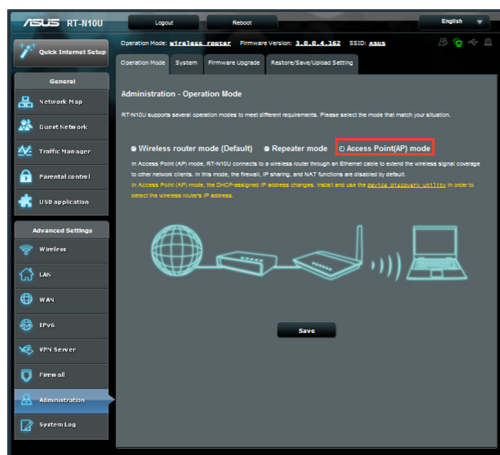

2. Key in network name and password. Click **Apply**.
3. Setup complete.

Using 3G/4G Sharing Mode



The ASUSWRT user interface does not support PIN code input. If the SIM card was previously set with a PIN code, use your mobile phone or a compatible wireless USB dongle to disable the PIN code.

To set up the wireless router in 3G/4G Sharing mode:

1. Click **USB application** on the left navigation panel and click the 3G/4G icon.

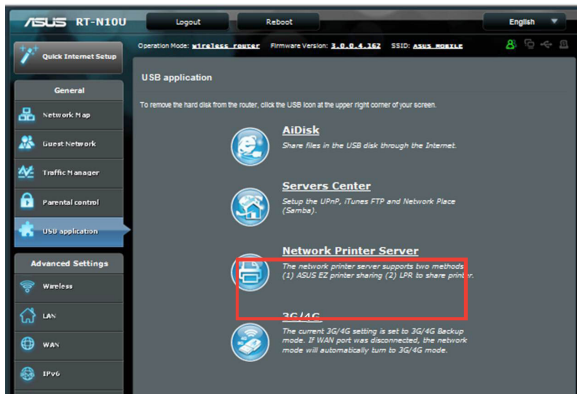

2. On the USB Modem configuration page, click **Yes** for Enable USB Modem.
3. On the USB Adapter item, select your USB adapter's model name. If the model name is not listed, select **AUTO**.

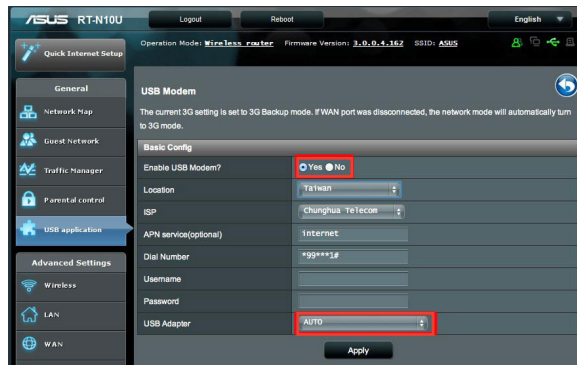

4. Select the **Location** and **ISP** for your service. Key in the **APN**, **Dial Number**, **Username**, and **Password** if necessary.



Please refer to your Internet service provider or telecommunications service for the necessary values for the 3G/4G items.

ASUS RT-N10U

Logout Reboot English

Operation Mode: `wireless_router` Firmware Version: `3.0.0.4.162` SSID: `ASUS`

Quick Internet Setup

General

- Network Map
- General Network
- Traffic Manager
- Parental control
- USB application
- Advanced Settings
 - Wireless
 - LAN
 - WAN

USB Modem

The current 3G setting is set to 3G Backup mode. If WAN port was disconnected, the network mode will automatically turn to 3G mode.

Basic Config

Enable USB Modem?	<input checked="" type="radio"/> Yes <input type="radio"/> No
Location	Taiwan
ISP	Chunghua Telecom
APN service(optional)	internet
Dial Number	+99***1#
Username	
Password	
USB Adapter	AUTO

Apply

5. Setup complete.

Setting up the DHCP Server

Your wireless router uses DHCP to assign IP addresses automatically on your network. You can specify the IP address range and lease time for the clients on your network.



The ASUS wireless router can support up to 253 IP addresses on your network.

To configure the DHCP server:

1. Click **LAN** on the left navigation panel.
2. Click the **DHCP Server** tab.

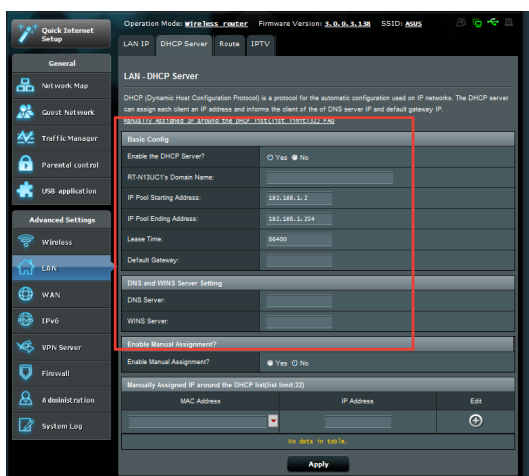

3. In the **Enable the DHCP Server?** field, tick **Yes**.
4. In the **IP Pool Starting Address** field, key in the starting IP address.
5. In the **IP Pool Ending Address** field, key in the ending IP address.
6. In the **Lease Time** field, specify in seconds when an assigned IP address will expire. Once it reaches this time limit, the DHCP server will then assign a new IP address.



- ASUS recommends that you use an IP address format of 192.168.1.xxx (where xxx can be any number between 2 and 254) when specifying an IP address range.
- An IP Pool Starting Address should not be greater than the IP Pool Ending Address.

Upgrading the firmware



Download the latest firmware from the ASUS website at <http://www.asus.com>

To upgrade the firmware:

1. Click **Administration** from the left navigation panel.
2. Click the **Firmware Upgrade** tab.
3. In the **New Firmware File** item, click **Browse**. Navigate to the downloaded firmware file.
4. Click **Upload**.

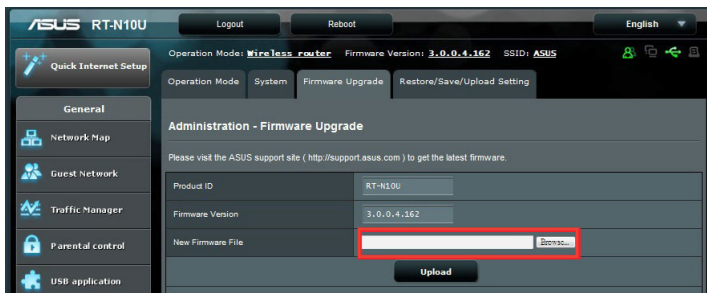

If the upgrade process fails, the wireless router automatically enters rescue mode and the power LED indicator on the front panel starts flashing slowly. To recover or restore the system, use the Firmware Restoration utility.

Restoring/Saving/Uploading settings

To restore/save/upload the settings:

1. Click **Advanced Setting** from the left navigation panel.
2. Click the **Restore/Save/Upload Setting** tab.

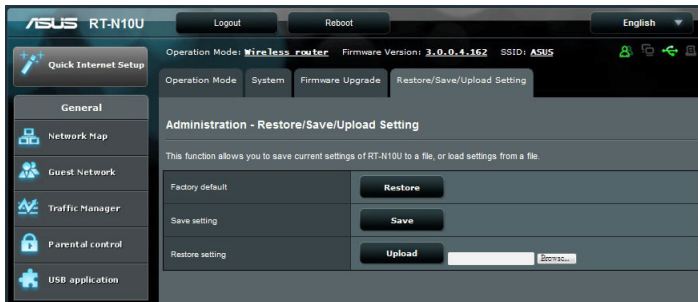

3. Select the tasks that you want to do:
 - To restore to the default factory settings, click **Restore**, and click **OK** once prompted.
 - To save the current system settings, click **Save**, navigate to the folder where you intend to save the file and click **Save**.
 - To restore from a saved system settings file, click **Browse** to locate your file, then click **Upload**.

Using the USB Extension

The USB Extension menu provides **AiDisk**, **Servers Center**, **Network Printer Server** and **3G/4G** submenus.

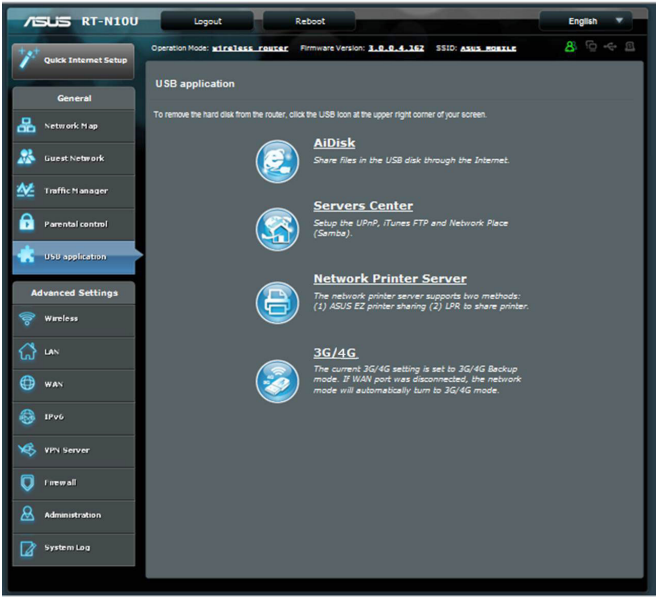

Using AiDisk for File Sharing

AiDisk allows you to share files stored in a connected USB storage device through the Internet.

To use AiDisk:

1. Click **USB application** on the left navigation panel and click the **AiDisk icon**.
2. From the **Welcome to AiDisk wizard** screen, click **Go**.



3. Assign access rights to the USB storage device. **Select limitless access rights, limited access rights, and admin access** to define read-right privileges to files stored in the USB storage device. Click **Next**.



- To set up your domain name via the ASUS DDNS service, select **I will use the service and accept Terms of service** and key in your preferred domain name. Your domain name will follow the format **xxx.asuscomm.com**, where xxx is your host name. For example, **myfiles.asuscomm.com**.
- Click **Next**.

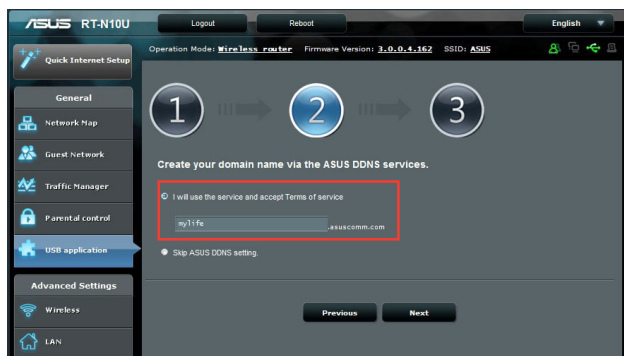

- Click **Finish**.
- To access the USB storage device via FTP from a client on the network, launch a web browser or a third-party FTP client utility and key in the ftp link (**ftp://<hostname>.asuscomm.com**) you previously created. For example, **ftp://myfiles.asuscomm.com**.

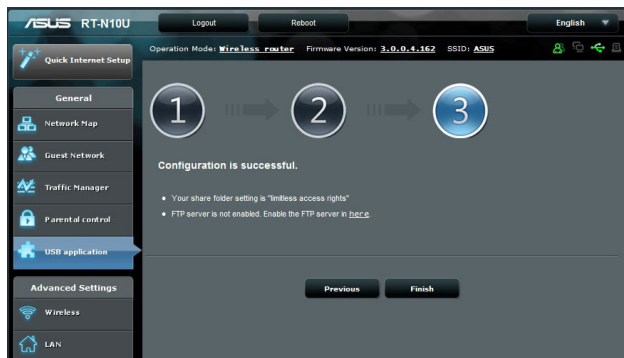

Using the Network Place (Samba) Share service

Network Place (Samba) Share allows you to configure accounts and permissions to access files on the USB storage device.

To use Samba share:

1. Click **USB application** on the left navigation panel and click the **Servers Center** icon.
2. Click the **Network place (Samba) Share** tab.
3. Click **Share with account**. Click **OK** at the pop-up window.

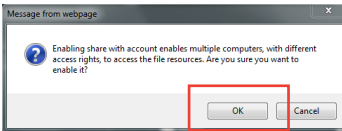
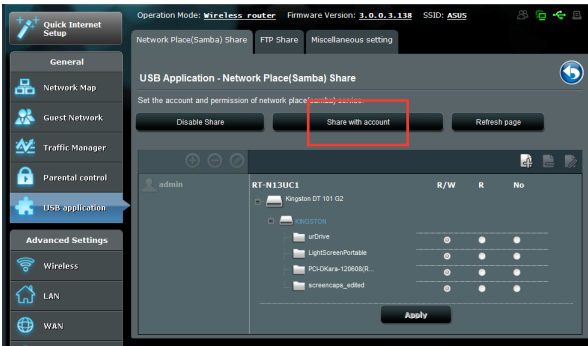

4. Click the **Add** button to create user accounts for users who will be accessing the USB storage device via Samba.

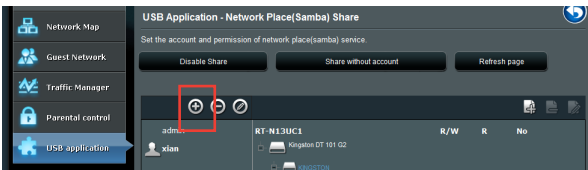

- Assign a name for the user account and key in a password. Click **Add**.



- Use the **Modify** and **Delete** buttons to modify the password or remove the user account.
- Select a user and assign the type of access rights for files or folders located in the storage device:
 - R/W**: Select this option to assign read/write access for a specific file/folder.
 - R**: Select this option to assign read only access for a specific file/folder.
 - No**: Select this option if you do not want to share a specific file/folder.

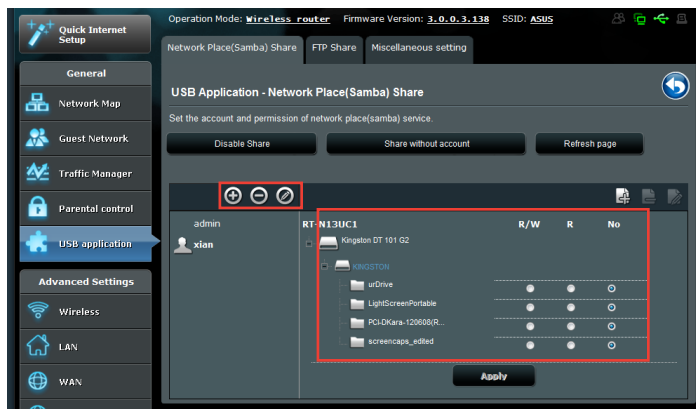

- Click **Apply**.

Using the FTP Share service

Your ASUS wireless router can set up the connected USB storage device as an FTP server.

To set up the FTP Share service:

1. Configure file sharing using the steps in **Using AiDisk for File Sharing**.
2. Enable the DDNS service for FTP server access:
 - a. Click **WAN** on the left navigation panel, then click the **DDNS** tab.
 - b. In the **Enable the DDNS Client?** field, tick **Yes**.
 - c. Select your DDNS Server from the list.
 - d. Key in your Host Name.
 - e. Click **Apply**.

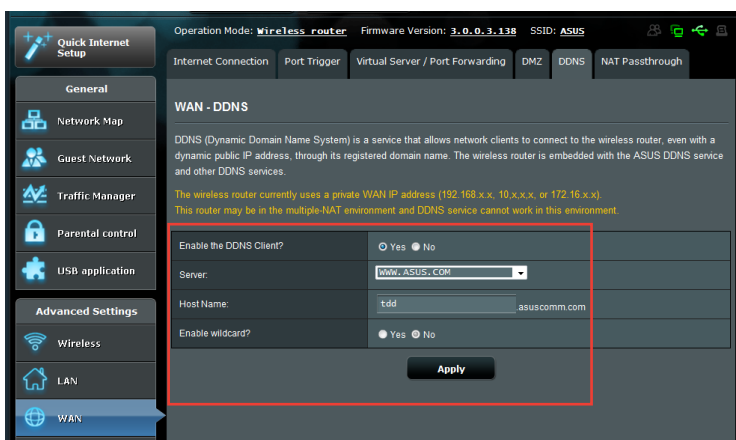

3. Click **USB application** on the left navigation panel and click the **Servers Center** icon.
4. Click the **FTP Share** tab.
5. Click the **Enable FTP** and **Share with account**.

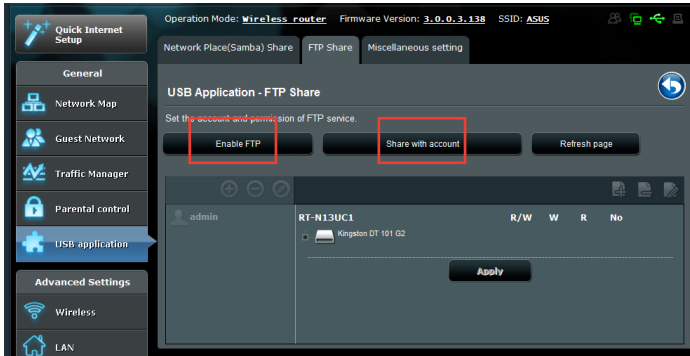

6. Click the **Add** button to create accounts for users who will be accessing the USB storage device via FTP Server.

Assign a name for the user account and key in a password. Click **Add**.



7. Use the **Modify** and **Delete** buttons to modify the password or remove the user account.

8. Select the type of access rights for the storage device:
 - **R/W**: Select this option to assign read/write access for a specific file/folder.
 - **W**: Select this option to assign write only access for a specific file/folder.
 - **R**: Select this option to assign read only access for a specific file/folder.
 - **No**: Select this option if you do not want to share a specific file/folder.

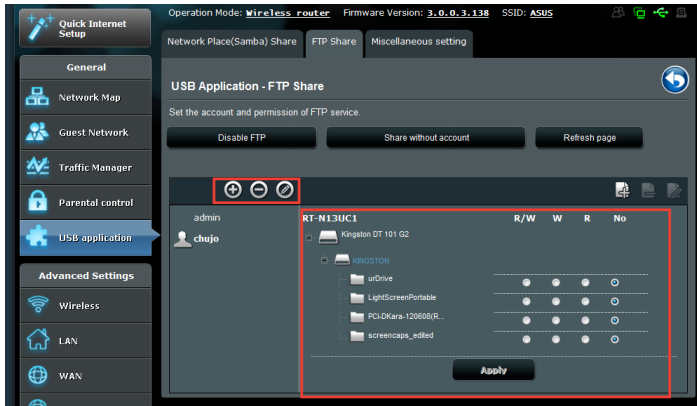

9. Click **Apply**.
10. To access the FTP server from a client on the network, key in **ftp://<hostname>.asuscomm.com** on a web browser or a third-party FTP utility. Once prompted, key in the account username and password.

Using the Miscellaneous setting

The Miscellaneous settings page allows you to configure additional properties for the USB disk. You can change the maximum number of users who can access the USB storage device, assign a device name and work group, or specify the language settings for the FTP server.

To configure additional USB device settings:

1. Click **USB application** on the left navigation panel and click **Servers Center**.
2. Click the **Miscellaneous setting** tab.
3. Specify or change configuration settings as needed.
3. Click **Apply**.

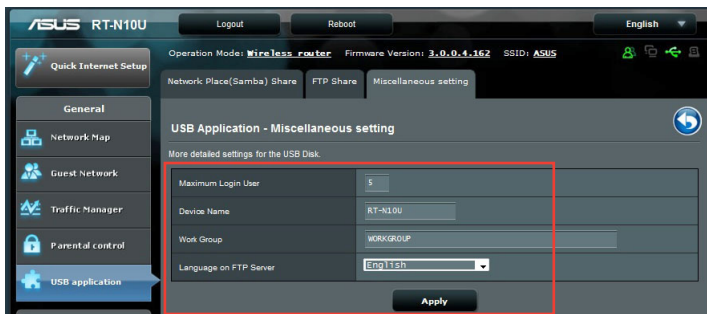



Series of horizontal lines for writing or drawing.





5 Using the utilities

Installing the utilities

The support CD contains the utilities for configuring the ASUS Wireless Router. To install the ASUS WLAN Utilities in Microsoft® Windows, insert the support CD in the CD drive. If Autorun is disabled, run **setup.exe** from the root directory of the support CD.

To install the utilities:

1. Click **Install ASUS Wireless Router Utilities**.

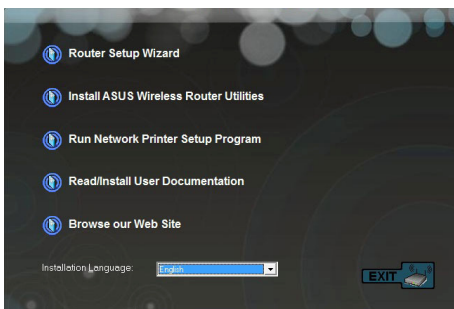

2. Click **Next**.

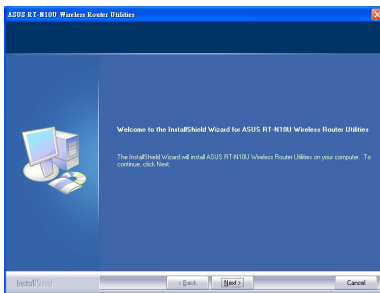

3. Click **Next** to accept the default destination folder or click **Browse** to specify another path.

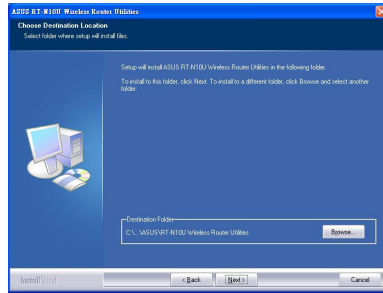

4. Click **Next** to accept the default program folder or enter another name.

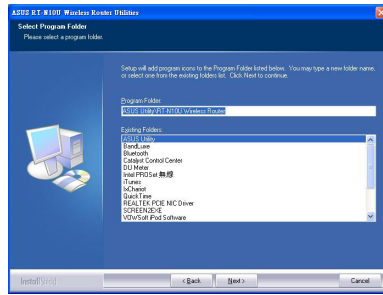

5. Click **Finish**.

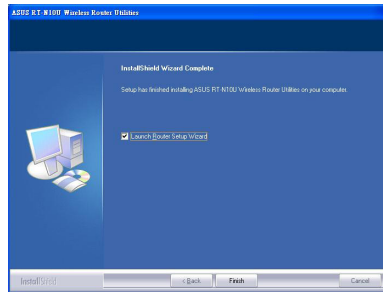

Device Discovery

Device Discovery is an ASUS WLAN utility that detects an ASUS wireless router device, and enables you to configure the device.

To launch the Device Discovery utility:

- From your computer's desktop, click **Start > All Programs > ASUS Utility > RT-N13U Wireless Router > Device Discovery**.

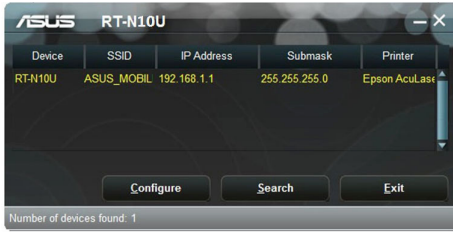

When you set the router to Access Point mode, you need to use Device Discovery to get the router's IP address.

Firmware Restoration

Firmware Restoration is used on an ASUS Wireless Router after a failed firmware upgrade. This utility uploads a firmware file to the wireless router. The process takes about three to four minutes.



Launch rescue mode before using the Firmware Restoration utility.

To launch rescue mode and use the Firmware Restoration utility:

1. Unplug the wireless router from its power source.
2. While holding down the Reset button at the back of the wireless router, plug the wireless router into a power source. Release the Reset button when the Power LED at the front panel begins to flash slowly, which indicates that the wireless router is in rescue mode.
3. Use the following to set up your TCP/IP settings:
IP address: 192.168.1.x
Subnet mask: 255.255.255.0
4. From your computer's desktop, click **Start > All Programs > ASUS Utility RT-N10U Wireless Router > Firmware Restoration.**

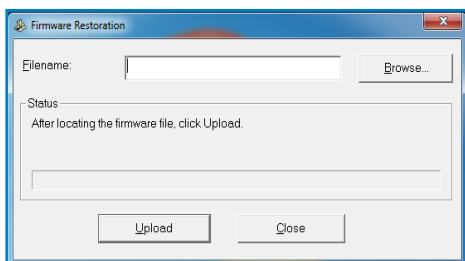

5. Click Browse to navigate to a firmware file, then click **Upload.**



The Firmware Restoration utility is not used to upgrade the firmware of a working ASUS Wireless Router. Normal firmware upgrades must be done through the web GUI. Refer to **Upgrading the firmware** on page 44 for more details.

Setting up your network printer

Use the Network Printer Setup utility to set up a USB printer on your wireless router and share the printer with other devices on the network.



- To check if your USB printer is compatible with your ASUS wireless router, refer to the Plug-n-Share Disk Support List at <http://event.asus.com/networks/printersupport>
- The wireless router's printer server function is not supported on Windows® 2000.

To set up your USB Printer:

1. Click **USB application** from the left navigation panel, then click **Network Printer Server**.
2. Click **Download Now!** to download the network printer utility.



3. Unzip the downloaded file and click the Printer.exe file to run the network printer setup program.



Printer.exe
ASUS Wireless Router Utility
ASUSTek COMPUTER INC.

4. Follow the onscreen instructions to set up your hardware, then click **Next**.

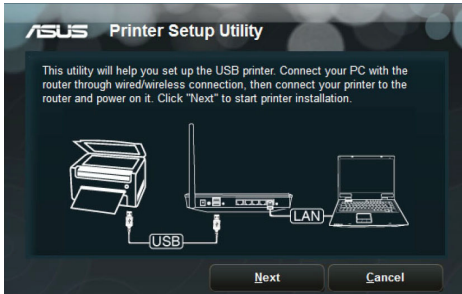

5. Wait for a few minutes for the initial setup to finish. Click **Next**.

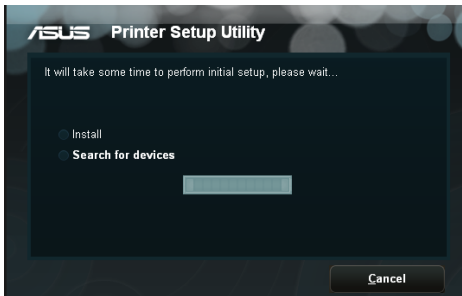

6. Click **Finish** to complete the installation.



7. Follow the Windows® OS instructions to install the printer driver.

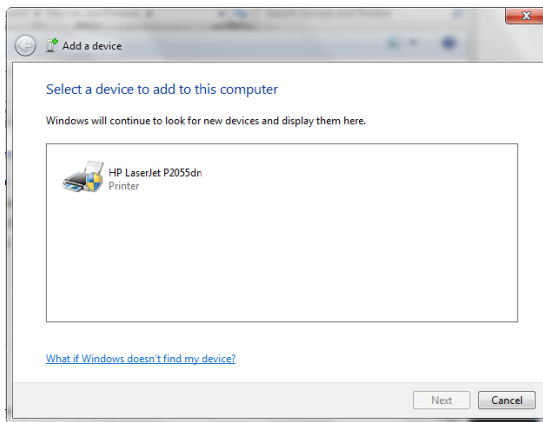

8. After printer driver installation is complete, computers on the network will now be able to access the printer.

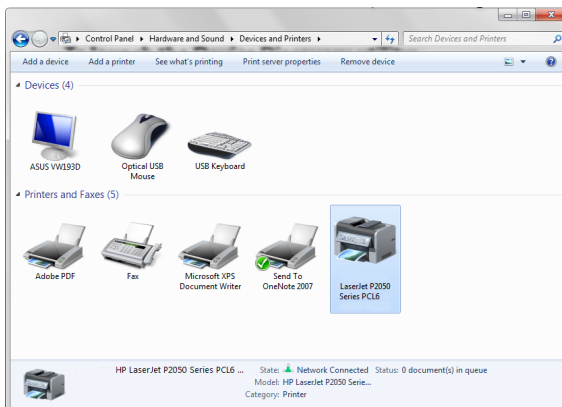



A series of 20 horizontal lines spaced evenly down the page, providing a template for text or drawing.



Troubleshooting 6

Troubleshooting

This troubleshooting guide provides solutions to some common problems that you may encounter while installing or using the ASUS Wireless Router. These problems require simple troubleshooting that you can perform by yourself. Contact the ASUS Technical Support if you encounter problems not mentioned in this chapter.

Problem	Action
I cannot access the web GUI for configuring the router.	<ol style="list-style-type: none">1. Launch a web browser, then click Tools > Internet Options...2. Under Temporary Internet files, click Delete Cookies... and Delete Files...3. Disable the proxy settings of the web browser.
The client cannot establish a wireless connection with the router.	<p>Out of Range:</p> <ul style="list-style-type: none">• Put the router closer to the wireless client.• Try to change the channel settings. <p>Authentication:</p> <ul style="list-style-type: none">• Use a wired connection to connect to the router.• Check the wireless security settings.• Press the Reset button at the rear panel for more than five seconds. <p>Cannot find the router:</p> <ul style="list-style-type: none">• Press the Restore button at the rear panel for more than five seconds.• Check the setting in the wireless adapter such as SSID and encryption settings.



Problem	Action
Cannot access the Internet via wireless LAN adapter.	<ul style="list-style-type: none">• Move the router closer to the wireless client.• Check whether the wireless adapter is connected to the correct wireless router.• Check whether the wireless channel in use conforms to the channels available in your country/area.• Check the encryption settings.• Check if the ADSL or Cable connection is correct.• Retry using another Ethernet cable.
Internet is not accessible.	<ul style="list-style-type: none">• Check the status indicators on the ADSL modem and the wireless router.• Check if the WAN LED on the wireless router is ON. If the LED is not ON, change the cable and try again.
When ADSL Modem “Link” light is ON (not blinking), this means Internet Access is possible.	<ul style="list-style-type: none">• Restart your computer.• Refer to the Quick Start Guide of the wireless router and re-configure the settings.• Check if the WAN LED on the wireless router is ON.• Check the wireless encryption settings.• Check if the computer can get the IP address (via both wired network and wireless network).• Ensure that your web browser is configured to use the local LAN, and is not configured to use a proxy server.
If the ADSL “LINK” light blinks continuously or stays off, Internet access is not possible - the Router is unable to establish a connection with the ADSL network.	<ul style="list-style-type: none">• Ensure that all your cables are all properly connected .• Disconnect the power cord from the ADSL or cable modem, wait a few minutes, then reconnect the cord.• If the ADSL light continues to blink or stays OFF, contact your ADSL service provider.
Network name or encryption keys are forgotten.	<ul style="list-style-type: none">• Try setting up the wired connection and configuring the wireless encryption again.• Press the Reset button at the rear panel of the wireless router for more than five seconds.





Problem	Action
How to restore the system to its default settings?	<ul style="list-style-type: none">• Press the Restore button at the rear panel of the wireless router for more than five seconds.• Refer to the section Restoring/Saving/Uploading settings in Chapter 4 of this user manual. <p>The following are the factory default settings:</p> <p>User Name: admin Password: admin Enable DHCP: Yes (if WAN cable is plugged in) IP address: 192.168.1.1 Domain Name: (Blank) Subnet Mask: 255.255.255.0 DNS Server 1: 192.168.1.1 DNS Server 2: (Blank) SSID: ASUS</p>
I cannot use 192.168.1.1 to enter the web GUI.	<p>Check the router's operation mode.</p> <ul style="list-style-type: none">• In the Router mode, the default IP address is 192.168.1.1.• In the AP mode, use Device Discovery to find the router's IP address.





ASUS DDNS Service

RT-N10U supports the ASUS DDNS service. When exchanging devices at the service center, if you have registered the ASUS DDNS service and want to keep the original domain name, you must transfer your data in order to retain the DDNS service. Visit your local service center for more information.



- If there is no activity in the domain - such as reconfiguring the router or accessing the registered domain name - within 90 days, the system automatically deletes the registered information.
- If you encounter any problem or difficulty in using your device, contact the service center.

Frequently Asked Questions (FAQs)

1. Will the registered information be lost or registered by others?

If you have not updated the registered information in 90 days, the system automatically deletes the registered information and the domain name may be registered by others.

2. I did not register the ASUS DDNS for the router I bought six months ago. Can I still register it?

Yes, you can still register the ASUS DDNS service for your router. The DDNS service is embedded in your router, so you can register the ASUS DDNS service anytime. Before registering, click **Query** to check if the hostname has been registered or not. If not, the system registers the hostname automatically.

3. I have registered a domain name before and it has been working well until my friends told me that they could not access my domain name.

Check the following:

1. The internet is working properly.
2. The DNS server is working properly.
3. The last time you updated the domain name.

If there are still problems in accessing your domain name, contact the service center.

4. Can I register two domain names to access my http and ftp servers separately?

No, you cannot. You can only register one domain name for one router. Use port mapping to implement security in the network.





5. After restarting the router, why is it that I see different WAN IPs in MS-DOS and in the router configuration page?

This is normal. The interval time between the ISP DNS server and ASUS DDNS results in different WAN IPs in MS-DOS and in the router configuration page. Different ISPs may have different interval time for IP updating.

6. Is the ASUS DDNS service free, or is it just a trial version?

The ASUS DDNS service is a free and embedded service in some ASUS routers. Check if your ASUS router supports the ASUS DDNS service.





A series of 20 horizontal lines spaced evenly down the page, providing a template for writing or drawing.



Appendices

Notices

ASUS Recycling/Takeback Services

ASUS recycling and takeback programs come from our commitment to the highest standards for protecting our environment. We believe in providing solutions for you to be able to responsibly recycle our products, batteries, other components, as well as the packaging materials. Please go to <http://csr.asus.com/english/Takeback.htm> for the detailed recycling information in different regions.

REACH

Complying with the REACH (Registration, Evaluation, Authorisation, and Restriction of Chemicals) regulatory framework, we published the chemical substances in our products at ASUS REACH website at <http://csr.asus.com/english/REACH.htm>

Federal Communications Commission Statement

This device complies with Part 15 of the FCC Rules. Operation is subject to the following two conditions:

- This device may not cause harmful interference.
- This device must accept any interference received, including interference that may cause undesired operation.

This equipment has been tested and found to comply with the limits for a class B digital device, pursuant to part 15 of the FCC Rules. These limits are designed to provide reasonable protection against harmful interference in a residential installation.

This equipment generates, uses and can radiate radio frequency energy and, if not installed and used in accordance with the instructions, may cause harmful interference to radio communications. However, there is no guarantee that interference will not occur in a particular installation. If this equipment does cause harmful interference to radio or television reception, which can be determined by turning the equipment off and on, the user is encouraged to try to correct the interference by one or more of the following measures:

- Reorient or relocate the receiving antenna.
- Increase the separation between the equipment and receiver.
- Connect the equipment into an outlet on a circuit different from that to which the receiver is connected.
- Consult the dealer or an experienced radio/TV technician for help.



Warning: Any changes or modifications not expressly approved by the party responsible for compliance could void the user's authority to operate the equipment.



Prohibition of Co-location

This device and its antenna(s) must not be co-located or operating in conjunction with any other antenna or transmitter.

Safety Information

To maintain compliance with FCC's RF exposure guidelines, this equipment should be installed and operated with minimum distance 20cm between the radiator and your body. Use on the supplied antenna.

Declaration of Conformity for R&TTE directive 1999/5/EC

Essential requirements – Article 3

Protection requirements for health and safety – Article 3.1a

Testing for electric safety according to EN 60950-1 has been conducted. These are considered relevant and sufficient.

Protection requirements for electromagnetic compatibility – Article 3.1b

Testing for electromagnetic compatibility according to EN 301 489-1 and EN 301 489-17 has been conducted. These are considered relevant and sufficient.

Effective use of the radio spectrum – Article 3.2

Testing for radio test suites according to EN 300 328- 2 has been conducted. These are considered relevant and sufficient.

CE Mark Warning

This is a Class B product, in a domestic environment, this product may cause radio interference, in which case the user may be required to take adequate measures.

Operation Channels: Ch1~11 for N. America, Ch1~14 Japan, Ch1~13 Europe (ETSI)

IC Warning

The Class B digital apparatus meets all requirements of the Canadian Interference-Causing Equipment Regulation.

Cet appareil numérique de la class B respecte toutes les exigences du Reglement sur le materiel brouilleur du Canada.

GNU General Public License

Licensing information

This product includes copyrighted third-party software licensed under the terms of the GNU General Public License. Please see The GNU General Public License for the exact terms and conditions of this license. We include a copy of the GPL with every CD shipped with our product. All future firmware updates will also





be accompanied with their respective source code. Please visit our web site for updated information. Note that we do not offer direct support for the distribution.

GNU GENERAL PUBLIC LICENSE

Version 2, June 1991

Copyright (C) 1989, 1991 Free Software Foundation, Inc.

59 Temple Place, Suite 330, Boston, MA 02111-1307 USA

Everyone is permitted to copy and distribute verbatim copies of this license document, but changing it is not allowed.

Preamble

The licenses for most software are designed to take away your freedom to share and change it. By contrast, the GNU General Public License is intended to guarantee your freedom to share and change free software--to make sure the software is free for all its users. This General Public License applies to most of the Free Software Foundation's software and to any other program whose authors commit to using it. (Some other Free Software Foundation software is covered by the GNU Library General Public License instead.) You can apply it to your programs, too.

When we speak of free software, we are referring to freedom, not price. Our General Public Licenses are designed to make sure that you have the freedom to distribute copies of free software (and charge for this service if you wish), that you receive source code or can get it if you want it, that you can change the software or use pieces of it in new free programs; and that you know you can do these things.

To protect your rights, we need to make restrictions that forbid anyone to deny you these rights or to ask you to surrender the rights. These restrictions translate to certain responsibilities for you if you distribute copies of the software, or if you modify it.

For example, if you distribute copies of such a program, whether gratis or for a fee, you must give the recipients all the rights that you have. You must make sure that they, too, receive or can get the source code. And you must show them these terms so they know their rights.

We protect your rights with two steps: (1) copyright the software, and (2) offer you this license which gives you legal permission to copy, distribute and/or modify the software.

Also, for each author's protection and ours, we want to make certain that everyone understands that there is no warranty for this free software. If the software is modified by someone else and passed on, we want its recipients to know that what they have is not the original, so that any problems introduced by others will not reflect on the original authors' reputations.





Finally, any free program is threatened constantly by software patents. We wish to avoid the danger that redistributors of a free program will individually obtain patent licenses, in effect making the program proprietary. To prevent this, we have made it clear that any patent must be licensed for everyone's free use or not licensed at all. The precise terms and conditions for copying, distribution and modification follow.

Terms & conditions for copying, distribution, & modification

0. This License applies to any program or other work which contains a notice placed by the copyright holder saying it may be distributed under the terms of this General Public License. The "Program", below, refers to any such program or work, and a "work based on the Program" means either the Program or any derivative work under copyright law: that is to say, a work containing the Program or a portion of it, either verbatim or with modifications and/or translated into another language. (Hereinafter, translation is included without limitation in the term "modification".) Each licensee is addressed as "you".

Activities other than copying, distribution and modification are not covered by this License; they are outside its scope. The act of running the Program is not restricted, and the output from the Program is covered only if its contents constitute a work based on the Program (independent of having been made by running the Program). Whether that is true depends on what the Program does.

1. You may copy and distribute verbatim copies of the Program's source code as you receive it, in any medium, provided that you conspicuously and appropriately publish on each copy an appropriate copyright notice and disclaimer of warranty; keep intact all the notices that refer to this License and to the absence of any warranty; and give any other recipients of the Program a copy of this License along with the Program.

You may charge a fee for the physical act of transferring a copy, and you may at your option offer warranty protection in exchange for a fee.

2. You may modify your copy or copies of the Program or any portion of it, thus forming a work based on the Program, and copy and distribute such modifications or work under the terms of Section 1 above, provided that you also meet all of these conditions:
 - a) You must cause the modified files to carry prominent notices stating that you changed the files and the date of any change.
 - b) You must cause any work that you distribute or publish, that in whole or in part contains or is derived from the Program or any part thereof, to be licensed as a whole at no charge to all third parties under the terms of this License.
 - c) If the modified program normally reads commands interactively when run, you must cause it, when started running for such interactive use in the most ordinary way, to print or display an announcement including an appropriate copyright notice and a notice that there is no warranty (or else, saying that you provide a warranty) and that users may redistribute the program under these conditions, and telling the user how to view a copy of this License.





(Exception: if the Program itself is interactive but does not normally print such an announcement, your work based on the Program is not required to print an announcement.)

These requirements apply to the modified work as a whole. If identifiable sections of that work are not derived from the Program, and can be reasonably considered independent and separate works in themselves, then this License, and its terms, do not apply to those sections when you distribute them as separate works. But when you distribute the same sections as part of a whole which is a work based on the Program, the distribution of the whole must be on the terms of this License, whose permissions for other licensees extend to the entire whole, and thus to each and every part regardless of who wrote it.

Thus, it is not the intent of this section to claim rights or contest your rights to work written entirely by you; rather, the intent is to exercise the right to control the distribution of derivative or collective works based on the Program.

In addition, mere aggregation of another work not based on the Program with the Program (or with a work based on the Program) on a volume of a storage or distribution medium does not bring the other work under the scope of this License.

3. You may copy and distribute the Program (or a work based on it, under Section 2) in object code or executable form under the terms of Sections 1 and 2 above provided that you also do one of the following:
 - a) Accompany it with the complete corresponding machine-readable source code, which must be distributed under the terms of Sections 1 and 2 above on a medium customarily used for software interchange; or,
 - b) Accompany it with a written offer, valid for at least three years, to give any third party, for a charge no more than your cost of physically performing source distribution, a complete machine-readable copy of the corresponding source code, to be distributed under the terms of Sections 1 and 2 above on a medium customarily used for software interchange; or,
 - c) Accompany it with the information you received as to the offer to distribute corresponding source code. (This alternative is allowed only for noncommercial distribution and only if you received the program in object code or executable form with such an offer, in accord with Subsection b above.)

The source code for a work means the preferred form of the work for making modifications to it. For an executable work, complete source code means all the source code for all modules it contains, plus any associated interface definition files, plus the scripts used to control compilation and installation of the executable. However, as a special exception, the source code distributed need not include anything that is normally distributed (in either source or binary form) with the major components (compiler, kernel, and so on) of the operating system on which the executable runs, unless that component itself accompanies the executable.

If distribution of executable or object code is made by offering access to copy from a designated place, then offering equivalent access to copy the source code from the same place counts as distribution of the source code, even





though third parties are not compelled to copy the source along with the object code.

4. You may not copy, modify, sublicense, or distribute the Program except as expressly provided under this License. Any attempt otherwise to copy, modify, sublicense or distribute the Program is void, and will automatically terminate your rights under this License. However, parties who have received copies, or rights, from you under this License will not have their licenses terminated so long as such parties remain in full compliance.
5. You are not required to accept this License, since you have not signed it. However, nothing else grants you permission to modify or distribute the Program or its derivative works. These actions are prohibited by law if you do not accept this License. Therefore, by modifying or distributing the Program (or any work based on the Program), you indicate your acceptance of this License to do so, and all its terms and conditions for copying, distributing or modifying the Program or works based on it.
6. Each time you redistribute the Program (or any work based on the Program), the recipient automatically receives a license from the original licensor to copy, distribute or modify the Program subject to these terms and conditions. You may not impose any further restrictions on the recipients' exercise of the rights granted herein. You are not responsible for enforcing compliance by third parties to this License.
7. If, as a consequence of a court judgment or allegation of patent infringement or for any other reason (not limited to patent issues), conditions are imposed on you (whether by court order, agreement or otherwise) that contradict the conditions of this License, they do not excuse you from the conditions of this License. If you cannot distribute so as to satisfy simultaneously your obligations under this License and any other pertinent obligations, then as a consequence you may not distribute the Program at all. For example, if a patent license would not permit royalty-free redistribution of the Program by all those who receive copies directly or indirectly through you, then the only way you could satisfy both it and this License would be to refrain entirely from distribution of the Program.

If any portion of this section is held invalid or unenforceable under any particular circumstance, the balance of the section is intended to apply and the section as a whole is intended to apply in other circumstances.

It is not the purpose of this section to induce you to infringe any patents or other property right claims or to contest validity of any such claims; this section has the sole purpose of protecting the integrity of the free software distribution system, which is implemented by public license practices. Many people have made generous contributions to the wide range of software distributed through that system in reliance on consistent application of that system; it is up to the author/donor to decide if he or she is willing to distribute software through any other system and a licensee cannot impose that choice.





This section is intended to make thoroughly clear what is believed to be a consequence of the rest of this License.

8. If the distribution and/or use of the Program is restricted in certain countries either by patents or by copyrighted interfaces, the original copyright holder who places the Program under this License may add an explicit geographical distribution limitation excluding those countries, so that distribution is permitted only in or among countries not thus excluded. In such case, this License incorporates the limitation as if written in the body of this License.

9. The Free Software Foundation may publish revised and/or new versions of the General Public License from time to time. Such new versions will be similar in spirit to the present version, but may differ in detail to address new problems or concerns.

Each version is given a distinguishing version number. If the Program specifies a version number of this License which applies to it and “any later version”, you have the option of following the terms and conditions either of that version or of any later version published by the Free Software Foundation. If the Program does not specify a version number of this License, you may choose any version ever published by the Free Software Foundation.

10. If you wish to incorporate parts of the Program into other free programs whose distribution conditions are different, write to the author to ask for permission. For software which is copyrighted by the Free Software Foundation, write to the Free Software Foundation; we sometimes make exceptions for this. Our decision will be guided by the two goals of preserving the free status of all derivatives of our free software and of promoting the sharing and reuse of software generally.

NO WARRANTY

- 11 BECAUSE THE PROGRAM IS LICENSED FREE OF CHARGE, THERE IS NO WARRANTY FOR THE PROGRAM, TO THE EXTENT PERMITTED BY APPLICABLE LAW. EXCEPT WHEN OTHERWISE STATED IN WRITING THE COPYRIGHT HOLDERS AND/OR OTHER PARTIES PROVIDE THE PROGRAM “AS IS” WITHOUT WARRANTY OF ANY KIND, EITHER EXPRESSED OR IMPLIED, INCLUDING, BUT NOT LIMITED TO, THE IMPLIED WARRANTIES OF MERCHANTABILITY AND FITNESS FOR A PARTICULAR PURPOSE. THE ENTIRE RISK AS TO THE QUALITY AND PERFORMANCE OF THE PROGRAM IS WITH YOU. SHOULD THE PROGRAM PROVE DEFECTIVE, YOU ASSUME THE COST OF ALL NECESSARY SERVICING, REPAIR OR CORRECTION.

- 12 IN NO EVENT UNLESS REQUIRED BY APPLICABLE LAW OR AGREED TO IN WRITING WILL ANY COPYRIGHT HOLDER, OR ANY OTHER PARTY WHO MAY MODIFY AND/OR REDISTRIBUTE THE PROGRAM AS PERMITTED ABOVE, BE LIABLE TO YOU FOR DAMAGES, INCLUDING ANY GENERAL, SPECIAL, INCIDENTAL OR CONSEQUENTIAL DAMAGES





ARISING OUT OF THE USE OR INABILITY TO USE THE PROGRAM (INCLUDING BUT NOT LIMITED TO LOSS OF DATA OR DATA BEING RENDERED INACCURATE OR LOSSES SUSTAINED BY YOU OR THIRD PARTIES OR A FAILURE OF THE PROGRAM TO OPERATE WITH ANY OTHER PROGRAMS), EVEN IF SUCH HOLDER OR OTHER PARTY HAS BEEN ADVISED OF THE POSSIBILITY OF SUCH DAMAGES.

END OF TERMS AND CONDITIONS

NCC Warning

經型式認證合格之低功率射頻電機，非經許可，公司、商號或使用者均不得擅自變更頻率、加大功率或變更原設計之特性及功能。

低功率射頻電機之使用不得影響飛航安全及干擾合法通信；經發現有干擾現象時，應立即停用，並改善至無干擾時方得繼續使用。

前項合法通信，指依電信法規定作業之無線電通信。

低功率射頻電機須忍受合法通信或工業、科學及醫療用電波輻射性電機設備之干擾。

Safety Warning

SAFE TEMP: This wireless router should be only used in environments with ambient temperatures between 5°C(41°F) and 40°C(104°F).

DO NOT expose to or use near liquids, rain, or moisture. DO NOT use the modem during electrical storms.





ASUS Contact Information

ASUSTeK COMPUTER INC. (Asia Pacific)

Address 15 Li-Te Road, Peitou, Taipei, Taiwan 11259
Website www.asus.com.tw

Technical Support

Telephone +886228943447
Support Fax +886228907698
Online support support.asus.com

ASUS COMPUTER INTERNATIONAL (America)

Address 800 Corporate Way, Fremont, CA 94539, USA
Telephone +15029550883
Fax +15029338713
Website usa.asus.com
Online support support.asus.com

ASUS COMPUTER GmbH (Germany and Austria)

Address Harkort Str. 21-23, D-40880 Ratingen, Germany
Fax +492102959911
Website www.asus.de
Online contact www.asus.de/sales

Technical Support

Telephone (Component) +491805010923*
Telephone (System/Notebook/Eee/LCD) +491805010920*
Fax +492102959911
Online support support.asus.com

* EUR 0.14/minute from a German fixed landline; EUR 0.42/minute from a mobile phone.





Manufacturer:	ASUSTeK Computer Inc. Tel: +886-2-2894-3447 Address: No. 150, LI-TE RD., PEITOU, TAIPEI 112, TAIWAN
Authorised representative in Europe:	ASUS Computer GmbH Address: HARKORT STR. 21-23, 40880 RATINGEN, GERMANY
Authorised distributors in Turkey:	BOGAZICI BIL GISAYAR SAN. VE TIC. A.S. Tel: +90 212 3311000 Address: AYAZAGA MAH. KEMERBURGAZ CAD. NO.10 AYAZAGA/ISTANBUL
	CIZGI Elektronik San. Tic. Ltd. Sti. Tel: 0090 2123567070 Address: CEMAL SURURI CD. HALIM MERIC IS MERKEZI No:15/C D: 5-6 34394 MECIDIYEKOY/ISTANBUL

EEE Yönetmeliğine Uygundur.

