



Table of Contents

1. Introduction	1
Advantages of a Wireless Network	1
Placement of your Router	2
2. Product Overview	6
Product Features	6
3. Knowing your Router	9
Package Contents	9
System Requirements	9
Assistant Software System Requirements	9
Hardware Characteristics	10
4. Connecting and Configuring your Router	14
Step 1: Hardware Connections – Follow the Quick Installation Guide	16
Step 2: Set Up the Router – Using the Plug-and-Play Router Setup	18
Step 3: Set Up Wireless Security – Run the Security Assistant Software	32
5. Alternate Setup Method	34
6. Using the Web-Based Advanced User Interface	47
Changing LAN Settings	48
Viewing the DHCP Client List Page	50
Configuring the Wireless Network Settings	50
Setting WPA Security	59
Setting WEP Encryption	61
Setting MAC Address Control	63
Configuring the Firewall	65
Using Dynamic DNS	69
Utilities	72
Restarting the Router	74
Updating the Firmware	79
7. Manually Configuring Network Settings	87
8. Recommended Web Browser Settings	92
9. Troubleshooting	94
10. Information	110

Introduction

Thank you for purchasing the Belkin N1 Vision Wireless Modem Router (the Router). Following are two short sections—the first discusses the benefits of home networking, and the other outlines best practices that maximize your wireless home network range and performance. Please be sure to read through this User Manual completely, and pay special attention to the section entitled “Placement of your Wireless Networking Hardware for Optimal Performance” on the next page. By following our simple setup instructions you will be able to use your Belkin Home Network to:

- Share one high-speed Internet connection with all the computers in your home
- Share resources, such as files and hard drives among all the connected computers in your home
- Share a single printer with the entire family
- Share documents, music, video, and digital pictures
- Store, retrieve, and copy files from one computer to another
- Simultaneously play games online, check Internet email, and chat

Advantages of a Wireless Network

Here are some of the advantages of setting up a Belkin Wireless Network:

- **Mobility** – you’ll no longer need a dedicated “computer room”—now you can work on a networked laptop or desktop computer anywhere within your wireless range
- **Easy installation** – Belkin’s Easy Installation Wizard makes setup simple
- **Flexibility** – set up and access printers, computers, and other networking devices from anywhere in your home
- **Easy expansion** – the wide range of Belkin networking products let you expand your network to include devices such as printers and gaming consoles
- **No cabling required** – you can spare the expense and hassle of retrofitting Ethernet cabling throughout the home or office
- **Widespread industry acceptance** – choose from a wide range of interoperable networking products

Revolutionary N1 Wireless Technology with MIMO (N1 MIMO)

Your Belkin N1 Vision Wireless Modem Router uses a new smart-antenna technology called Multiple Input Multiple Output (MIMO). N1 MIMO complies with the IEEE draft 802.11n specification. It increases speed, range, reliability, and spectral efficiency for wireless networking systems.

The element that makes Belkin's N1 MIMO technology different from a conventional radio is the use of multiple antennas and two simultaneous data streams to deliver wireless transfers around your home or office. A conventional radio uses one antenna to transmit a data stream. Belkin's N1 MIMO technology, on the other hand, uses three antennas. This design helps combat distortion and interference. Belkin's N1 MIMO is multidimensional. It builds on one-dimensional smart-antenna technology by simultaneously transmitting two data streams through the same channel, which increases wireless capacity.

Another element that enhances Belkin's N1 MIMO technology is the use of aggregation as specified in the draft 802.11n standard. By shortening the space between packets and combining multiple smaller packets into one larger packet, Belkin's N1 MIMO technology can transmit more data through available bandwidth.

Think of conventional radio transmission as a two-lane highway. The speed limit governs the maximum allowable flow of traffic through that lane. Compared with conventional radios, one-dimensional smart-antenna systems help move traffic through that lane faster and more reliably— analogous to a four-lane road on which traffic consistently moves at a rate closer to the speed limit. Belkin's N1 MIMO technology helps traffic move at the speed limit and opens more lanes—to become the superhighway in this example. The rate of traffic flow is multiplied by the number of lanes that are opened.

Placement of your Router

Important Factors for Placement and Setup

Your wireless connection will be stronger the closer your computer is to your Router. Typical indoor operating range for wireless devices is between 100 and 200 feet.

In the same way, your wireless connection and performance will degrade somewhat as the distance between your Router and connected devices increases. This may or may not be noticeable to you. As you move further from your Router, connection speed may decrease. Factors that can weaken signals simply by getting in the way of your network's radio waves are metal appliances or obstructions, and walls.

If you have concerns about your network's performance that might be related to range or obstruction factors, try moving the computer to a position between five and 10 feet from the Router in order to see if distance is the problem. If difficulties persist even at close range, please contact Belkin Technical Support.

Note: While some of the items listed below can affect network performance, they will not prohibit your wireless network from functioning; if you are concerned that your network is not operating at its maximum effectiveness, this checklist may help.

1. Router Placement

Place your Router, the central connection point of your network, as close as possible to the center of your wireless network devices.

To achieve the best wireless network coverage for your "wireless clients" (i.e., computers enabled by Belkin Wireless Notebook Network Cards, Wireless Desktop Network Cards, and Wireless USB Adapters):

- Ensure that your Router's networking antennas are parallel to each other, and are positioned vertically (toward the ceiling). If your Router itself is positioned vertically, point the antennas as much as possible in an upward direction.
- In multistory homes, place the Router on a floor that is as close to the center of the home as possible. This may mean placing the the Router on an upper floor.
- Try not to place the the Router near a cordless 2.4GHz phone.

2. Avoid Obstacles and Interference

Avoid placing your Router near devices that may emit radio "noise," such as microwave ovens. Dense objects that can inhibit wireless communication include:

- Refrigerators
- Washers and/or dryers
- Metal cabinets
- Large aquariums
- Metallic-based, UV-tinted windows

If your wireless signal seems weak in some spots, make sure that objects such as these are not blocking the signal's path (between your computers and Router).

3. Cordless Phones

If the performance of your wireless network is impaired after attending to the above issues, and you have a cordless phone:

- Try moving cordless phones away from your Router and your wireless-enabled computers.
- Unplug and remove the battery from any cordless phone that operates on the 2.4GHz band (check manufacturer's information). If this fixes the problem, your phone may be interfering.
- If your phone supports channel selection, change the channel on the phone to the farthest channel from your wireless network. For example, change the phone to channel 1 and move your Router to channel 11. See your phone's user manual for detailed instructions.
- If necessary, consider switching to a 900MHz or 5GHz cordless phone.

4. Choose the "Quietest" Channel for your Wireless Network

In locations where homes or offices are close together, such as apartment buildings or office complexes, there may be wireless networks nearby that can conflict with yours.

Use the Site Survey capabilities found in the Wireless Utility of your wireless adapter to locate any other wireless networks that are available (see your wireless adapter's user manual), and move your Router and computers to a channel as far away from other networks as possible.

- Experiment with more than one of the available channels, in order to find the clearest connection and avoid interference from neighboring cordless phones or other wireless devices.
- For Belkin wireless networking products, use the detailed Site Survey and wireless channel information included with your wireless network card. See your network card's user guide for more information.

These guidelines should allow you to cover the maximum possible area with your Router. Should you need to cover an even wider area, we suggest the Belkin Wireless Range Extender/Access Point.

5. Secure Connections, VPNs, and AOL

Secure connections typically require a user name and password, and are used where security is important. Secure connections include:

- Virtual Private Network (VPN) connections, often used to connect remotely to an office network
- The “Bring Your Own Access” program from America Online (AOL), which lets you use AOL through broadband provided by another cable or ADSL service
- Most online banking websites
- Many commercial websites that require a user name and password to access your account

Secure connections can be interrupted by a computer’s power management setting, which causes it to “go to sleep.” The simplest solution to avoid this is to simply reconnect by rerunning the VPN or AOL software, or by re-logging into the secure website.

A second alternative is to change your computer’s power management settings so it does not go to sleep; however, this may not be appropriate for portable computers. To change your power management setting under Windows, see the “Power Options” item in the Control Panel.

If you continue to have difficulty with Secure Connections, VPNs, and AOL, please review the steps above to be sure you have addressed these issues.

Product Overview

Product Features

In minutes you will be able to share your Internet connection and network your computers. The following is a list of features that make your new Belkin Router an ideal solution for your home or small office network.

Works with Both PCs and Mac® Computers

The Router supports a variety of networking environments including Mac OS® X v10.4, v10.5; Windows® 2000, XP, or Vista®; and others. All that is needed is an Internet browser and a network adapter that supports TCP/IP (the standard language of the Internet).

Interactive Display

The interactive display on the front of the Router indicates which features are in operation. You'll know at-a-glance whether your Router is connected to the Internet. This feature eliminates the need for advanced software and status-monitoring procedures typically needed through the use of a computer.

Web-Based Advanced User Interface

You can set up the Router's advanced functions easily through your web browser, without having to install additional software onto the computer. There are no disks to install or keep track of and, best of all, you can make changes and perform setup functions from any computer on the network quickly and easily.

NAT IP Address Sharing

Your Router employs Network Address Translation (NAT) to share the single IP address assigned to you by your Internet Service Provider (ISP) while saving the cost of adding additional IP addresses to your Internet service account.

SPI Firewall

Your Router is equipped with a firewall that will protect your network from a wide array of common hacker attacks including IP Spoofing, Land Attack, Ping of Death (PoD), Denial of Service (DoS), IP with zero length, Smurf Attack, TCP Null Scan, SYN flood, UDP flooding, Tear Drop Attack, ICMP defect, RIP defect, and fragment flooding.

Product Overview

1

2

3

4

5

6

7

8

9

10

section

Integrated 10/100 4-Port Switch

The Router has a built-in, four-port network switch to allow your wired computers to share printers, data and MP3 files, digital photos, and much more. The switch features automatic detection so it will adjust to the speed of connected devices. The switch will transfer data between computers and the Internet simultaneously without interrupting or consuming resources.

Universal Plug and Play (UPnP)

UPnP is a technology that offers seamless operation of voice messaging, video messaging, games, and other applications that are UPnP-compliant.

Support for VPN Pass-Through

If you connect to your office network from home using a VPN connection, your Router will allow your VPN-equipped computer to pass through the Router and to your office network.

Built-In Dynamic Host Configuration Protocol (DHCP)

Built-In Dynamic Host Configuration Protocol (DHCP) on-board makes for the easiest possible connection of a network. The DHCP server will assign IP addresses to each computer automatically so there is no need for a complicated networking setup.

Belkin Troubleshooting Assistant CD

The Troubleshooting Assistant software takes the guesswork out of setting up your Router. This software automatically determines your network settings for you and sets up the Router for connection to your ISP. In a matter of minutes, your Router will be up and you will be surfing the Internet.

Note: Troubleshooting Assistant software is compatible with Windows 2000, XP, and Vista; and Mac OS X v10.4 and v10.5. If you are using another operating system, the Router can be set up using the Alternate Setup Method described in this User Manual (see page 34).

Integrated N1 Wireless Access Point

N1 MIMO is an exciting new wireless technology based on the draft IEEE 802.11n specification. It employs MIMO (Multiple Input Multiple Output) smart-antenna technology that achieves data rates of up to 300Mbps.* Actual throughput is typically lower than the connected data rate and will vary depending on your networking environment.

***NOTE:** The standard transmission rate—300Mbps—is the physical data rate. Actual data throughput will be lower.

MAC Address Filtering

For added security, you can set up a list of MAC addresses (unique client identifiers) that are allowed access to your network. Every computer has its own MAC address. Simply enter these MAC addresses into a list using the Web-Based Advanced User Interface and you can control access to your network.

Knowing your Router

1

2

3

section

4

5

6

7

8

9

10

Package Contents

- Belkin N1 Vision Wireless Modem Router
- Quick Installation Guide
- Belkin Assistant CD with User Manual
- RJ45 Ethernet Networking Cable
- RJ11 Telephone Cord
- ADSL (Asymmetric Digital Subscriber Line) Microfilter*
- Power Supply

*ADSL microfilter varies by country. If it's not included, you will need to purchase one.

System Requirements

- An active ADSL service with a telephone wall jack for connecting the Router
- At least one computer with an installed network interface adapter
- TCP/IP networking protocol installed on each computer
- No other DHCP server on your local network assigning IP addresses to computers and devices
- Internet browser

Assistant Software System Requirements

- A PC running Windows 2000, XP, or Vista; or Mac OS X v10.x
- Minimum 1GHz processor and 512MB RAM
- Internet browser

Internet Connection Settings

The Setup Assistant contains a database of Internet Service Providers (ISPs) in each country to help you set up your Router quickly. If your ISP is not on the list, please collect the following information from your ISP before setting up the Router:

- Internet connection protocol: _____ (PPPoE, PPPoA, Dynamic IP, Static IP)
- Multiplexing method or encapsulation: _____ (LLC or VC MUX)
- Virtual circuit: VPI (Virtual Path Identifier) _____
(a number between 0 and 255)
- VCI (Virtual Channel Identifier) _____
(a number between 1 and 65535)
- For PPPoE and PPPoA users: ADSL account user name _____ and password _____
- For static IP users: IP Address ____ . ____ . ____ . ____
Subnet Mask ____ . ____ . ____ . ____
Default Gateway Server ____ . ____ . ____ . ____
- IP address for Domain Name Server ____ . ____ . ____ . ____
(If given by your ISP)

Knowing your Router

Hardware Characteristics

The Router has been designed to be placed on a desktop. All of the cables exit from the BACK of the Router for better organization and utility. The Router's interactive display is easily visible on the FRONT of the Router to provide you with information about network activity and status.



Knowing your Router

A. Interactive Display

The interactive display is on the front of the Router, which indicates which features are in operation.

B. 4-Way Keypad

The keypad enables the movement of the up, down, left, and right function that may apply to the screen shown in the interactive display.

C. OK Button

For most screens in the interactive display, the “OK” button will activate the desired feature.

D. Menu Button

Pushing this button will take you back to the Menu Screen within the interactive display.

1

2

3

4

5

6

7

8

9

10

section

Knowing your Router

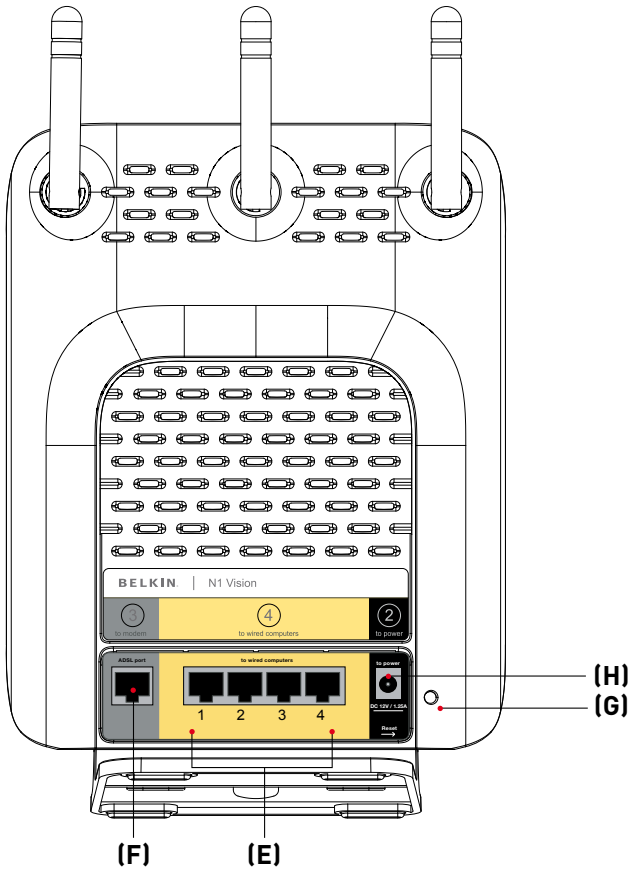

E. Connections to Wired Computers – Yellow Ports

Connect your wired (non-wireless) computers to these ports. These ports are RJ45, 10/100/1000 auto-negotiation, auto-uplinking ports for standard UTP category 5 or 6 Ethernet cable. The ports are labeled 1 through 4. Use the gray cable provided to connect your computer to any one of these ports.

F. Connection to ADSL – Gray Port

This port is for connection to your ADSL. Connect your ADSL to this port. An RJ11 telephone cord is provided in the package.

G. Reset Button

The “Reset” button is used in rare cases when the Router may function improperly. Resetting the Router will restore the Router’s normal operation while maintaining the programmed settings. You can also restore the factory default settings by using the “Reset” button. Use the restore option in instances where you may have forgotten your custom password.

i. Resetting the Router

Push and release the “Reset” button. The lights on the Router will momentarily flash. The “Power/Ready” light will begin to blink. When the “Power/Ready” light becomes solid again, the reset is complete.

ii. Restoring the Factory Defaults

Press and hold the “Reset” button for at least 10 seconds, then release it. The lights on the Router will momentarily flash. The “Power/Ready” light will begin to blink. When the “Power/Ready” light becomes solid again, the restore is complete.

H. Power Jack – Black

Connect the included 12V/1.25A DC power supply to this jack.

Connecting and Configuring your Router

Verify the contents of your box.

You should have the following:

- Belkin N1 Vision Wireless Modem Router
- Quick Installation Guide
- Belkin Assistant CD with User Manual
- RJ45 Ethernet Networking Cable
- RJ11 Telephone Cord
- Power Supply

Connecting and Configuring your Router

Step 1 Hardware Connections – Follow the Quick Installation Guide

1.1 Brand-New Setup

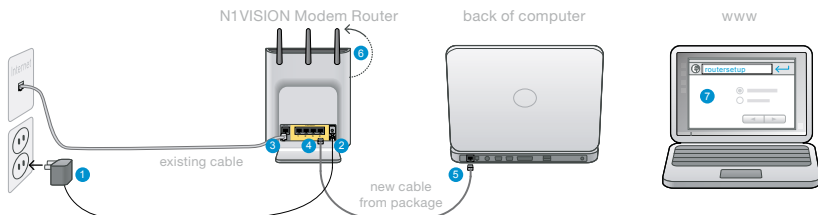

Follow these steps if you are not replacing an existing modem. If you are replacing an existing modem, skip to the next section, “Replacing an Existing Modem or Modem Router”.

1. Unpack your new Router from the box and place it next to your computer. Raise the Router’s antennas.
2. Retrieve the gray RJ45 cable that was included with your Router. First, connect one end to any gray port labeled “to Wired Computers” on the back of your Router. Then, connect the other end to the networking port on the back of your computer.
3. Retrieve the included gray RJ11 phone cord. Connect one end to the yellow port labeled “to ADSL” on the back of your Router. Then connect the other end to your ADSL connection (either a wall jack or an ADSL splitter).

NOTE: Some ADSL connections require a microfilter. Your ADSL provider can tell you if you need one. Belkin includes a microfilter in regions known to use them. You may or may not have received one in your box.

4. Plug your Router’s power supply into the black port labeled “Power” on the back of your Router.
5. Wait 20 seconds for the Router to start up. Look at the display on the front of the Router. Make sure the “Wired” and “Modem-Router” icons are lit up in blue. If they are not, recheck your connections.

Connecting and Configuring your Router

1.2 Replacing an Existing Modem or Modem Router

Follow these steps if you currently have a modem or modem router that you will be replacing with your new Router.

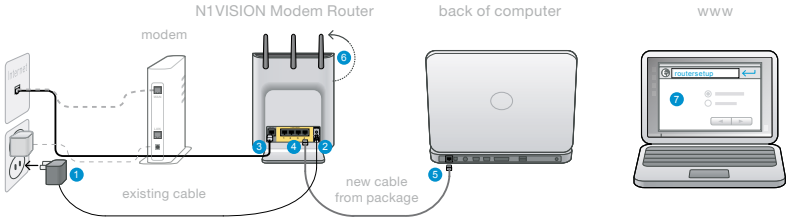

1. Plug the power supply into the wall outlet.
2. Plug the other end into the black port on the Router.
3. Locate the cable that connects your old modem to the ADSL wall jack. Unplug it from your old modem and then connect it to the gray port labeled “ADSL” on the back of your Router.
4. Locate the cable that connects your old modem to the ADSL wall jack. Unplug it from your old modem and then connect it to the gray port labeled “ADSL” on the back of your new Router.
5. Rotate the antennas up.
6. Open a web browser on that computer. The Belkin Router Setup Wizard should appear automatically. If it doesn't, enter “routersetup” into the web-address field and press the “Enter” key.

1

2

3

4

5

6

7

8

9

10

section

Connecting and Configuring your Router

Step 2 | Set Up the Router – Using the Plug-and-Play Router Setup



1. Open a web browser on that computer. The Belkin Router Setup Wizard should appear automatically. If it doesn't, enter "router setup" into the web-address field and press the "Enter" key on your keyboard.



2. The Belkin plug-and-play Setup Wizard should automatically appear. Verify that you have completed all QIG steps by clicking "Begin" to continue.



3. Select the country you are located in by using the drop-down box. Click "Next" to continue.



4. Select your Internet Service Provider (ISP) by using the drop-down box. Click "Next" to continue.

Connecting and Configuring your Router



- 5. If your Internet account requires a user name and password, you will be taken to the screen below to enter this information. Click "Next" to save and continue.



- 6. If your Internet account requires VPI and VCI settings, you will be taken to this screen to enter this information. Click "Next" to save and continue.



- 7. The Router will now check for your Internet connection.



- 8. You will see the Congratulations screen when your Router can connect to the Internet. You have finished installing your new Belkin Router and can begin surfing by opening another browser and going to any website. You may also choose to change your network name, set up a wireless security key, or enable the guest mode from this screen.

Options

- 1. Network Name – This is the name of the Router.
- 2. Network Key Create a wireless security WPA key by typing any 8 to 63 alphanumeric characters in length. Any wireless devices will need this key to connect to the Router.
- 3. Guest Mode – When enabled, this mode will create a new network to which guest users can connect that will separate them from access to your other network and connected devices.

Connecting and Configuring your Router

Interactive Display

The Router's interactive display is a powerful instrument for viewing your network information. The display can provide essential router-status information such as the state of the Internet connection to details such as each device usage and speed of the Internet connection. Within the numerous features of the display, there are also built-in help guides and tips for troubleshooting.



Startup Screen

Once the Router has been plugged in, the "Startup" screen will appear to indicate that the Router is currently in the boot-up state.

Information Screens

After the Router has finished starting up and the plug-and-play Router Setup process has been completed, the first in a series of informational screens will appear. These screens let you view your network status. Push the right key (>) or the left key (<) to cycle through them. The following outlines the details on each.

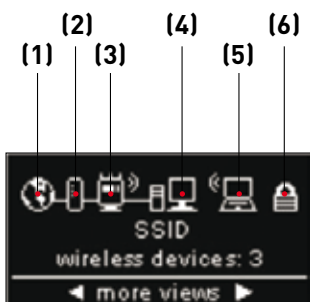

A. Network Status

The "Network Status" screen displays the state of the Router.

1. Internet Connection

This icon shows you when the Router is connected to the Internet.

OFF	No Internet connection has been detected
Solid White	Router is connected to the Internet
Blinking White	Internet connection was detected; Router is not currently able to connect to the Internet

2. ADSL Connection

This icon shows you when the Router is connected to the ADSL line.

OFF	Not connected to the ADSL line
Solid White	Router is connected to ADSL line and functioning properly
Blinking White	Problem with ADSL connection (such as physical connection failure, etc.)

3. Router Wireless State

This icon indicates whether or not wireless is enabled.

Router showing wireless connection (with curved-lines illustration)	Router is ON with wireless enabled and ready for use with wireless and wired
Router showing wired connection (without curved-lines illustration)	Router is ON with wireless disabled and ready for use with only wired devices

4. Wired Computers

This icon indicates if there are any wired connections present.

OFF	Wired device not present
Solid White	Wired device(s) connected to the Router

Connecting and Configuring your Router

5. Wireless Computers

This icon represents if there are any wireless connections present.

OFF	Wireless device is not present
Solid White	Wireless device(s) is connected to the Router

6. Security

This icon indicates wireless security.

OFF	Wireless security is OFF
Solid White	Wireless security is ON



B. Broadband Download Speedometer

This screen will display the current download speed being transferred through the Internet connection. The speed will be measured on the speedometer against the fastest speed that has been measured by the Router since being activated.

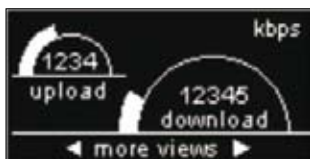

C. Broadband Upload/Download Speedometer

This screen will display the current upload and download speed being transferred through the Internet connection. The speed will be measured on the speedometer against the fastest speed that has been measured by the Router since being activated.



D. Connections/Speed

This screen displays all devices currently connected to the Router and the speed of the broadband data that is being downloaded or uploaded per each device.

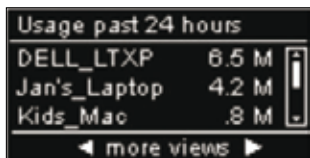

E. Usage Past 24 Hours

This screen displays all devices currently connected to the Router and their broadband usage over a period of 24 hours.

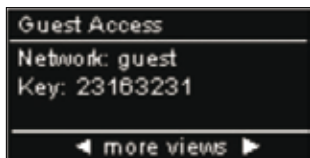

F. Guest Access Status

This screen indicates whether Guest Access is enabled or disabled. For more information on the Guest-Access feature, please see the “Using the Web-Based Advanced User Interface” section in this User Manual.



G. Date & Time

This screen displays the date and time. To toggle between standard and military time, push the up or down key.

Connecting and Configuring your Router

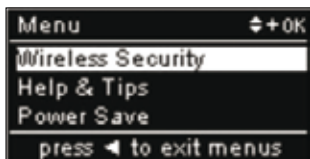

Menu Screen

Push the “Menu” button to open the display’s Menu options. The Menu option allows you to enable features within the Router. The following outlines the details of each feature within the Menu section.

A. Wireless Security

Select Wireless Security by pressing the “OK” button to view these options. From the Wireless Security options, the choices available are listed below.

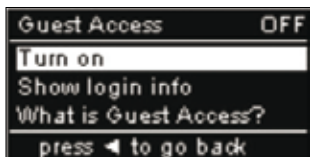

Guest Access – Select this option to enable a separate network to allow guests to connect to the Internet while keeping them away from accessing your network, computers, and private files.

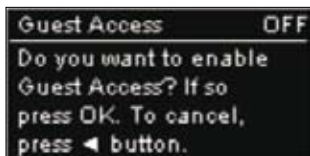

Select “Turn On” to enable Guest Access. To enable the Guest-Access mode, you will need to enable Wi-Fi Protected Access™ (WPATM) on your private network first. To do so, please see the “Setting WPA Security” section in this User Manual.

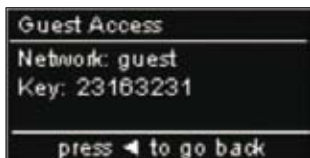

To view the Guest Access network name and password, select the “Show login info” option.



Push Button Security – Select this option if you would like to set up your computers or devices using the Wi-Fi Protected Setup™ (WPS) standard. Using WPS is not a requirement to connect to the Router.

Connecting and Configuring your Router



To make a WPS connection, select the “New Connection” option. To do so, you must have WPS enabled on the computer or device connecting to the Router. You will need to push the WPS button in your computer or device within two minutes.

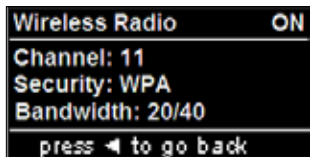

B. Wireless Radio

Disable Wireless – Select this option if you would like to disable the wireless connection. This will essentially end all wireless connections to the Router.

Show info – Select this option to display wireless information for channel, security, and bandwidth settings.

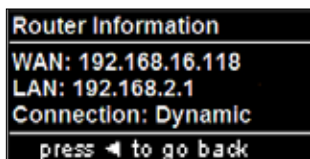

C. Router Information

This option shows IP address and connection-type settings.

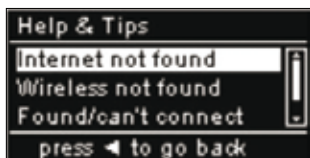

D. Help and Tips

Select this option for additional information.

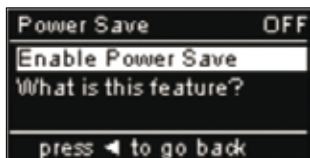

E. Power Save

Select this option to conserve the display's power or if you prefer to turn off graphics. When power save is ON, the display will turn off within two minutes after any user interaction.

1

2

3

4

5

6

7

8

9

10

section

Connecting and Configuring your Router

Troubleshooting Assistant CD

Belkin has provided our Assistant software to make installing your Router a simple and easy task. You can use it to get your Router up and running in minutes. The Assistant software requires that your Windows 2000, XP, or Vista computer be connected directly to your ADSL modem and that the Internet connection is active and working at the time of installation. If it is not, you must use the “Alternate Setup Method” section in this User Manual to configure your Router. Additionally, if you are using an operating system other than Windows 2000, XP, or Vista, you must set up the Router using the “Alternate Setup Method” section in this User Manual.

- A. Shut down any programs that are running on your computer at this time.

Turn off any firewall or Internet-connection-sharing software on your computer.

- B. Insert the CD into your computer. The Troubleshooting Assistant will automatically appear on your computer’s screen within 15 seconds. Click on “Go” to run the Troubleshooting Assistant. Follow the instructions there.

IMPORTANT: Run the Setup Assistant from the computer that is directly connected to the Router from Step 1.1B.

Connecting and Configuring your Router



Note for Windows Users: If the Setup Assistant does not start up automatically, select your CD-ROM drive from “My Computer” and double-click on the file named “Setup.exe” to start the Setup Assistant.



Select Country

Select your country from the drop-down box. Click “Begin” to continue.



Confirmation Screen

Verify that you have completed all QIG steps by checking the box to the right of the arrow. Click “Next” to continue.



Progress Screen

Setup Assistant will show you a progress screen each time a step in the setup has been completed.



2.1 Checking Settings

The Setup Assistant will now examine your computer’s network settings and gather information needed to complete the Router’s connection to the Internet.

1

2

3

4

5

6

7

8

9

10

section

Connecting and Configuring your Router



2.2 Verifying Hardware Connections

The Setup Assistant will now verify your hardware connection.



2.3 Naming your Wireless Network

The Setup Assistant will display the default wireless network name or Service Set Identifier (SSID). This is the name of your wireless network to which your computers or devices with wireless network adapters will connect. You can either use the default or change it to something unique. Write down this name for future reference. Click "Next" to continue.



2.4 Requesting Internet Account Info (if needed)

Select your ISP from the drop-down boxes.



If your Internet account requires a login and password, you will be prompted with a screen similar to the illustration below. Click “Next” to continue.



2.5 Configuring the Router

The Setup Assistant will now configure your Router by sending data to the Router and restarting it. Wait for the on-screen instructions.

Note: Do not disconnect any cable or power off the Router while it is rebooting. Doing so will render your Router inoperable.

1

2

3

4

5

6

7

8

9

10

Connecting and Configuring your Router



2.6 Checking Internet Connection

We are almost done. The Setup Assistant will now check your connection to the Internet.



Congratulations

You have finished installing your new Router. You will see the Congratulations screen when your Router can connect to the Internet. You can begin surfing by opening your browser and going to any website.

You can use the Setup Assistant to set up your other wired and wireless computers to connect to the Internet by clicking “Next”. If you decide to add computers to your Router later, select “Finish—return to Main Menu” and then click “Next”.



Troubleshooting

If the Setup Assistant is not able to connect to the Internet, you will see the following screen. Follow the on-screen instructions to go through the troubleshooting steps.



2.7 Optional: Assistance Connecting Other Computers

This optional step will help you to connect additional wired and wireless computers to your network. Follow the on-screen instructions.



Once you have verified that your other wired and wireless computers are properly connected, your network is set up and working. You can now surf the Internet. Click "Next" to return to the main menu.

1

2

3

4

5

6

7

8

9

10

section

Connecting and Configuring your Router

Step 3 | Set Up Wireless Security – Run the Security Assistant Software

Now that your network is set up and working, it is recommended that you turn on wireless security to prevent unauthorized access to your network from neighboring wireless-enabled computers. The Security Assistant will guide you through the process. Click “Security Assistant” and follow the on-screen instructions.

IMPORTANT: Run the Setup Assistant from the computer that is directly connected to the Router from Steps 1.1B and 1.2B.



Progress Screen

The Security Assistant will show you a progress screen each time a step has been completed.



3.1 Picking the Security Type

Select the security type for your wireless network and click “Next” to continue.



3.2 Creating a Network Key
Enter a network key (PSK) for your wireless network and click “Next” to continue.



3.3 Transferring the Key
After setting up your wireless security, you will have to transfer the network key to each of your wireless computers. Click on “Transfer Key” if you have a USB flash drive. Follow the on-screen instructions, or click on “Print” to print the information. Manually enter it into each wireless computer. Then, click “Next” to continue.



3.4 Verifying the Connection
If all your wireless computers are able to connect to the Router, click “Next”. If you are having trouble, select “I had problems with at least one computer” and click “Next”. Then, follow the on-screen instructions.



Congratulations
Once you have verified that your wireless computers are properly connected, your wireless network is set up and secured. You now can run your network wirelessly and securely. Click “Finish” to take you back to the main menu.

Alternate Setup Method

Step 1 Hardware Connections – Follow the Quick Installation Guide (QIG)

See the QIG or Step 1: Hardware Connections from the previous section.

Step 2 Set your Computer's Network Settings to Work with a DHCP Server

See the section in this User Manual called “Manually Configuring Network Settings” for directions.

Step 3 Configuring the Router Using the Web-Based Advanced User Interface

Using your Internet browser, you can access the Router's Web-Based Advanced User Interface. In your browser, type “192.168.2.1” (do not type in anything else such as “http://” or “www”). Then press the “Enter” key.

Address	192.168.2.1
---------	-------------

Alternate Setup Method

Logging into the Router

You will see the Router's home page in your browser window. The home page is visible to any user who wants to see it. To make any changes to the Router's settings, you have to log in. Clicking the "Login" button or clicking on any one of the links on the home page will take you to the login screen. The Router ships with no password entered. In the login screen, leave the password blank and click the "Submit" button to log in.

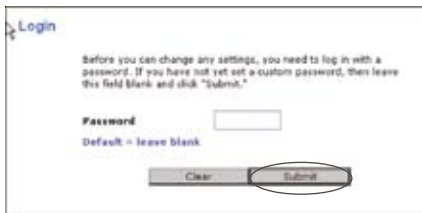

Logging out of the Router

One computer at a time can log into the Router for the purposes of making changes to the settings of the Router. Once a user has logged in to make changes, there are two ways that the computer can be logged out. Clicking the "Logout" button will log the computer out. The second method is automatic. The login will time out after a specified period of time. The default login time-out is 10 minutes. This can be changed from one to 99 minutes. For more information, see the section in this manual titled "Changing the Login Time-Out Setting".

Understanding the Web-Based Advanced User Interface

The home page (shown on the next page) is the first page you will see when you access the Advanced User Interface (UI). The home page shows you a quick view of the Router's status and settings. All advanced setup pages can be reached from this page.

1

2

3

4

5

6

7

8

9

10

section

Alternate Setup Method

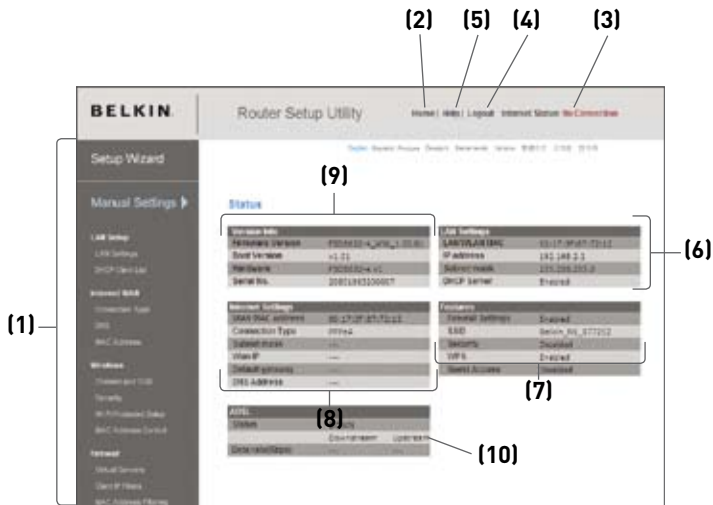

1. Quick-Navigation Links

You can go directly to any of the Router's advanced UI pages by clicking directly on these links. The links are divided into logical categories and grouped by tabs to make finding a particular setting easier to find. Clicking on the purple header of each tab will show you a short description of the tab's function.

2. Home Button

The home button is available in every page of the UI. Pressing this button will take you back to the home page.

3. Internet-Status Indicator

This indicator is visible in all pages of the Router, indicating the connection status of the Router. When the indicator says "Connected" in blue, the Router is connected to the Internet. When the Router is not connected to the Internet, the indicator will read "No Connection" in RED. The indicator is automatically updated when you make changes to the settings of the Router.

4. Login/Logout Button

This button enables you to log in and out of the Router with the press of one button. When you are logged into the Router, this button will change to read “Logout”. Logging into the Router will take you to a separate login page where you will need to enter a password. When you are logged into the Router, you can make changes to the settings. When you are finished making changes, you can log out of the Router by clicking the “Logout” button. For more information about logging into the Router, see the section called “Logging into the Router”.

5. Help Button

The “Help” button gives you access to the Router’s help pages. Help is also available on many pages by clicking “more info” next to certain sections of each page.

6. LAN Settings

Shows you the settings of the Local Area Network (LAN) side of the Router. Changes can be made to the settings by clicking on any one of the links (IP Address, Subnet Mask, DHCP Server) or by clicking the “LAN” quick-navigation link on the left side of the screen.

7. Features

Shows the status of the Router’s NAT, firewall, and wireless features. Changes can be made to the settings by clicking on any one of the links or by clicking the quick-navigation links on the left side of the screen.

8. Internet Settings

Shows the settings of the Internet/WAN side of the Router that connects to the Internet. Changes to any of these settings can be made by clicking on the links or by clicking on the “Internet/WAN” quick-navigation link on the left side of the screen.

9. Version Info

Shows the firmware version, boot-code version, hardware version, and serial number of the Router.

10. ADSL Info

Shows the ADSL status and transmission rates.

1

2

3

4

5

6

7

8

9

10

section

Alternate Setup Method

Step 4 Configuring your Router for Connection to your Internet Service Provider (ISP)

The “Internet/WAN” tab is where you will set up your Router to connect to your Internet Service Provider (ISP). The Router is capable of connecting to virtually any ISP’s system provided you have correctly configured the Router’s settings for your ISP’s connection type. Your ISP connection settings are provided to you by your ISP. To configure the Router with the settings that your ISP gave you, click “Connection Type” **(A)** on the left side of the screen. Select the connection type you use. If your ISP gave you DNS settings, clicking “DNS” **(B)** allows you to enter DNS address entries for ISPs that require specific settings. Clicking “MAC Address” **(C)** will let you clone your computer’s MAC address or type in a specific WAN MAC address, if required by your ISP. When you have finished making settings, the “Internet Status” indicator will read “connection OK” if your Router is set up properly.

BELKIN Router Setup Utility [Home](#) | [Help](#) | [Logout](#) Internet Status: **No Connection**

Setup Wizard

Manual Settings ▶

(A) → LAN Setup

(B) → Internet WAN

(C) → Wireless

Internet WAN >

The Internet(WAN) Tab is where you will set up your Router to connect to your Internet Service Provider. The Router is capable of connecting to virtually any Internet Service Provider's system provided that you have correctly configured the Router's settings for your ISP's connection type. To configure the Router to connect to your ISP, click on "Connection type" on the Internet(WAN) Tab on the left of the screen.

- PPPoE
- PPPoA
- Dynamic Fixed IP (1483 Bridged)
- Static IP (PNA)
- Modem Only (Disable Internet Sharing)

Connection Type

From the “Connection Type” page, you can select one of these five connection types based on the instruction provided by your ISP:

- PPPoE
- PPPoA
- Dynamic/Fixed IP (1483 Bridged)
- Static IP (IPoA)
- Modem Only (Disable Internet Sharing)

Select the type of connection you use by clicking the radio button **(1)** next to your connection type and then clicking “Next” **(2)**.

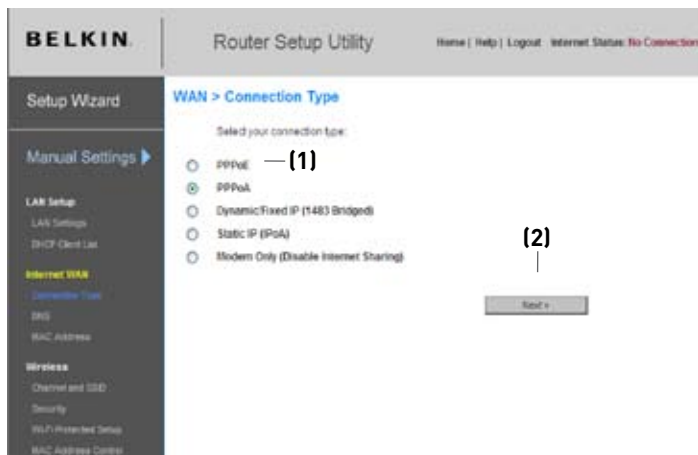

Alternate Setup Method

Setting your ISP Connection Type to PPPoE or PPPoA

PPPoE (Point-to-Point Protocol over Ethernet) is the standard method of connecting networked devices. It requires a user name and password to access the network of your ISP for connecting to the Internet. PPPoA (PPP over ATM) is similar to PPPoE, but is mostly implemented in the UK. Select PPPoE or PPPoA and click “Next”. Then enter the information provided by your ISP, and click “Apply Changes” to activate your settings.

BELKIN Router Setup Utility Home | Help | Logout Internet Status: No Connection

Setup Wizard WAN > Connection Type > PPPoE

To enter your PPPoE settings, type in your information below and click "Apply changes". [More Info](#)

User Name > [] (1)

Password > [] (2)

Retype Password > [] (3)

Service Name (Optional) > [] (4)

VPI / VCI > [0] / [30] (5)

Encapsulation > [LLC] (6)

MTU (576-1492) > [1454] (7)

Do not make changes to the MTU setting unless your ISP specifically requires a different setting than 1454. [More Info](#)

Disconnected after [5] minutes of no activity [More Info](#)

(8)

Clear Changes Apply Changes

1. User Name – Enter the user name. (Assigned by your ISP)

2. Password – Enter your password. (Assigned by your ISP)

3. Retype Password – Confirm the password.
(Assigned by your ISP)

4. Service Name – Enter a service name (optional).

5. VPI/VCI – Enter your Virtual Path Identifier (VPI) and Virtual Circuit Identifier (VCI) parameter here. (Assigned by your ISP)

Alternate Setup Method

6. Encapsulation – Select your encapsulation type here.
(Supplied by your ISP)

VC-MUX: PPPOA Virtual Circuit Multiplexer (null encapsulation) allows only one protocol running per virtual circuit with fewer overheads.

LLC: PPPoA Logical Control allows multiple protocols running over one virtual circuit (more overhead).

7. MTU – Enter the MTU value for your ISP.

8. Disconnect after x minutes of no activity – Check the box and enter the number of minutes when you want the Router to auto-disconnect after no activity. After this time has been exceeded, the connection will be terminated.

Click “Apply Changes” to save and activate your settings. To go back to the original settings before saving, click “Clear Changes”; or click any of the quick-navigation links for other options. Your new settings will not be saved unless you click “Apply Changes”.

1

2

3

4

5

6

7

8

9

10

section

Alternate Setup Method

Setting your Connection Type to Dynamic/Fixed IP (1483 Bridged)

This connection method bridges your network and ISP's network together. The Router can obtain an IP address automatically from your ISP's DHCP server or accept a fixed IP address assigned by your ISP.

For Dynamic IP connection:

1. **IP Assigned by ISP** – Select “Yes” if your ISP instructed you to use a fixed IP.
2. **Host Name** – Enter a host name.
3. **VPI/VCI** – Enter your VPI and VCI parameter here. These identifiers are assigned by your ISP.
4. **Encapsulation** – Select LLC or VC MUX that your ISP uses.

For Fixed IP connection:

1. **IP assigned by ISP** – Select “No” if your ISP instructed you to use a fixed IP.
2. **IP Address** – Enter an IP address assigned by your ISP for the Router's WAN interface.
3. **Subnet Mask** – Enter a subnet mask assigned by your ISP.
4. **Default Gateway** – Enter a default gateway IP address assigned by your ISP.
5. **VPI/VCI** – Enter your Virtual Path Identifier (VPI) and Virtual Circuit Identifier (VCI) parameters here. These identifiers are assigned by your ISP.
6. **Encapsulation** – Select the LLC or VC MUX your ISP uses.

Setting your ISP Connection Type to Static IP (IPoA)

This connection type is also called “Classical IP over ATM” or “CLIP”, which your ISP provides to a fixed IP for your Router to connect to the Internet.

The screenshot shows the Belkin Router Setup Utility interface. The title bar reads "BELKIN Router Setup Utility" with links for Home, Help, Logout, and Internet Status (No Connection). The main navigation sidebar on the left includes "Setup Wizard", "Manual Settings" (with a right-pointing arrow), "LAN Setup" (with sub-links for LAN Settings and DHCP Client List), "Advanced WAN" (highlighted in yellow), "Connection Type" (with a right-pointing arrow), "DNS", "WAN Address", "Wireless" (with sub-links for Wireless LAN, Security, WPA Protected Setup, and WAN Address Control), and "Firewall" (with sub-links for Virtual Servers, Client Filters, and WAN Address Filtering). The main content area is titled "WAN > Connection Type > Static IP(IPoA)" and includes a link for "ATM interface" and "More info". It contains five configuration fields with numbered callouts: (1) IP Address (192.168.1.1), (2) Subnet Mask (255.255.255.0), (3) Default gateway (192.168.1.1), (4) VPI/VCI (0/38), and (5) Encapsulation (VC MUX). At the bottom are "Clear Changes" and "Apply Changes" buttons.

1. IP Address – Enter an IP address assigned by your ISP for the Router’s WAN interface.

2. Subnet Mask – Enter a subnet mask assigned by your ISP.

3. Default gateway – Enter a default gateway IP address. If the Router cannot find the destination address within its local network, it will forward the packets to the default gateway assigned by your ISP.

4. VPI/VCI – Enter your VPI and VCI parameter here. These identifiers are assigned by your ISP.

5. Encapsulation – Select LLC or VC MUX that your ISP uses.

Click “Apply Changes” to save and activate your settings. To go back to the original settings before saving, click “Clear Changes”; or click any of the quick-navigation links for other options. Your new settings will not be saved unless you click “Apply Changes”.

Alternate Setup Method

Setting your Connection Type to Modem Only (Disable Internet Sharing)

In this mode, the Router simply acts as a bridge passing packets across the DSL port. It requires additional software to be installed on your computers in order to access the Internet.

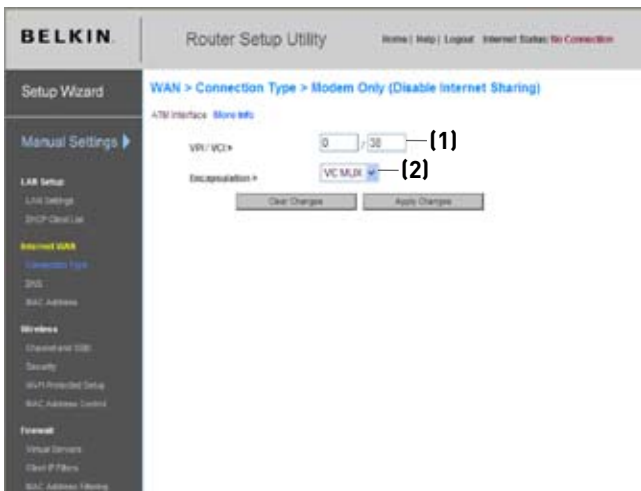

1. VPI/VCI – Enter your VPI and VCI parameter here. These identifiers are assigned by your ISP.

2. Encapsulation – Select the LLC or VC MUX that your ISP uses.

Click “Apply Changes” to save and activate your settings. To go back to the original settings before saving, click “Clear Changes”; or click any of the quick-navigation links for other options. Your new settings will not be saved unless you click “Apply Changes”.

Setting Custom Domain Name Server (DNS) Settings

A “Domain Name Server” is a server located on the Internet that translates Universal Resource Locaters (URLs) like “www.belkin.com” to IP addresses. Many Internet Service Providers (ISPs) do not require you to enter this information into the Router. The “Automatic from ISP” box **(1)** should be checked if your ISP did not give you a specific DNS address. If you are using a static IP connection type, then you may need to enter a specific DNS address and secondary DNS address for your connection to work properly. If your connection type is dynamic or PPPoE, it is likely that you do not have to enter a DNS address. Leave the “Automatic from ISP” box checked. To enter the DNS address settings, uncheck the “Automatic from ISP” box and enter your DNS entries in the spaces provided. Click “Apply Changes” **(2)** to save the settings.

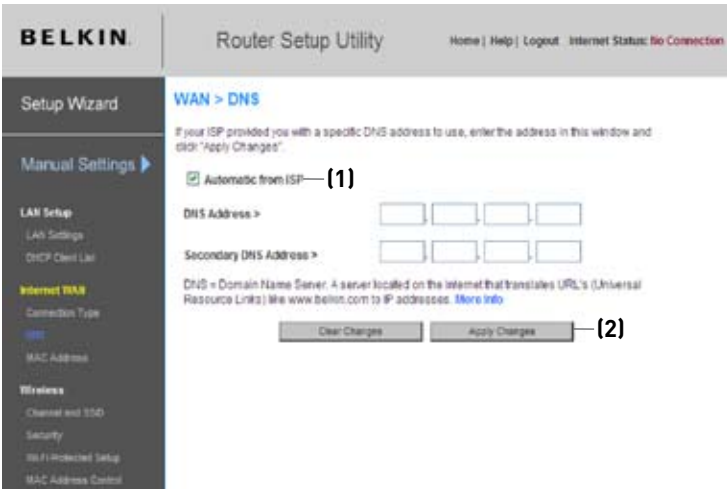

Alternate Setup Method

Configuring your WAN Media Access Controller (MAC) Address

All network components including cards, adapters, and routers, have a unique “serial number” called a MAC address. Your Internet Service Provider (ISP) may record the MAC address of your computer’s adapter and only let that particular computer connect to the Internet service. When you install the Router, its own MAC address will be “seen” by the ISP and may cause the connection not to work. Belkin has provided the ability to clone (copy) the MAC address of the computer into the Router. This MAC address, in turn, will be seen by the ISP’s system as the original MAC address and will allow the connection to work. If you are not sure whether your ISP needs to see the original MAC address, simply clone the MAC address of the computer that was originally connected to the modem. Cloning the address will not cause any problems with your network.

Cloning your MAC Address

To clone your MAC address, make sure that you are using the computer that was **ORIGINALLY CONNECTED** to your modem before the Router was installed. Click the “Clone” button **(1)**. Click “Apply Changes” **(3)**. Your MAC address is now cloned to the Router.

Entering a Specific MAC Address

In certain circumstances you may need a specific WAN MAC address. You can manually enter one in the “MAC Address” page. Type in a MAC address in the spaces provided **(2)** and click “Apply Changes” **(3)** to save the changes. The Router’s WAN MAC address will now be changed to the MAC address you specified.

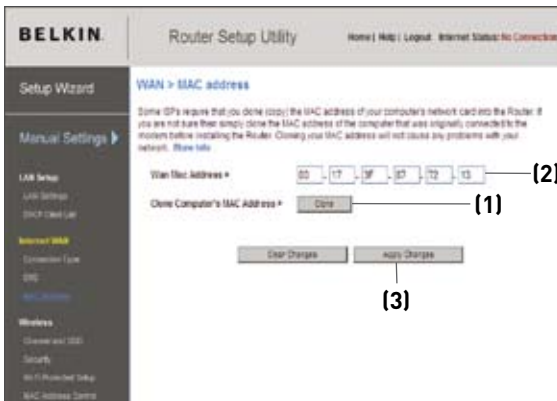

Using the Web-Based Advanced User Interface

Using your Internet browser, you can access the Router's Web-Based Advanced User Interface. In your browser, type "192.168.2.1" (do not type in anything else such as "http://" or "www") then press the "Enter" key.

Address	192.168.2.1
---------	-------------

You will see the Router's home page in your browser window.

Viewing the LAN Settings

Clicking on the header of the LAN tab **(1)** will take you to the LAN tab's header page. A quick description of the functions can be found here. To view the settings or make changes to any of the LAN settings, click on "LAN Settings" **(2)** or to view the list of connected computers, click on "DHCP client list" **(3)**.

(1) BELKIN Router Setup Utility Home | Help | Logout Internet Status: No Connection

Setup Wizard LAN >

Manual Settings ▶

(2) LAN Setup

(3) DHCP Client List

Advanced WAN

Firewall

Miscellaneous

Your Router is equipped with a DHCP server that will automatically assign IP addresses to each computer on your network. The factory default settings for the DHCP server will work in most any application. If you need to make changes to the settings, you can do so.

The changes that you can make are:

- Change the Internal IP address of the Router. The default = 192.168.2.1
- Change the Subnet Mask. The default = 255.255.255.0
- Enable/Disable the DHCP Server Function. Default= On (Enabled)
- Specify the Starting and Ending IP Pool Address. Default = Starting: 2 | Ending: 100
- Specify the IP address Lease Time. Default= Forever
- Specify a local Domain Name. Default = Belkin

To make changes, click 'LAN Settings' on the LAN tab to the left.

The Router will also provide you with a list of all client computers connected to the network. To view the list, click 'DHCP Client List' on the LAN tab to the left.

1

2

3

4

5

6

7

8

9

10

section

Changing LAN Settings

All settings for the internal LAN setup of the Router can be viewed and changed here.

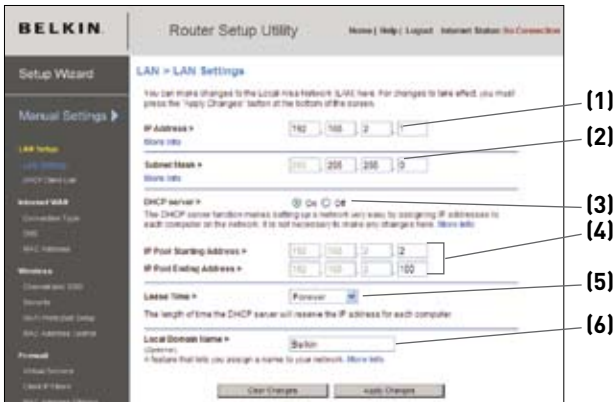

1. IP Address

The “IP address” is the internal IP address of the Router. The default IP address is “192.168.2.1”. To access the advanced setup interface, type this IP address into the address bar of your browser. This address can be changed if needed. To change the IP address, type in the new IP address and click “Apply Changes”. The IP address you choose should be a non-routable IP. Examples of a non-routable IP are:

192.168.x.x (where x is anything between 0 and 255)

10.x.x.x (where x is anything between 0 and 255)

2. Subnet Mask

There is no need to change the subnet mask. This is a unique, advanced feature of your Belkin Router. It is possible to change the subnet mask if necessary; however, do NOT make changes to the subnet mask unless you have a specific reason to do so. The default setting is “255.255.255.0”.

3. DHCP Server

The DHCP server function makes setting up a network very easy by assigning IP addresses to each computer on the network automatically. The default setting is “On”. The DHCP server can be turned OFF if necessary; however, in order to do so you must manually set a static IP address for each computer on your network. To turn off the DHCP server, select “Off” and click “Apply Changes”.

4. IP Pool

The range of IP addresses set aside for dynamic assignment to the computers on your network. The default is 2–100 (99 computers). If you want to change this number, you can do so by entering a new starting and ending IP address and clicking on “Apply Changes”. The DHCP server can assign 100 IP addresses automatically. This means that you cannot specify an IP address pool larger than 100 computers. For example, starting at 50 means you have to end at 150 or lower so as not to exceed the 100-client limit. The starting IP address must be lower in number than the ending IP address.

5. Lease Time

The length of time the DHCP server will reserve the IP address for each computer. We recommend that you leave the lease time set to “Forever”. The default setting is “Forever”, meaning that any time a computer is assigned an IP address by the DHCP server, the IP address will not change for that particular computer. Setting lease times for shorter intervals such as one day or one hour frees IP addresses after the specified period of time. This also means that a particular computer’s IP address may change over time. If you have set any of the other advanced features of the Router such as DMZ or client IP filters, these are dependent on the IP address. For this reason, you will not want the IP address to change.

6. Local Domain Name

The default setting is “Belkin”. You can set a local domain name (network name) for your network. There is no need to change this setting unless you have a specific advanced need to do so. You can name the network anything you want such as “MY NETWORK”.

1

2

3

4

5

6

7

8

9

10

section

Viewing the DHCP Client List Page

You can view a list of the computers (known as clients), which are connected to your network. You are able to view the IP address **(1)** of the computer, the host name **(2)** (if the computer has been assigned one), and the MAC address **(3)** of the computer's network interface card (NIC). Pressing the "Refresh" **(4)** button will update the list. If there have been any changes, the list will be updated.

The screenshot shows the 'Router Setup Utility' interface for a Belkin router. The main content area is titled 'LAN > DHCP Client List'. Below the title, there is a table with three columns: 'IP Address', 'Host Name', and 'MAC Address'. The table contains one row of data: '192.168.2.2', 'DHN14F1', and '3E 1C 23 2E A7 5F'. Below the table is a 'Refresh' button. Callouts (1), (2), (3), and (4) are placed over the IP Address, Host Name, MAC Address, and Refresh button respectively. A small text block above the table explains that the page shows IP addresses, host names, and MAC addresses of computers connected to the network, and that the 'Refresh' button updates the list.

IP Address	Host Name	MAC Address
192.168.2.2	DHN14F1	3E 1C 23 2E A7 5F

Configuring the Wireless Network Settings

The "Wireless" tab lets you make changes to the wireless network settings. From this tab you can make changes to the wireless network name or Service Set Identifier (SSID), operating channel, encryption security settings, and configure the Router to be used as an access point.

Changing the Wireless Network Name (SSID)

To identify your wireless network, a name called the SSID is used. The SSID is your network name. The default network name of the Router is “Belkin N1 Wireless” followed by six digits that are unique to your Router. Your network name will look something like “Belkin_N1_Wireless_123456”. You can change this to anything you choose, or you can leave it unchanged. Keep in mind, if you decide to change your wireless network name, and there are other wireless networks operating in your area, your network name needs to be different from other wireless networks that may be operating in your area. To change the SSID, type in the SSID that you want to use in the SSID field **(1)** and click “Apply Changes” **(2)**. The change is immediate. If you make a change to the SSID, your wireless-equipped computers may also need to be reconfigured to connect to your new network name. Refer to the documentation of your wireless network adapter for information on making this change.



Note: Please periodically check for new Router firmware updates from the “Utilities > Firmware update” page. Newer firmware can fix problems, add wireless features, and/or improve wireless performance (see page 79).

Changing the Wireless Channel

There are a number of operating channels from which you can choose—in the United States, there are 11 and in the United Kingdom (and most of Europe), there are 13. In a small number of other countries, there are other channel requirements. Your Router is configured to operate on the proper channels for the country in which you reside. The channel can be changed if needed. If there are other wireless networks operating in your area, your network should be set to operate on a channel that is different than the other wireless networks.

Using the Wireless Mode Switch

This switch allows you to set the Router's wireless modes. There are several modes.

Note: Some modes may require firmware updates to be enabled.

1) 802.11b+g+n

Setting the Router to this mode will allow 802.11b-, 802.11g-, and 802.11n-compliant devices to join the network.

2) Off

This mode will turn OFF the Router's access point, so no wireless devices can join the network. Turning off the wireless function of your Router is a great way to secure your network when you are away from home for a long period of time, or don't want to use the wireless feature of the Router at a certain time.



Using the Bandwidth Switch

This switch allows you to set the Router's wireless bandwidth modes. There are several modes available:

1) 20MHz only

Setting the Router to this mode allows only 20MHz operation. This mode is compatible with N1, draft 802.11n-, 802.11g-, and 802.11b-compliant devices, but will limit N1, draft 802.11n-compliant devices' bandwidth by half. Reducing bandwidth to 20MHz-only operation might solve some wireless problems.

2) 20MHz/40MHz Auto

Setting the Router to this mode allows it to switch automatically between 20MHz and 40MHz operation. This mode enables 40MHz operation, to maximize speed for N1, draft 802.11n-compliant devices when conditions permit. When a legacy 802.11g access point is presented and occupies an adjacent secondary channel, the Router automatically reverts to 20MHz operation to maximize compatibility. We recommend using this as the default mode.

802.11e QoS

WMM® (Wi-Fi Multimedia™), based on 802.11e QoS (Quality of Service), prioritizes important data on your network, such as multimedia content and voice-over-IP (VoIP), so it will not be interfered with by other data being sent over the network. This feature requires other wireless devices, such as Wi-Fi phones or wireless laptops, to support WMM for best results.

1

2

3

4

5

6

7

8

9

10

Using the Broadcast SSID Feature

Note: This advanced feature should be employed by advanced users only. For security, you can choose not to broadcast your network's SSID. Doing so will keep your network name hidden from computers that are scanning for the presence of wireless networks. To turn off the broadcast of the SSID, remove the check mark from the box next to "Broadcast SSID", and then click "Apply Changes". The change is immediate. Each computer now needs to be set to connect to your specific SSID; an SSID of "ANY" will no longer be accepted. Refer to the documentation of your wireless network adapter for information on making this change.

Protected Mode Switch

Protected mode ensures proper operation of N1, draft 802.11n-compliant devices on your wireless network when 802.11g or 802.11b devices are present or when there is heavy 802.11g or 802.11b traffic in the operating environment. Use protected mode if your network consists of a mix of Belkin N1 Wireless Cards and 802.11g or 802.11b cards on your network. If you are in an environment that includes little to no 802.11g or 802.11b wireless network traffic, you will achieve the best N1 wireless performance with protected mode OFF. Conversely, in an environment with HEAVY 802.11g or 802.11b traffic or interference, you will achieve the best N1 wireless performance with protected mode ON. This will ensure N1 wireless performance is not affected.

Changing the Wireless Security Settings

Your Router is equipped with the latest security standard called Wi-Fi Protected Access™ 2 (WPA2™) and the legacy security standard called Wired Equivalent Privacy (WEP). Your Router also supports the Wi-Fi Protected Setup (WPS) specification, which simplifies the setup of a wireless network. WPS uses familiar methodologies, such as typing in a Personal Identification Number (PIN) or pushing a button, to enable users to automatically configure network names and strong WPA/WPA2 data encryption and authentication. By default, your Router does not ship with security enabled. You may automatically configure the security settings using WPS. To change the security settings manually, you will need to determine which standard you want to use. To access the security settings, click "Security" on the "Wireless" tab.

Using Wi-Fi Protected Setup

WPS uses WPA2 for encryption. It does not provide additional security, but rather, standardizes the method for securing your wireless network. You may use either the Push Button Configuration (PBC) method or PIN method to allow a device access to your wireless network. Conceptually, the two methods work as follows:

PBC: Push the “menu” button on the keypad on the front of the Router. Select “Wireless Security” by pressing the “OK” button. Select “Push Button Security”, followed by the “New Connection” option. Then, initiate the WPS procedure on the client device within two minutes. Refer to your client’s documentation on this procedure. Pushing the PBC button will automatically enable WPS. The client has now been securely added to your wireless network.

PIN: The client device has a PIN number (either four or eight digits) that is associated with WPS. Enable WPS through the screen illustrated below. Enter the client’s PIN into the Router’s internal registrar (accessed through this screen). The client will be automatically enrolled into your wireless network within two minutes.

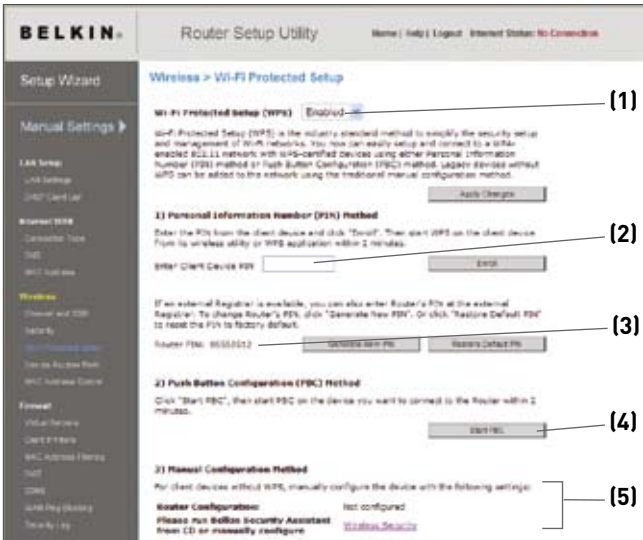

Using the Web-Based Advanced User Interface

1. **Wi-Fi Protected Setup (WPS): Enabled or Disabled.**
2. **Personal Identification Number (PIN) Method:** In this method, a wireless client wishing to access your network must supply a 4- or 8-digit PIN to the Router. After clicking “Enroll”, you must start the WPS handshaking procedure from the client within two minutes.
3. **Router PIN:** If an external registrar is available, you may enter in the Router’s PIN to the registrar. Click “Generate New PIN” to change the PIN from the default value. Click “Restore Default PIN” to reset the PIN value.
4. **Push Button Configuration (PBC) Method:** PBC is an alternate method to connect to a WPS network. Push the PBC button located on the back of the Router for three seconds, and then initiate the PBC on the client device. Alternatively, push the “Start PBC” soft button to start this process.
5. **Manual Configuration Method:** This section lists the default security settings if not using WPS.

The Router features WPA2, which is the second generation of the WPA™ based 802.11i standard. It offers a higher level of wireless security by combining advanced network authentication and stronger Advanced Encryption Standard (AES) encryption methods.

WPA2 Requirements

IMPORTANT: In order to use WPA2 security, all your computers and wireless client adapters must be upgraded with patches, driver, and client utility software that supported WPA2. At the time of this User Manual's publication, a couple security patches are available, for free download, from Microsoft®. These patches work only with the Windows XP operating system. Other operating systems are not supported at this time.

For Windows XP computers that do not have Service Pack 2 (SP2), a file from Microsoft called "Windows XP Support Patch for Wireless Protected Access (KB 826942)" is available for free download at <http://support.microsoft.com/?kbid=826942>

For Windows XP with Service Pack 2, Microsoft has released a free download to update the wireless client components to support WPA2 (KB893357). The update is available from: <http://support.microsoft.com/?kbid=893357>

IMPORTANT: You also need to ensure that all your wireless client cards/adapters support WPA2, and that you have downloaded and installed the latest driver. Most of the Belkin wireless cards have driver updates available for download from the Belkin support site: www.belkin.com/networking.

1

2

3

4

5

6

7

8

9

10

section

Setting WPA/WPA2-Personal (PSK)

Like WPA security, WPA2 is available in both WPA2-Personal (PSK) mode and WPA2-Enterprise (RADIUS) mode. Typically, WPA2-Personal (PSK) is the mode that will be used in a home environment, while WPA2-Enterprise (RADIUS) is implemented in a business environment where an external radius server distributes the network key to the clients automatically. This guide will focus on WPA2-Personal (PSK) usage. Please refer to the User Manual for more information about wireless security and different types of wireless security.

1. After you've set up your Router, go to the "Security" page under "Wireless" and select "WPA/WPA2-Personal (PSK)" from the "Security Mode" drop-down menu.
2. For "Authentication", select "WPA-PSK", "WPA2-PSK", or "WPA-PSK + WPA2-PSK". This setting will have to be identical on the wireless clients that you set up. "WPA-PSK + WPA2-PSK" mode will allow the Router to support clients running either WPA or WPA2 security.
3. Enter your pre-shared key (PSK). This can be from eight to 63 characters and can be letters, numbers, or symbols. This same key must be used on all of the wireless clients that you set up. For example, your PSK might be something like: "Smith family network key". Click "Apply Changes" to finish. You must now set all wireless clients to match these settings.



IMPORTANT: Make sure your wireless computers are updated to work with WPA2 and have the correct settings to get proper connection to the Router.

Setting WPA Security

Note: To use WPA security, your wireless network cards must be equipped with software that supports WPA. At the time this User Manual was published, a security patch from Microsoft is available for free download. This patch works only with Windows XP.

Your Router supports WPA-PSK (no server). WPA-PSK uses what is known as a pre-shared key as the security key. A pre-shared key is basically a password that is between eight and 39 characters long. It can be a combination of letters, numbers, or characters. Each client uses the same key to access the network. Typically this is the mode that will be used in a home environment.

Setting WPA-PSK

1. From the “Security Mode” drop-down menu, select “WPA-PSK (no server)”.
2. For “Encryption Technique”, select “TKIP” or “AES”. This setting will have to be identical on the clients that you set up.
3. Enter your pre-shared key. This can be from eight to 39 characters and can be letters, numbers, or symbols. This same key must be used on all of the clients that you set up.
4. Click “Apply Changes” to finish. You must now set all clients to match these settings.

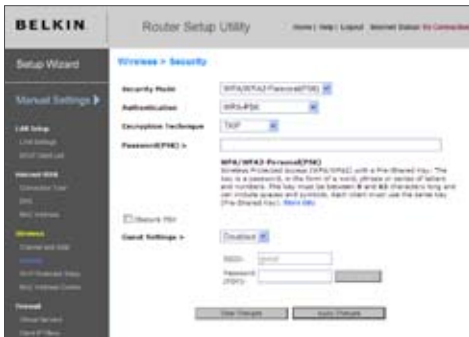

Setting Guest Access

Within the WPA security page, the Guest-Access feature is available. Select this option to create a separate network that allows guests to connect to the Internet while keeping them away from accessing your network, computers, and private files.

1. Select “Enabled” from the drop-down box.
2. Create a guest network name or leave default as “guest”. The name can be 3 to 15 letters or numbers in length.
3. Create a guest password or push the “Generate” button to automatically create this. The password can only be eight letters or numbers in length.



Setting WEP Encryption

Note to Mac users: The “Passphrase” option will not operate with Apple® AirPort®. To configure encryption for your Mac computer, set the encryption using the manual method described in the next section.

1. Select “128-bit WEP” or “64-bit WEP” from the drop-down menu.
2. After selecting your WEP encryption mode, you can enter your WEP key manually by typing in the hex values in the space provided, or you can type a passphrase in the “PassPhrase” field and click “Generate” to create a WEP key from the passphrase. Click “Apply Changes” to finish. You must now set all of your clients to match these settings.



3. Encryption in the Router is now set. Each of your computers on your wireless network will now need to be configured with the same passphrase. Refer to the documentation of your wireless network adapter for information on making this change.

1

2

3

4

5

6

7

8

9

10

section

Using the Web-Based Advanced User Interface

Using a Hexadecimal Key

A hexadecimal key is a mixture of numbers and letters from A–F and 0–9. 64-bit keys are 10 digits long and can be divided into five two-digit numbers. 128-bit keys are 26 digits long and can be divided into 13 two-digit numbers.

For instance:

AF 0F 4B C3 D4 = 64-bit key

C3 03 0F AF 0F 4B B2 C3 D4 4B C3 D4 E7 = 128-bit key

In the boxes below, make up your key by writing in two characters between A–F and 0–9. You will use this key to program the encryption settings on your Router and your wireless computers.

Example:

64-bit:

128-bit:

Note to Mac users: Original Apple AirPort products support 64-bit encryption only. Apple AirPort 2 products can support 64-bit or 128-bit encryption. Please check your product to see which version you are using. If you cannot configure your network with 128-bit encryption, try 64-bit encryption.

Using Wi-Fi Protected Setup

Wi-Fi Protected Setup (WPS) is the industry standard method to simplify the security setup and management of Wi-Fi® networks.

Setting MAC Address Control

The MAC address filter is a powerful security feature that allows you to specify which computers are allowed on the wireless network.

Note: This list applies only to wireless computers. This list can be configured so any computer attempting to access the wireless network that is not specified in the filter list will be denied access. When you enable this feature, you must enter the MAC address of each client (computer) to which you want to allow network access. The “Block” feature lets you turn on and off access to the network easily for any computer without having to add and remove the computer’s MAC address from the list.

The screenshot shows the Belkin Router Setup Utility web interface. The top navigation bar includes the Belkin logo, the title "Router Setup Utility", and links for Home, Help, Logout, and Internet Status (No Connection). The left sidebar contains a "Setup Wizard" section and a "Manual Settings" section with sub-links for LAN Setup, Internet WAN, and Wireless. The main content area is titled "WAN > MAC address" and contains a warning message about cloning MAC addresses. Below the warning, there are two input fields: "WAN MAC Address" with a numeric keypad showing 00, 17, 3F, 87, 72, 13, and "Clone Computer's MAC Address" with a "Clone" button. At the bottom of the main area are "Clear Changes" and "Apply Changes" buttons.

Setting up an Allow Access List

1. Select the “Allow” radio button **(1)** to begin setting up a list of computers allowed to connect to the wireless network.
2. Next, in the “MAC Address” field that is blank **(3)**, type in the MAC address of the wireless computer you want to be able to access the wireless network, then click “<<Add” **(4)**.
3. Continue to do this until all of the computers you want to add have been entered.
4. Click “Apply Changes” **(5)** to finish.

Setting up a Deny Access List

The “Deny Access” list lets you specify computers that you DO NOT want to access the network. Any computer in the list will not be allowed access to the wireless network. All others will.

1. Select the “Deny” radio button **(2)** to begin setting up a list of computers to be denied access to the wireless network.
2. Next, in the “MAC Address” field that is blank **(3)**, type in the MAC address of the wireless computer you want to be able to access the wireless network, then click “<<Add” **(4)**.
3. Continue to do this until all of the computers you want to deny access to have been entered.
4. Click “Apply Changes” **(5)** to finish.

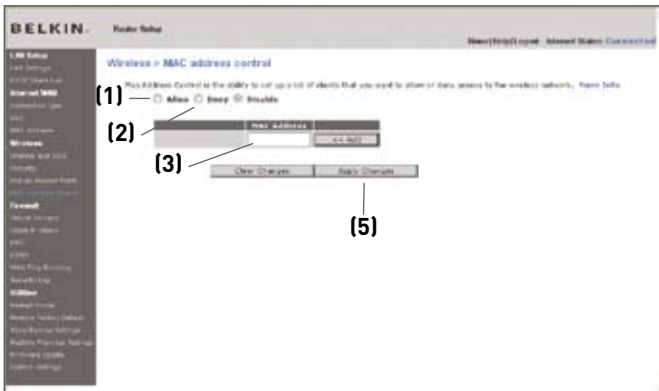

Configuring the Firewall

Your Router is equipped with a firewall that will protect your network from a wide array of common hacker attacks including:

- IP Spoofing
- Land Attack Ping of Death (PoD)
- Denial of Service (DoS)
- IP with zero length
- Smurf Attack
- TCP Null Scan
- SYN flood
- UDP flooding
- Tear Drop Attack
- ICMP defect
- RIP defect
- Fragment flooding

The firewall also masks common ports that are frequently used to attack networks. These ports appear to be “stealth” meaning that for all intents and purposes, they do not exist to a would-be hacker. Disabling the firewall protection will not leave your network completely vulnerable to hacker attacks, but it is recommended that you leave the firewall enabled.



1

2

3

4

5

6

7

8

9

10

section

Configuring Internal Forwarding Settings

The Virtual Servers function will allow you to route external (Internet) calls for services such as a web server (port 80), FTP server (Port 21), or other applications through your Router to your internal network. Since your internal computers are protected by a firewall, computers outside your network (over the Internet) cannot get to them because they cannot be “seen”. A list of common applications has been provided in case you need to configure the Virtual Server function for a specific application. If your application is not listed, you will need to contact the application vendor to find out which port settings you need.

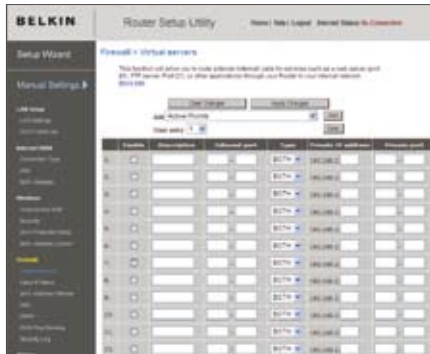

Choosing an Application

Select your application from the drop-down list. Click “Add”. The settings will be transferred to the next available space in the screen. Click “Apply Changes” to save the setting for that application. To remove an application, select the number of the row that you want to remove then click “Clear”.

Manually Entering Settings into the Virtual Server

To manually enter settings, enter the IP address in the space provided for the internal (server) machine, the port(s) required to pass (use a comma between multiple ports), select the port type (TCP or UDP), and click “Apply Changes”. You can only pass one port per internal IP address. Opening ports in your firewall can pose a security risk. You can enable and disable settings very quickly. It is recommended that you disable the settings when you are not using a specific application.

Setting Client IP Filters

The Router can be configured to restrict access to the Internet, e-mail, or other network services at specific days and times. Restriction can be set for a single computer, a range of computers, or multiple computers.



To restrict Internet access to a single computer for example, enter the IP address of the computer you wish to restrict access to in the IP fields **(1)**. Next, enter “80” in both the port fields **(2)**. Select “Both” **(3)**. Select “Block” **(4)**. You can also select “Always” to block access all of the time. Select the day to start on top **(5)**, the time to start on top **(6)**, the day to end on the bottom **(7)**, and the time to stop **(8)** on the bottom. Select “Enable” **(9)**. Click “Apply Changes”. The computer at the IP address you specified will now be blocked from Internet access at the times you specified. Note: Be sure you have selected the correct time zone under “Utilities> System Settings> Time Zone”.

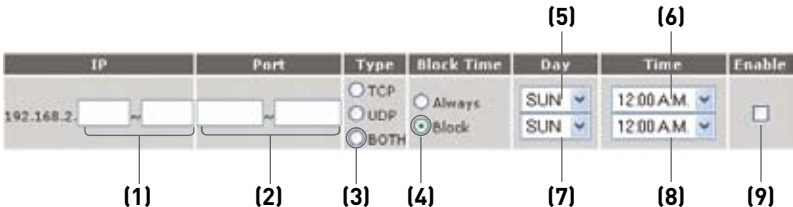

1
2
3
4
5
6
7
8
9
10

section

Enabling the Demilitarized Zone (DMZ)

The DMZ feature allows you to specify one computer on your network to be placed outside of the firewall. This may be necessary if the firewall is causing problems with an application such as a game or video conferencing application. Use this feature on a temporary basis. The computer in the DMZ is **NOT** protected from hacker attacks.



To put a computer in the DMZ, enter the last digits of its IP address in the IP field and select “Enable”. Click “Apply Changes” for the change to take effect. If you are using multiple static WAN IP addresses, it is possible to select which WAN IP address the DMZ host will be directed to. Type in the WAN IP address you wish the DMZ host to direct to, enter the last two digits of the IP address of the DMZ host computer, select “Enable” and click “Apply Changes”.

Using Dynamic DNS

The Dynamic DNS service allows you to alias a dynamic IP address to a static host name in any of the many domains DynDNS.org offers, allowing your network computers to be more easily accessed from various locations on the Internet. DynDNS.org provides this service, for up to five host names, free to the Internet community.

The Dynamic DNSSM service is ideal for a home website, file server, or to make it easy to access your home PC and stored files while you're at work. Using the service can ensure that your host name always points to your IP address, no matter how often your ISP changes it. When your IP address changes, your friends and associates can always locate you by visiting yourname.dyndns.org instead!

To register free for your Dynamic DNS host name, please visit <http://www.dyndns.org>.

1

2

3

4

5

6

7

8

9

10

section

Setting up the Router's Dynamic DNS Update Client

You must register with DynDNS.org's free update service before using this feature. Once you have your registration, follow the directions below.

1. Enter your DynDNS.org user name in the "User Name" field **(1)**.
2. Enter your DynDNS.org password in the "Password" field **(2)**.
3. Enter the DynDNS.org domain name you set up with DynDNS.org in the "Domain Name" field **(3)**.
4. Click "Update DDNS/Apply" to update your IP address.

Whenever your IP address assigned by your ISP changes, the Router will automatically update DynDNS.org's servers with your new IP address. You can also do this manually by clicking the "Update DDNS/Apply" button **(4)**.

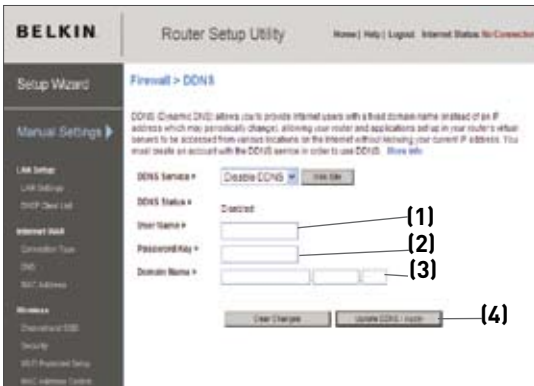

Blocking an ICMP Ping

Computer hackers use what is known as “pinging” to find potential victims on the Internet. By pinging a specific IP address and receiving a response from the IP address, a hacker can determine that something of interest might be there. The Router can be set up so it will not respond to an ICMP ping from the outside. This heightens your Router’s security level.



To turn off the ping response, select “Block ICMP Ping” **(1)** and click “Apply Changes”. The Router will not respond to an ICMP ping.

1

2

3

4

5

6

7

8

9

10

section

Using the Web-Based Advanced User Interface

Utilities

The “Utilities” screen lets you manage different parameters of the Router and perform certain administrative functions.



Restarting the Router

Sometimes it may be necessary to restart or reboot the Router if it begins working improperly. Restarting or rebooting the Router will **NOT** delete any of your configuration settings.

Restarting the Router to Restore Normal Operation

1. Click the “Restart Router” button.



2. The following message will appear. Click “OK”.



3. The following message will appear. Restarting the Router can take up to 80 seconds. It is important not to turn off the power to the Router during the restart.



4. An 80-second countdown will appear on the screen. When the countdown reaches zero, the Router will be restarted. The Router home page should appear automatically. If not, type in the Router’s address (default = 192.168.2.1) into the navigation bar of your browser.

Restoring Factory Default Settings

Using this option will restore all of the settings in the Router to the factory (default) settings. It is recommended that you back up your settings before you restore all of the defaults.

1. Click the “Restore Defaults” button.



2. The following message will appear. Click “OK”.



3. An 80-second countdown will appear on the screen. When the countdown reaches zero, the Router’s defaults will be restored. The Router’s home page should appear automatically. If it does not, type in the Router’s address (default = 192.168.2.1) into the navigation bar of your browser.

1

2

3

4

5

6

7

8

9

10

Saving a Current Configuration

You can save your current configuration by using this feature. Saving your configuration will allow you to restore it later if your settings are lost or changed. It is recommended that you back up your current configuration before performing a firmware update.



1. Click “Save”. A window called “File Download” will open. Click “Save”.



2. A window will open that allows you to select the location where you want to save the configuration file. Select a location. You can name the file anything you want, or use the default name “Config”. Be sure to name the file so you can locate it yourself later. When you have selected the location and name of the file, click “Save”.

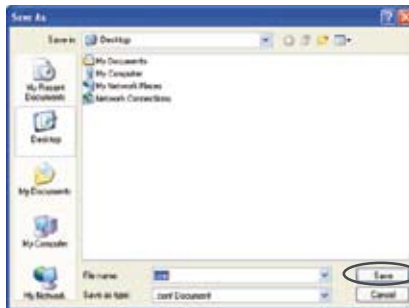

- When the save is complete, you will see this window. Click “Close”.
The configuration is now saved.



Restoring a Previous Configuration

This option will allow you to restore a previously saved configuration.



- Click “Browse”. A window will open that allows you to select the location of the configuration file. All configuration files end with a “.cfg”. Locate the configuration file you want to restore and double-click on it.

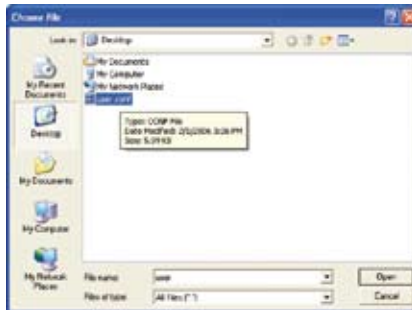

1

2

3

4

5

6

7

8

9

10

Using the Web-Based Advanced User Interface

2. You will be asked if you want to continue. Click "OK".



3. A reminder window will appear. It will take up to 60 seconds for the configuration restoration to complete. Click "OK".



4. A 60-second countdown will appear on the screen. When the countdown reaches zero, the Router's configuration will be restored. The Router home page should appear automatically. If not, type in the Router's address (default = 192.168.2.1) into the navigation bar of your browser.

Updating the Firmware

From time to time, Belkin may release new versions of the Router's firmware. Firmware updates contain feature improvements and fixes to problems that may have existed. When Belkin releases new firmware, you can download the firmware from the Belkin update website and update your Router's firmware to the latest version.



Checking for a New Version of Firmware

The "Check Firmware" (1) button allows you to instantly check for a new version of firmware. When you click the button, a new browser window will appear informing you that either no new firmware is available or that there is a new version available. If a new version is available, you will have the option to download it.

1

2

3

4

5

6

7

8

9

10

section

Downloading a New Version of Firmware

If you click the “Check Firmware” button and a new version of firmware is available, you will see a screen similar to the one below:

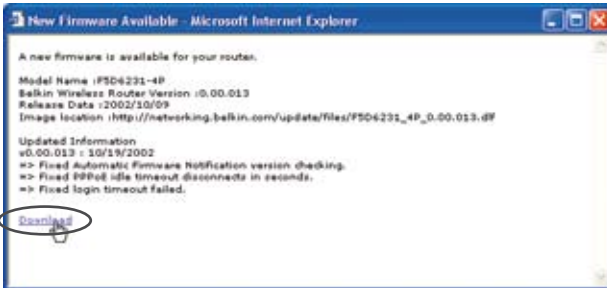

1. To download the new version of firmware, click “Download”.
2. A window will open that allows you to select the location where you want to save the firmware file. Select a location. You can name the file anything you want, or use the default name. Be sure to locate the file in a place where you can locate it yourself later. When you have selected the location, click “Save”.



3. When the save is complete, you will see the following window. Click "Close".

The download of the firmware is complete. To update the firmware, follow the next steps in "Updating the Router's Firmware".

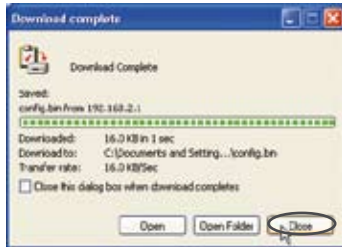

Updating the Router's Firmware

1. In the "Firmware Update" page, click "Browse". A window will open that allows you to select the location of the

firmware update file.

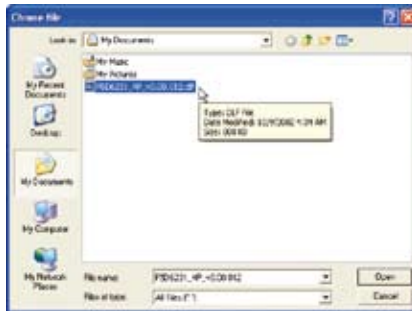

1

2

3

4

5

6

7

8

9

10

Using the Web-Based Advanced User Interface

3. The “Update Firmware” box will now display the location and name of the firmware file you just selected. Click “Update”.



4. You will be asked if you are sure you want to continue. Click “OK”.



5. You will see one more message. This message tells you that the Router may not respond for as long as one minute as the firmware is loaded into the Router and the Router is rebooted. Click “OK”.



6. An 80-second countdown will appear on the screen. When the countdown reaches zero, the Router firmware update will be complete. The Router’s home page should appear automatically. If not, type in the Router’s address (default = 192.168.2.1) into the navigation bar of your browser.

Changing System Settings

The “System Settings” page is where you can enter a new administrator password, set the time zone, enable remote management, and turn on and off the NAT function of the Router.

Setting or Changing the Administrator Password

The Router ships with NO password entered. If you wish to add a password for greater security, you can set a password here. Write down your password and keep it in a safe place, as you will need it if you need to log into the Router in the future. It is also recommended that you set a password if you plan to use the remote management feature of your Router.

Administrator Password:
The Router ships with NO password entered. If you wish to add a password for more security, you can set a password here. [More Info](#)

- Type in current Password >

- Type in new Password >

- Confirm new Password >

- Login Timeout > (1-99 minutes)

Changing the Login Time-Out Setting

The login time-out option allows you to set the period of time that you can be logged into the Router’s advanced setup interface. The timer starts when there has been no activity. For example, imagine you have made some changes in the advanced setup interface, then left your computer alone without clicking “Logout”. Assuming the time-out is set to 10 minutes, 10 minutes after you leave, the login session will expire. You will have to log into the Router again to make any more changes. The login time-out option is for security purposes and the default is set to 10 minutes.

Note: Only one computer can be logged into the Router’s advanced setup interface at one time.

Setting the Time and Time Zone

The Router keeps time by connecting to a Simple Network Time Protocol (SNTP) server. This allows the Router to synchronize the system clock to the global Internet. The synchronized clock in the Router is used to record the security log and control client filtering. Select the time zone that you reside in. You have the option to select a primary and a backup NTP server to keep your Router's clock synchronized. Select your desired NTP server from the drop-down box, or simply keep it as is.

If you reside in an area that observes daylight saving, then place a check mark in the box next to "Enable Daylight Saving". The system clock may not update immediately. Allow at least 15 minutes for the Router to contact the time servers on the Internet and get a response. You cannot set the clock yourself.



The screenshot shows a web interface for setting the time and time zone. At the top, it displays the current date and time: "May 11, 2007 07:03:01 AM". Below this, there is a heading "Time and Time Zone:" and a sub-heading "Please set your Time Zone. If you are in an area that observes daylight saving check this box. More Info". There are two main settings: "Time Zone" and "Daylight Savings". The "Time Zone" is set to "(GMT-08:00) Pacific Time (US & Canada) Tucson" with a dropdown arrow. The "Daylight Savings" option is checked, with the label "Automatically Adjust Daylight Saving".

Enabling Remote Management

Before you enable this advanced feature of your Belkin Router, **MAKE SURE YOU HAVE SET THE ADMINISTRATOR PASSWORD**. Remote management allows you to make changes to your Router's settings from anywhere on the Internet. There are two methods of remotely managing the Router. The first is to allow access to the Router from anywhere on the Internet by selecting "Any IP address can remotely manage the Router". By typing in your WAN IP address from any computer on the Internet, you will be presented with a login screen where you need to type in the password of your Router. The second method is to allow a specific IP address only to remotely manage the Router. This is more secure, but less convenient. To use this method, enter the IP address you know you will be accessing the Router from in the space provided and select "Only this IP address can remotely manage the Router". Before you enable this function, it is **STRONGLY RECOMMENDED** that you set your administrator password. Leaving the password empty will potentially open your Router to intrusion.

Using the Web-Based Advanced User Interface

Advanced Feature: The “Remote Access Port” option allows you to configure the desired “Remote Access Port for Remote Management” feature. The default access port is set to port 80.

Remote Management:

ADVANCED FEATURE! Remote management allows you to make changes to your Router's settings from anywhere on the Internet. Before you enable this function, **MAKE SURE YOU HAVE SET THE ADMINISTRATOR PASSWORD.** [More Info](#)

Any IP address can remotely manage the router.

Only this IP address can remotely manage the router > ...

1

2

3

4

5

6

7

8

9

10

section

Enabling/Disabling UPnP

UPnP (Universal Plug-and-Play) is yet another advanced feature offered by your Belkin Router. It is a technology that offers seamless operation of voice messaging, video messaging, games, and other applications that are UPnP-compliant. Some applications require the Router's firewall to be configured in a specific way to operate properly. This usually requires opening TCP and UDP ports, and in some instances, setting trigger ports. An application that is UPnP-compliant has the ability to communicate with the Router, basically "telling" the Router which way it needs the firewall configured. The Router ships with the UPnP feature disabled. If you are using any applications that are UPnP-compliant, and wish to take advantage of the UPnP features, you can enable the UPnP feature. Simply select "Enable" in the "UPnP Enabling" section of the "Utilities" page. Click "Apply Changes" to save the change.



Enabling/Disabling Auto Firmware Update

This innovation provides the Router with the built-in capability to automatically check for a new version of firmware and alert you that the new firmware is available. When you log into the Router's advanced interface, the Router will perform a check to see if new firmware is available. If so, you will be notified. You can choose to download the new version or ignore it.

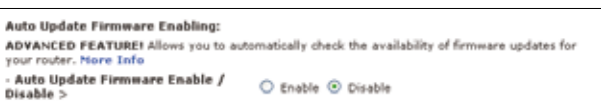

Manually Configuring Network Settings

Set up the computer that is connected to the ADSL modem FIRST using these steps. You can also use these steps to add computers to your Router after the Router has been set up to connect to the Internet.

Manually Configuring Network Settings in Mac OS up to 9.x

1. Pull down the Apple menu. Select “Control Panels” and select “TCP/IP”.
2. You will see the TCP/IP control panel. Select “Ethernet Built-In” or “Ethernet” in the “Connect via:” drop-down menu (1).

3. Next to “Configure” (2), if “Manually” is selected, your Router will need to be set up for a static IP connection type. Write the address information in the table below. You will need to enter this information into the Router.

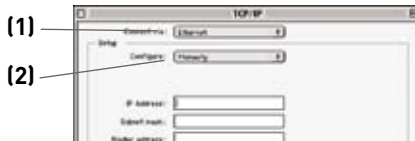

IP address:	<input type="text"/>
Subnet Mask:	<input type="text"/>
Router Address:	<input type="text"/>
Name Server Address:	<input type="text"/>

4. If not already set, at “Configure:”, choose “Using DHCP Server”. This will tell the computer to obtain an IP address from the Router.



5. Close the window. If you made any changes, the following window will appear. Click “Save”.



Restart the computer. When the computer restarts, your network settings are now configured for use with the Router.

1

2

3

4

5

6

7

8

9

10

section

Manually Configuring Network Settings

Manually Configuring Network Settings in Mac OS X

1. Click on the “System Preferences” icon.



2. Select “Network” (1) from the “System Preferences” menu.
3. Select “Built-in Ethernet” (2) next to “Show” in the Network menu.



(1)

(5)

(2)

(3)

(4)



Manually Configuring Network Settings

4. Select the “TCP/IP” tab **(3)**. Next to “Configure” **(4)**, you should see “Manually” or “Using DHCP”. If you do not, check the PPPoE tab **(5)** to make sure that “Connect using PPPoE” is NOT selected. If it is, you will need to configure your Router for a PPPoE connection type using your user name and password.
5. If “Manually” is selected, your Router will need to be set up for a static IP connection type. Write the address information in the table below. You will need to enter this information into the Router.

IP address:	<input type="text"/>
Subnet Mask:	<input type="text"/>
Router Address:	<input type="text"/>
Name Server Address:	<input type="text"/>

6. If not already selected, select “Using DHCP” next to “Configure” **(4)**, then click “Apply Now”.

Your network settings are now configured for use with the Router.

1

2

3

4

5

6

7

8

9

10

section

Manually Configuring Network Settings

Manually Configuring Network Settings in Windows 2000, NT®, or XP

1. Click “Start”, “Settings”, then “Control Panel”.
2. Double-click on the “Network and dial-up connections” icon (Windows 2000) or the “Network” icon (Windows XP).
3. Right-click on the “Local Area Connection” associated with your network adapter and select “Properties” from the drop-down menu.
4. In the “Local Area Connection Properties” window, click “Internet Protocol (TCP/IP)” and click the “Properties” button. The following screen will appear:

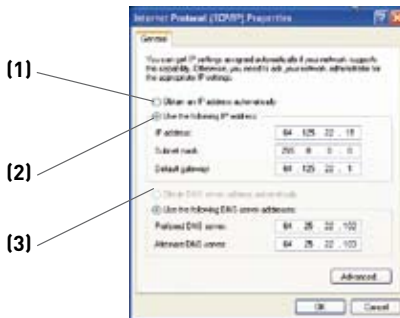

5. If “Use the following IP address” **(2)** is selected, your Router will need to be set up for a static IP connection type. Write the address information in the table below. You will need to enter this information into the Router.

IP address:	<input type="text"/>
Subnet Mask:	<input type="text"/>
Default gateway:	<input type="text"/>
Preferred DNS server:	<input type="text"/>
Alternate DNS server:	<input type="text"/>

6. If not already selected, select “Obtain an IP address automatically” **(1)** and “Obtain DNS server address automatically” **(3)**. Click “OK”.

Your network settings are now configured for use with the Router.

Manually Configuring Network Settings

Manually Configuring Network Adapters in Windows 98SE or Me

1. Right-click on “My Network Neighborhood” and select “Properties” from the drop-down menu.
2. Select “TCP/IP Settings” for your installed network adapter. You will see the following window.

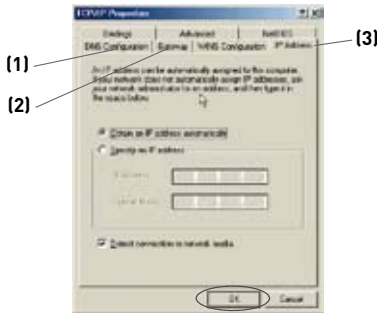

3. If “Specify an IP address” is selected, your Router will need to be set up for a static IP connection type. Write the address information in the table below. You will need to enter this information into the Router.
4. Write the IP address and subnet mask from the “IP Address” tab **(3)**.
5. Click the “Gateway” tab **(2)**. Write the gateway address down in the chart.
6. Click the “DNS Configuration” tab **(1)**. Write the DNS address(es) in the chart.
7. If not already selected, select “Obtain IP address automatically” on the IP address tab. Click “OK”.

IP address:	<input type="text"/>
Subnet Mask:	<input type="text"/>
Default gateway:	<input type="text"/>
Preferred DNS server:	<input type="text"/>
Alternate DNS server:	<input type="text"/>

Restart the computer. When the computer restarts, your network adapter(s) are now configured for use with the Router.

1

2

3

4

5

6

7

8

9

10

section

Recommended Web Browser Settings

In most cases, you will not need to make any changes to your web browser's settings. If you are having trouble accessing the Internet or the advanced web-based user interface, then change your browser's settings to the recommended settings in this section.

Microsoft® Internet Explorer 4.0 or Higher

1. Start your web browser. Select “Tools” then “Internet Options”.

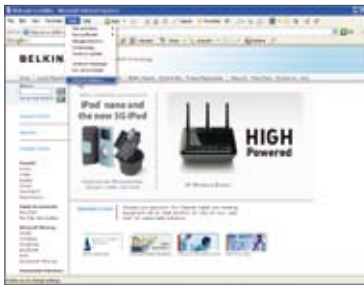

2. In the “Internet Options” screen, there are three selections: “Never dial a connection”, “Dial whenever a network connection is not present”, and “Always dial my default connection”. If you can make a selection, select “Never dial a connection”. If you cannot make a selection, go to the next step.



3. Under the “Internet Options” screen, click on “Connections” and select “LAN Settings...”.

Recommended Web Browser Settings

4. Make sure there are no check marks next to any of the displayed options: “Automatically detect settings”, “Use automatic configuration script”, and “Use a proxy server”. Click “OK”. Then click “OK” again in the “Internet Options” page.

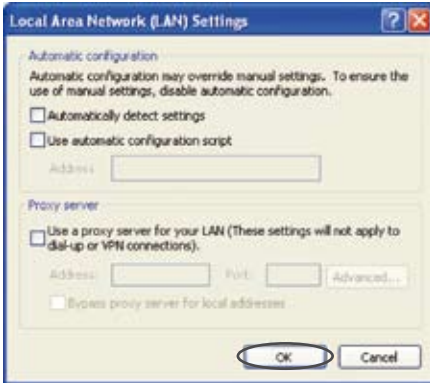

Netscape® Navigator® 4.0 or Higher

1. Start Netscape. Click on “Edit” then “Preferences”.
2. In the “Preferences” window, click on “Advanced” then select “Proxies”. In the “Proxies” window, select “Direct connection to the Internet”.

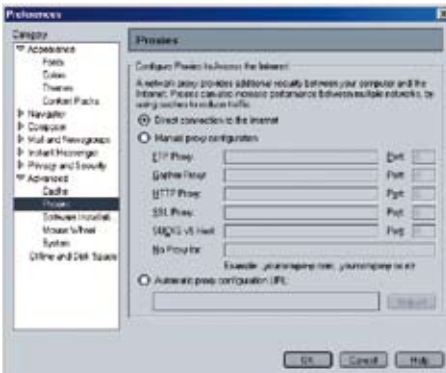

1
2
3
4
5
6
7
8
9
10

section

Troubleshooting

Assistant CD does not automatically start.

If the CD-ROM does not start the Assistant software automatically, it could be that the computer is running other applications that are interfering with the CD drive.

1. If the Assistant software's Welcome screen does not appear within 15-20 seconds, open up your CD-ROM drive by double-clicking on the "My Computer" icon that is located on your desktop.
2. Next, double-click on the CD-ROM drive that the Assistant software CD has been placed in to start the installation.
3. The Assistant software should start within a few seconds. If, instead, a window appears showing the files on the CD, double-click on the icon labeled "setup.exe".
4. If the Assistant software still does not start, reference the section titled "Manually Configuring Network Settings" (page 87) in this User Manual for an alternative setup method).

Assistant software cannot find my Router.

If the Assistant software is not able to find the Router during the installation process, please check the following items:

1. If the Assistant software is not able to find the Router during the installation process, there may be third-party firewall software installed on the computer attempting to access the Internet. Examples of third-party firewall software are ZoneAlarm, BlackICE PC Protection, McAfee Personal Firewall, and Norton Personal Firewall. If you do have firewall software installed on your computer, please make sure that you properly configure it. You can determine if the firewall software is preventing Internet access by temporarily turning it off. If, while the firewall is disabled, Internet access works properly, you will need to change the firewall settings to function properly when it is turned on. Please refer to the instructions provided by the publisher of your firewall software for instructions on configuring the firewall to allow Internet access.

Troubleshooting

2. Unplug power to the Router for 10 seconds, and then plug the power back into the Router. Ensure that the Router's "router" Display is on. If not, check to make sure that the AC adapter is connected to the Router and plugged into a wall outlet.
3. Ensure that you have a cable connected between the network (Ethernet) port on the back of the computer and one of the "to Wired Computers" ports on the back of the Router.
Note: The computer should NOT be connected to the port labeled "to ADSL" on the back of the Router.
4. Try shutting down and restarting your computer, then rerunning the Assistant software.

If the Assistant software is still unable to find the Router, reference the section titled "Manually Configuring Network Settings" for installation steps.

Assistant software cannot connect my Router to the Internet.

If the Assistant software is not able to connect the Router to the Internet, please check the following items:

1. Use the troubleshooting suggestions within the Assistant software.
2. If your ISP requires a user name and password, make sure that you have typed in your user name and password correctly. Some user names require that the ISP's domain may be at the end of the name. Example: "myname@myisp.com". The "@myisp.com" part of the user name may need to be typed as well as your user name.

If you continue to have no Internet connection, reference the section titled "Manually Configuring Network Settings" (page 87 of this User Manual for an alternative setup method).

1

2

3

4

5

6

7

8

9

10

section

- **The Assistant software completed installation, but my web browser doesn't work.**
- **I am unable to connect to the Internet. The "ADSL" icon on my Router is blinking, and the "internet" icon is blinking.**

If you cannot connect to the Internet, and the "ADSL" icon is blinking, and the "internet" icon is blinking, the problem may be that your ADSL cable and Router are not connected properly.

1. Make sure the network cable between the telephone outlet and the Router is connected. The cable should be connected at one end to the Router's "to ADSL" port, and at the other end to the telephone outlet.
2. Unplug the power to your Router, wait 10 seconds, and then reconnect the power. This will cause the Router to reattempt communication with the ADSL line. If the "ADSL" icon on the Router is not lit after completing these steps, please contact Belkin Technical Support.
3. Try shutting down and restarting your computer.

- **The Assistant software completed installation, but my web browser doesn't work.**
- **I am unable to connect to the Internet. The "ADSL" icon on my Router is on, and the "internet" icon is blinking.**
 1. If you cannot connect to the Internet, the "ADSL" icon is on, and the "internet" icon is blinking, the problem may be that your connection type may not match the ISP's connection.
 2. If you have a "static IP address" connection, your ISP must assign you the IP address, subnet mask, and gateway address. Please refer to the section entitled "Alternate Setup Method" for details on changing this setting.
 3. If you have a "PPPoE" connection, your ISP will assign you a user name and password and sometimes a service name. Make sure the Router's connection type is configured to PPPoE and the settings are entered properly. Please refer to the section entitled "Alternate Setup Method" for details on changing this setting.
 4. You may need to configure your Router to meet the specific requirements of your ISP. To search our knowledge base for ISP-specific issues, go to: <http://web.belkin.com/support> and type "ISP" into the "Product Support Search" text box.

If you are still unable to access the Internet after verifying these settings, please contact Belkin Technical Support.

1

2

3

4

5

6

7

8

9

10

section

- **The Assistant software completed, but my web browser doesn't work.**
- **I am unable to connect to the Internet. The "ADSL" icon on my Router is blinking, and the "internet" icon is solid.**
 1. If the "ADSL" icon is blinking, and the "internet" icon is solid, but you are unable to access the Internet, there may be third-party firewall software installed on the computer attempting to access the Internet. Examples of third-party firewall software are ZoneAlarm, BlackICE PC Protection, McAfee Personal Firewall, and Norton Personal Firewall.
 2. If you do have firewall software installed on your computer, please make sure that you properly configure it. You can determine if the firewall software is preventing Internet access by temporarily turning it off. If, while the firewall is disabled, Internet access works properly, you will need to change the firewall settings to function properly when it is turned on.
 3. Please refer to the instructions provided by the publisher of your firewall software for instructions on configuring the firewall to allow Internet access.

If you are still unable to access the Internet after disabling any firewall software, please contact Belkin Technical Support.

I can't connect to the Internet wirelessly.

If you are unable to connect to the Internet from a wireless computer, please check the following items:

1. Look at the lights on your Router. They should be as follows:
 - The “router” icon should be on.
 - The “radio wave” icon above the “router” icon should be on.
 - The “ADSL” light should be on, and not blinking.
 - The “internet” icon should be on, and not blinking.
 - The “Wireless” light should be on, not blinking.
2. Open your wireless utility software by clicking on the icon in the system tray at the bottom, right-hand corner of the screen.
3. The exact window that opens will vary depending on the model of wireless card you have; however, any of the utilities should have a list of “Available Networks”—those wireless networks it can connect to.

Does the name of your wireless network appear in the results?

Yes, my network name is listed—go to the troubleshooting solution titled “I can't connect to the Internet wirelessly, but my network name is listed”.

No, my network name is not listed—go to the troubleshooting solution titled “I can't connect to the Internet wirelessly, and my network name is not listed”.

I can't connect to the Internet wirelessly, but my network name is listed.

If the name of your network is listed in the "Available Networks" list, please follow the steps below to connect wirelessly:

1. Click on the correct network name in the "Available Networks" list.
2. If the network has security (encryption) enabled, you will need to enter the network key. For more information regarding security, see the section entitled "Changing the Wireless Security Settings".
3. Within a few seconds, the tray icon in the lower, left-hand corner of your screen should turn green, indication of a successful connection to the network.

I can't connect to the Internet wirelessly, and my network name is not listed.

If the correct network name is not listed under "Available Networks" in the wireless utility, please attempt the following troubleshooting steps:

1. Temporarily move computer, if possible, five to 10 feet from the Router. Close the wireless utility, and reopen it. If the correct network name now appears under "Available Networks", you may have a range or interference problem. Please see the suggestions discussed in the section titled "Placement of your Router" in this User Manual.
2. Using a computer that is connected to the Router via a network cable (as opposed to wirelessly), ensure that "Broadcast SSID" is enabled. This setting is found on the Router's wireless "Channel and SSID" configuration page.

If you are still unable to access the Internet after completing these steps, please contact Belkin Technical Support.

- **My wireless network performance is inconsistent.**
- **Data transfer is sometimes slow.**
- **Signal strength is poor.**
- **Difficulty establishing and/or maintaining a Virtual Private Network (VPN) connection.**

Wireless technology is radio-based, which means connectivity and the throughput performance between devices decreases when the distance between devices increases. Other factors that will cause signal degradation (metal is generally the worst culprit) are obstructions such as walls and metal appliances. Note also that connection speed may decrease as you move farther away from the Router.

In order to determine if wireless issues are related to range, we suggest temporarily moving the computer, if possible, five to 10 feet from the Router.

Changing the wireless channel—Depending on local wireless traffic and interference, switching the wireless channel of your network can improve performance and reliability. The default channel the Router is shipped with is channel 11; you may choose from several other channels depending on your region. See the section on page 52 entitled “Changing the Wireless Channel” for instructions on how to choose other channels.

Limiting the wireless transmit rate—Limiting the wireless transmit rate can help improve the maximum wireless range and connection stability. Most wireless cards have the ability to limit the transmission rate. To change this property, go to the Windows Control Panel, open “Network Connections” and double-click on your wireless card’s connection. In the properties dialog, select the “Configure” button on the “General” tab (Windows 98 users will have to select the wireless card in the list box and then click “Properties”), then choose the “Advanced” tab and select the rate property.

Wireless client cards are usually set to automatically adjust the wireless transmit rate for you, but doing so can cause periodic disconnects when the wireless signal is too weak; as a rule, slower transmission rates are more stable. Experiment with different connection rates until you find the best one for your environment. Note that all available transmission rates should be acceptable for browsing the Internet. For more assistance, see your wireless card’s user manual.

1

2

3

4

5

6

7

8

9

10

I am having difficulty setting up Wired Equivalent Privacy (WEP) security on my Belkin Router.

1. Log into your Router.

Open your web browser and type in the IP address of the Router. (The Router's default is 192.168.2.1.) Log into your Router by clicking on the "Login" button in the top right-hand corner of the screen. You will be asked to enter your password. If you never set a password, leave the "Password" field blank and click "Submit".

Click the "Wireless" tab on the left of your screen. Select the "Encryption" or "Security" tab to get to the security settings page.

2. Select "128-bit WEP" from the drop-down menu.
3. After selecting your WEP encryption mode, you can type in your hex WEP key manually, or you can type in a passphrase in the "Passphrase" field and click "Generate" to create a WEP key from the passphrase. Click "Apply Changes" to finish. You must now set all of your clients to match these settings. A hex (hexadecimal) key is a mixture of numbers and letters from A-F and 0-9. For 128-bit WEP, you need to enter 26 hex keys.

For example:

C3030FAF4BB2C3D44BC3D4E7E4 = 128-bit key

4. Click "Apply Changes" to finish. Encryption in the Router is now set. Each of your computers on your wireless network will now need to be configured with the same security settings.

WARNING: If you are configuring the Router from a computer with a wireless client, you will need to ensure that security is turned on for this wireless client. If this is not done, you will lose your wireless connection.

Note to Mac users: Original Apple AirPort products support 64-bit encryption only. Apple AirPort 2 products can support 64-bit or 128-bit encryption. Please check your Apple AirPort product to see which version you are using. If you cannot configure your network with 128-bit encryption, try 64-bit encryption.

I am having difficulty setting up Wired Equivalent Privacy (WEP) security on a Belkin client card.

The client card must use the same key as the Router. For instance, if your Router uses the key 00112233445566778899AABBCC, then the client card must be set to the exact same key.

1. Double-click the Signal Indicator icon to bring up the “Wireless Network” screen.
2. The “Advanced” button will allow you to view and configure more options of the card.
3. Once the “Advanced” button is clicked, the Belkin Wireless LAN Utility will appear. This Utility will allow you to manage all the advanced features of the Belkin Wireless Card.
4. Under the “Wireless Network Properties” tab, select a network name from the “Available Networks” list and click the “Properties” button.
5. Under “Data Encryption”, select “WEP”.
6. Ensure the check box “The key is provided for me automatically” at the bottom is unchecked. If you are using this computer to connect to a corporate network, please consult your network administrator if this box needs to be checked.
7. Type your WEP key in the “Network key” box.

Important: A WEP key is a mixture of numbers and letters from A-F and 0-9. For 128-bit WEP, you need to enter 26 keys. This network key needs to match the key you assign to your Router.

For example:

C3030FAF4BB2C3D44BC3D4E7E4 = 128-bit key

8. Click “OK”, and then “Apply” to save the settings.

If you are NOT using a Belkin wireless client card, please consult the manufacturer’s user manual for that wireless client card.

1

2

3

4

5

6

7

8

9

10

section

Do Belkin products support WPA?

Note: To use WPA security, all your clients must be upgraded to drivers and software that support it. At the time of this FAQ publication, a security patch download is available, for free, from Microsoft. This patch works only with the Windows XP operating system.

Download the patch here:

<http://www.microsoft.com/downloads/details>.

You also need to download the latest driver for your Belkin Wireless Network Card from the Belkin support site. Other operating systems are not supported at this time. Microsoft's patch only supports devices with WPA-enabled drivers such as Belkin N1 products

Download the latest driver at <http://web.belkin.com/support> for the following products:

F5D8001, F5D8011, F5D5051, F5D8071

I am having difficulty setting up Wireless Protected Access (WPA) security on my Belkin Router for a home network.

1. From the "Security Mode" drop-down menu, select "WPA-PSK (no server)".
2. For "Encryption Technique", select "TKIP". This setting will have to be identical on the clients that you set up.
3. Enter your pre-shared key. This can be from eight to 63 characters and can be letters, numbers, symbols, or spaces. This same key must be used on all of the clients that you set up. For example, your PSK might be something like: "Smith family network key".
4. Click "Apply Changes" to finish. You must now set all clients to match these settings.

I am having difficulty setting up Wireless Protected Access (WPA) security on a Belkin wireless client card for a home network.

Clients must use the same key that the Router uses. For instance, if the key is “Smith Family Network Key” in the Router, the clients must also use that same key.

1. Double-click the Signal Indicator icon to bring up the “Wireless Network” screen. The “Advanced” button will allow you to view and configure more options of your card.
2. Once the “Advanced” button is clicked, the Belkin Wireless Utility will appear. This Utility will allow you to manage all the advanced features of the Belkin Wireless Card.
3. Under the “Wireless Network Properties” tab, select a network name from the “Available Networks” list and click the “Properties” button.
4. Under “Network Authentication”, select “WPA-PSK (no server)”.
5. Type your WPA key in the “Network key” box.

Important: WPA-PSK is a mixture of numbers and letters from A-Z and 0-9. For WPA-PSK you can enter eight to 63 characters. This network key needs to match the key you assign to your Router.

6. Click “OK, then “Apply” to save the settings.

1

2

3

4

5

6

7

8

9

10

I am NOT using a Belkin client card for a home network and I am having difficulty setting up Wireless Protected Access (WPA) security.

If you are not using a Belkin Wireless Desktop or Wireless Notebook Network Card that is not equipped with WPA-enabled software, a file from Microsoft called “Windows XP Support Patch for Wireless Protected Access” is available for free download. Download the patch from Microsoft by searching the knowledge base for Windows XP WPA.

Note: The file that Microsoft has made available works only with Windows XP. Other operating systems are not supported at this time. You also need to ensure that the wireless card’s manufacturer supports WPA and that you have downloaded and installed the latest driver from their support site.

Supported Operating Systems:

- Windows XP Professional
 - Windows XP Home Edition
1. Under Windows XP, click “Start > Control Panel > Network Connections”.
 2. Right-clicking on the “Wireless Networks” tab will display the following screen. Ensure the “Use Windows to configure my wireless network settings” check box is checked.



- Under the “Wireless Networks” tab, click the “Configure” button and you will see the following screen.



- For a home or small business user, select “WPA-PSK” under “Network Administration”.

Note: Select WPA (with radius server) if you are using this computer to connect to a corporate network that supports an authentication server such as a radius server. Please consult your network administrator for further information.

- Select “TKIP” or “AES” under “Data Encryption”. This setting will have to be identical to the Router that you set up.
- Type in your encryption key in the “Network key” box.

Important: Enter your pre-shared key. This can be from eight to 63 characters and can be letters, numbers, or symbols. This same key must be used on all of the clients that you set up.

- Click “OK” to apply settings.

What’s the difference between 802.11b, 802.11g, 802.11a, and draft 802.11n?

Currently there are four levels of wireless networking standards, which transmit data at very different maximum speeds. Each is based on the designation for certifying network standards. The most common wireless networking standard, 802.11b, transmits information at 11Mbps; 802.11a and 802.11g work at 54Mbps; and draft 802.11n works at 108Mbps. See the chart on the next page for more detailed information.

Wireless Comparison Chart

Wireless Technology	802.11b	G (802.11g)	G Plus (802.11g with HSM)	G Plus MIMO (802.11g with MIMO MRC)	N1 MIMO (draft 802.11n with MIMO)
Speed*	11Mbps link rate/baseline	5x faster than 802.11b*	10x faster than 802.11b*	10x faster than 802.11b*	Wired speed over the air*
Frequency	Common household devices such as cordless phones and microwave ovens may interfere with the unlicensed band 2.4GHz	Common household devices such as cordless phones and microwave ovens may interfere with the unlicensed band 2.4GHz	Common household devices such as cordless phones and microwave ovens may interfere with the unlicensed band 2.4GHz	Common household devices such as cordless phones and microwave ovens may interfere with the unlicensed band 2.4GHz	Common household devices such as cordless phones and microwave ovens may interfere with the unlicensed band 2.4GHz
Compatibility	Compatible with 802.11g	Compatible with 802.11b/g	Compatible with 802.11b/g	Compatible with 802.11b/g	Compatible with draft 802.11n** and 802.11b/g
Coverage*	Typically 100–200 ft. indoors	Up to 400 ft.*	Up to 700 ft.*	Up to 1,000 ft.*	Up to 1,400 ft.*
Advantage	Mature—legacy technology	Common—widespread use for Internet sharing	Enhanced speed and coverage	Better coverage and consistent speed at range	Leading edge—best coverage and throughput

*Distance and connection speeds will vary depending on your networking environment.

**This Router is compatible with products based on the same version of the draft 802.11n specifications, and may require a software upgrade for best results.

Free Tech Support*

You can find additional support information on our website www.belkin.com through the tech-support area. If you want to contact technical support by phone, please call the number you need from the list below*.

*Local rates apply

Country	Number	Internet address
AUSTRIA	0820 200766	http://www.belkin.com/uk/networking/
BELGIUM	07 07 00 073	http://www.belkin.com/nl/networking/
CZECH REPUBLIC	239 000 406	http://www.belkin.com/uk/networking/
DENMARK	701 22 403	http://www.belkin.com/uk/networking/
FINLAND	00800 - 22 35 54 60	http://www.belkin.com/uk/networking/
FRANCE	08 - 25 54 00 26	http://www.belkin.com/fr/networking/
GERMANY	0180 - 500 57 09	http://www.belkin.com/de/networking/
GREECE	00800 - 44 14 23 90	http://www.belkin.com/uk/networking/
HUNGARY	06 - 17 77 49 06	http://www.belkin.com/uk/networking/
ICELAND	800 8534	http://www.belkin.com/uk/networking/
IRELAND	0818 55 50 06	http://www.belkin.com/uk/networking/
ITALY	02 - 69 43 02 51	http://www.belkin.com/it/support/tech/issues_more.asp
LUXEMBOURG	34 20 80 85 60	http://www.belkin.com/uk/networking/
NETHERLANDS	0900 - 040 07 90 €0.10 per minute	http://www.belkin.com/nl/networking/
NORWAY	81 50 0287	http://www.belkin.com/uk/networking/
POLAND	00800 - 441 17 37	http://www.belkin.com/uk/networking/
PORTUGAL	707 200 676	http://www.belkin.com/uk/networking/
RUSSIA	495 580 9541	http://www.belkin.com/networking/
SOUTH AFRICA	0800 - 99 15 21	http://www.belkin.com/uk/networking/
SPAIN	902 - 02 43 66	http://www.belkin.com/es/support/tech/networkingsupport.asp
SWEDEN	07 - 71 40 04 53	http://www.belkin.com/se/support/tech/networkingsupport.asp
SWITZERLAND	08 - 48 00 02 19	http://www.belkin.com/uk/networking/
UNITED KINGDOM	0845 - 607 77 87	http://www.belkin.com/uk/networking/
OTHER COUNTRIES	+44 - 1933 35 20 00	

Information

Modifications

The FCC requires the user to be notified that any changes or modifications to this device that are not expressly approved by Belkin International, Inc., may void the user's authority to operate the equipment.

Canada-Industry Canada (IC)

The wireless radio of this device complies with RSS 139 & RSS 210 Industry Canada. This Class B digital apparatus complies with Canadian ICES-003.

Cet appareil numérique de la classe B conforme à la norme NMB-003 du Canada.

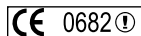

Europe-European Union Notice Radio products with the CE 0682 or CE alert marking comply with the R&TTE Directive (1995/5/EC) issued by the Commission of the European Community.

Compliance with this directive implies conformity to the following European Norms (in brackets are the equivalent international standards).

- EN 60950 (IEC60950) – Product Safety
- EN 300 328 Technical requirement for radio equipment
- ETS 300 826 General EMC requirements for radio equipment.

To determine the type of transmitter, check the identification label on your Belkin product.

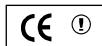

Products with the CE marking comply with the EMC Directive (89/336/EEC) and the Low Voltage Directive (72/23/EEC) issued by the Commission of the European Community. Compliance with these directives implies conformity to the following European Norms (in brackets are the equivalent international standards).

- EN 55022 (CISPR 22) – Electromagnetic Interference
- EN 55024 (IEC61000-4-2,3,4,5,6,8,11) – Electromagnetic Immunity
- EN 61000-3-2 (IEC610000-3-2) – Power Line Harmonics
- EN 61000-3-3 (IEC610000) – Power Line Flicker
- EN 60950 (IEC60950) – Product Safety



Products that contain the radio transmitter are labeled with CE 0682 or CE alert marking and may also carry the CE logo.

Belkin International, Inc., Limited Lifetime Product Warranty

What this warranty covers.

Belkin International, Inc. (“Belkin”) warrants to the original purchaser of this Belkin product that the product shall be free of defects in design, assembly, material, or workmanship.

What the period of coverage is.

Belkin warrants the Belkin product for the lifetime of the product.

What will we do to correct problems?

Product Warranty.

Belkin will repair or replace, at its option, any defective product free of charge (except for shipping charges for the product).

What is not covered by this warranty?

All above warranties are null and void if the Belkin product is not provided to Belkin for inspection upon Belkin’s request at the sole expense of the purchaser, or if Belkin determines that the Belkin product has been improperly installed, altered in any way, or tampered with. The Belkin Product Warranty does not protect against acts of God such as flood, earthquake, lightning, war, vandalism, theft, normal-use wear and tear, erosion, depletion, obsolescence, abuse, damage due to low voltage disturbances (i.e. brownouts or sags), non-authorized program, or system equipment modification or alteration.

How to get service.

To get service for your Belkin product you must take the following steps:

1. Contact Belkin International, Inc., at 501 W. Walnut St., Compton CA 90220, Attn: Customer Service, or call (800)-223-5546, within 15 days of the Occurrence. Be prepared to provide the following information:
 - a. The part number of the Belkin product.
 - b. Where you purchased the product.
 - c. When you purchased the product.
 - d. Copy of original receipt.
2. Your Belkin Customer Service Representative will then instruct you on how to forward your receipt and Belkin product and how to proceed with your claim.

Information

Belkin reserves the right to review the damaged Belkin product. All costs of shipping the Belkin product to Belkin for inspection shall be borne solely by the purchaser. If Belkin determines, in its sole discretion, that it is impractical to ship the damaged equipment to Belkin, Belkin may designate, in its sole discretion, an equipment repair facility to inspect and estimate the cost to repair such equipment. The cost, if any, of shipping the equipment to and from such repair facility and of such estimate shall be borne solely by the purchaser. Damaged equipment must remain available for inspection until the claim is finalized. Whenever claims are settled, Belkin reserves the right to be subrogated under any existing insurance policies the purchaser may have.

How state law relates to the warranty.

THIS WARRANTY CONTAINS THE SOLE WARRANTY OF BELKIN. THERE ARE NO OTHER WARRANTIES, EXPRESSED OR, EXCEPT AS REQUIRED BY LAW, IMPLIED, INCLUDING THE IMPLIED WARRANTY OR CONDITION OF QUALITY, MERCHANTABILITY OR FITNESS FOR A PARTICULAR PURPOSE, AND SUCH IMPLIED WARRANTIES, IF ANY, ARE LIMITED IN DURATION TO THE TERM OF THIS WARRANTY.

Some states do not allow limitations on how long an implied warranty lasts, so the above limitations may not apply to you.

IN NO EVENT SHALL BELKIN BE LIABLE FOR INCIDENTAL, SPECIAL, DIRECT, INDIRECT, CONSEQUENTIAL OR MULTIPLE DAMAGES SUCH AS, BUT NOT LIMITED TO, LOST BUSINESS OR PROFITS ARISING OUT OF THE SALE OR USE OF ANY BELKIN PRODUCT, EVEN IF ADVISED OF THE POSSIBILITY OF SUCH DAMAGES.

This warranty gives you specific legal rights, and you may also have other rights, which may vary from state to state. Some states do not allow the exclusion or limitation of incidental, consequential, or other damages, so the above limitations may not apply to you

EC Declaration of Conformity to R&TTE Directive 1999/5/EC

CE0560 ^①

Manufacturer : BELKIN LTD,
EXPRESS BUSINESS PARK,
SHIPTON WAY
RUSHDEN
NN10 6GL ENGLAND

Representative : Belkin Ltd
(residing in the EC
holding the TCF)

Product / Apparatus : N1 VISION MODEM ROUTER

Type Number : F5D8632-4 V1000

Variants include : All Country variations

Declaration

I declare that above product conforms to all the applicable requirements of EU Directive 1999/5/EC and is CE-marked accordingly:

Article 3.1a: (Standard(s)) used to show compliance with LVD, 73/23/EEC:

EN60950-1:2001+A11: 2004

Article 3.1b: (Standard(s)) used to show compliance with EMC Directive, 89/336/EEC:

EN301 489-1 V1.6.1: 2005, EN301 489-17 V1.2.1: 2002

Article 3.2: Standard(s) used to show compliance:

EN300 328 V1.7.1 (2006) , EN50385 : 2002
Conformity was assessed via Annex IV, using a Technical Construction
File examined by Notified Body **0560**, Telefication.

Signature : 

Name : K Simpson

Title : European Regulatory Compliance Manager

Date : _15 FEB 2008_

BELKIN®

N1 VISION

WIRELESS MODEM ROUTER

BELKIN®

www.belkin.com

Belkin Ltd.

Express Business Park
Shipton Way, Rushden
NN10 6GL, United Kingdom
+44 (0) 1933 35 2000
+44 (0) 1933 31 2000 fax

Belkin SAS

130 rue de Sully
92100 Boulogne-Billancourt
France
+33 (0) 1 41 03 14 40
+33 (0) 1 41 31 01 72 fax

Belkin B.V.

Boeing Avenue 333
1119 PH Schiphol-Rijk
Netherlands
+31 (0) 20 654 73 00
+31 (0) 20 654 73 49 fax

Belkin Iberia

Avda. Cerro del Aguila 3
28700 San Sebastián de los Reyes
Spain
+34 91 625 80 00
+34 902 02 00 34 fax

Belkin GmbH

Hanebergstrasse 2
80637 Munich
Germany
+49 (0) 89 14 34 05 0
+49 (0) 89 14 34 05 100 fax

Belkin Sweden

Knarramäsgatan 7
164 40 Kista
Sweden
+46 (0) 8 5229 1870
+46 (0) 8 5229 1874 fax

P75618uk • F5D8632-4

© 2008 Belkin International, Inc. All rights reserved. All trade names are registered trademarks of respective manufacturers listed. Mac, Mac OS, Apple, and AirPort are trademarks of Apple Inc., registered in the U.S. and other countries. Windows, NT, Microsoft, and Windows Vista are either registered trademarks or trademarks of Microsoft Corporation in the United States and/or other countries.