

BiPAC 5210S
Dual-Port
ADSL2+ Modem/Router

User's Manual

Chapter 1	1
1.1 Introducing the BiPAC 5210S	1
1.2 Features of the BiPAC 5210S	3
Chapter 2	6
2.1 Important note for using the BiPAC 5210S	6
2.2 Package Contents	6
2.3 The Front LEDs	7
2.4 The Rear Ports	8
2.5 Cabling	9
Chapter 3	10
3.1 Before Configuration	10
3.2 Factory Default Settings	23
3.3 LAN and WAN Port Addresses	24
3.4 Information from your ISP	24
3.5 Configuring with your Web Browser	25
Chapter 4	26
4.1 Quick Start	27
4.2 Interface Setup	32
4.3 Advanced Setup	38
4.4 Access Management	47
4.5 Maintenance	53
4.6 Status	58
Chapter 5	63
APPENDIX	65

1.1 Introducing the BiPAC 5210S

Welcome to the BiPAC 5210S. Your router is an “all-in-one” unit, combining an ADSL modem, ADSL router and Ethernet network switch, providing everything you need to get the machines on your network connected to the Internet over your ADSL broadband connection.

The BiPAC 5210S complies with ADSL2+ standards for worldwide deployment and supports downstream rates of up to 24 Mbps and upstream rates of up to 1 Mbps. It is designed for small office, home office and residential users, enabling even faster speed Internet connections. User can enjoy ADSL services and broadband multimedia applications such as interactive gaming, video streaming and real-time audio much easier and faster than ever before.

The product supports PPPoA (RFC 2364 – PPP (Point-to-Point Protocol) over ATM Adaptation Layer 5), RFC 1483 encapsulation over ATM (bridged or routed), PPP over Ethernet (RFC 2516), and IPoA (RFC1577) to establish a connection with ISP. The product also supports VC-based and LLC-based multiplexing.

It is the perfect solution to connect a small group of PCs to a high-speed broadband Internet connection. Multi-users can have high-speed Internet access simultaneously.

This product also serves as an Internet firewall, protecting your network from being accessed by outside users. Not only provide the natural firewall function (Network Address Translation, NAT), it also provides rich firewall features to secure user’s network. All incoming data packets are monitored and filtered. Besides, it can also be configured to block internal users from accessing to the Internet.

The product provides two levels of security support. First, it masks LAN users’ IP addresses which are invisible to outside users on the Internet, making it much more difficult for a hacker to target a machine on your network. Secondly, it can block and redirect certain ports to limit

the services that outside users can access. For example, to ensure that games and other Internet applications will run properly, user can open some specific ports for outside users to access internal services in network.

Integrated DHCP (Dynamic Host Control Protocol) services, client and server, allow multiple users to get their IP addresses automatically on boot up from the product. Simply set local machines as a DHCP client to accept a dynamically assigned IP address from DHCP server and reboot. Each time local machine is powered up; the router will recognize it and assign an IP address to instantly connect it to the LAN.

For advanced users, Virtual Service function allows the product to provide limited visibility to local machines with specific services for outside users. An ISP (Internet Service Providers) provided IP address can be set to the product and then specific services can be rerouted to specific computers on the local network. For instance, a dedicated web server can be connected to the Internet via the product and then incoming requests for HTML that are received by the product can be rerouted to the dedicated local web server, even though the server now has a different IP address. In this example, the product is on the Internet and vulnerable to attacks, but the server is protected.

Virtual Server can also be used to re-task services to multiple servers. For instance, the product can be set to allow separated FTP, Web, and Multiplayer game servers to share the same Internet-visible IP address while still protecting the servers and LAN users from hackers.

1.2 Features of the BiPAC 5210S

● **ADSL Multi-Mode Standard**

supports downstream rates of up to 24 Mbps and upstream rates of up to 1 Mbps. It also supports rate management that allows ADSL subscribers to select an Internet access speed suiting their needs and budgets. It is compliant with Multi-Mode standard (ANSI T1.413, Issue 2; G.dmt(G.992.1); G.lite(G992.2)), G.hs (G994.1), G.dmt.bis (G.992.3), G.dmt.bisplus (G.992.5)). The Annex A and B are supported in different H/W platforms.

● **Fast Ethernet Switch**

A 10/100Mbps fast Ethernet switch is built in with automatic switching between MDI and MDI-X for 10Base-T and 100Base-TX ports. An Ethernet straight or cross-over cable can be used directly for auto detection.

● **Multi-Protocol to Establish A Connection**

Supports PPPoA (RFC 2364 - PPP over ATM Adaptation Layer 5), RFC 1483 encapsulation over ATM (bridged or routed), PPP over Ethernet (RFC 2516) and IPoA (RFC1577) to establish a connection with the ISP. The product also supports VC-based and LLC-based multiplexing.

● **Quick Installation Wizard**

Supports a WEB GUI page to install this device quickly. With this wizard, end users can enter the information easily which they get from their ISP, then surf the Internet immediately.

● **Universal Plug and Play (UPnP) and UPnP NAT Traversal**

This protocol is used to enable simple and robust connectivity among stand-alone devices and PCs from many different vendors. It makes network simple and affordable for users. UPnP architecture leverages TCP/IP and the Web to enable seamless proximity networking in addition to control and data transfer among networked devices. With this feature enabled, users can now connect to Net meeting or MSN Messenger seamlessly.

● **Network Address Translation (NAT)**

Allows multi-users to access outside resources such as the Internet simultaneously with one IP address/one Internet access account. Many application layer gateway (ALG) are supported such as web browser, ICQ, FTP, Telnet, E-mail, News, Net2phone, Ping, NetMeeting, IP phone and others.

● **Firewall**

Supports simple firewall with NAT technology and provides option for blocking access from Internet, like Telnet, FTP, TFTP, WEB, SNMP and IGMP.

- **Domain Name System (DNS) relay**

Provides an easy way to map the domain name (a friendly name for users such as www.yahoo.com) and IP address. When a local machine sets its DNS server with this router's IP address, every DNS conversion request packet from the PC to this router will be forwarded to the real DNS in the outside network.

- **Dynamic Domain Name System (DDNS)**

The Dynamic DNS service allows you to alias a dynamic IP address to a static hostname. This dynamic IP address is the WAN IP address. For example, to use the service, you must first apply for an account from a DDNS service like <http://www.dyndns.org/>.

- **PPP over Ethernet (PPPoE):** Provides embedded PPPoE client function to establish a connection. Users can get greater access speed without changing the operation concept, sharing the same ISP account and paying for one access account. No PPPoE client software is required for local computer. The Automatic Reconnect and Disconnect Timeout (Idle Timer) functions are provided, too.

- **Virtual Server:** User can specify some services to be visible from outside users. The router can detect incoming service request and forward it to the specific local computer to handle it. For example, user can assign a PC in LAN acting as WEB server inside and expose it to the outside network. Outside user can browse inside web server directly while it is protected by NAT. A DMZ host setting is also provided to a local computer exposed to the outside network, Internet.

Users can specify some services to be visible from outside users. The router can detect incoming service requests and forward either a single port or a range of ports to the specific local computer to handle it. For example, a user can assign a PC in the LAN acting as a WEB server inside and expose it to the outside network. Outside users can browse inside web servers directly while it is protected by NAT. A DMZ host setting is also provided to a local computer exposed to the outside network, Internet.

- **Dynamic Host Configuration Protocol (DHCP) client and server**

In the WAN site, the DHCP client can get an IP address from the Internet Service Provider (ISP) automatically. In the LAN site, the DHCP server can allocate a range of client IP addresses and distribute them including IP address, subnet mask as well as DNS IP address to local computers. It provides an easy way to manage the local IP network.

- **RIP1/2 Routing**

Supports RIP1/2 routing protocol for routing capability.

- **Simple Network Management Protocol (SNMP)**

It is an easy way to remotely manage the router via SNMP.

- **Web based GUI**

Supports web based GUI for configuration and management. It is user-friendly and comes with on-line help. It also supports remote management capability for remote users to configure and manage this product.

- **Firmware Upgradeable**

Device can be upgraded to the latest firmware through the WEB based GUI.

2.1 Important note for using the BiPAC 5210S



Warning

- ✓ Do not use the BiPAC 5210S in high humidity or high temperatures.
- ✓ Do not use the same power source for the BiPAC 5210S as other equipment.
- ✓ Do not open or repair the case yourself. If the BiPAC 5210S is too hot, turn off the power immediately and have it repaired at a qualified service center.
- ✓ Avoid using this product and all accessories outdoors.



Attention

- ✓ Place the BiPAC 5210S on a stable surface.
- ✓ Only use the power adapter that comes with the package. Using a different voltage rating power adaptor may damage the router.

2.2 Package Contents

- BiPAC 5210S ADSL2+ Modem/Router
- CD-ROM containing the online manual
- RJ-11 ADSL/telephone Cable (1.8M)
- Ethernet (CAT-5 LAN) Cable (2M Straight)
- USB Cable (1.5M)
- AC-AC power adapter (12V AC, 1A)
- Quick Start Guide (105*150*mm)

2.3 The Front LEDs

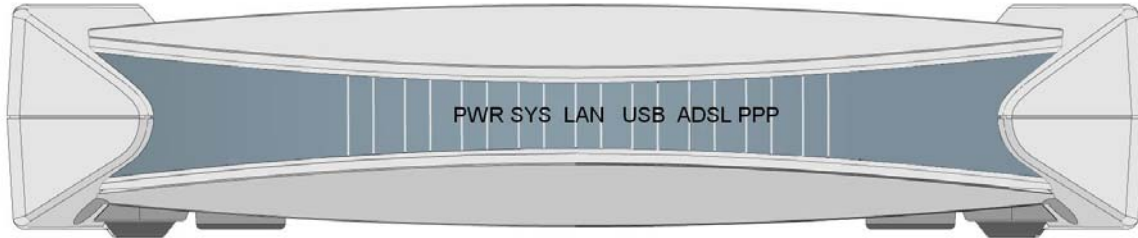

LED		Meaning
1	PPP :	● Lit steady when there is a PPPoA / PPPoE connection.
2	ADSL:	● Lit when successfully connected to an ADSL DSLAM ("linesync")
3	USB:	● Lit when the USB port is connected to the PC and working properly
4	LAN Port :	<ul style="list-style-type: none"> ● Lit when connected to an Ethernet device. ● Green for 100Mbps; Orange for 10Mbps. ● Blinking when data is Transmitted / Received.
5	SYS :	● Lit when the system is ready.
6	PWR :	● Lit when power is ON.

2.4 The Rear Ports

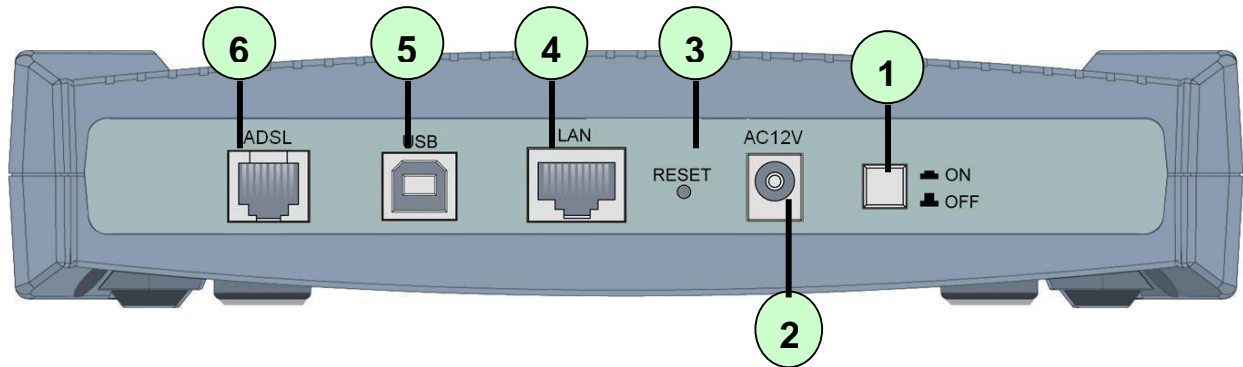

Port		Meaning
1	Power Switch	Power ON/OFF switch
2	POWER	Connect the supplied power adapter to this jack.
3	RESET	After the device is powered on, press it to reset the device or restore to factory default settings. 0-3 seconds : reset the device 6 seconds above : restore to factory default settings (this is used when you can not login to the router, e.g. forgot the password)
4	LAN	Connect a UTP Ethernet cable (Cat-5 or Cat-5e) to the LAN ports when connecting to a PC or an office/home network of 10Mbps or 100Mbps.
5	USB	Connect the supplied USB cable to this port when connecting to the PC
6	ADSL	Connect the supplied RJ-11 ("telephone") cable to this port when connecting to the ADSL/telephone network.

2.5 Cabling

Through USB Port

The product can be used as a Network Adapter on your PC. That means you do not have to install a network adapter first on your PC before connecting the ADSL Modem/Router. Just connect the supplied USB cable to the USB port of the ADSL2+ Modem/Router and connect the other end to the PC.

Make sure that your ADSL Modem/Router and PC are turned on. On the front of the product is a bank of LEDs. As a first check, please verify that the PWR, SYS, USB and ADSL LEDs are lit.

So long as the cables are connected and the LEDs are lit normally, follow section ***“Installing the USB Driver”*** below to setup this device.

Through Ethernet Port

The product’s LAN port is wired just like a Network Adapter’s port. From the product directly to a PC, the cable should be an Ethernet crossover cable. From the product to a hub or switch, the cable should be an Ethernet straight through cable to a normal hub/switch port, or an Ethernet crossover cable to an uplink port.

The most common problem associated with Ethernet is bad cabling or ADSL line. Make sure that all connected devices are turned on. On the front of the product is a bank of LEDs. As a first check, please verify that the PWR, LAN LNK and ADSL SYN LEDs are lit. If they are not, verify that you are using the proper cables.

So long as the cables are connected and the LEDs are lit normally, follow section ***“Configuring the Network Properties”*** below to modify the network settings.



Attention

- ✓ **Since the product cannot auto-detect whether your cable is correct or not, please make sure you are using the right cable to a PC or a Hub..**

Chapter 3

Basic Installation

The router can be configured with your web browser. A web browser is included as a standard application in the following operating systems: Windows 98/NT/2000/XP/Me, etc. The product provides a very easy and user-friendly interface for configuration.

3.1 Before Configuration

PCs must have an Ethernet interface installed properly and be connected to the router either directly or through an external repeater hub, and have TCP/IP installed and configured to obtain an IP address through a DHCP server or a fixed IP address that must be in the same subnet as the router. The default IP address of the router is **192.168.1.254** and the subnet mask is **255.255.255.0** (i.e. any attached PC must be in the same subnet, and have an IP address in the range of 192.168.1.1 to 192.168.1.253). The best and easiest way is to configure the PC to get an IP address automatically from the router using DHCP. If you encounter any problems accessing the router's web interface it may also be advisable to **uninstall** any kind of software firewall on your PCs, as they can cause problems accessing the 192.168.1.254 IP address of the router. Users should make their own decisions on how to best protect their network.

Please follow the steps below for your PC's network environment installation. First of all, please check your PC's network components. The TCP/IP protocol stack and Ethernet network adapter must be installed. If not, please refer to your Windows-related or other operating system manuals.



Any TCP/IP capable workstation can be used to communicate with or through the ADSL2+ Modem/Router. To configure other types of workstations, please consult the manufacturer's documentation.

Installing the USB Driver

If you connect the device through USB port instead of Ethernet port, for the first time the USB cable is connected to the PC, Windows will automatically detect the device. Follow the steps to install the USB driver.

For Windows XP & 2000 :

1. Start Windows. Then insert the installation CD into the CD-ROM drive. In next window, to specify the driver directory such as "G:\USB Driver\setupXP2K_En_De_Fi" and to continue.

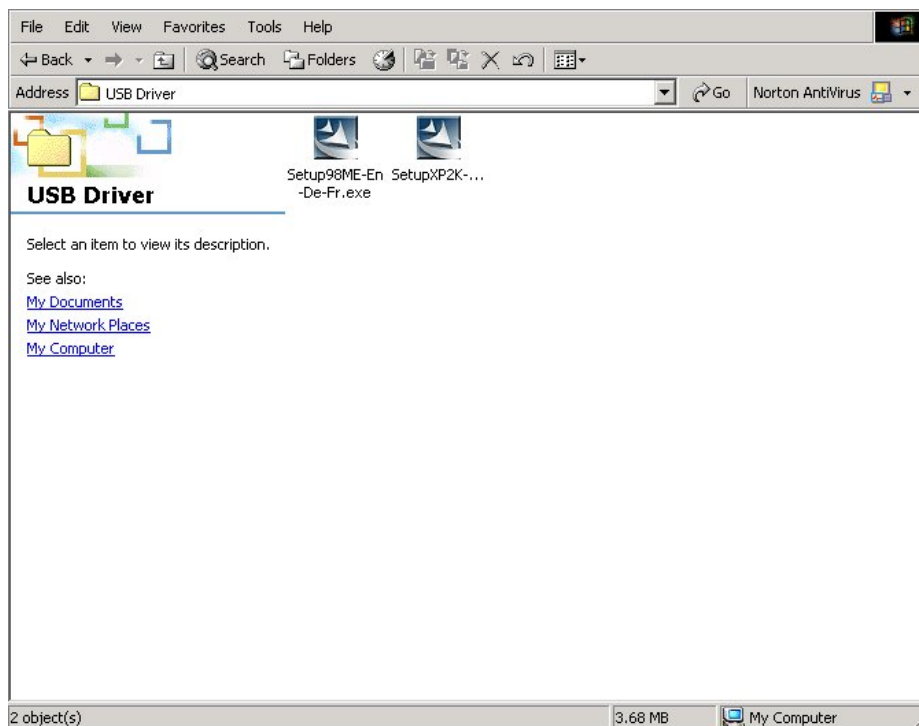

2. To choose the setup language. "and click "Next >". (There are three languages that user can choose: English. German and French)

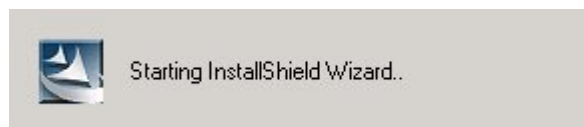

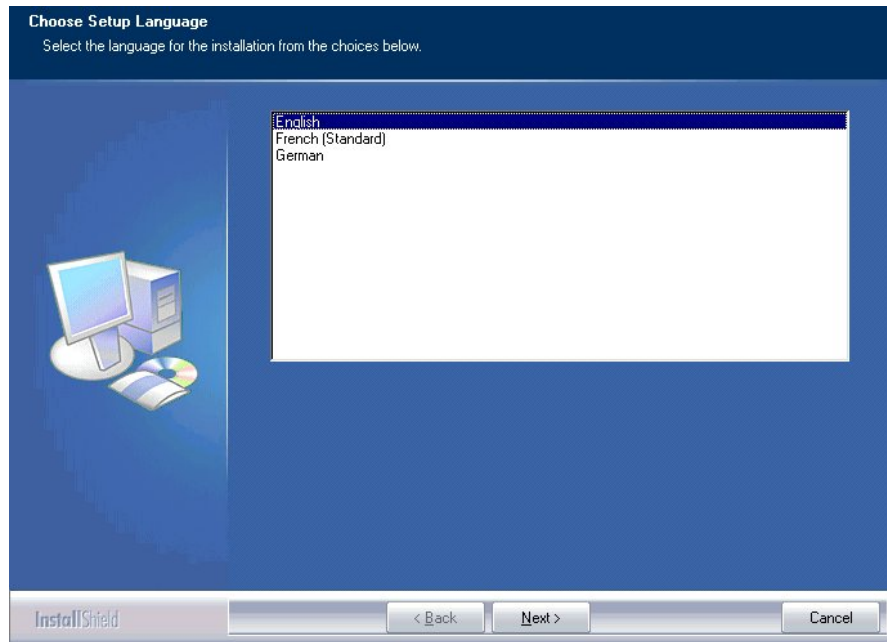

3. Then follow screen.

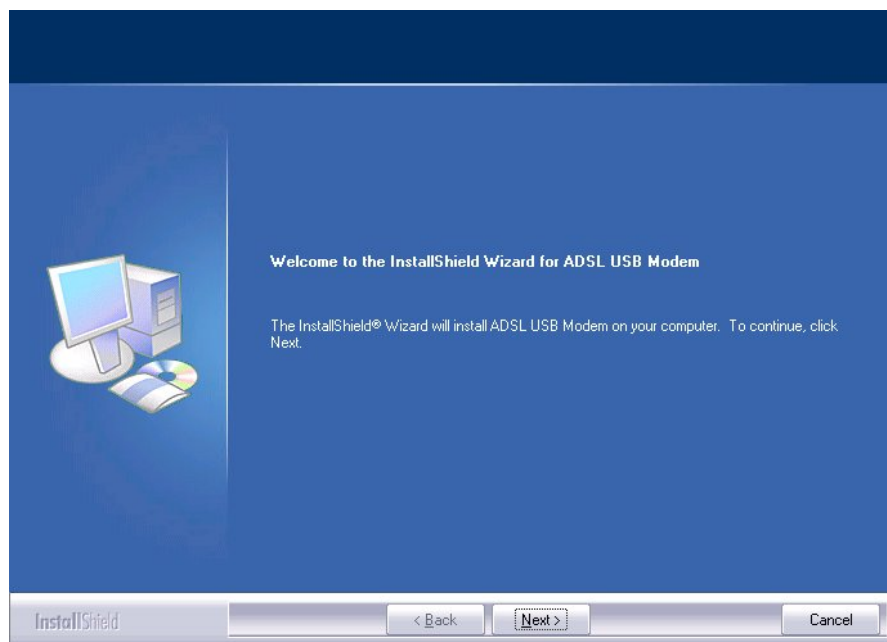

4. To click the type of setup you prefer, then click Next >.

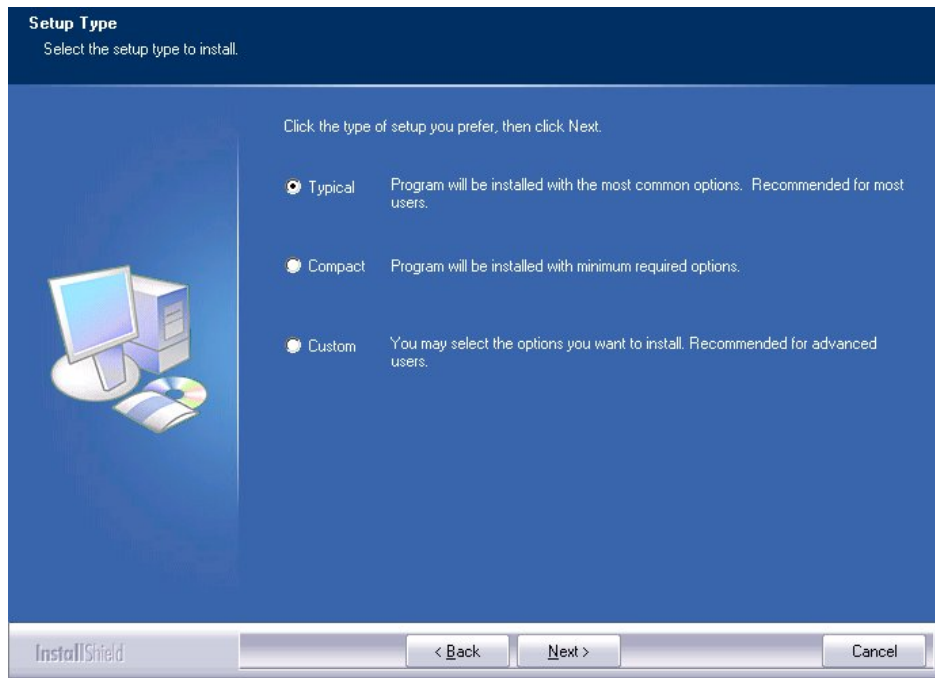

5. To setup enough information of copying the program files then click Next >.

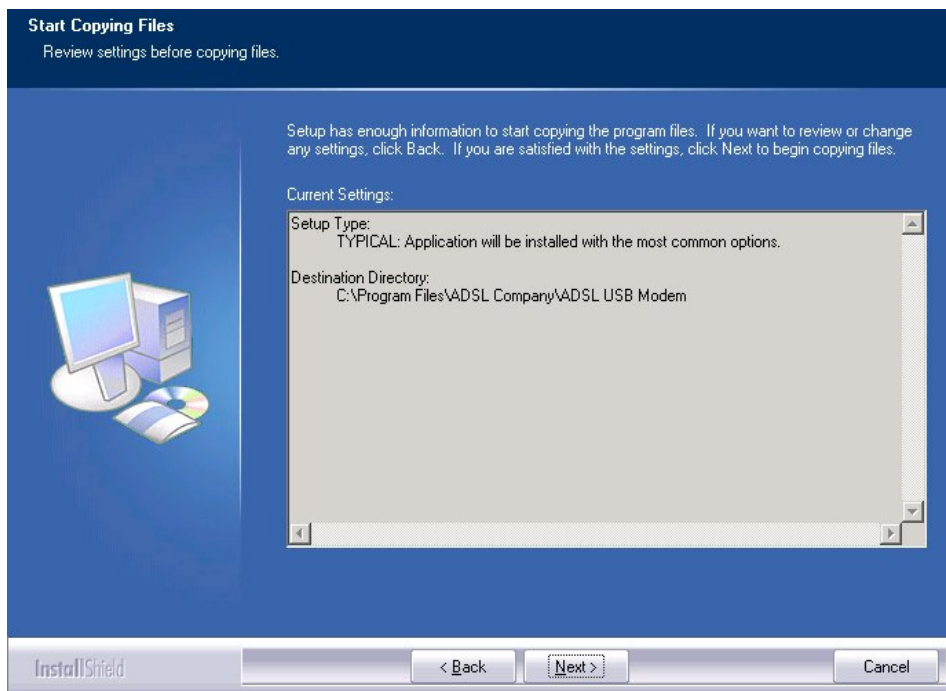

6. Please plug USB cable into ADSL USB Modem.

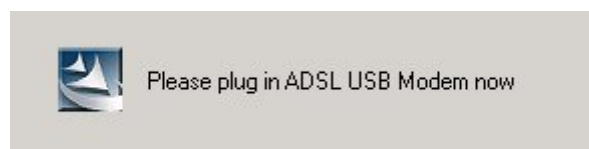

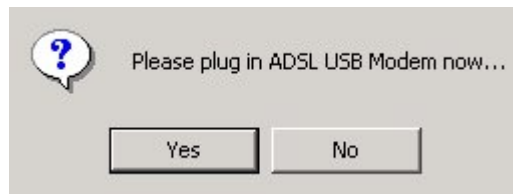

7. Then, click "Finish".

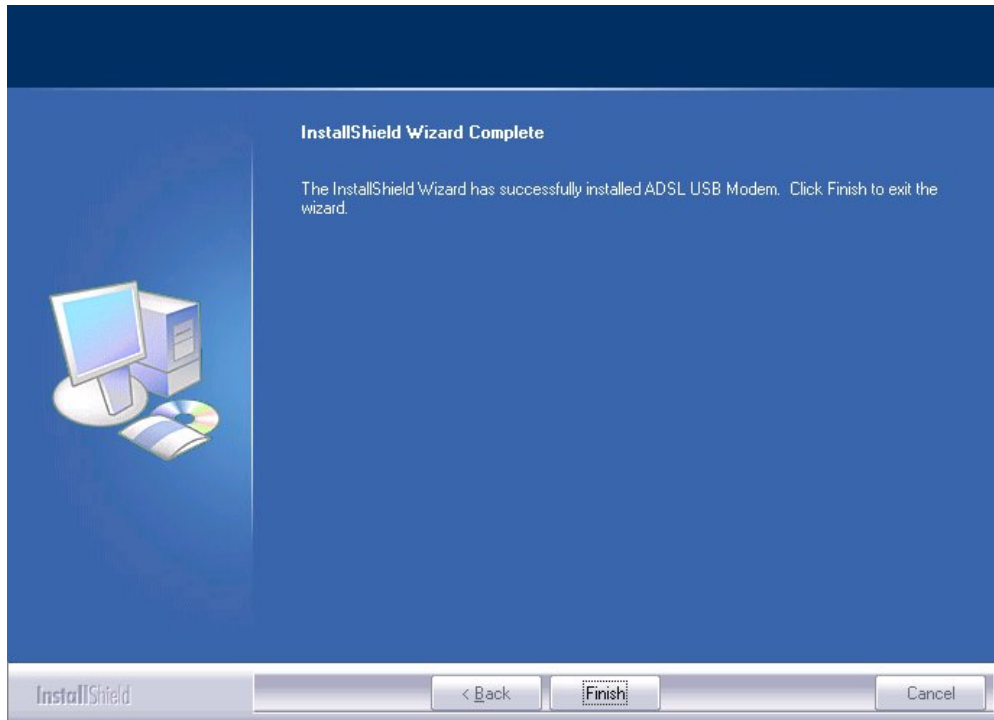

For Windows 98 & Me :

1. Start Windows. Then insert the installation CD into the CD-ROM drive. In next window, to specify the driver directory such as “G:\USB Driver\setup98 Me_En_De_Fi” and to continue.

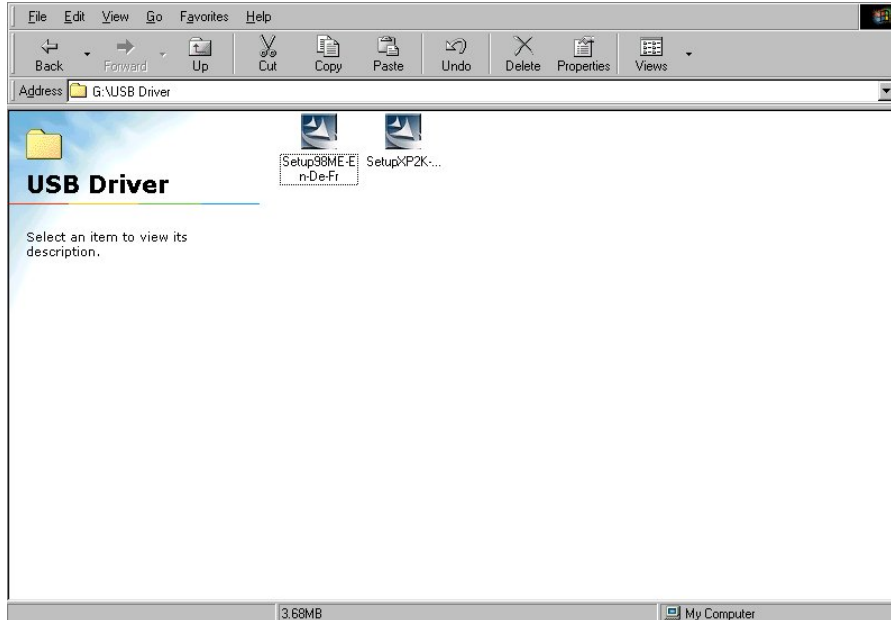

2. To choose the setup language. ”and click “Next >”. (There are three languages that user can choose: English. German and French)



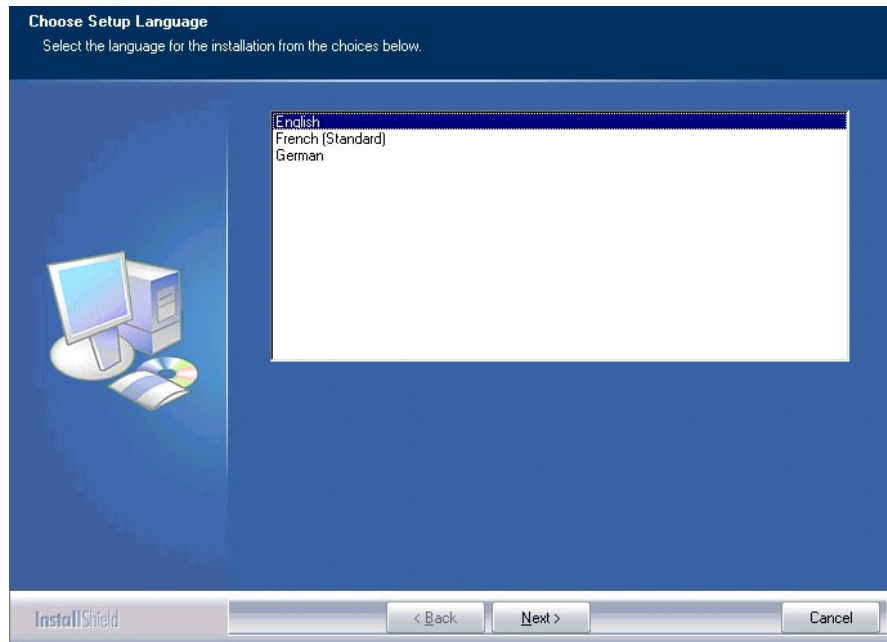

3. Then follow screen.

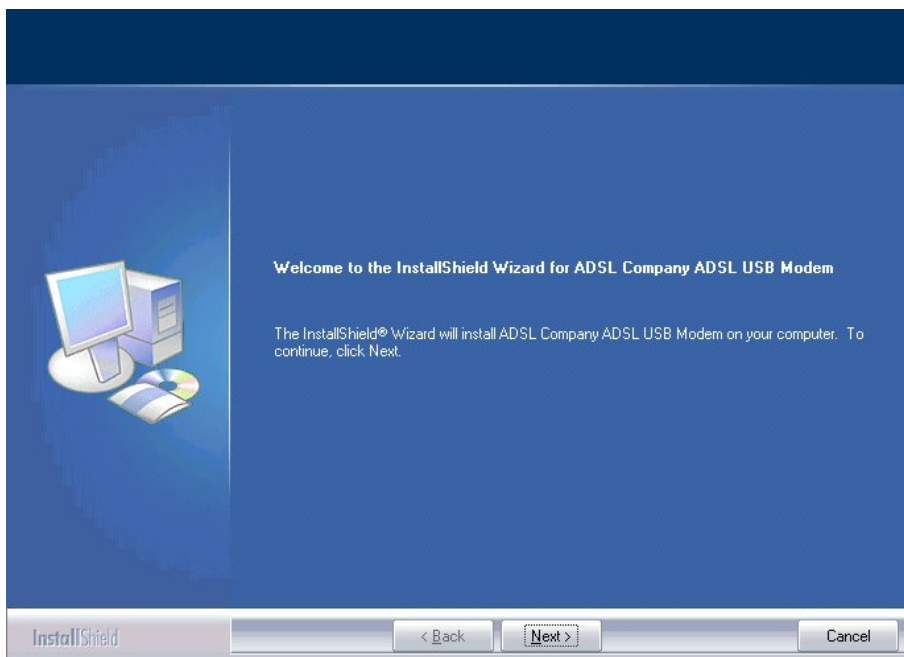

4. To click the type of setup you prefer, then click Next >.

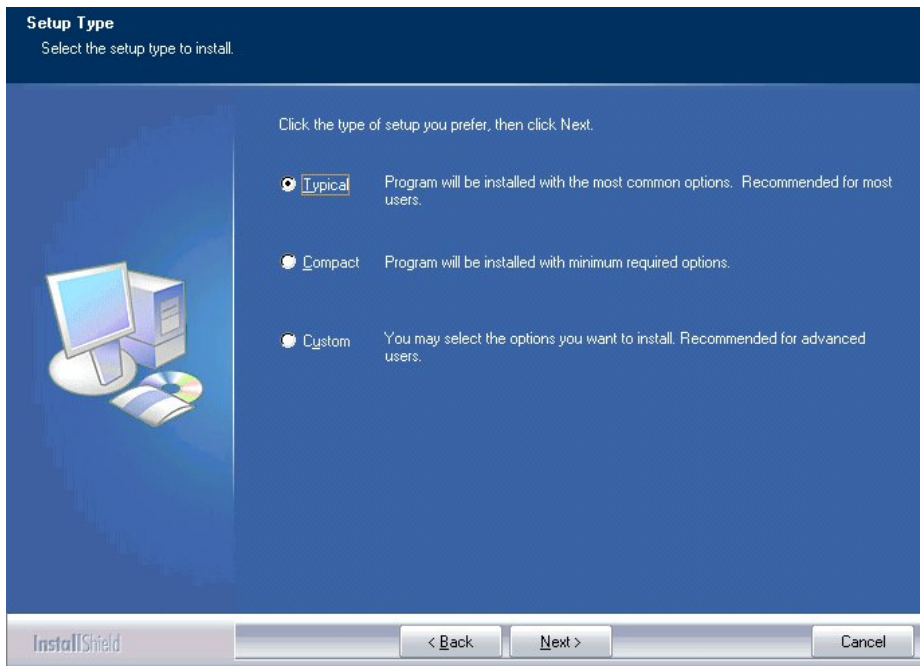

5. To setup enough information of copying the program files.

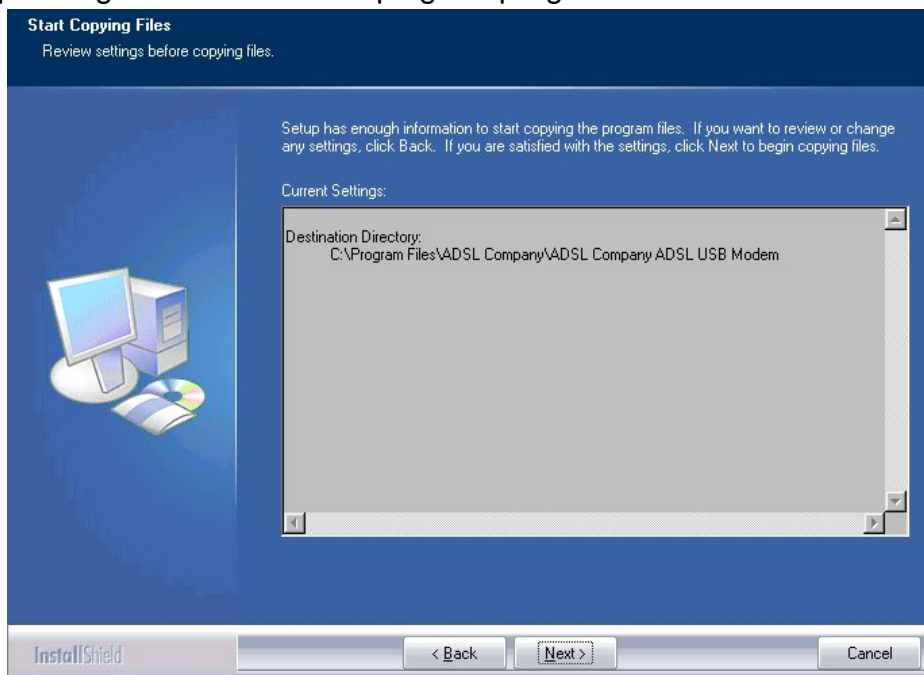

6. Select "Want to restart my computer now" and click OK>

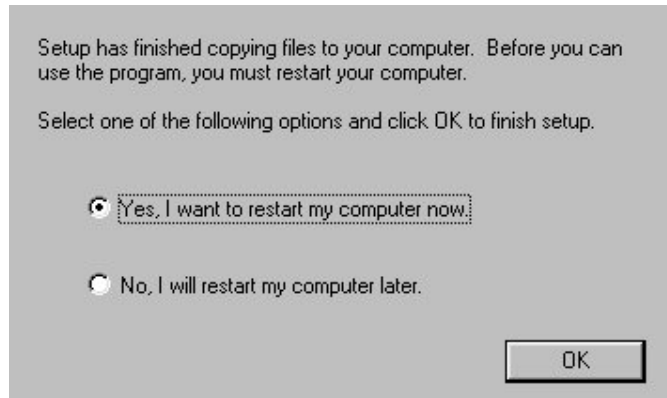

7. Then, click "Finish".

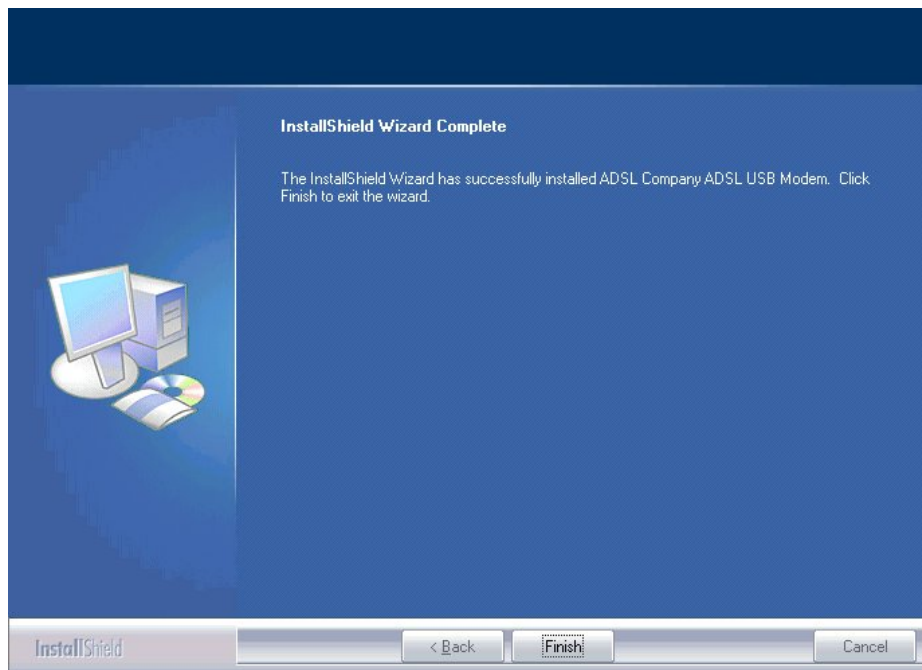

Configuring the Network Properties Configuring PC in Windows XP

1. Go to **Start / Control Panel (in Classic View)**. In the Control Panel, double-click on **Network Connections**
2. Double-click **Local Area Connection**.
3. In the **Local Area Connection Status** window, click **Properties**.
4. Select **Internet Protocol (TCP/IP)** and click **Properties**.
5. Select the **Obtain an IP address automatically** and the **Obtain DNS server address automatically** radio buttons.
6. Click **OK** to finish the configuration.

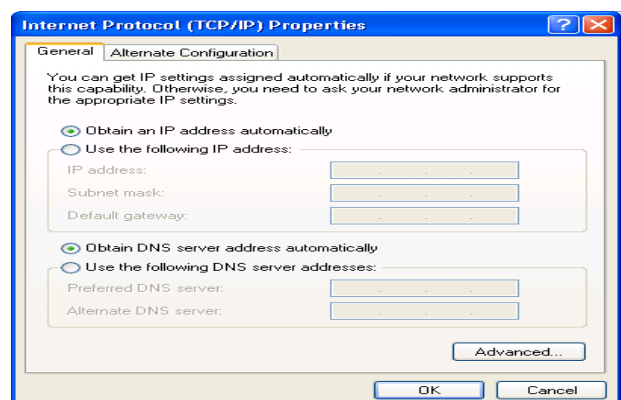
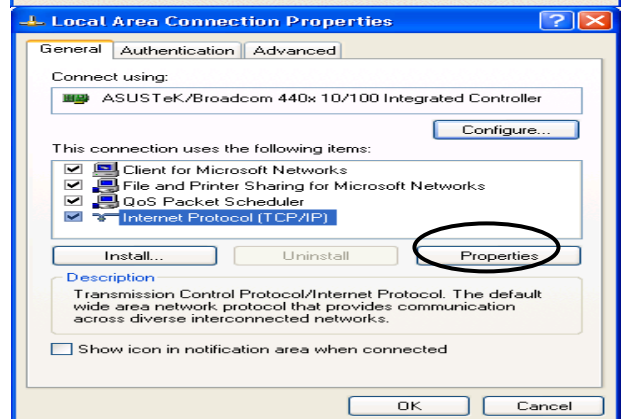
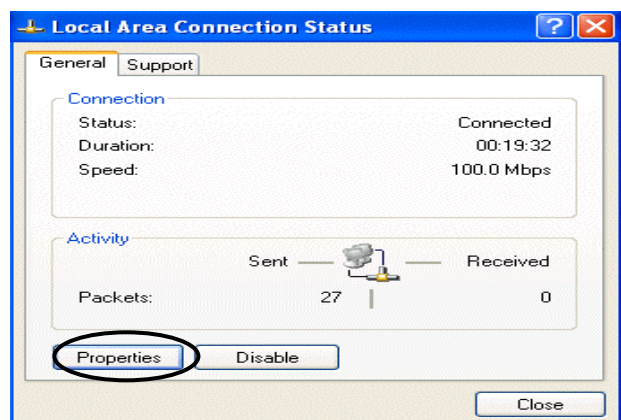
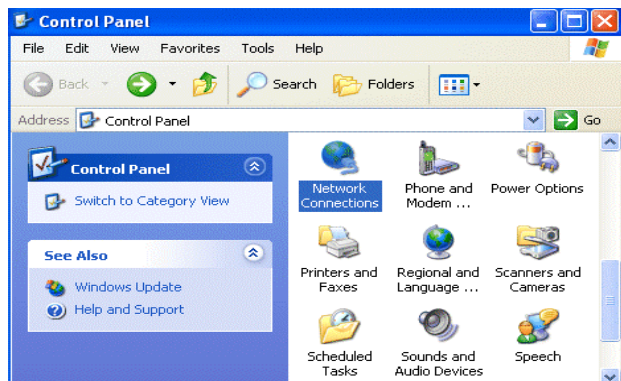

Configuring PC in Windows 2000

1. Go to **Start / Settings / Control Panel**. In the Control Panel, double-click on **Network and Dial-up Connections**.
2. Double-click **Local Area Connection**.

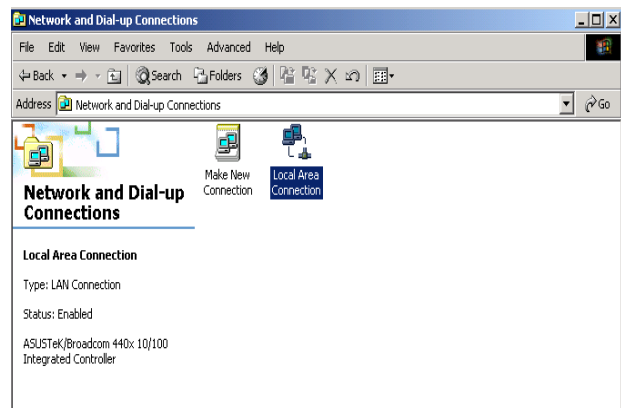

3. In the **Local Area Connection Status** window click **Properties**.

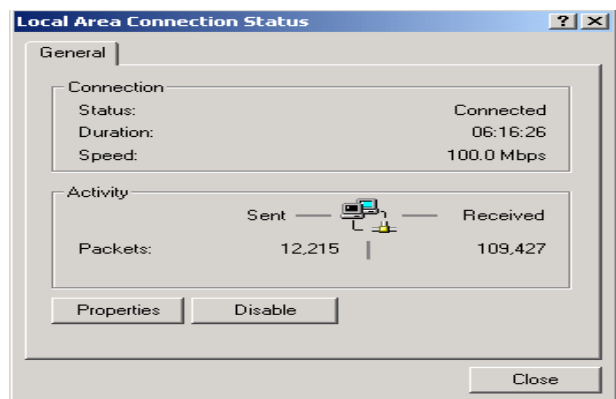

4. Select **Internet Protocol (TCP/IP)** and click **Properties**.

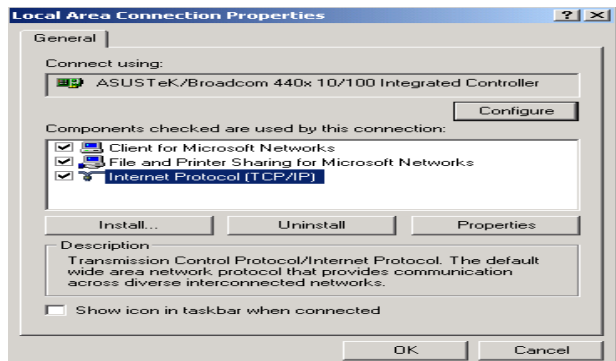

5. Select the **Obtain an IP address automatically** and the **Obtain DNS server address automatically** radio buttons.

6. Click **OK** to finish the configuration.

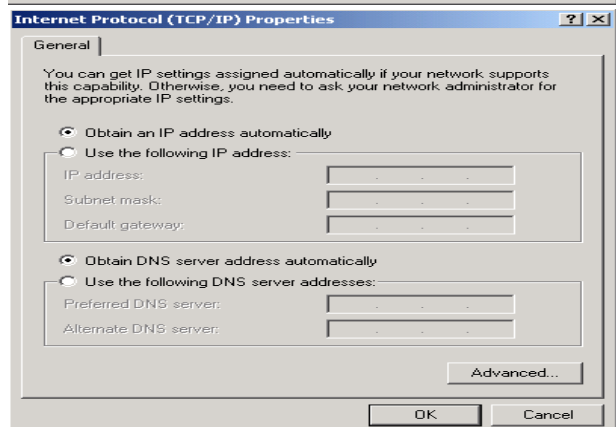

Configuring PC in Windows 98/Me

1. Go to **Start / Settings / Control Panel**. In the Control Panel, double-click on **Network** and choose the **Configuration** tab.
2. Select **TCP/IP ->NE2000 Compatible**, or the name of your Network Interface Card (NIC) in your PC.

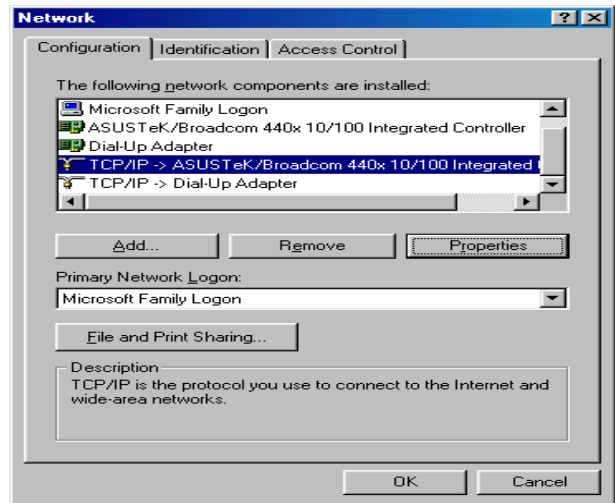

3. Select the **Obtain an IP address automatically** radio button.

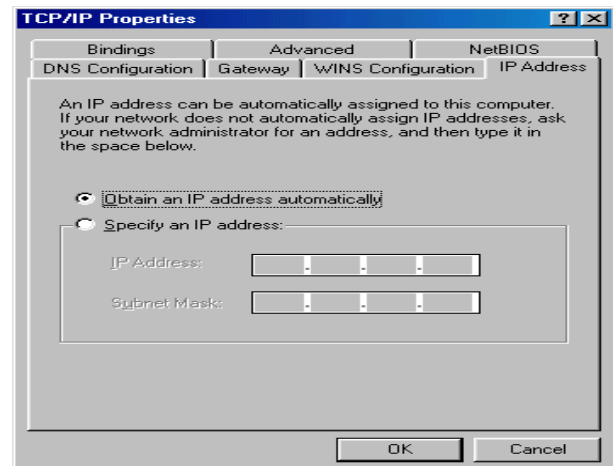

4. Then select the **DNS Configuration** tab.
5. Select the **Disable DNS** radio button and click **OK** to finish the configuration.

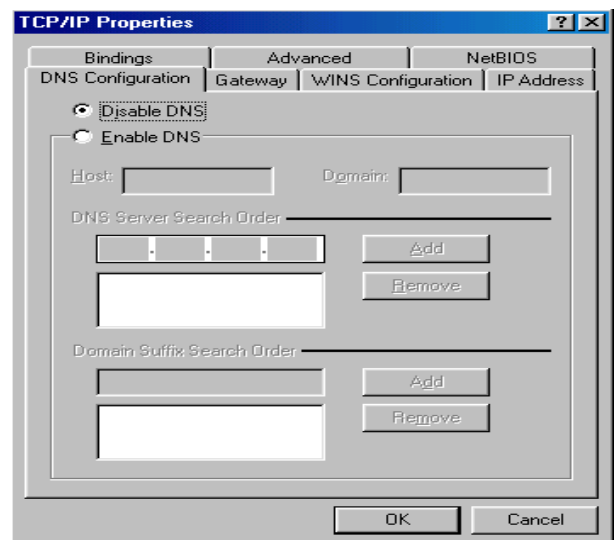

Configuring PC in Windows NT4.0

1. Go to **Start / Settings / Control Panel**. In the Control Panel, double-click on **Network** and choose the **Protocols** tab.
2. Select **TCP/IP Protocol** and click **Properties**.

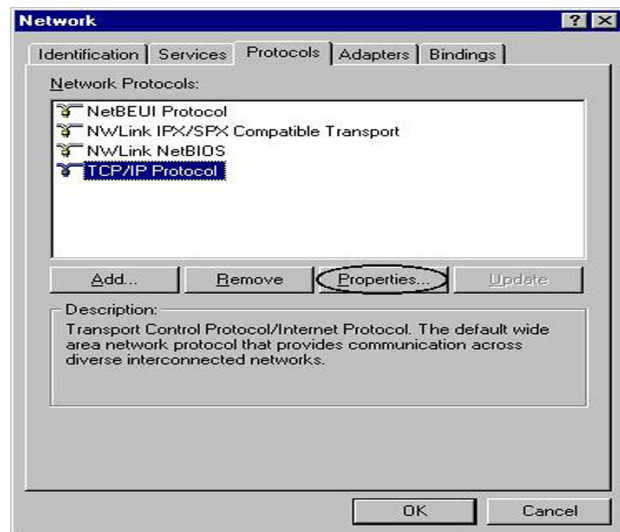

3. Select the **Obtain an IP address from a DHCP server** radio button and click **OK**.

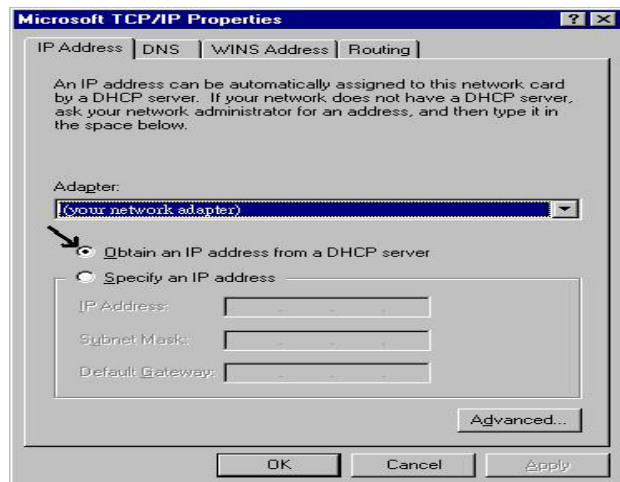

NOTE:

If you configuring the Network Properties through USB Port, please be note to specify a DNS IP address in PC and do not use “Obtain DNS server address automatically”

3.2 Factory Default Settings

Before configuring your, you need to know the following default settings.

● Web Interface:

- ✘ Username: admin
- ✘ Password: admin

● LAN Device IP Settings:

- ✘ IP Address: 192.168.1.254
- ✘ Subnet Mask: 255.255.255.0

● ISP setting in WAN site:

- ✘ PPPoE

● DHCP server:

- ✘ DHCP server is enabled.
- ✘ Start IP Address: 192.168.1.100
- ✘ IP pool counts: 100

3.2.1 Username and Password

The default username and password are “**admin**” and “**admin**” respectively.



Attention

If you ever forget the password to log in, you may press the RESET button up to 6 seconds to restore the factory default settings.

3.3 LAN and WAN Port Addresses

The parameters of LAN and WAN ports are pre-set in the factory. The default values are shown below.

LAN Port		WAN Port
IP address	192.168.1.254	The PPPoE function is <i>enabled</i> to automatically get the WAN port configuration from the ISP, but you have to set the username and password first.
Subnet Mask	255.255.255.0	
DHCP server function	Enabled	
IP addresses for distribution to PCs	100 IP addresses continuing from 192.168.1.100 through 192.168.1.199	

3.4 Information from your ISP

Before configuring this device, you have to check with your ISP (Internet Service Provider) what kind of service is provided such as PPPoE, PPPoA, RFC1483, or IPoA.

Gather the information as illustrated in the following table and keep it for reference.

PPPoE	VPI/VCI, VC-based/LLC-based multiplexing, Username, Password, Service Name, and Domain Name System (DNS) IP address (it can be automatically assigned by your ISP when you connect or be set manually).
PPPoA	VPI/VCI, VC-based/LLC-based multiplexing, Username, Password, and Domain Name System (DNS) IP address (it can be automatically assigned by your ISP when you connect or be set manually).
RFC1483 Bridged	VPI/VCI, VC-based/LLC-based multiplexing to use Bridged Mode.
RFC1483 Routed	VPI/VCI, VC-based/LLC-based multiplexing, IP address, Subnet mask, Gateway address, and Domain Name System (DNS) IP address (it is fixed IP address).

3.5 Configuring with your Web Browser

Open your web browser, enter the IP address of your router, which by default is **192.168.1.254**, and click **“Go”**, a user name and password window prompt will appear. **The default username and password are “admin” and “admin”.**

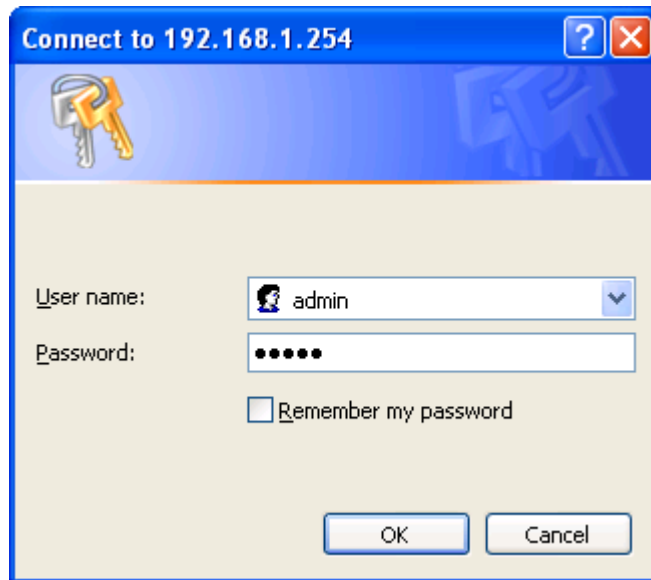

Congratulation! You are now successfully logon to the ADSL2+ Modem/Router!

Chapter 4

Configuration

At the configuration homepage, the left navigation pane where bookmarks are provided links you directly to the desired setup page, including:

- **Quick Start** (wizard setup)
- **Interface Setup** (Internet, LAN)
- **Advanced Setup** (Firewall, Routing, NAT, ADSL)
- **Access Management** (ACL, IP Filter, SNMP, UPnP, DDNS)
- **Maintenance** (Administration, Time Zone, Firmware, SysRestart, Diagnostics)
- **Status**

Please see the relevant sections of this manual for detailed instructions on how to configure your Billion router.

4.1 Quick Start

The screenshot displays the web interface for a BILLION ADSL Modem/Router. At the top left is the 'BILLION' logo. To the right of the logo, the text 'ADSL Modem/Router' is visible. Below the logo, there is a navigation menu with the following items: 'Quick Start', 'Interface Setup', 'Advanced Setup', 'Access Management', 'Maintenance', 'Status', and 'Help'. The 'Quick Start' item is highlighted in a darker blue. Below the navigation menu, there is a main content area with a blue header that says 'Quick Start'. The main content area contains the following text: 'This ADSL Router is ideal for home networking and small business networking. The 'Quick Start' wizard will guide you to configure the ADSL router to connect to your ISP (Internet Service Provider). The router's easy Quick Start will allow you to have Internet access within minutes. Please follow the 'Quick Start' wizard step by step to configure the ADSL Router.' At the bottom of the main content area, there is a blue bar with a button labeled 'RUN WIZARD'.

For detailed instructions on configuring WAN settings, see the **Interface Setup** section of this manual.

The information you need for the Quick Start to get you online are your login (often in the form of *username@ispname*), your password, and the encapsulation type.

The following is the Quick Start step, please follow according to the instruction step by step.



Quick Start

The Wizard will guide you through these four quick steps. Begin by clicking on **NEXT**.

- Step 1. Set your new password
- Step 2. Choose your time zone
- Step 3. Set your Internet connection
- Step 4. Re-start your ADSL router

[NEXT](#) [EXIT](#)

Step1. Set your new password.



Quick Start - Password

You may change the **admin** account password by entering in a new password. Click **NEXT** to continue.

New Password :

Confirmed Password :

[BACK](#) [NEXT](#) [EXIT](#)

Step2: Choose your time zone

BILLION

Quick Start - Time Zone

Select the appropriate time zone for your location and click **NEXT** to continue.

(GMT) Greenwich Mean Time : Dublin, Edinburgh, Lisbon, London

BACK

NEXT

EXIT

Step3: Set your Internet connection

BILLION

Quick Start - ISP Connection Type

Select the internet connection type to connect to your ISP. Click **NEXT** to continue.

- Dynamic IP Address Choose this option to obtain a IP address automatically from your ISP.
- Static IP Address Choose this option to set static IP information provided to you by your ISP.
- PPPoE/PPPoA Choose this option if your ISP uses PPPoE/PPPoA. (For most DSL users)
- Bridge Mode Choose this option if your ISP uses Bridge Mode.

BACK

NEXT

EXIT



Quick Start - PPPoE/PPPoA

Enter the PPPoE/PPPoA information provided to you by your ISP. Click **NEXT** to continue.

Username:

Password:

VPI: (0~255)

VCI: (1~65535)

Connection Type: 

BACK

NEXT

EXIT



Quick Start Complete !!

The Setup Wizard has completed. Click on **BACK** to modify changes or mistakes. Click **NEXT** to save the current settings.

BACK

NEXT

EXIT

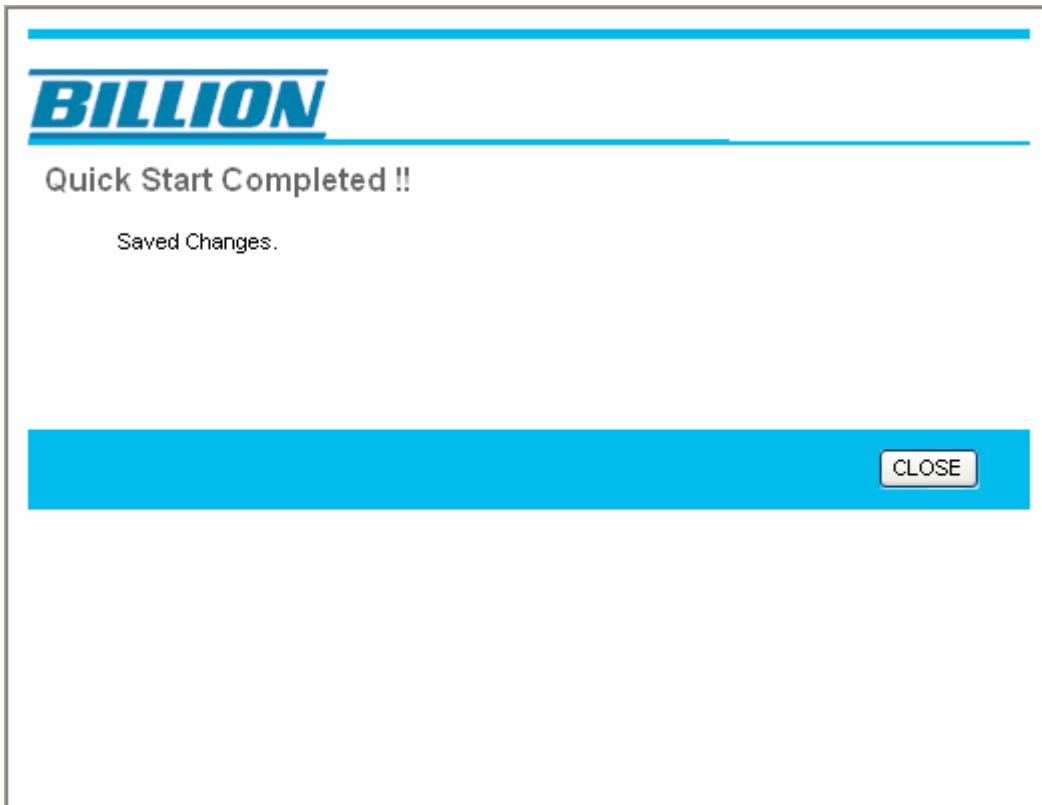

Step4: Restart your ADSL Router

4.2 Interface Setup

Click this item to access the following sub-items that configure the ADSL router: **Internet, LAN**

These functions are described in the following sections.

4.2.1 Internet

Interface	Quick Start	Interface Setup	Advanced Setup	Access Management	Maintenance	Status	Help
	Internet	LAN					
ATM VC	Virtual Circuit : PVC0 <input type="button" value="PVCs Summary"/> Status : <input checked="" type="radio"/> Activated <input type="radio"/> Deactivated VPI : 8 (range: 0~255) VCI : 35 (range: 1~65535)						
QoS	ATM QoS : UBR <input type="button" value="QoS Summary"/> PCR : 0 cells/second SCR : 0 cells/second MBS : 0 cells						
Encapsulation	ISP : <input type="radio"/> Dynamic IP Address <input type="radio"/> Static IP Address <input checked="" type="radio"/> PPPoE/PPPoA <input type="radio"/> Bridge Mode						
PPPoE/PPPoA	Username : <input type="text" value="username"/> Password : <input type="password" value="*****"/> Encapsulation : PPPoE LLC <input type="button" value="Encapsulation Summary"/> Bridge Interface : <input type="radio"/> Activated <input checked="" type="radio"/> Deactivated						
Connection Setting	Connection : <input checked="" type="radio"/> Always On (Recommended) <input type="radio"/> Connect On-Demand (Close if idle for <input type="text" value="0"/> minutes) TCP MSS Option : TCP MSS(0 means use default) <input type="text" value="0"/> bytes						
IP Address	Get IP Address : <input type="radio"/> Static <input checked="" type="radio"/> Dynamic Static IP Address : <input type="text" value="0.0.0.0"/> IP Subnet Mask : <input type="text" value="0.0.0.0"/> Gateway : <input type="text" value="0.0.0.0"/> NAT : Enable <input type="button" value="NAT Summary"/> Default Route : <input checked="" type="radio"/> Yes <input type="radio"/> No TCP MTU Option : TCP MTU(0 means use default) <input type="text" value="0"/> bytes Dynamic Route : RIP1 <input type="button" value="Dynamic Route Summary"/> Direction None <input type="button" value="Dynamic Route Summary"/> Multicast : Disabled <input type="button" value="Multicast Summary"/>						
<input type="button" value="SAVE"/>							

■ ATM VC

● **Virtual Circuit:** VPI (Virtual Path Identifier) and VCI (Virtual Channel Identifier) define a virtual circuit.

● **VPI:** The valid range for the VPI is 0 to 255. Enter the VPI assigned to you. This field may already be configured.

● **VCI:** The valid range for the VCI is 32 to 65535. Enter the VCI assigned to you. This field may already be configured.

● **ATM QoS:** Select **CBR** to specify fixed (always-on) bandwidth for voice or data traffic. Select **UBR** for applications that are non-time sensitive, such as e-mail. Select **VBR** for burst traffic and bandwidth sharing with other applications.

● **PCR:** Divide the DSL line rate (bps) by 424 (the size of an ATM cell) to find the Peak Cell Rate (PCR). This is the maximum rate at which the sender can send cells.

● **SCR:** The Sustain Cell Rate (SCR) sets the average cell rate (long-term) that can be transmitted.

● **MBS:** Maximum Burst Size (MBS) refers to the maximum number of cells that can be sent at the peak rate. Type the MBS, which is less than 65535

■ **Encapsulation:**

● **ISP:** Select the encapsulation type your ISP uses from the **Encapsulation** list.

Choices vary depending on what you select in the **Mode** field.

If you select **Bridge** in the **Mode** field, select **1483 Bridged IP**.

If you select Routing in the Mode field, select PPPoA, 1483 Bridged IP, 1483 Router IP or PPPoE.

■ **PPPoE/PPPoA**

● **User Name:** Enter the user name exactly as your ISP assigned.

● **Password:** Enter the password associated with the user name above.

● **Encapsulation:** select Bridge in the Mode field, select either PPPoA or RFC 1483. select Routing in the Mode field, select PPPoA, RFC 1483, ENET ENCAP or PPPoE.

Multiplex: Select the method of multiplexing used by your ISP. Choices are VC or LLC.

● **Connection:** The schedule rule(s) have priority over your Connection settings.

Always on: Select Always on Connection when you want your connection up all the time.

Connect on Demand: Select Connect on Demand when you don't want the connection up all the time and specify an idle time-out in the Max Idle Timeout field

● **Get IP Address:** Choose Static or Dynamic

● **Static IP Address:** Enter the IP address of ADSL Router in dotted decimal notation, for example, 192.168.1.254 (factory default).

● **IP Subnet Mask:** The default is 255.0.0.0. User can change it to other such as 255.255.255.0. Type the subnet mask assigned to you by your ISP (if given).

● **Gateway:** You must specify a gateway IP address (supplied by your ISP) when you use **1483 Bridged IP** in the **Encapsulation** field in the previous screen.

● **Network Address Translation:** Select **None**, **Many to One** or **Many to Many** from the drop-down list box. Refer to the NAT chapter for more details.

● **Dynamic Route:**

RIP Version: Select the RIP version from RIP-1, RIP-2B and RIP-2M.

RIP Direction: Select the RIP direction from None, Both, In Only and Out Only.

● **Multicast:** IGMP (Internet Group Multicast Protocol) is a network-layer protocol used to establish membership in a Multicast group - it is not used to carry user data. The BiPAC 5200 Series supports both IGMP version 1 (IGMP-v1) and IGMP-v2. Select None to disable it

4.2.2 LAN

A Local Area Network (LAN) is a shared communication system to which many computers are attached and is limited to the immediate area, usually the same building or floor of a building.

BILLION ADSL Modem/Router

Interface | Quick Start | **Interface Setup** | Advanced Setup | Access Management | Maintenance | Status | Help

Internet | **LAN**

Router Local IP

IP Address : 192.168.1.254
IP Subnet Mask : 255.255.255.0
Dynamic Route : RIP1 | Direction : None
Multicast : Disabled

DHCP

DHCP : Disabled Enabled Relay

DHCP Server

Starting IP Address : 192.168.1.100
IP Pool Count : 100
Lease Time : 86400 seconds (0 sets to default value of 259200)

DNS

DNS Relay : Use Auto Discovered DNS Server Only
Primary DNS Server : N/A
Secondary DNS Server : N/A

SAVE CANCEL

Router Local IP

● **IP Address:** Enter the IP address of ADSL Router in dotted decimal notation, for example, 192.168.1.254 (factory default).

● **IP Subnet Mask:** The default is 255.0.0.0. User can change it to other such as 255.255.255.0. Type the subnet mask assigned to you by your ISP (if given).

● **Dynamic Route:** Select the RIP version from RIP-1, RIP-2B and RIP-2M.

● **RIP Direction:** Select the RIP direction from None, Both, In Only and Out Only.

● **Multicast:** IGMP (Internet Group Multicast Protocol) is a network-layer protocol used to establish membership in a Multicast group - it is not used to carry user data. The BiPAC 5200 Series supports both IGMP version 1 (IGMP-v1) and IGMP-v2. Select None to disable it

■ DHCP

DHCP (Dynamic Host Configuration Protocol, RFC 2131 and RFC 2132) allows individual clients to obtain TCP/IP configuration at start-up from a server.

● DHCP:

If set to **Enable**, your BiPAC 5200 Series can assign IP addresses, an IP default gateway and DNS servers to Windows 95, Windows NT and other systems that support the DHCP client.

If set to **disabled**, the DHCP server will be disabled.

If set to **Relay**, the BiPAC 5200 Series acts as a surrogate DHCP server and relays DHCP requests and responses between the remote server and the clients. Enter the IP address of the actual, remote DHCP server in the Remote DHCP Server field in this case.

When DHCP is used, the following items need to be set.

● **Starting IP Address:** This field specifies the first of the contiguous addresses in the IP address pool.

● **IP Pool Count:** This field specifies the size or count of the IP address pool.

● **Lease Time:** The current lease time of client.

● **Primary DNS Server:** Enter the IP addresses of the DNS servers. The DNS servers are passed to the DHCP clients along with the IP address and the subnet mask.

● **Secondary DNS Server:** Enter the IP addresses of the DNS servers. The DNS servers are passed to the DHCP clients along with the IP address and the subnet mask.

4.3 Advanced Setup

4.3.1 Firewall

Your router includes a firewall for controlling Internet access from your LAN and helping to prevent attacks from hackers. In addition to this, when using NAT (Network Address Translation) the router acts as a “natural” Internet firewall, since all PCs on your LAN use private IP addresses that cannot be directly accessed from the Internet.

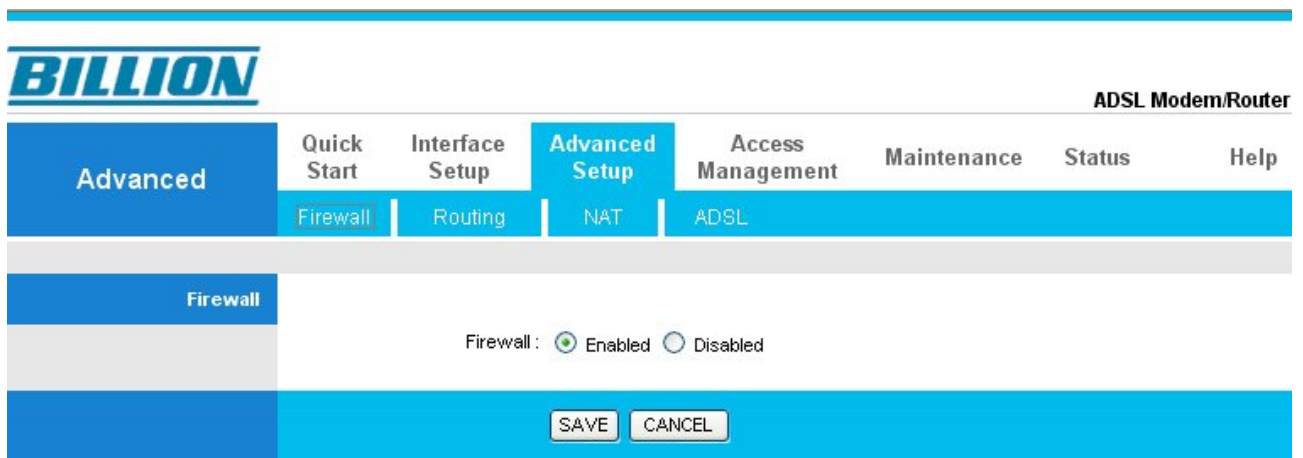

● **Firewall:⓪ Enabled:** As set in default setting, it activates your firewall function.

⓪ **Disabled:**, it disables the firewall function.

4.3.2 Routing

If you have another router with a LAN-to-LAN connection, you may create a static routing on the router that is the gateway to Internet.

The screenshot shows the configuration interface for a BILLION ADSL Modem/Router. The 'Advanced Setup' menu is selected, and the 'Routing' sub-menu is active. Below the navigation tabs, there is a 'Routing Table List' section containing a table with the following data:

#	Dest IP	Mask	Gateway IP	Metric	Device	Use	Edit	Drop
1	192.168.1.0	24	192.168.1.254	1	enet0	262		
2	default	0	Node1	2	Idle	9		

Below the table is an 'ADD ROUTE' button.

- #: Item number
- **Dest IP:** IP address of the destination network
- **Mask:** The destination mask address.
- **Gateway IP:** IP address of the gateway or existing interface that this route uses.
- **Metric:** It represents the cost of transmission for routing purposes. The number need not be precise, but it must be between 1 and 15.
- **Device:** Media/channel selected to append the route.
- **Use:** Counter for access times.
- **Edit:** Edit the route; this icon is not shown for system default route.
- **Drop:** Drop the route; this icon is not shown for system default route.

ADD Route

The screenshot shows the configuration interface for a BILLION ADSL Modem/Router. The top navigation bar includes 'Advanced', 'Quick Start', 'Interface Setup', 'Advanced Setup', 'Access Management', 'Maintenance', 'Status', and 'Help'. Under 'Advanced Setup', there are sub-tabs for 'Routing', 'NAT', and 'ADSL'. The 'Static Route' section contains the following fields:

- Destination IP Address : 0.0.0.0
- IP Subnet Mask : 0.0.0.0
- Gateway IP Address : 0.0.0.0 pvc-1
- Metric : 0
- Announced in RIP : No

At the bottom, there are four buttons: 'APPLY', 'DELETE', 'BACK', and 'RESET'.

● **Destination IP Address** : This is the destination subnet IP address.

● **IP Subnet Mask** : It is the destination IP addresses based on above destination subnet IP

● **Gateway IP Address** : This is the gateway IP address to which packets are to be forwarded.

● **Metric** : It represents the cost of transmission for routing purposes. The number need not be precise, but it must be between 1 and 15.

● **Announced in RIP**: This parameter determines if the Prestige will include the route to the remote node in its RIP broadcasts. Set "Yes", it is kept private and is not included in RIP broadcasts. Set "No", the remote node will be propagated to other hosts through RIP broadcasts.

4.3.3 NAT

The NAT (Network Address Translation - NAT, RFC 1631) is the translation of the IP address of a host in a packet. The default setting is **Dynamic NAPT**. It provides dynamic Network Address Translation capability between LAN and multiple WAN connections, and the LAN traffic is routed to appropriate WAN connections based on the destination IP addresses and Route Table. This eliminates the need for the static NAT session configuration between multiple LAN clients and multiple WAN connections.

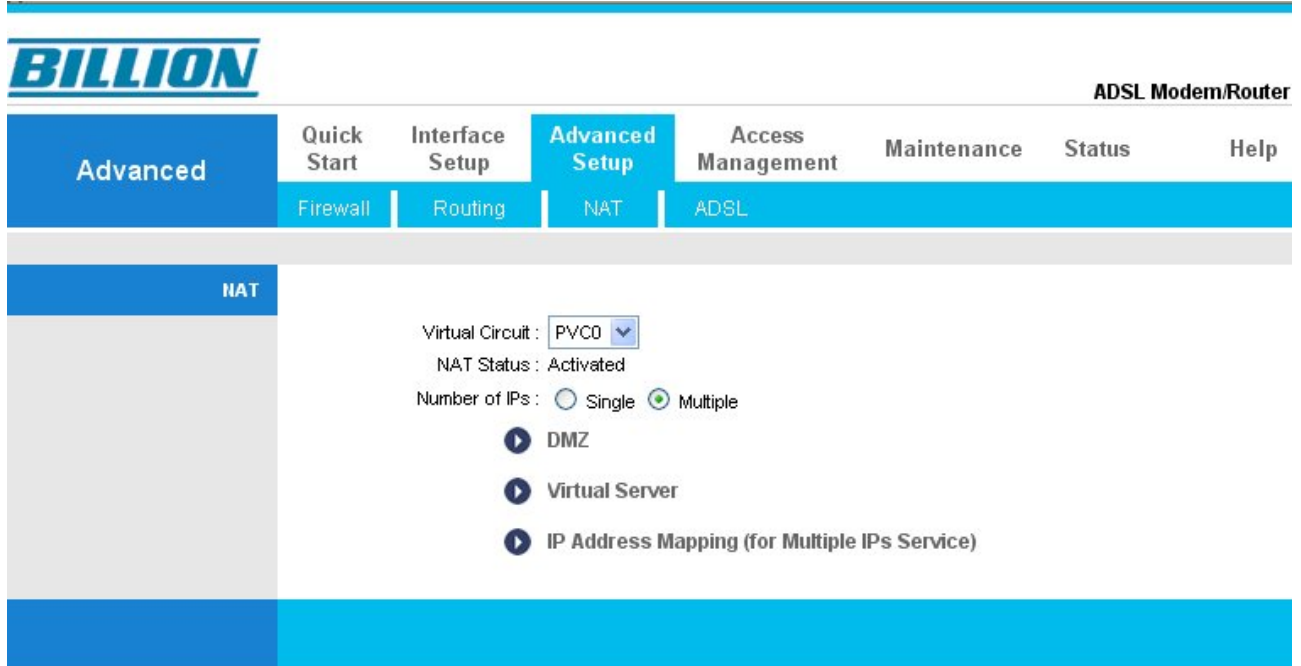

● **Virtual Circuit:** VPI (Virtual Path Identifier) and VCI (Virtual Channel Identifier) define a virtual circuit. There are eight groups of PVC can be defined and used.

● **Number of IPs:** User can select Single or Multiple.

■ DMZ

The DMZ Host is a local computer exposed to the Internet. When setting a particular internal IP address as the DMZ Host, all incoming packets will be checked by the Firewall and NAT algorithms then passed to the DMZ host, when a packet received does not use a port number used by any other Virtual Server entries.

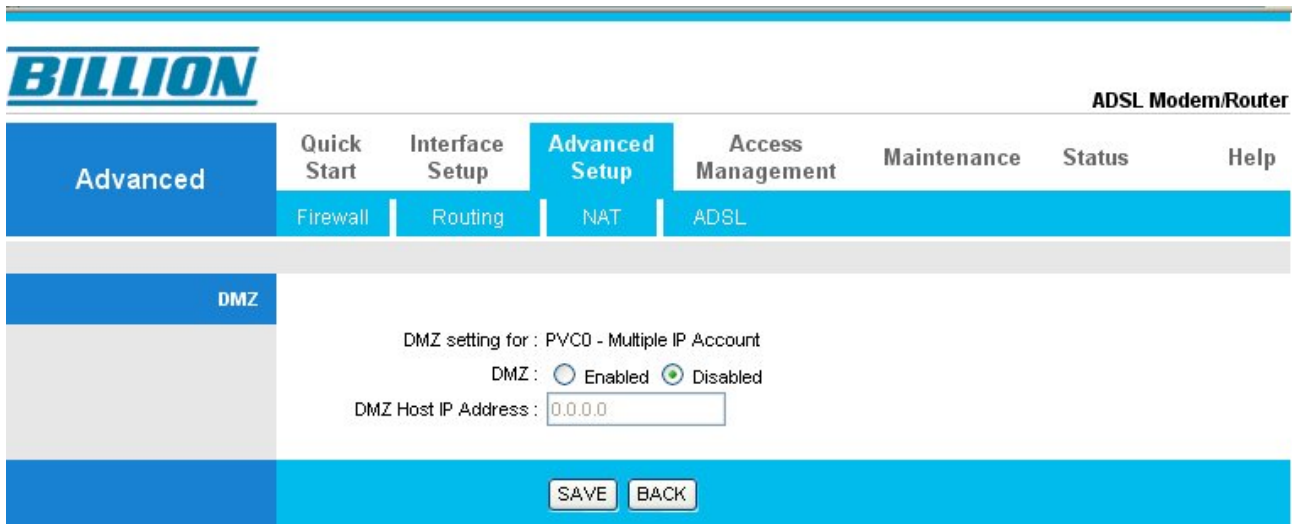

● **DMZ: Disabled:** As set in default setting, it disables the DMZ function.

● **DMZ: Enabled:** It activates your DMZ function.

● **DMZ Host Address:** Give a static IP address to the DMZ Host when **Enabled** radio button is checked. Be aware that this IP will be exposed to the WAN/Internet. Select the **Apply** button to apply your changes.

■ Virtual Server

In TCP/IP and UDP networks a port is a 16-bit number used to identify which application program (usually a server) incoming connections should be delivered to. Some ports have numbers that are pre-assigned to them by the IANA (the Internet Assigned Numbers Authority), and these are referred to as “well-known ports”. Servers follow the well-known port assignments so clients can locate them.

If you wish to run a server on your network that can be accessed from the WAN (i.e. from other machines on the Internet that are outside your local network), or any application that can accept incoming connections (e.g. Peer-to-peer/P2P software such as instant messaging applications and P2P file-sharing applications) and are using NAT (Network Address Translation), then you will usually need to configure your router to forward these incoming connection attempts using specific ports to the PC on your network running the application. You will also need to use port forwarding if you want to host an online game server.

The reason for this is that when using NAT, your publicly accessible IP address will be used by and point to your router, which then needs to deliver all traffic to the private IP addresses used by your PCs. Please see the **WAN** configuration section of this manual for more information on NAT.

The device can be configured as a virtual server so that remote users accessing services such as Web or FTP services via the public (WAN) IP address can be automatically redirected to local servers in the LAN network. Depending on the requested service (TCP/UDP port number), the device redirects the external service request to the appropriate server within the LAN network.

BILLION ADSL Modem/Router

Advanced Quick Start Interface Setup **Advanced Setup** Access Management Maintenance Status Help

Firewall Routing NAT ADSL

Virtual Server

Virtual Server for : PVC0 - Multiple IP Account

Rule Index : 1

Start Port Number : 0

End Port Number : 0

Local IP Address : 0.0.0.0

Virtual Server Listing

Rule	Start Port	End Port	Local IP Address
1	0	0	0.0.0.0
2	0	0	0.0.0.0
3	0	0	0.0.0.0
4	0	0	0.0.0.0
5	0	0	0.0.0.0
6	0	0	0.0.0.0
7	0	0	0.0.0.0
8	0	0	0.0.0.0
9	0	0	0.0.0.0
10	0	0	0.0.0.0
11	0	0	0.0.0.0
12	0	0	0.0.0.0
13	0	0	0.0.0.0
14	0	0	0.0.0.0
15	0	0	0.0.0.0
16	0	0	0.0.0.0

SAVE DELETE BACK CANCEL

- **Rule Index:** Choose the rule number.
- **Start Port Number:** Enter a port number in this field.
- **End Port Number:** Enter a port number in this field.
- **Local IP Address:** Enter your server IP address in this field.

■ IP Address Mapping

Advanced
Quick Start
Interface Setup
Advanced Setup
Access Management
Maintenance
Status
Help

Firewall
Routing
NAT
ADSL

IP Address Mapping

Address Mapping List

Address Mapping Rule : PVC0

Rule Index :

Rule Type :

Local Start IP : (for all local IPs, enter 0.0.0.0 for Start IP)

Local End IP : (for all local IPs, enter 255.255.255.255 for End IP)

Public Start IP : (0.0.0.0 for Dynamic IP)

Public End IP :

Rule	Type	Local Start IP	Local End IP	Public Start IP	Public End IP
1	-	0.0.0.0	...	0.0.0.0	...
2	-	0.0.0.0	...	0.0.0.0	...
3	-	0.0.0.0	...	0.0.0.0	...
4	-	0.0.0.0	...	0.0.0.0	...
5	-	0.0.0.0	...	0.0.0.0	...
6	-	0.0.0.0	...	0.0.0.0	...
7	-	0.0.0.0	...	0.0.0.0	...
8	-	0.0.0.0	...	0.0.0.0	...

● **Rule Index:** Choose the rule number.

● **Rule Type:**

One-to-one: This is the mode maps one local IP address to one global IP address. Note that port numbers do not change for the One-to-one NAT mapping type.

Many-to-One: This is the mode maps multiple local IP addresses to one global IP address. This is equivalent to Many to One (i.e., PAT, port address translation).

Many-to-Many Overload: This is mode maps multiple local IP addresses to shared global IP addresses.

Many-to-Many No Overload: This is the mode maps each local IP address to unique global IP addresses.

Server: This type allows you to specify inside servers of different services behind the NAT to be accessible to the outside world.

● **Local Start IP:** This is the starting Inside Local IP Address (ILA). Local IP addresses are N/A for Server port mapping.

● **Local End IP:** This is the end Inside Local IP Address (ILA). If your rule is for all local IP addresses, then enter 0.0.0.0 as the Local Start IP address and 255.255.255.255 as the Local End IP address. This field is N/A for One-to-one and Server mapping types.

● **Public Start IP:** This is the starting Inside Public IP Address. Enter 0.0.0.0 here if you have a dynamic IP address from your ISP.

● **Public End IP:** This is the ending Inside Public IP Address. This field is N/A for One-to-one, Many-to-One and Server mapping types.



Using port forwarding does have security implications, as outside users will be able to connect to PCs on your network. For this reason you are advised to use specific Virtual Server entries just for the ports your application requires, instead of using DMZ. As doing so will result in all connections from the WAN attempt to access to your public IP of the DMZ PC specified.



Attention

If you have disabled the NAT option in the WAN-ISP section, the Virtual Server function will hence be invalid.

If the DHCP server option is enabled, you have to be very careful in assigning the IP addresses of the virtual servers in order to avoid conflicts. The easiest way of configuring Virtual Servers is to manually assign static IP address to each virtual server PC, with an address that does not fall into the range of IP addresses that are to be issued by the DHCP server. You can configure the virtual server IP address manually, but it must still be in the same subnet as the router.

4.3.4 ADSL

BILLION ADSL Modem/Router

Advanced Quick Start Interface Setup **Advanced Setup** Access Management Maintenance Status Help

Firewall Routing NAT **ADSL**

ADSL

ADSL Mode : Auto Sync-Up ▼
ADSL Type : ANNEX A ▼

SAVE

● **ADSL Mode:** The default setting is **Auto Sync-UP**. This mode will automatically detect your ADSL, ADSL2+, ADSL2, G.dmt, G.lite, and T1.413. But in some area, multimode cannot detect the ADSL line code well. If it is the case, please adjust the ADSL line code to G.dmt or T1.413 first. If it still fails, please try the other values such as ALCTL, ADI, etc.

● **ADSL Type:** There are five modes “Open Annex Type and Follow DSLAM’s Setting”, “Annex A”, “Annex I”, “Annex A/L”, “Annex M” and “Annex A/I/L/M” that user can select for this connection.

4.4 Access Management

4.4.1 ACL

Access Control Listing allows you to determine which services/protocols can access which BiPAC 5200 Series interface from which computers.

You can configure the router for remote Telnet access or upload and download router firmware and configuration files using FTP. To use this feature, your computer must have an FTP client. And can use the BiPAC 5200 Series's embedded web configurator for configuration and file management.

BILLION ADSL Modem/Router

Access Management | Quick Start | Interface Setup | Advanced Setup | **Access Management** | Maintenance | Status | Help

ACL | IP Filter | SNMP | **UPnP** | DDNS

Access Control Setup

ACL : Activated Deactivated

ACL Rule Index : 1

Active : Yes No

Secure IP Address : (0.0.0.0 means all IPs)

Application : Web

Interface : WAN

Index	Active	Secure IP Address	Application	Interface
1	Yes	0.0.0.0	ALL	LAN

APPLY DELETED CANCEL

● **ACL Rule Index:** This is item number

● **Secure IP Address:** The default 0.0.0.0 allows any client to use this service to remotely manage the BiPAC 5200 Series. Type an IP address to restrict access to a client with a matching IP address.

● **Application:** Choose a service that you may use to remotely manage the BiPAC 5200 Series.

● **Interface:** Select the access interface. Choices are **LAN**, **WAN** and **Both**.

4.4.2 IP Filter

You may use telnet or Web to remotely manage the ADSL Router. User just needs to enable Telnet or Web and give it an IP address that want to access the ADSL Router. The default IP 0.0.0.0 allows any client to use this service to remotely manage the ADSL Router.

BILLION ADSL Modem/Router

Access Management | Quick Start | Interface Setup | Advanced Setup | **Access Management** | Maintenance | Status | Help

ACL | **IP Filter** | SNMP | UPnP | DDNS

IP Filter

IP Filter Set Editing

IP Filter Set Index: 1
 Interface: PVC1
 Direction: Both

IP Filter Rule Editing

IP Filter Rule Index: 1
 Active: Yes No

Source IP Address:
 Subnet Mask:
 Port Number: 0 (0 means Don't care)

Destination IP Address:
 Subnet Mask:
 Port Number: 0 (0 means Don't care)

Protocol: TCP
 Rule Unmatched: Forward

IP Filter Listing

IP Filter Set Index		Interface		Direction		N/A	
#	Active	Src IP/Mask	Dest IP/Mask	Src Port	Dest Port	Protocol	N/A
1	-	-	-	-	-	-	-
2	-	-	-	-	-	-	-
3	-	-	-	-	-	-	-
4	-	-	-	-	-	-	-
5	-	-	-	-	-	-	-
6	-	-	-	-	-	-	-

■ IP Filter Set Editing

- **IP filter Set Index:** This is item number
- **Interface:** Select which channel (PVC) to configure.
- **Direction:** Select the access to the Internet (“**Outgoing**”) or from the Internet (“**Incoming**”).or **Both**.

■ IP Filter Rule Editing

- **IP Filter Rule Index:** This is item number
- **Active:** Select **Yes** from the drop down list box to enable IP filter rule.
- **Source IP Address:** The source IP address or range of packets to be monitored.
- **Subnet Mask:** It is the destination IP addresses based on above destination subnet IP
- **Source Port Number:** This Port or Port Ranges defines the port allowed to be used by the Remote/WAN to connect to the application. Default is set from range **0 ~ 65535**. It is recommended that this option be configured by an advanced user.
- **Destination IP Address:** This is the destination subnet IP address.
- **Subnet Mask:** It is the destination IP addresses based on above destination subnet IP
- **Destination Port Number:** This is the Port or Port Ranges that defines the application.
- **Protocol:** It is the packet protocol type used by the application, select either **TCP** or **UDP** or **ICMP**
- **Rule Unmatched:** Select action for the traffic unmatching current rule; Forward to leave it pass through, and NEXT to check it by the next rule.

■ IP Filter Listing

- #: Item number.
- **Active:** Whether the connection is currently active.
- **Src IP Mask:** The source IP address or range of packets to be monitored.
- **Dest IP Mask:** This is the destination subnet IP address.
- **Src port:** This Port or Port Ranges defines the port allowed to be used by the Remote/WAN to connect to the application. Default is set from range **0 ~ 65535**. It is recommended that this option be configured by an advanced user.
- **Dest Port:** This is the Port or Port Ranges that defines the application.
- **Protocol:** It is the packet protocol type used by the application, select either **TCP** or **UDP** or **ICMP**

4.4.3 SNMP

Simple Network Management Protocol (SNMP) is a protocol used for exchanging management information between network devices. SNMP is a member of the TCP/IP protocol suite. BiPAC 5200 series supports SNMP agent functionality which allows a manager station to manage and monitor the router through the network.

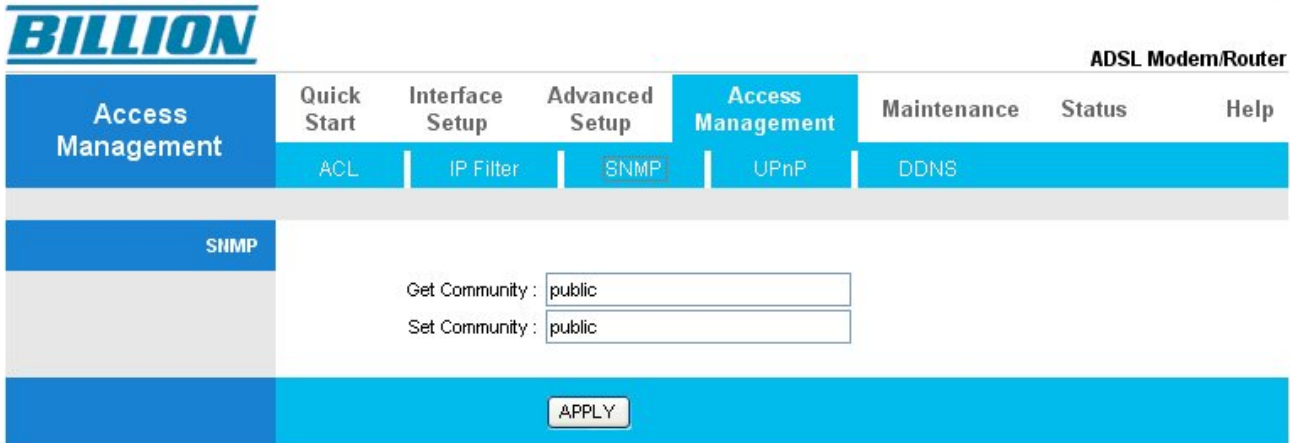

● **Get Community:** Type the Get Community, which is the password for the incoming Get-and GetNext requests from the management station.

● **Set Community:** Type the Set Community, which is the password for incoming Set requests from the management station.

4.4.4 UPnP

UPnP offers peer-to-peer network connectivity for PCs and other network devices, along with control and data transfer between devices. UPnP offers many advantages for users running NAT routers through UPnP NAT Traversal, and on supported systems makes tasks such as port forwarding much easier by letting the application control the required settings, removing the need for the user to control advanced configuration of their device.

Both the user's Operating System and the relevant application must support UPnP in addition to the router. Windows XP and Windows Me natively support UPnP (when the component is installed), and Windows 98 users may install the Internet Connection Sharing client from Windows XP in order to support UPnP. Windows 2000 does not support UPnP.

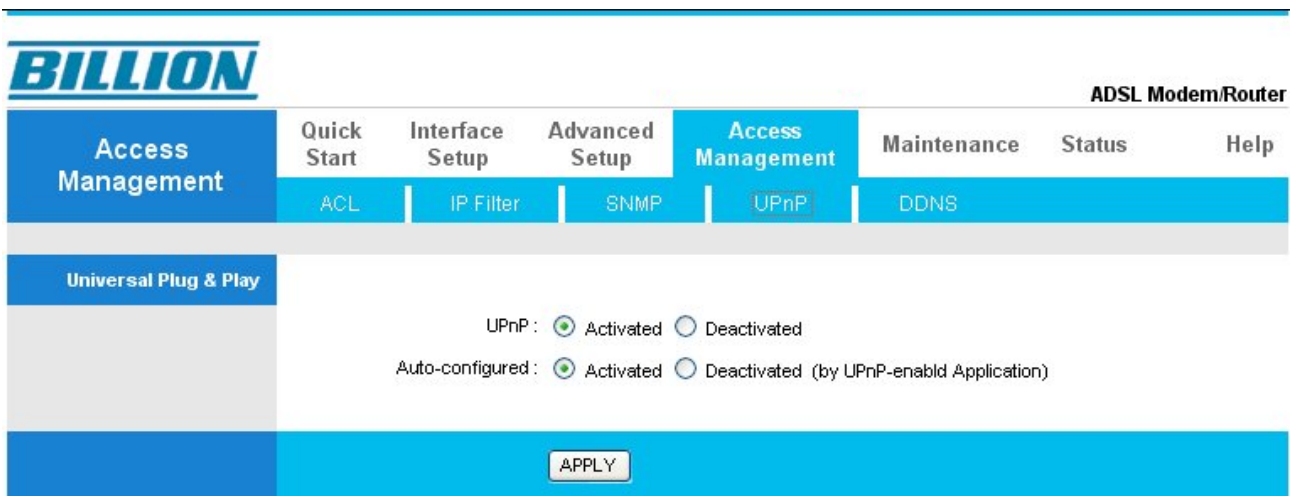

● **UPnP:** Select this checkbox to activate UPnP. Be aware that anyone could use a UPnP application to open the web configurator's login screen without entering the BiPAC 5200 Series 's IP address

● **Auto-configured:** Select this check box to allow UPnP-enabled applications to automatically configure the BiPAC 5200 Series so that they can communicate through the BiPAC 5200 Series, for example by using NAT traversal, UPnP applications automatically reserve a NAT forwarding port in order to communicate with another UPnP enabled device; this eliminates the need to manually configure port forwarding for the UPnP enabled application.

4.4.5 DDNS

The Dynamic DNS function allows you to alias a dynamic IP address to a static hostname, allowing users whose ISP does not assign them a static IP address to use a domain name. This is especially useful for hosting servers via your ADSL connection, so that anyone wishing to connect to you may use your domain name, rather than having to use your dynamic IP address, which changes from time to time. This dynamic IP address is the WAN IP address of the router, which is assigned to you by your ISP.

You will first need to register and establish an account with the Dynamic DNS provider using their website, for example <http://www.dyndns.org/>

The screenshot shows the configuration page for Dynamic DNS on a BILLION ADSL Modem/Router. The page has a blue header with the BILLION logo and a navigation menu with tabs: Access Management, Quick Start, Interface Setup, Advanced Setup, Access Management, Maintenance, Status, and Help. Under the Access Management tab, there are sub-tabs: ACL, IP Filter, SNMP, UPnP, and DDNS. The DDNS sub-tab is selected, showing the Dynamic DNS configuration form. The form includes a 'Dynamic DNS' section with a radio button for 'Activated' (unselected) and 'Deactivated' (selected). Below this are fields for 'Service Provider' (www.dyndns.org), 'My Host Name', 'E-mail Address', 'Username', and 'Password'. At the bottom, there is a 'Wildcard support' section with radio buttons for 'Yes' (unselected) and 'No' (selected). An 'APPLY' button is located at the bottom right of the form.

- **Dynamic DNS:** Select this check box to use dynamic DNS.
- **Service Provider:** Select the name of your Dynamic DNS service provider.
- **My Host Name:** Type the domain name assigned to your BiPAC 5200 Series by your Dynamic DNS provider.
- **E-mail Address:** Type your e-mail address.
- **Username:** Type your user name.
- **Password:** Type the password assigned to you.
- **Wildcard support:** Select this check box to enable DYNDNS Wildcard.

4.5 Maintenance

4.5.1 Administrator

In factory setting, the default password is **admin**, and that for user is also password. You can change the default password to ensure that someone cannot adjust your settings without your permission. Every time you change your password, please record the password and keep it at a safe place.

The screenshot shows the BILLION ADSL Modem/Router web interface. The top navigation bar includes the BILLION logo and the text "ADSL Modem/Router". Below the logo is a menu with "Maintenance" selected. The "Maintenance" menu is expanded to show sub-items: Administration, Time Zone, Firmware, SysRestart, and Diagnostics. The "Administrator" section is active, displaying the following fields:

- Username : **admin**
- New Password :
- Confirm Password :

At the bottom of the form are two buttons: "APPLY" and "CANCEL".

- **New Password:** Type the new password in this field
- **Confirm Password:** Type the new password again in this field.

4.5.2 Time Zone

The router does not have a real time clock on board; instead, it uses the Simple Network Time Protocol (SNTP) to get the current time from an SNTP server outside your network. Choose your local time zone. After a successful connection to the Internet, the router will retrieve the correct local time from the SNTP server you have specified. If you prefer to specify an SNTP server other than those in the drop-down list, simply enter its IP address as shown above. Your ISP may provide an SNTP server for you to use.

The screenshot shows the BILLION ADSL Modem/Router web interface. The top navigation bar includes 'Maintenance', 'Quick Start', 'Interface Setup', 'Advanced Setup', 'Access Management', 'Maintenance', 'Status', and 'Help'. The 'Maintenance' menu is expanded to show 'Administration', 'Time Zone', 'Firmware', 'SysRestart', and 'Diagnostics'. The 'Time Zone' page displays the current date/time as 01/01/2000 00:16:21. Under 'Time Synchronization', there are three radio button options: 'NTP Server automatically' (selected), 'PC's Clock', and 'Manually'. Below these is a 'Time Zone' dropdown menu set to '(GMT-02:00) Mid-Atlantic'. There are also radio buttons for 'Daylight Saving' set to 'Disabled'. At the bottom, the 'NTP Server Address' is set to '0.0.0.0' with a note '(0.0.0.0: Default Value)'. 'APPLY' and 'CANCEL' buttons are at the bottom right.

- **Synchronize time with:** Select the time service protocol that your time server sends when you turn on the Router.
- **Time Zone:** Choose the time zone of your location. This will set the time difference between your time zone and Greenwich Mean Time (GMT).
- **Daylight Saving:** Select this option if you use daylight savings time
- **NTP Server Address:** Enter the IP address of your time server. Check with your ISP/network administrator if you are unsure of this information.

4.5.3 Firmware

Your router's "firmware" is the software that allows it to operate and provides all its functionality. Think of your router as a dedicated computer, and the firmware as the software it runs. Over time this software may be improved and modified, and your router allows you to upgrade the software it runs to take advantage of these changes.

To upgrade the firmware of BiPAC 5200 Series, you should download or copy the firmware to your local environment first. Press the "**Browse...**" button to specify the path of the firmware file. Then, click "**Upgrade**" to start upgrading. When the procedure is completed, BiPAC 5200 Series will reset automatically to make the new firmware work.

The screenshot shows the BILLION ADSL Modem/Router web interface. The top navigation bar includes "Maintenance", "Quick Start", "Interface Setup", "Advanced Setup", "Access Management", "Maintenance", "Status", and "Help". The "Maintenance" menu is expanded to show "Administration", "Time Zone", "Firmware", "SysRestart", and "Diagnostics". The "Firmware Upgrade" section is active, displaying "Current Firmware Ver : 2.7.0.7(ZUE0.B1)3.3.2.5" and a "New Firmware Location" field with a "Browse..." button. A status message with a red warning icon states: "It might take several minutes, don't power off it during upgrading. Device will restart after the upgrade." At the bottom, there is a large blue bar with an "UPGRADE" button.

● **New Firmware Location:** Type in the location of the file you want to upload in this field or click **Browse** to find it.

● **Browse:** Click **Browse...** to find the .ras file you want to upload. Remember that you must decompress compressed (.zip) files before you can upload them.

● **UPGRADE:** Click **UPGRADE** to begin the upload process. This process may take up to two minutes.

After two minutes, log in again and check your new firmware version in the System Status screen.

If the upload was not successful, the following screen will appear. Click Back to go back to the Firmware screen.



DO NOT power down the router or interrupt the firmware upgrading while it is still in process. Improper operation could damage the router.

Warning

4.5.4 SysRestart

Click **SysRestart** with option **Current Settings** to reboot your router (and restore your last saved configuration).

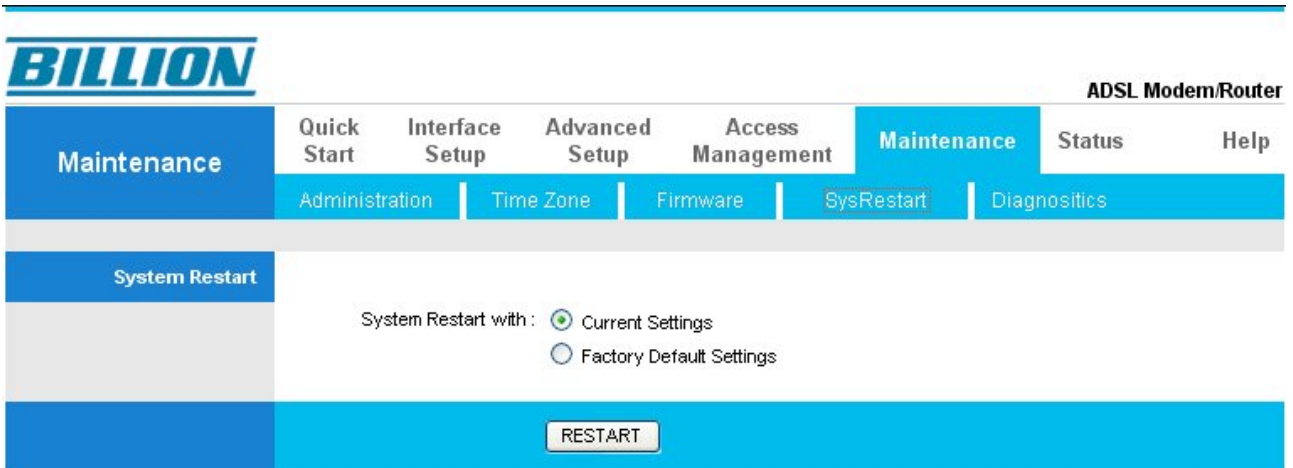

If you wish to restart the router using the factory default settings (for example, after a firmware upgrade or if you have saved an incorrect configuration), select **Factory Default Settings** to reset to factory default settings.

You may also reset your router to factory settings by holding the small Reset pinhole button on the back of your router in for 10-12 seconds whilst the router is turned on.

4.5.6 Diagnostics

The Diagnostic Test page shows the test results for the connectivity of the physical layer and protocol layer for both LAN and WAN sides

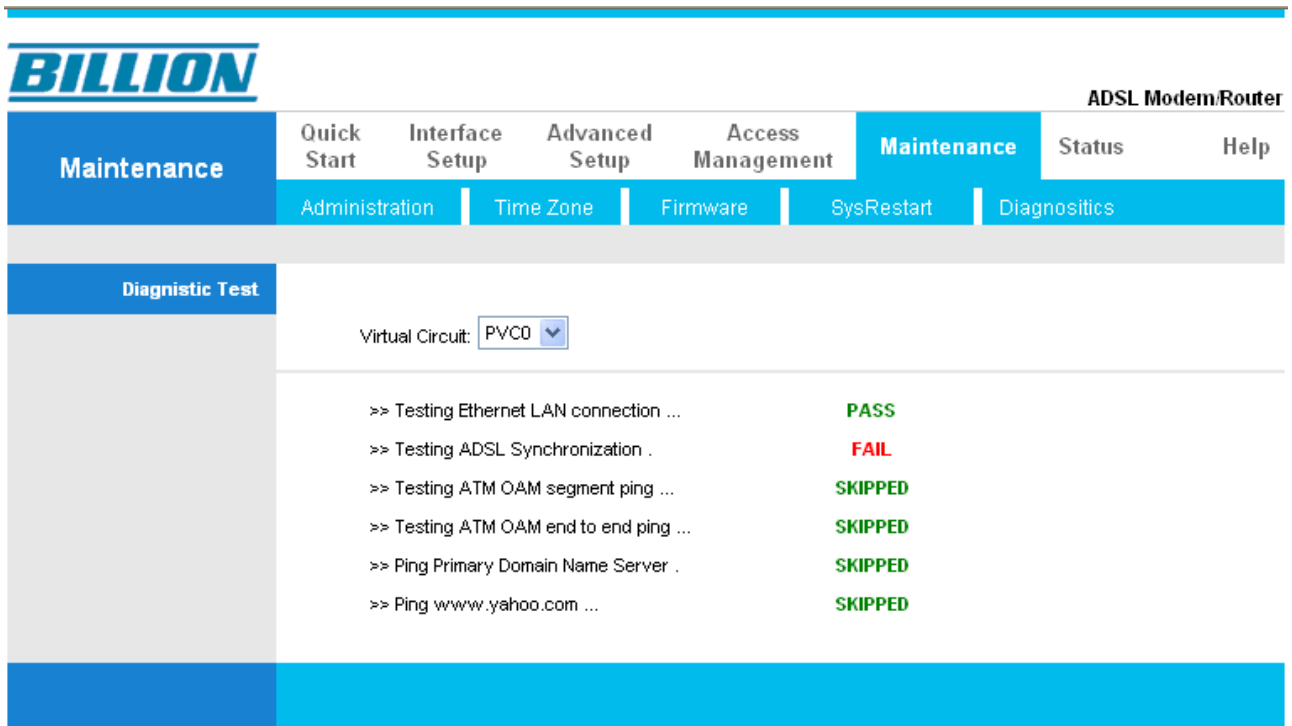

BILLION

ADSL Modem/Router

Maintenance Quick Start Interface Setup Advanced Setup Access Management Maintenance Status Help

Administration Time Zone Firmware SysRestart Diagnostics

Diagnostic Test

Virtual Circuit: PVC0

>> Testing Ethernet LAN connection ...	PASS
>> Testing ADSL Synchronization .	FAIL
>> Testing ATM OAM segment ping ...	SKIPPED
>> Testing ATM OAM end to end ping ...	SKIPPED
>> Ping Primary Domain Name Server .	SKIPPED
>> Ping www.yahoo.com ...	SKIPPED

4.6 Status

4.6.1 Device Info

ADSL Modem/Router

Status	Quick Start	Interface Setup	Advanced Setup	Access Management	Maintenance	Status	Help
	Device Info	System Log	Statistics				
Device Information	Firmware Version : 2.7.0.23(UE0.B1C)3.3.2.5 MAC Address : 00:04:ed:01:23:45						
LAN	IP Address : 192.168.1.254 Subnet Mask : 255.255.255.0 DHCP Server : Enabled						
WAN	Virtual Circuit : <input type="text" value="PVC0"/> Status : Not Connected Connection Type : PPPoE IP Address : 0.0.0.0 Subnet Mask : 0.0.0.0 Default Gateway : 0.0.0.0 DNS Server : 0.0.0.0						
ADSL	ADSL Firmware Ver : FwVer:3.3.2.5_A_TC3084 HwVer:T14.F7_0.0 Line State : Down Modulation : Multi-Mode Annex Mode : ANNEX_A						
		Downstream	Upstream				
	SNR Margin :	N/A	N/A	db			
	Line Attenuation :	N/A	N/A	db			
	Data Rate :	0	0	kbps			

■ Device Information

- **Firmware version:** This is the Firmware version
- **MAC Address:** This is the MAC Address

■ LAN

- **IP Address:** LAN port IP address.
- **Sub Net Mask:** LAN port IP subnet mask.
- **DHCP Server:** LAN port DHCP role - Enabled, Relay or disabled

■ WAN

- **Status:** “Not connected” or “Connected”
- **Virtual Circuit:** There are eight groups of PVC can be defined.
- VPI: The valid range for the VPI is 0 to 255
- VCI: The valid range for the VCI is 32 to 65535
- **Connection Type:** Name of the WAN connection.
- **VPI/VCI:** Virtual Path Identifier and Virtual Channel Identifier
- **IP Address:** WAN port IP address.
- **Subnet mask:** WAN port IP subnet mask.
- **Default Gateway:** The IP address of the default gateway.
- **DNS Server:** WAN port DHCP role - Enabled, Relay or disabled

■ ADSL

- **ADSL firmware ver:** This is the DSL firmware version associated with your router
- **Line State:** This is the status of your ADSL link.
- **Annex Mode:** To show the router’s type, e.g. Annex A, Annex B
- **Max TX Power:** This field displays the transmit output power level of the ADSL Router.

4.6.2 System Log

Display system logs accumulated up to the present time. You can trace historical information with this function.

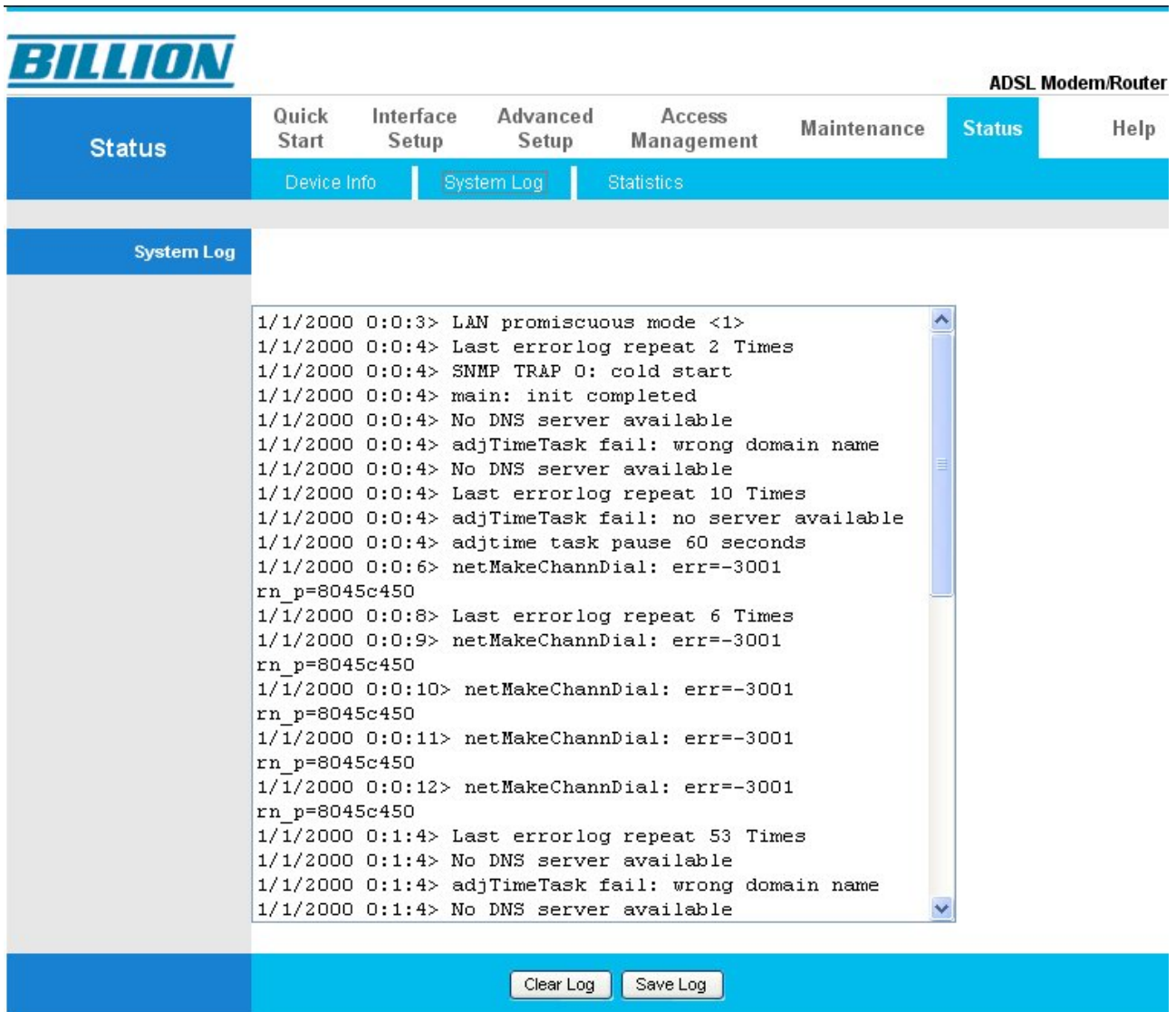

The screenshot displays the web interface of a BILLION ADSL Modem/Router. The top navigation bar includes 'Status', 'Quick Start', 'Interface Setup', 'Advanced Setup', 'Access Management', 'Maintenance', 'Status', and 'Help'. The 'Status' menu is expanded, showing 'Device Info', 'System Log', and 'Statistics'. The 'System Log' page is active, displaying a scrollable list of system events. The log entries include timestamps, error messages, and status reports. At the bottom of the page, there are two buttons: 'Clear Log' and 'Save Log'.

```
1/1/2000 0:0:3> LAN promiscuous mode <1>
1/1/2000 0:0:4> Last errorlog repeat 2 Times
1/1/2000 0:0:4> SNMP TRAP 0: cold start
1/1/2000 0:0:4> main: init completed
1/1/2000 0:0:4> No DNS server available
1/1/2000 0:0:4> adjTimeTask fail: wrong domain name
1/1/2000 0:0:4> No DNS server available
1/1/2000 0:0:4> Last errorlog repeat 10 Times
1/1/2000 0:0:4> adjTimeTask fail: no server available
1/1/2000 0:0:4> adjtime task pause 60 seconds
1/1/2000 0:0:6> netMakeChannDial: err=-3001
rn_p=8045c450
1/1/2000 0:0:8> Last errorlog repeat 6 Times
1/1/2000 0:0:9> netMakeChannDial: err=-3001
rn_p=8045c450
1/1/2000 0:0:10> netMakeChannDial: err=-3001
rn_p=8045c450
1/1/2000 0:0:11> netMakeChannDial: err=-3001
rn_p=8045c450
1/1/2000 0:0:12> netMakeChannDial: err=-3001
rn_p=8045c450
1/1/2000 0:1:4> Last errorlog repeat 53 Times
1/1/2000 0:1:4> No DNS server available
1/1/2000 0:1:4> adjTimeTask fail: wrong domain name
1/1/2000 0:1:4> No DNS server available
```

4.6.3 Statistics

Read-only information here includes port status and packet specific statistics. Also provided are "Transmit Statistics" and "Receive Statistics".

Ethernet

The screenshot shows the BILLION ADSL Modem/Router web interface. The 'Status' page is active, with sub-menus for 'Device Info', 'System Log', and 'Statistics'. The 'Traffic Statistics' section is expanded, showing the 'Interface' set to 'Ethernet'. A table displays the following statistics:

Transmit Statistics		Receive Statistics	
Transmit Frames	479	Receive Frames	486
Transmit Multicast Frames	42	Receive Multicast Frames	43
Transmit total Bytes	276658	Receive total Bytes	60264
Transmit Collision	0	Receive CRC Errors	0
Transmit Error Frames	0	Receive Under-size Frames	0

A 'REFRESH' button is located at the bottom of the statistics section.

- **Interface:** This field displays the type of port
- **Transmit Frames:** This field displays the number of frames transmitted in the last second.
- **Transmit Multicast Frames:** This field displays the number of multicast frames transmitted in the last second.
- **Transmit total Bytes:** This field displays the number of bytes transmitted in the last second.
- **Transmit Collision:** This is the number of collisions on this port.
- **Transmit Error Frames:** This field displays the number of error packets on this port.
- **Receive Frames:** This field displays the number of frames received in the last second.
- **Receive Multicast Frames:** This field displays the number of multicast frames received in the last second.
- **Receive total Bytes:** This field displays the number of bytes received in the last second.
- **Receive CRC Errors:** This field displays the number of error packets on this port.
- **Receive Under-size Frames:** This field displays the number of under-size frames received in the last second.

ADSL

The screenshot shows the web interface of a BILLION ADSL Modem/Router. The top navigation bar includes 'Quick Start', 'Interface Setup', 'Advanced Setup', 'Access Management', 'Maintenance', 'Status', and 'Help'. The 'Status' menu is expanded to show 'Device Info', 'System Log', and 'Statistics'. The 'Traffic Statistics' section is active, showing the 'Interface' set to 'ADSL'. Below this is a table with transmit and receive statistics, and a 'REFRESH' button.

Transmit Statistics		Receive Statistics	
Transmit total PDUs	0	Receive total PDUs	0
Transmit total Error Counts	0	Receive total Error Counts	0

● **Transmit total PDUs:** This field displays the number of total PDU transmitted in the last second.

● **Transmit total Error Counts:** This field displays the number of total error transmitted in the last second.

● **Receive total PDUs:** This field displays the number of total PDU received in the last second.

● **Receive total Error Counts:** This field displays the number of total error received in the last second.

Chapter 5

Troubleshooting

If the ADSL2+ Router is not functioning properly, you can refer first to this chapter for simple troubleshooting before contacting your service provider. This could save your time and effort but if the symptoms persist, then consult your service provider.

Problems starting up the router

Problem	Corrective Action
None of the LEDs are on when you turn on the router.	Check the connection between the adapter and the router. If the error persists, you may have a hardware problem. In this case you should contact technical support.
You have forgotten your router login and/or password.	Try the default login and password, please refers to Chapter 3. If this fails, you can restore your router to its factory settings by holding the Reset button on the back of your router for 6 seconds above.

Problems with the WAN Interface

Problem	Corrective Action
Initialization of the PVC connection (“linesync”) failed.	Ensure that the telephone cable is connected properly from the ADSL port to the wall jack. The ADSL LED on the front panel of the router should be on. Check that your VPI, VCI, encapsulation type and type of multiplexing settings are the same as those provided by your ISP. Reboot the router GE. If you still have problems, you may need to verify these settings with your ISP.

<p>Frequent loss of ADSL linesync (disconnections).</p>	<p>Ensure that all other devices connected to the same telephone line as your router (e.g. telephones, fax machines, analogue modems) have a line filter connected between them and the wall socket (unless you are using a Central Splitter or Central Filter installed by a qualified and licensed electrician), and ensure that all line filters are correctly installed and the right way around. Missing line filters or line filters installed the wrong way around can cause problems with your ADSL connection, including causing frequent disconnections.</p>
--	--

Problems with the LAN Interface

Problem	Corrective Action
<p>Can't ping any PCs on the LAN.</p>	<p>Check the Ethernet LEDs on the front panel. The LED should be on for a port that has a PC connected. If it is off, check the cables between your router and the PC. Make sure you have uninstalled any software firewall for troubleshooting.</p>
	<p>Verify that the IP address and the subnet mask are consistent between the router and the workstations.</p>

Product Support and Contact Information

Most problems can be solved by referring to the **Troubleshooting** section in the User's Manual. If you cannot resolve the problem with the **Troubleshooting** chapter, please contact the dealer where you purchased this product.

Contact Billion**AUSTRALIA**

<http://www.billion.com.au>

©2006 Billion Electric Co., Ltd. PC Range P/L. All Rights Reserved.

WORLDWIDE

<http://www.billion.com>