



# Manual be.IP plus - world edition

Copyright© Version 10.1.7 RC2 (SVN 5159) bintec elmeg GmbH

## Legal Notice

### Warranty

This publication is subject to change.

bintec elmeg GmbH offers no warranty whatsoever for information contained in this manual. bintec elmeg GmbH is not liable for any direct, indirect, collateral, consequential or any other damage connected to the delivery, supply or use of this manual.

Copyright © bintec elmeg GmbH.

All rights to the data included, in particular the right to copy and propagate, are reserved by bintec elmeg GmbH.

### Open source software in this product

Along with other components, this product contains open source software that has been developed by third party suppliers and which is licensed under an open source software license. These open source software files are subject to copyright. For a current list of the open source software programs and the open source software licenses, go to [www.bintec-elmeg.com](http://www.bintec-elmeg.com).

### GEMA

This product uses internal music for calls on hold for which approval from GEMA (German Society for Musical Performance and Mechanical Reproduction Rights) is not required. This has been confirmed by GEMA with the following approval certification. The approval certification can be viewed at the following web address: [www.bintec-elmeg.com](http://www.bintec-elmeg.com). System hold music: elmeg Song, Hold the line.

# Table of Contents

Chapter 1	Introduction . . . . .	1
1.1	be.IP plus - world edition. . . . .	1
1.1.1	Setting up and connecting . . . . .	1
1.1.2	Connectors . . . . .	3
1.1.3	Connections (on the side) . . . . .	3
1.1.4	Mounting brackets . . . . .	3
1.1.5	LEDs . . . . .	4
1.1.6	Scope of supply . . . . .	6
1.1.7	General Product Features . . . . .	6
1.2	Reset . . . . .	8
1.3	Presettings . . . . .	8
1.4	Support-Information. . . . .	12
Chapter 2	Mounting . . . . .	13
2.1	Connecting terminals . . . . .	13
2.1.1	Internal ISDN connection . . . . .	13
2.1.2	Termination of ISDN interfaces . . . . .	13
2.2	Reset button . . . . .	14
2.3	Wall mounting . . . . .	14
2.4	Pin Assignments . . . . .	15
2.4.1	Ethernet interfaces . . . . .	15
2.4.2	ISDN interface . . . . .	15
2.4.3	Analogue interfaces (FXS -/FXO) . . . . .	16
2.4.4	xDSL interface . . . . .	16
2.4.5	Serial interface . . . . .	17
2.4.6	USB interface . . . . .	17

Chapter 3	Basic configuration . . . . .	19
3.1	Preparations . . . . .	19
3.1.1	Systemsoftware . . . . .	19
3.1.2	System requirements . . . . .	19
3.1.3	Gathering data . . . . .	20
3.1.4	Setting up a PC . . . . .	21
3.2	Configuring the system . . . . .	22
3.2.1	Network setting (LAN) . . . . .	23
3.2.2	Enter SIP provider . . . . .	23
3.3	Setting up an internet connection . . . . .	23
3.3.1	Internet connection via the internal VDSL modem . . . . .	23
3.3.2	Other internet connections . . . . .	23
3.3.3	Testing the configuration. . . . .	24
3.4	User access . . . . .	24
3.5	Software updates for be.IP plus - world edition . . . . .	25
Chapter 4	Operation via the telephone . . . . .	27
Chapter 5	Access and configuration. . . . .	28
5.1	Access via LAN . . . . .	28
5.1.1	HTTP/HTTPS . . . . .	28
5.2	Configuration. . . . .	28
5.2.1	Configuration interface . . . . .	28
Chapter 6	Assistants . . . . .	36
Chapter 7	System Management. . . . .	37
7.1	Status. . . . .	37

7.2	Global Settings . . . . .	39
7.2.1	System . . . . .	39
7.2.2	Passwords . . . . .	45
7.2.3	Date and Time . . . . .	48
7.2.4	Timer . . . . .	51
7.2.5	System Licences . . . . .	54
7.3	Access Codes . . . . .	56
7.3.1	Alternative Access Codes . . . . .	56
7.4	Interface Mode / Bridge Groups . . . . .	57
7.4.1	Interfaces . . . . .	59
7.5	Administrative Access . . . . .	62
7.5.1	Access . . . . .	62
7.5.2	SSH . . . . .	63
7.5.3	SNMP . . . . .	66
7.6	Remote Authentication . . . . .	67
7.6.1	RADIUS . . . . .	68
7.6.2	Options . . . . .	73
7.7	Configuration Access . . . . .	73
7.7.1	Access Profiles . . . . .	74
7.7.2	Users . . . . .	76
7.8	Certificates . . . . .	77
7.8.1	Certificate List . . . . .	78
7.8.2	CRLs . . . . .	85
7.8.3	Certificate Servers . . . . .	86
<b>Chapter 8</b>	<b>Physical Interfaces . . . . .</b>	<b>87</b>
8.1	Ethernet Ports . . . . .	87
8.1.1	Port Configuration . . . . .	88
8.2	ISDN Ports . . . . .	89

8.2.1	ISDN External . . . . .	90
8.2.2	ISDN Internal . . . . .	92
8.2.3	ISDN Configuration . . . . .	93
8.3	Analogue Ports . . . . .	93
8.3.1	Analogue External (FXO) . . . . .	94
8.3.2	Analogue Internal (FXS) . . . . .	96
8.4	DSL Modem . . . . .	97
8.4.1	DSL Configuration . . . . .	97
8.5	UMTS/LTE. . . . .	100
8.5.1	UMTS/LTE. . . . .	100
<b>Chapter 9</b>	<b>VoIP . . . . .</b>	<b>109</b>
9.1	Settings . . . . .	109
9.1.1	SIP Provider . . . . .	109
9.1.2	Locations . . . . .	118
9.1.3	Codec Profiles . . . . .	121
9.1.4	Options . . . . .	123
<b>Chapter 10</b>	<b>Numbering . . . . .</b>	<b>126</b>
10.1	Trunk Settings . . . . .	126
10.1.1	Trunks . . . . .	126
10.1.2	Trunk Numbers . . . . .	129
10.1.3	Trunk Groups . . . . .	131
10.1.4	X.31 . . . . .	132
10.2	User Settings . . . . .	133
10.2.1	Users . . . . .	133
10.2.2	Class of Services . . . . .	141
10.2.3	Parallel Ringing . . . . .	155
10.3	Groups & Teams . . . . .	156
10.3.1	Teams . . . . .	156

10.4	Call Distribution . . . . .	163
10.4.1	Incoming Distribution . . . . .	163
10.4.2	Misdial Routing . . . . .	166
<b>Chapter 11</b>	<b>Terminals . . . . .</b>	<b>167</b>
11.1	elmeg System Phones . . . . .	167
11.1.1	System Phone . . . . .	167
11.1.2	elmeg IP . . . . .	187
11.1.3	elmeg DECT . . . . .	196
11.2	Other phones . . . . .	200
11.2.1	VoIP . . . . .	201
11.2.2	VoIP - Configuration example (a smartphone as an internal VoIP telephone)	204
11.2.3	ISDN . . . . .	223
11.2.4	analog . . . . .	224
11.2.5	CAPI . . . . .	228
11.3	Overview . . . . .	228
11.3.1	Overview . . . . .	228
<b>Chapter 12</b>	<b>Call Routing . . . . .</b>	<b>230</b>
12.1	Outgoing Services . . . . .	230
12.1.1	Direct Call . . . . .	230
12.1.2	Call Forwarding . . . . .	231
12.1.3	Dial Control . . . . .	233
12.1.4	Priority Numbers . . . . .	234
12.2	Automatic Route Selection . . . . .	235
12.2.1	General . . . . .	235
12.2.2	Interfaces / Provider . . . . .	236
12.2.3	Zones & Routing . . . . .	237
<b>Chapter 13</b>	<b>Applications . . . . .</b>	<b>239</b>

13.1	Calendar . . . . .	239
13.1.1	Calendar . . . . .	239
13.1.2	Public Holiday . . . . .	242
13.2	Rerouting . . . . .	243
13.2.1	Rerouting Functions . . . . .	243
13.2.2	Rerouting Applications . . . . .	247
13.3	Voice Applications . . . . .	248
13.3.1	Wave Files . . . . .	249
13.4	System Phonebook . . . . .	250
13.4.1	Entries . . . . .	251
13.4.2	Import / Export . . . . .	252
13.4.3	General . . . . .	254
13.5	Call Data Records . . . . .	254
13.5.1	Outgoing . . . . .	255
13.5.2	Incoming . . . . .	255
13.5.3	General . . . . .	256
13.6	Call List . . . . .	258
13.6.1	Incoming . . . . .	258
13.6.2	Outgoing . . . . .	258
13.6.3	General . . . . .	259
13.7	Mini Call Center . . . . .	260
13.7.1	Status . . . . .	260
13.7.2	Lines . . . . .	261
13.7.3	Agents . . . . .	264
13.7.4	General . . . . .	265
13.8	Doorcom Units . . . . .	265
13.8.1	Doorcom Units . . . . .	266
13.8.2	Doorcom Signalling . . . . .	267
13.9	Voice Mail System . . . . .	269
13.9.1	Voice Mail Boxes . . . . .	270



13.9.2	Status . . . . .	274
13.9.3	General . . . . .	275
<b>Chapter 14</b>	<b>LAN . . . . .</b>	<b>277</b>
14.1	IP Configuration . . . . .	277
14.1.1	Interfaces . . . . .	277
14.2	VLAN . . . . .	289
14.2.1	VLANs . . . . .	289
14.2.2	Port Configuration . . . . .	290
14.2.3	Administration . . . . .	291
<b>Chapter 15</b>	<b>Wireless LAN Controller . . . . .</b>	<b>292</b>
15.1	Wizard . . . . .	292
15.1.1	Basic Settings . . . . .	293
15.1.2	Radio Profile . . . . .	294
15.1.3	Wireless Network . . . . .	294
15.1.4	Start automatic installation . . . . .	296
15.2	Controller Configuration . . . . .	298
15.2.1	General . . . . .	298
15.2.2	Slave AP Autoprofile . . . . .	300
15.3	Slave AP configuration . . . . .	301
15.3.1	Slave Access Points . . . . .	301
15.3.2	Radio Profiles . . . . .	304
15.3.3	Wireless Networks (VSS) . . . . .	310
15.4	Monitoring . . . . .	317
15.4.1	WLAN Controller . . . . .	317
15.4.2	Slave Access Points . . . . .	318
15.4.3	Active Clients . . . . .	319
15.4.4	Wireless Networks (VSS) . . . . .	320
15.4.5	Client Management . . . . .	320

15.5	Neighbor Monitoring . . . . .	320
15.5.1	Neighbor APs . . . . .	320
15.5.2	Rogue APs . . . . .	321
15.5.3	Rogue Clients . . . . .	321
15.6	Maintenance . . . . .	322
15.6.1	Firmware Maintenance . . . . .	322
<b>Chapter 16</b>	<b>Networking . . . . .</b>	<b>325</b>
16.1	Routes . . . . .	325
16.1.1	IPv4 Route Configuration . . . . .	325
16.1.2	IPv6 Route Configuration . . . . .	330
16.1.3	IPv4 Routing Table . . . . .	332
16.1.4	IPv6 Routing Table . . . . .	333
16.1.5	Options . . . . .	334
16.2	IPv6 General Prefixes . . . . .	335
16.2.1	General Prefix Configuration . . . . .	335
16.3	NAT . . . . .	336
16.3.1	NAT Interfaces . . . . .	337
16.3.2	NAT Configuration . . . . .	338
16.3.3	NAT - Configuration example . . . . .	344
16.4	Load Balancing . . . . .	346
16.4.1	Load Balancing Groups . . . . .	346
16.4.2	Special Session Handling . . . . .	350
16.4.3	Load balancing - Configuration example . . . . .	353
16.5	QoS . . . . .	356
16.5.1	IPv4/IPv6 Filter . . . . .	356
16.5.2	QoS Classification . . . . .	360
16.5.3	QoS Interfaces/Policies . . . . .	362
16.6	Access Rules . . . . .	369
16.6.1	Access Filter . . . . .	370

16.6.2	Rule Chains . . . . .	374
16.6.3	Interface Assignment . . . . .	375
<b>Chapter 17</b>	<b>Multicast. . . . .</b>	<b>377</b>
17.1	General . . . . .	378
17.1.1	General . . . . .	379
17.2	IGMP . . . . .	379
17.2.1	IGMP . . . . .	379
17.2.2	Options . . . . .	382
17.3	Forwarding . . . . .	383
17.3.1	Forwarding . . . . .	383
<b>Chapter 18</b>	<b>WAN. . . . .</b>	<b>384</b>
18.1	Internet + Dialup . . . . .	384
18.1.1	PPPoE . . . . .	385
18.1.2	PPTP . . . . .	391
18.1.3	PPPoA . . . . .	395
18.1.4	ISDN . . . . .	400
18.1.5	UMTS/LTE. . . . .	408
18.1.6	IP Pools . . . . .	411
18.2	ATM . . . . .	412
18.2.1	Profiles . . . . .	413
18.2.2	Service Categories . . . . .	417
18.2.3	OAM Controlling . . . . .	419
18.3	Real Time Jitter Control . . . . .	423
18.3.1	Controlled Interfaces . . . . .	423
<b>Chapter 19</b>	<b>VPN . . . . .</b>	<b>425</b>
19.1	IPSec . . . . .	425

19.1.1	IPSec Peers . . . . .	426
19.1.2	Phase-1 Profiles . . . . .	442
19.1.3	Phase-2 Profiles . . . . .	449
19.1.4	XAUTH Profiles . . . . .	453
19.1.5	IP Pools . . . . .	455
19.1.6	Options . . . . .	455
19.2	be.IP Secure Client . . . . .	459
<b>Chapter 20</b>	<b>Firewall . . . . .</b>	<b>460</b>
20.1	Policies . . . . .	461
20.1.1	IPv4 Filter Rules . . . . .	462
20.1.2	IPv6 Filter Rules . . . . .	464
20.1.3	Options . . . . .	466
20.2	Interfaces . . . . .	468
20.2.1	IPv4 Groups . . . . .	468
20.2.2	IPv6 Groups . . . . .	469
20.3	Addresses . . . . .	469
20.3.1	Address List . . . . .	469
20.3.2	Groups . . . . .	470
20.4	Services . . . . .	471
20.4.1	Service List . . . . .	471
20.4.2	Groups . . . . .	473
20.5	Configuration. . . . .	474
20.5.1	SIF - Configuration example . . . . .	474
<b>Chapter 21</b>	<b>Local Services . . . . .</b>	<b>479</b>
21.1	DNS . . . . .	479
21.1.1	Global Settings . . . . .	480
21.1.2	DNS Servers . . . . .	483
21.1.3	Static Hosts . . . . .	485

21.1.4	Domain Forwarding . . . . .	486
21.1.5	Dynamic Hosts . . . . .	487
21.1.6	Cache . . . . .	487
21.1.7	Statistics . . . . .	488
21.2	HTTPS . . . . .	488
21.2.1	HTTPS Server . . . . .	489
21.3	DynDNS Client . . . . .	489
21.3.1	DynDNS Update . . . . .	490
21.3.2	DynDNS Provider . . . . .	491
21.4	DHCP Server . . . . .	493
21.4.1	IP Pool Configuration . . . . .	493
21.4.2	DHCP Configuration . . . . .	494
21.4.3	IP/MAC Binding . . . . .	498
21.4.4	DHCP Relay Settings . . . . .	499
21.4.5	DHCP - Configuration example . . . . .	500
21.5	DHCPv6 Server . . . . .	503
21.5.1	DHCPv6 Server . . . . .	505
21.5.2	DHCPv6 Global Options . . . . .	506
21.5.3	Stateful Clients . . . . .	508
21.5.4	Stateful Clients Configuration. . . . .	508
21.6	CAPI Server . . . . .	509
21.6.1	User . . . . .	509
21.6.2	Options . . . . .	510
21.7	Scheduling . . . . .	511
21.7.1	Trigger . . . . .	511
21.7.2	Actions . . . . .	517
21.7.3	Options . . . . .	528
21.7.4	Configuration example - Time-controlled Tasks (Scheduling) . . . . .	528
21.8	Surveillance . . . . .	531
21.8.1	Hosts . . . . .	531

21.8.2	Interfaces . . . . .	534
21.8.3	Ping Generator . . . . .	535
21.9	UPnP . . . . .	536
21.9.1	Interfaces . . . . .	536
21.9.2	General . . . . .	537
21.10	HotSpot Gateway . . . . .	538
21.10.1	HotSpot Gateway . . . . .	540
21.10.2	Options . . . . .	543
21.11	Wake-On-LAN . . . . .	543
21.11.1	Wake-On-LAN Filter . . . . .	544
21.11.2	WOL Rules . . . . .	547
21.11.3	Interface Assignment . . . . .	549
21.12	Trace Interface . . . . .	549
21.12.1	Trace Interface . . . . .	550
<b>Chapter 22</b>	<b>Maintenance . . . . .</b>	<b>551</b>
22.1	Log out Users . . . . .	551
22.1.1	Log out Users . . . . .	551
22.2	Diagnostics . . . . .	552
22.2.1	Ping Test . . . . .	552
22.2.2	DNS Test . . . . .	552
22.2.3	Traceroute Test . . . . .	552
22.3	Memory Card . . . . .	553
22.3.1	Memory Card . . . . .	553
22.4	Software & Configuration . . . . .	553
22.4.1	Options . . . . .	554
22.5	Update System Phones . . . . .	558
22.5.1	elmeg System Phones . . . . .	558
22.5.2	elmeg OEM . . . . .	560

22.5.3	Firmware Files . . . . .	562
22.5.4	Settings . . . . .	563
22.6	Reboot . . . . .	563
22.6.1	System Reboot . . . . .	563
22.7	Factory Reset . . . . .	564
<b>Chapter 23</b>	<b>External Reporting . . . . .</b>	<b>565</b>
23.1	Syslog . . . . .	565
23.1.1	Syslog Servers . . . . .	565
23.2	IP Accounting . . . . .	567
23.2.1	Interfaces . . . . .	567
23.2.2	Options . . . . .	568
23.3	Alert Service . . . . .	569
23.3.1	Alert Recipient . . . . .	569
23.3.2	Alert Settings . . . . .	571
23.4	SNMP . . . . .	573
23.4.1	SNMP Trap Options . . . . .	573
23.4.2	SNMP Trap Hosts . . . . .	574
23.5	SIA . . . . .	574
23.5.1	SIA . . . . .	575
<b>Chapter 24</b>	<b>Monitoring . . . . .</b>	<b>576</b>
24.1	Status Information . . . . .	576
24.1.1	Users . . . . .	576
24.1.2	Teams . . . . .	577
24.2	Internal Log . . . . .	578
24.2.1	System Messages . . . . .	578
24.3	IPSec . . . . .	578
24.3.1	IPSec Tunnels . . . . .	578

24.3.2	IPSec Statistics . . . . .	580
24.4	Interfaces . . . . .	581
24.4.1	Statistics . . . . .	581
24.4.2	Network Status . . . . .	583
24.5	WLAN . . . . .	583
24.5.1	WLANx . . . . .	583
24.5.2	VSS . . . . .	584
24.5.3	Client Management . . . . .	586
24.5.4	Bridge Links . . . . .	586
24.6	Bridges . . . . .	588
24.6.1	br<x> . . . . .	588
24.7	HotSpot Gateway . . . . .	588
24.7.1	HotSpot Gateway . . . . .	588
24.8	QoS . . . . .	589
24.8.1	QoS . . . . .	589
<b>Chapter 25</b>	<b>User Access . . . . .</b>	<b>590</b>
25.1	Status . . . . .	590
25.2	Phonebook . . . . .	592
25.2.1	System Phonebook . . . . .	592
25.2.2	User Phonebook . . . . .	593
25.3	Call Data Records . . . . .	593
25.3.1	Outgoing . . . . .	593
25.3.2	Incoming . . . . .	594
25.4	Settings . . . . .	595
25.4.1	Feature Settings . . . . .	595
25.4.2	General Settings . . . . .	599
25.5	Assigned elmeg Phones . . . . .	600
25.5.1	Assigned elmeg Phones . . . . .	600



25.6	elmeg System Phones . . . . .	601
25.6.1	Assigned System Phones . . . . .	601
25.7	Voice Mail System . . . . .	616
25.7.1	Settings . . . . .	616
25.7.2	Messages . . . . .	619
	 Glossary. . . . .	 620
	 Index . . . . .	 658



# Chapter 1 Introduction

## 1.1 be.IP plus - world edition

This chapter will show you how to set your device up, connect it and get it working in just a few minutes.

We shall then explain, step-by-step, more detail about the configuration. No particular in-depth knowledge of telephone systems or routers is required. A detailed online help system gives you extra support.

The PDF version of this document contains a slim version of the manual. It comprises all information on installation as well as the description of all configuration parameters, but no screen shots. An HTML-based version containing the screen shots is available as a ZIP file in the download section of your device. Unpack the ZIP file into a folder of your choice and call "start.html" in a web browser.

### 1.1.1 Setting up and connecting

**be.IP plus - world edition** is operated at a purely IP-based connection. Telephony is exclusively VoIP-based, but your choice of connected devices is not restricted in any way. You can connect SIP, analogue and ISDN phones as well as PCs.

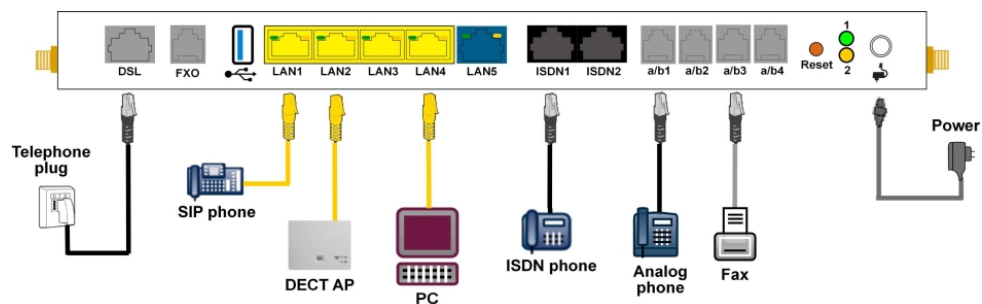

#### Caution

Please read the safety instructions carefully before installing and starting up your device.

**Caution**

Using an incorrect power supply unit may damage your device! You should only use the power supply unit provided!

Set up and connect in the following sequence:

- (1) Installation  
When operational, **be.IP plus - world edition** needs to be wall-mounted in an upright position or well ventilated inside of a device rack (please read chapter *Mounting* on page 13 carefully).
- (2) Mains connection  
Connect the network connection on the device with the power supply unit provided to a 230 V mains socket.
- (3) Antennas  
Screw the standard antennas supplied on to the connectors provided for this purpose
- (4) DSL  
Connect the **DSL** connector to the TAE plug using the grey cable.
- (5) ISDN telephones  
Connect an ISDN telephone at the internal ISDN connector of the **be.IP plus - world edition**.
- (6) Analogue telephones  
Connect your analogue terminals to the internal interfaces for analogue terminals (a/b1 - a/b4). To do this, use the cable provided with the terminal.
- (7) Analogue telephone connection:  
If you have an analogue phone connection, connect the FXO interface to the phone socket using a suitable cable. Please note that the FXO socket is an RJ12 socket.
- (8) SIP telephones  
Connect your SIP telephones to the 10/100/1000 Base-T Ethernet interfaces. In a last step connect your PC and follow the instructions from the installation poster.
- (9) PC  
Connect a suitable PC to one of the Ethernet ports of **be.IP plus - world edition** using an Ethernet cable. Should you run into any problems with the connection between your PC and your **be.IP plus - world edition**, read the corresponding sections on the basic configuration of your device.
- (10) VoIP  
For a pure IP connection without ISDN refer to the instruction provided by your service provider.

## 1.1.2 Connectors

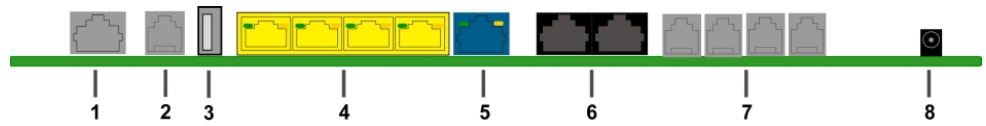

1	DSL interface Annex B/J
2	External interface for analogue terminals FXO
3	USB interface
4	10/100/1000 Base-T Ethernet interface (LAN1 - LAN4)
5	Etherne WAN interface (LAN5)
6	Interface for ISDN telephones (ISDN1, ISDN2)
7	Internal interface for analogue telephones (a/b1 - a/b 4)
8	Socket for the power supply unit

## 1.1.3 Connections (on the side)

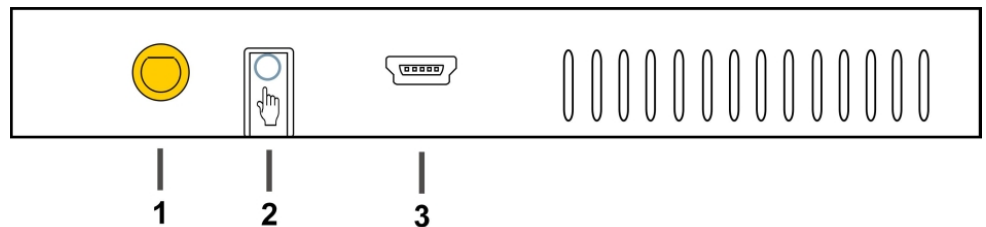

1	Antenna connector
2	Function key
3	Console

## 1.1.4 Mounting brackets

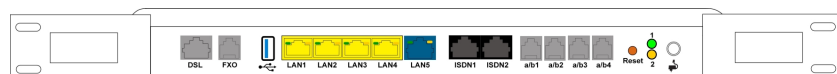

Due to the position of the devices in a rack it is recommended to use remote antenna. Attach the mounting brackets to the device using the supplied screws. The mounting brackets and screws are available as an accessory (Part No. MN40285514).

**Note**

During operation in a rack the ambient temperature must not exceed 40 °C.

## 1.1.5 LEDs

The LEDs provide information on the device's activities and statuses.

The LEDs on your **be.IP plus - world edition** are arranged as follows:

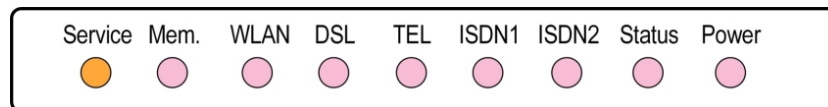

In operation mode, the LEDs display the following status information for your device:

### LED status display

LED	Status	Information
Service	on	Undergoing automatic maintenance (is currently not supported)
	off	No automatic maintenance
Mem.	off	Memory is ready for read/write accesses
	flickering	Read/write accesses
WLAN	off	WLAN or all assigned wireless networks disabled
	slow flashing	Wireless network is enabled, no client is logged in
	flashing quickly	Wireless network is enabled, at least one client is logged in
	flickering	Wireless network is enabled, at least one client is logged in, there is some data traffic
DSL	on	Connection established
	slow flashing	Synchronisation running
	off	No synchronisation
	flickering	Data transfer
TEL	on	Telephony ready at IP connector (Voice over IP)
	off	Telephony not configured
ISDN1 / ISDN 2	on	ISDN telephone system connected
	off	On standby or not functioning

LED	Status	Information
Status	on	After switching on: Device is started While operation: Fault
	slow flashing	The device is active
Power	on	The power supply is connected
	off	No power supply

The LEDs for the Ethernet sockets LAN 1-4 (LAN) and LAN5 (WAN) show the following status information:

### Ethernet-LEDs

LED	Colour	Status	Information
LAN 1 to 4 (Link/Act)	Green	on	Ethernet connection established
LAN 1 to 4 (Link/Act)	Green	flashing	Data transmission via Ethernet
LAN 1 to 4 (Link/Act)		off	No Ethernet connection
LAN 1 to 4 (Speed)	Green	on	1000 Mbit/s transfer rate
LAN 1 to 4 (Speed)	Orange	on	100 Mbit/s transfer rate
LAN 1 to 4 (Speed)		off	10 Mbit/s transfer rate
LAN 5 (Link/Act)	Green	on	WAN Ethernet connection established
LAN 5 (Link/Act)	Green	flashing	Data transmission via ETH5t
LAN 5 (Link/Act)		off	No Ethernet connection
LAN 5 (Speed)	Green	on	1000 Mbit/s transfer rate
LAN 5 (Speed)	Orange	on	100 Mbit/s transfer rate
LAN 5 (Speed)		off	10 Mbit/s transfer rate

### LEDs back view

The LEDs are linked to those on the top of the device and show the identical behavior.



1 Status Green

2 Service Yellow (currently unsupported)

## 1.1.6 Scope of supply

Your device is supplied with the following parts:

Product Name	Cables/Accessories	Documentation
<b>be.IP plus - world edition</b>	One Ethernet LAN cable (yellow)	Installation poster
	One Ethernet WAN cable (blue)	Safety instructions
	One DSL cable (grey)	
	Two FXS adapter for analogue devices (black)	
	Power supply unit	
	Two Wi-Fi antennas	

## 1.1.7 General Product Features

Die allgemeinen Produktmerkmale umfassen die Leistungsmerkmale und die technischen Voraussetzungen für Installation und Betrieb Ihres Geräts.

### General Product Features be.IP plus - world edition

<b>Property</b>	
<b>Dimensions and weights:</b>	
Equipment dimensions without cable (B x H x D):	328 x 193 x 44 mm
Weight	approx. 900 g
Transport weight (incl. documentation, cables, packaging)	approx. 1,800 g
Memory	128 MB SDRAM
LEDs	19 (8x Function, 1 x Service, 5x2 Ethernet)
Power consumption of the device	max. 30 W 12 V DC
Voltage supply	12 V DC, 2,5 A
<b>Environmental requirements:</b>	



<b>Property</b>	
Storage temperature	-20 °C to +70 °C
Operating temperature	+5 °C to +40 °C
Relative atmospheric humidity	max. 85%
Room classification	Operate only in dry rooms
<b>Available interfaces:</b>	
DSL interface	Internal DSL modem
Ethernet IEEE 802.3 LAN (4-port switch)	Permanently installed (twisted pair only), 10/100/1000 mbps, autosensing, MDIX
ISDN interfaces	2 internal ISDN interfaces, ISDN termination
FXS	4 FXS interfaces (a/b1 - a/b4)
FXO	1 FXO interface
Serial interface V.24	Permanently installed, supports Baud rates: 1200 to 115200 Baud
<b>Available sockets:</b>	
WLAN antennas	R-SMA socket
Ethernet interfaces 1- 4 (LAN)	RJ45 socket
Ethernet interface 5 (WAN)	RJ45 socket
ISDN interface (ISDN1, ISDN2)	RJ45 socket
FXS interface (a/b1 to a/b4)	RJ12 socket
FXO interface	RJ12 socket
DSL interface	RJ45 socket
Serial interface V.24	5-pole mini USB socket
USB	USB connection type A
Barrel connector socket for power supply	

## 1.2 Reset

The reset is performed by using the reset button at the terminal area.

The device is rebooted by quickly pressing the key (ca. one second). Pressing the key is equivalent to an interruption of the power supply. Saved data are preserved, but all connections are interrupted.

If you press the reset key for approx. 30 seconds, the device performs a factory reset. Connection data for incoming and for outgoing phone calls are preserved. The configuration is deleted and all passwords are reset.

The reset has finished once the status LED flashes continuously again after approx. 30 seconds.

## 1.3 Presettings

Certain settings have already been pre-configured so that it only takes you a few steps to start using your device for the first time.



### Note

Consult the user's guide for your existing terminals to find out how the features can be used and with which settings.

You can change these presettings to meet your personal requirements and connection situation.

### Telephony presettings

Analogue connections	Set up as telephone. Permanently set to <i>tone dialling (MFC)</i> .
Call waiting	Set up with analogue telephones (for FXS 4 but disabled where a fax or multifunctional unit is connected).
Manually switching call variants	Allowed.
Receive simplex operations	Allowed.
Announcement	Allowed.

Net Direct (keypad)	Allowed.
DoorLine permission	Allowed.
TAPI	Allowed.
Save connection data	Set up.
Outside line	Outside line via 0 is set up.
International prefix	Not set up.
Country code	Not set up.
National prefix	Not set up.
Area code	Not set up.
Currency for billing	Not set up.
Authorisation for the terminals	Unrestricted authorisation.
Dir. call	Not set up.
Own telephone number	Is sent to the caller.
External calls	Are signalled to all pre-configured internal numbers ( <i>Team All</i> ).
Call pickup	Set up.
Internal telephone numbers	For the <b>ISDN (BRI) internal</b> to the internal ISDN bus, the internal telephone numbers 30 and 35 are provided, for the analogue connections <b>FXS1 to FXS4</b> the internal telephone numbers 10 to 13 are provided, and for the system telephones the telephone numbers 20 and 21 are provided, for DECT systems the telephone number 22 is provided.
Pre-configured teams	Internal number 40: Team All

Misdial routing	To internal number <i>40</i> (Team All)
Team call forwarding	Allowed.
Voicemail system	For the internal nummber <i>10</i> and <i>20</i> provided.  With no PIN query.
Display in system phone book	Set up for all internal numbers.
Busy lamp field	Set up for all internal numbers.
Switching times (calendar)	Not set up.
Keypad function	Not set up.
PIN1	Not set up.
PIN 2	<i>000000</i>
Telephone number of the calling subscriber (CLIP)	Is displayed.
Standard MSN	<i>20 (#20)</i>
Device as internal time server	Set up.
Automatic Route Selection	Set up for all internal numbers, but no numbers set up.
Dialling control	Set up for all internal numbers, but no numbers set up.
Priority numbers	There are no priority numbers configured. Common numbers are:  Emergency call <i>110</i>  Emergency call <i>112</i>  Ambulance <i>19222</i>
Music on hold 1	<i>MOH Internal 1</i> set up.

Time for call forwarding	Time after set to <i>15</i> seconds.
Preset public holidays	There are no public holidays configured. Common holidays are:  01.01. New year  06.01. Twelfth Day  01.05. Labour Day  15.08. Feast of the Assumption  03.10. Day of German Unity  31.10. Reformation Day  01.11. All Saints' Day  25.12. 1. Christmas Day  26.11. 2. Boxing Day
IP address assignment to VoIP terminals and PCs in the LAN	Via DHCP servers with IP address range <i>192.168.0.10 - 192.168.0.30</i>  Time server: <i>192.168.0.251</i>  Provisioning server: <i>ht-tp://192.168.0.251/eg_prov</i>

## Configuration interface

In the ex works state, you can access your device's configuration interface through one of the LAN connections at this address:

- **IP Address:** *192.168.0.251*
- **Netmask:** *255.255.255.0*

In the ex works state, you should use the following access data to configure your device using the configuration interface:

- **User Name:** *admin*
- **Password:** *admin*

**Note**

After you log into the device for the first time, you will be prompted to enter a secure password. When you do this, please note the guidance that is displayed on secure passwords! When the configuration procedure is complete, select the **Save configuration** button! Otherwise the new, secure password will be lost when there is a restart.

## Select operating mode

**be.IP plus - world edition** allows you to switch between the operation modes of a PABX and that of a media gateway.

**Note**

After switching to the media gateway operation mode you can find an adequate documentation of the software in the manual of the **be.IP**.

Case 1: If the password has not yet been changed, you can select the **operating mode** once you log in.

Case 2: If the password has been changed, the device has been configured as a telephone system ex works. You can also change **operating mode** in the menu **Assistants+First Steps->Operating Mode**. Note that some features will not then be available. Assembly and the basic configuration are exactly the same.

**Note**

If you switch from telephone system to media gateway or from media gateway to telephone system, the device does a factory reset. This means that the device reverts to condition it was in when it was supplied. The configuration is deleted and all the passwords are reset.

## 1.4 Support-Information

If you have any questions about your new product, please contact a local, certified retailer for prompt technical support. Resellers have been trained by us and receive privileged support.

Further information on our support and service offers can be found on our web site at [www.bintec-elmeg.com](http://www.bintec-elmeg.com).

## Chapter 2 Mounting



### Warning

To avoid electric shocks, please take care when connecting telecommunications networks (TNV electric circuits). LAN ports also use RJ connectors.



### Caution

To ensure that the **be.IP plus - world edition** can operate free of faults, it must be mounted upright on a wall or well ventilated inside of a device rack. The device should not be exposed to direct sunlight or other sources of heat. Please note, too, the gaps that you need to comply with (see [Wall mounting](#) on page 14).

## 2.1 Connecting terminals

### 2.1.1 Internal ISDN connection

The internal ISDN connection on the **be.IP plus - world edition** gives each internal ISDN connection a 2.5 watt power supply for connecting a maximum of two unpowered ISDN terminals. In its ex works state, the internal ISDN connection is set up as a "short passive bus" ("S0 bus"). It is the simple bus cabling in an ISDN system with a length of up to 120 m.

### 2.1.2 Termination of ISDN interfaces

The switches for the termination of the ISDN interfaces are located at the bottom/underside of the device. In the ex works state, both switches are set to ON. In this setting, the termination is active, and the device is configured for all common applications.

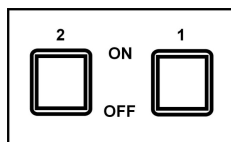

## 2.2 Reset button

The reset button which allows you to restart the device or to reset it to the ex works state is located at the terminal area (cf. [Reset](#) on page 8).

## 2.3 Wall mounting

The various assembly processes are described in this section. Please comply with these processes.

- (1) Find an installation site which is a maximum of 1.5 metres away from a 230 V mains socket and 2.5 metres from the network operator's transfer point.
- (2) To prevent devices interfering with each other, do not install the device close to electronic devices such as hi-fi systems, office equipment or microwave ovens. Neither should you install it near heat sources such as radiators, or in damp rooms.
- (3) Comply with the gaps as indicated at the bottom in the picture.
- (4) Mark the drilling holes in the wall.
- (5) Check that all the points where the **be.IP plus - world edition** is attached to the wall can bear its weight. Ensure that there are no utility lines, cables etc located in the area where the holes are marked.
- (6) Drill the holes at the points marked (if inserting into rawlplugs, use a 5 mm masonry drill). Insert the rawlplug.
- (7) Screw the top two screws in in such a way that there is still a gap of about 5 mm between the screw head and the wall.
- (8) Hang the **be.IP plus - world edition** with the rear brackets from above behind the screw heads.
- (9) If necessary, install the sockets for the terminals. Connect the socket installation to that of the device. The sockets are used for a permanent installation, for example in a hallway. When they are installed, the connecting cables are connected to the connectors on the device,
- (10) Plug the connectors on the device into the sockets.
- (11) Connect the **be.IP plus - world edition** to the external connections. To do this, you can follow the instructions given on the installation poster provided.
- (12) Plug the power supply unit into the 230 V socket.
- (13) Plug the barrel connector on the power supply unit into the corresponding socket on your device.
- (14) Now you are ready to use the device.



## 2.4 Pin Assignments

### 2.4.1 Ethernet interfaces

The devices feature an Ethernet interface with integrated 4 port switch (ETH1 - ETH4).

The 4-port switch is used to connect individual PCs or other switches. The connection occurs via RJ45 sockets.

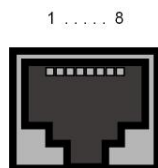

The pin assignment for the Ethernet 10/100/1000 Base-T interface (RJ45 connector) is as follows:

#### RJ45 socket for Ethernet connection

Pin	Function
1	Pair 0 +
2	Pair 0 -
3	Pair 1 +
4	Pair 2 +
5	Pair 2 -
6	Pair 1 -
7	Pair 3 +
8	Pair 3 -

### 2.4.2 ISDN interface

The connection is made via an RJ45 socket:

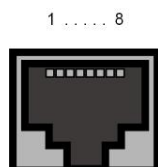

The pin assignment for the ISDN interface (RJ45 socket) is as follows:

**RJ45 socket for ISDN connection**

Pin	Function
1	Not used
2	Not used
3	Transmit (+)
4	Receive (+)
5	Receive (-)
6	Transmit (-)
7	Not used
8	Not used

**2.4.3 Analogue interfaces (FXS -/FXO)**

The terminals are connected to the FXS -/FXO interfaces (RJ12 socket) with an RJ11 plug.

The pin assignment for the FXS -/FXO interface (RJ12 socket) is as follows:

**RJ12 socket for FXS -/FXO connection**

Pin	Function
1	Not used
2	Not used
3	FXS
4	FXS
5	Not used
6	Not used

**2.4.4 xDSL interface**

The **be.IP plus - world edition** has an xDSL interface. The xDSL interface is connected via an RJ45 plug.

Only the two inner pins are used for the xDSL connection.

1 . . . . . 8

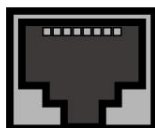

The pin assignment for the xDSL interface (RJ45 socket) is as follows:

#### RJ45 socket for xDSL connection

Pin	Function
1	Not used
2	Not used
3	Not used
4	Line 1a
5	Line 1b
6	Not used
7	Not used
8	Not used

### 2.4.5 Serial interface

Your device has a serial interface for connection to a console. This supports Baud rates from 1200 to 115200 Bps.

The interface is designed as a 5-pole mini USB socket.

1 . . . . . 5

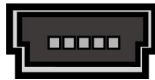

The pin assignment is as follows:

#### Pin assignment of the mini USB socket

Pin	Position
1	Not used
2	TxD
3	RxD
4	Not used
5	GND

### 2.4.6 USB interface

The devices have a USB connection for connecting a UMTS stick.

The interface is executed as a standard USB Type A socket.



The pin assignment is as follows:

#### Pin assignment in USB Type A socket

Pin	Position
1	Vbus
2	D-
3	D+
4	GND
Shell	Shield

## Chapter 3 Basic configuration

The way to obtain the basic configuration is explained below step-by-step. A detailed online help system gives you extra support.

### 3.1 Preparations

Your device is factory configured as a DHCP server so that it can provide PCs on your LAN that have no IP configuration with all the information required for a connection. How you set up the PC that you want to do the basic configuration on so that it automatically gets an IP configuration is described in [Setting up a PC](#) on page 21.



#### Note

If you already run a DHCP server on your LAN, it is recommended that you connect only a single PC to your **be.IP plus - world edition** so that a separate network is created.

#### 3.1.1 Systemsoftware

Your device contains the version of the system software available at the time of production. More recent versions may have since been released.

You can easily update it using the configuration interface in the **Maintenance->Software & Configuration** menu. For a description of the procedure, see [Software updates for be.IP plus - world edition](#) on page 25.

#### 3.1.2 System requirements

To configure the device, your PC must meet the following system requirements:

- Suitable operating system (Windows, Linux, MAC OS)
- A web browser (Internet Explorer, Firefox, Chrome) in the current version
- Installed network card (Ethernet)
- Installed TCP/IP protocol
- High colour display to show the graphics correctly

### 3.1.3 Gathering data

You will quickly collect the main data for doing the configuration with the configuration interface.

Before you start the configuration, you should gather the data for the following purposes:

- Network settings (only if you intend to integrate your device into an existing network infrastructure)
- SIP provider
- Internet access

The following table shows examples of possible values for the necessary access data. You can enter your personal data in the "Your values" column, so that you can refer to these values later when needed.

#### Basic configuration

For a basic configuration of your device, you need information that relates to your network environment:

##### Network settings

Access data	Example value	Your values
IP address of your gateway	192.168.0.251	
Netmask of your gateway	255.255.255.0	

##### SIP provider

Access data	Example value	Your values
Description	Enter the name of your SIP provider, e.g. <i>Sipgate</i> .	
Authentication ID	Enter you ID, e.g. your Email Address	
Password	Enter your password that you received from your SIP provider.	
Registrar	Enter the appropriate re-	

Access data	Example value	Your values
	<i>gistrar, e. g. sipgate.de.</i>	
Call number	<i>e. g. 123456</i>	

#### Data for internet access over xDSL

Access data	Example value	Your values
Provider name	<i>GoInternet</i>	
Protocol	<i>PPP over Ethernet (PPPoE)</i>	
Encapsulation	<i>LCC Bridged no FCS</i>	
VPI (Virtual Path Identifier)	<i>1</i>	
VCI (Virtual Circuit Identifier)	<i>32</i>	
Connection ID (12-digit)	<i>000123456789</i>	
T-Online number (usually 12 digits)	<i>06112345678</i>	
Joint user account	<i>0001</i>	
Password	<i>TopSecret</i>	

### 3.1.4 Setting up a PC

To access your device via the network and to be able to do a configuration using the configuration interface, the PC used for the configuration has to satisfy some prerequisites.

- Make sure that the TCP/IP protocol is installed on the PC.

#### Checking the TCP/IP protocol

Proceed as follows to check whether you have the protocol installed:

- (1) Click the Windows Start button and then **Settings -> Control Panel -> Network Connections** (Windows XP) or **Control Panel -> Network and Sharing Center-> Change Adapter Settings** (Windows 7).

- (2) Click on **LAN Connection**.
- (3) Click on **Properties** in the status window.
- (4) Look for the **Internet Protocol (TCP/IP)** entry in the list of network components.

### Installing the TCP/IP protocol

If you cannot find the **Internet Protocol (TCP/IP)** entry, install the TCP/IP protocol as follows:

- (1) First click **Properties**, then **Install** in the status window of the **LAN Connection**.
- (2) Select the **Protocol** entry.
- (3) Click **Add**.
- (4) Select **Internet Protocol (TCP/IP)** and click on **OK**.
- (5) Follow the on-screen instructions and restart your PC when you have finished.

### Configuring a Windows PC as a DHCP client

Assign an IP address to your PC as follows:

- (1) Initially, proceed as described to display the network properties.
- (2) Select **Internet Protocol (TCP/IP)** and click on **Properties**.
- (3) Choose **Determine IP address automatically**.
- (4) Also choose **Determine DNS server address automatically**.
- (5) Close all the windows by selecting **OK**.

Your PC should now meet all the prerequisites for configuring your device.



#### Note

You can now launch the configuration interface for doing the configuration by entering the preconfigured IP address of your device (192.168.0.251) in a supported browser (Internet Explorer 6 or later, Mozilla Firefox 1.2 or later) and entering the pre-set login data (**User:** *admin*, **Password:** *admin*).

## 3.2 Configuring the system



### 3.2.1 Network setting (LAN)

If you intend to integrate your device into an existing network infrastructure, select the **Assistants->First steps->Basic Settings** menu for the network settings. For the LAN IP configuration, the **Address Mode** is set to **Static** by default, since your system is delivered ex works with a fixed IP. Enter the necessary **IP Address** for your device in your LAN and the associated **Netmask**. Leave all the other settings and click **OK**. Save the configuration by clicking on the Save Configuration button above the menu navigation.

### 3.2.2 Enter SIP provider

As an option, you may enter SIP providers for external telephone connections. Please note the description in the online help for the menu **VoIP->Settings->SIP Provider->New**.

## 3.3 Setting up an internet connection

You can establish an Internet connection with your device.

### 3.3.1 Internet connection via the internal VDSL modem

To make it easier to configure an VDSL internet connection, the configuration interface has a wizard to guide you through the connection set-up process simply and quickly.

- (1) In the user interface, go to the **Assistants->Internet** menu.
- (2) Use **New** to create a new entry, and copy the **Connection Type** *Internal ADSL Modem*.
- (3) Follow the steps shown by the wizard. The wizard has its own online help, which offers all of the information you may require.
- (4) Once you have exited the wizard, save the configuration by clicking on the **Save configuration** button above the menu navigation.

### 3.3.2 Other internet connections

In addition to an VDSL connection over the internal VDSL modem, you can connect your device to the internet with other types of connection or via an external modem. The **Internet** wizard in the configuration interface provides support with configurations of this type.

### 3.3.3 Testing the configuration

Once you have finished configuring your device, you can test the connection in your LAN and to the Internet.

Carry out the following steps to test your device:

- (1) Test the connection from any device in the local network to your device. In the Windows Start menu, click **Run** and enter `ping` followed by a space and then the IP address of your device (e.g. `192.168.0.251`). A window appears with the message "Reply from...".
- (2) Test the Internet access by entering [www.bintec-elmeg.com](http://www.bintec-elmeg.com) in the Internet browser.



#### Note

Incorrectly configured terminals may lead to unwanted connections and higher charges! Monitor your device and make sure it only sets up connections at the times you want it to. Watch the light indicators on your device (indicators for ISDN, DSL and the Ethernet interfaces).

## 3.4 User access

Those who administer and set up the system can set up a personalised configuration access for the users. This will enable the users to view their main personal settings and customise some of them.



#### Note

Those who administer and set up the system can access the settings and data of all the users. It is only the personal telephone book (**User Phonebook**) which the user can set up for themselves which can only be managed and viewed with the personal user login data.

To log into the configuration interface with the access data you have been assigned, enter your **user name** and your **password** in the login window.

The administrator configures the user accesses in the **Numbering->User Settings->Users** menu.

Users can also find help with the available configuration options in the online help system.

## 3.5 Software updates for be.IP plus - world edition

The range of functions in the **be.IP plus - world edition** is continuously being extended. For new software versions can be carried out easily with the **GUI**.

A functional Internet connection is required for any kind of an automatic update.

Proceed as follows:

- (1) Go to the **Maintenance->Software & Configuration** menu.
- (2) Select under **Action** *Update system software* and under **Source Location** *Current software from Update Server*.
- (3) Confirm with **Go**.

Alternatively, you can carry out a software update in the **User** view. On the **Status** page, click **Update** under **Firmware Update** to start the process. Do not interrupt the Internet connection or the power supply.

After installation of the new system software, the system must be restarted.

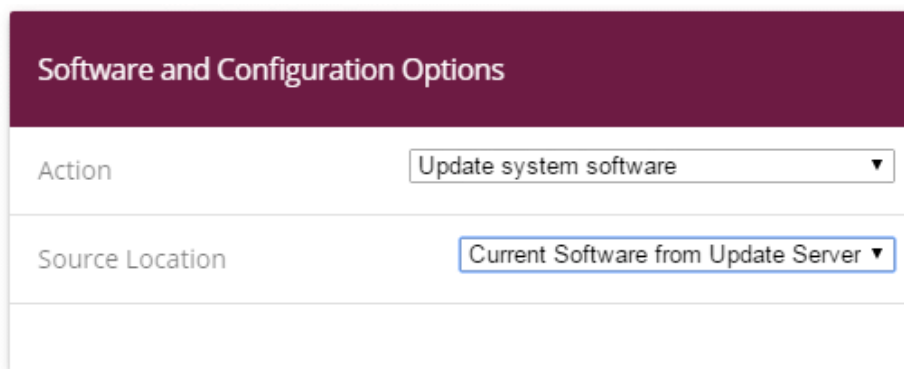

The screenshot shows a dialog box titled "Software and Configuration Options". It contains two dropdown menus. The first dropdown, labeled "Action", is set to "Update system software". The second dropdown, labeled "Source Location", is set to "Current Software from Update Server".

**START**

The device will now connect to the download server and check whether an updated version of the system software is available. If so, your device will be updated automatically. When installation of the new software is complete, you will be invited to restart the device.

**Caution**

Once you have clicked on **Go** the update cannot be cancelled/interrupted. If an error occurs during the update, do not re-start the device and contact support.

## Chapter 4 Operation via the telephone

The operation and configuration of the system via a connected telephone is described in two separate documents. You will find the document as download under <http://www.bintec-elmeg.com>

## Chapter 5 Access and configuration

### 5.1 Access via LAN

Access via one of your device's Ethernet interfaces allows you to open the configuration interface in a web browser.

#### 5.1.1 HTTP/HTTPS

With a current web browser, you can use the HTML interface to configure your device. For this, enter the following in your web browser's address field

- `http://192.168.0.251`

or

`https://192.168.0.251`

### 5.2 Configuration

The configuration is done using the HTML configuration interface.

#### 5.2.1 Configuration interface

The configuration interface is a web-based graphic user surface that you can use from any PC with an up-to-date Web browser via an HTTP or HTTPS connection.

With the configuration interface you can perform all the configuration tasks easily and conveniently. It is integrated in your device and is available in English.

The settings you make are applied with the **OK** or **Apply** button in the relevant menu, and you do not have to restart the device.

If you finish the configuration and want to save your settings so that they are loaded as the boot configuration when you reboot your device, save these by clicking the **Save configuration** button.

You can also use the configuration interface to monitor the most important function parameters of your device.

### 5.2.1.1 Open the configuration interface

- (1) Check whether the device is connected and switched on and that all the necessary cables are correctly connected.
- (2) Check the settings of the PC from which you want to configure your device.
- (3) Open a web browser.
- (4) Enter `http://192.168.0.251` in the address field of the web browser.
- (5) You will be prompted to change the administrator password. Change the login password.

You are now in the status menu of your device's configuration interface.

### 5.2.1.2 Operating elements



#### Configuration interface window

The configuration interface window is divided into three areas:

- The header
- The navigation bar
- The main configuration window

#### Header

##### Configuration interface header bar

Menu	Function
	Opens the navigation bar.
<b>HOME</b>	In the view of <b>User</b> executes each menu to the start page.
<b>Logout</b>	<p><b>Logout:</b> If you want to end the configuration, click this button to log out of your device. A window is opened offering you the following options:</p> <ul style="list-style-type: none"> <li>• Continue with the configuration,</li> <li>• Save the configuration and close the window,</li> <li>• Exit the configuration without saving.</li> </ul>
	<p><b>Online Help:</b> Click this button if you want help with the menu now active. The description of the sub-menu where you are now is displayed.</p>

Menu	Function
<p><b>LANGUAGE</b></p> <p>English</p> <p>Deutsch</p>	<p><b>Language:</b> From the dropdown menu, select the language in which the configuration interface is to be displayed. Here, you can select the language in which you want to carry out the configuration. <i>German</i> and <i>English</i> are available.</p>
<p><b>VIEW</b></p> <p>Initial operation</p> <p>User</p> <p>Expert</p> <p>Full Access</p>	<p><b>View:</b> Select the desired view from the dropdown menu. <i>Full Access</i>, <i>Expert</i> and <i>User</i> can be selected. Also the Initial operation can be start again from here.</p>
<p><b>SAVE CONFIGURATION</b></p>	<p>Save configuration button.</p> <p>If you click the <b>Save configuration</b> button, you will be asked "Do you really want to save the current configuration as a boot configuration?"</p> <p>You can</p> <ul style="list-style-type: none"> <li>• Save configuration</li> <li>• Save configuration with boot backup</li> </ul>

### Navigation bar

The navigation bar contains the main configuration menus and their sub-menus.

Click the main menu you require. The corresponding sub-menu then opens.

If you go to the sub-menu you want, the entry selected will be displayed in color. After selecting the sub-menu the navigation bar will be closed.



### Status page

If you open the configuration interface the status page of your device is displayed after you log in. The most important data of your device can be seen on this at a glance.

### Main configuration window

The sub-menus generally contain several pages. These are called using the buttons at the top of the main window. If you click a button, the window is opened with the basic parameters. You can extend this by clicking the **Advanced Settings** tab, which displays the additional options.



### Configuration elements















The various actions that you can perform when configuring your device in the configuration interface are triggered by means of the following buttons:

#### Buttons

Button	Function
<b>APPLY</b>	Updates the view.
<b>CANCEL</b>	If you do not want to save a newly configured list entry, cancel this and any settings made by pressing <b>Cancel</b> .
<b>OK</b>	Confirms the settings of a new entry and the parameter changes in a list.
<b>GO</b>	Immediately starts the configured action.
<b>NEW</b>	Calls the sub-menu to create a new entry.
<b>ADD</b>	Inserts an entry in an internal list.



#### Symbols

Icon	Function
	Deletes the list entry.
	Displays the menu for changing the settings of an entry.
	Displays the details for an entry.

Icon	Function
	Voicemail message can be intercepted.
	Messages will be saved.
	Select the button to go to the <b>elmeg IP1x0</b> telephone user interface administrator page.
	Moves an entry. A combo box opens in which you can choose the list entry that selected entry is to be placed in front of/after.
	Creates another list entry first and opens the configuration menu.
	Sets the status of the entry to <i>Inactive</i> .
	Sets the status of the entry to <i>Active</i> .
	Indicates "Dormant" status for an interface or connection.
	Indicates "Up" status for an interface or connection.
	Indicates "Down" status for an interface or connection.
	Indicates "Blocked" status for an interface or connection.
	Indicates that data traffic is encrypted.
	Triggers a WLAN bandscan.
	Displays the next page in a list.
	Displays the previous page in a list.

#### List options

Menu	Function
Update Interval	Here you can set the interval in which the view is to be updated.  To do this, enter a period in seconds in the input field and con-

Menu	Function
	firm it with <b>APPLY</b> .
Filter	<p>You can have the list entries filtered and displayed according to certain criteria.</p> <p>You can determine the number of entries displayed per page by entering the required number in <b>Viewxper page</b>.</p> <p>Use the  and  buttons to scroll one page forward and one page back.</p> <p>You can filter according to certain keywords within the configuration parameters by selecting the filter rule you want under <b>Filter in x &lt;Option&gt; y</b> and entering the search word in the input field. <b>GO</b> launches filter operation.</p>
Configuration elements	<p>Some lists contain configuration elements.</p> <p>You can therefore change the configuration of the corresponding list entry directly in the list.</p>

On the **status page** you can open the option **Automatic Refresh Interval** using the button .

Click **Automatic Refresh Interval** .



Enter the time and click **APPLY** .

### Structure of the configuration menu

The menus contain the following basic structures:





#### Menu structure

Menu	Function
Basic configuration menu/list	<p>When you select a menu from the navigation bar, the menu of basic parameters is displayed first. In a sub-menu containing several pages, the menu containing the basic parameters is displayed on the first page.</p> <p>The menu contains either a list of all the configured entries or</p>

Menu	Function
	the basic settings for the function concerned.
Sub-menu 	The <b>New</b> button is available in each menu in which a list of all the configured entries is displayed. Click the button to display the configuration menu for creating a new list entry.
Sub-menu 	Click this button to process the existing list entry. You go to the configuration menu.
Menu 	Click this tab to display extended configuration options.

The following options are available for the configuration:

### Configuration elements

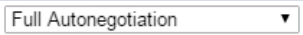
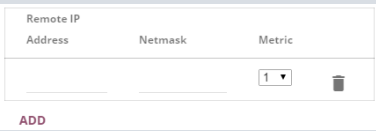
Menu	Function
Eingabefelder	e.g. empty text field  Text field with hidden input  Enter the data.
Radiobuttons	e.g.  Select the corresponding option.
Checkbox	e.g. activation by selecting checkbox 
Dropdown-Menüs	e.g.  Click the arrow to open the list. Select the required option using the mouse.
Interne Listen	e.g.  Click <b>ADD</b> . A new list entry is created. Enter the corresponding data. If list input fields remain empty, these are not saved when

Menu	Function
	you confirm with <b>OK</b> . Delete the entries by clicking the  icon.

### Display of options that are not available

Options that are not available because they depend on the selection of other options are generally hidden. If the display of these options could be helpful for a configuration decision, they are instead greyed out and cannot be selected.



#### Important

Please look at the messages displayed in the sub-menus. These provide information on any incorrect configurations.

### 5.2.1.3 Menus

The configuration options of your device are contained in the sub-menus, which are displayed in the navigation bar in the left-hand part of the window.



#### Note

Please note that not all devices have the full range of functions. Use your product specification to check which software your device has.

## Chapter 6 Assistants

The **Assistants** menu offers step-by-step instructions for the following basic configuration tasks:

- **Initial operation Telekom**
- **First steps**
- **Internet**
- **WLAN**
- **Telephony**
- **VPN**

Choose the corresponding task from the navigation bar and follow the instructions and explanations on the separate pages of the Wizard.

## Chapter 7 System Management

The **System Management** menu contains general system information and settings.

You see a system status overview. Global system parameters such as the system name, date/time, passwords and licences are managed and the access and authentication methods are configured.

### 7.1 Status

If you log into the **GUI**, your device displays the status page in the **Users** view.

Here you can find links to the configuration assistants that will support you with an easy configuration of the most important settings.

Moreover, you can carry out a **Firmware Update**. Click **Update** to start the process.



#### Note

Do not interrupt the Internet connection or the power supply.

After installation of the new system software, the system must be restarted.

In the **Full Access** and **Expert** views of your device, the status page displays the most important system information.

You see an overview of the following data:

- System status
- Your device's activities: Resource utilisation, active sessions and tunnels
- Status and basic configuration of the LAN, WAN, ISDN, and ADSL interfaces
- Information on plugged add-on modules (if any)

You can customise the update interval of the status page by entering the desired period in seconds as **Automatic Refresh Interval** and clicking on the **Apply** button.



#### Caution

Under **Automatic Refresh Interval** do not enter a value of less than 5 seconds, otherwise the refresh interval of the screen will be too short to make further changes!

The menu **System Management->Status** consists of the following fields:

#### Fields in the System Information menu.

Field	Value
<b>Uptime</b>	Displays the time past since the device was rebooted.
<b>System Date</b>	Displays the current system date and system time.
<b>Serial Number</b>	Displays the device serial number.
<b>BOSS Version</b>	Displays the currently loaded version of the system software.
<b>Last configuration stored</b>	Displays day, date and time of the last saved configuration (boot configuration in flash).
<b>Night Mode Status</b>	Displays whether your device is in normal operation ( <i>Off</i> ) or in night operation ( <i>On</i> ).

#### Fields in the Resource Information menu.

Field	Value
<b>CPU Usage</b>	Displays the CPU usage as a percentage.
<b>Memory Usage</b>	Displays the usage of the working memory in MByte in relation to the available total working memory in MByte. The usage is also displayed in brackets as a percentage.
<b>Memory Card</b>	Shows the status of any optional external memory card that has been inserted, and the size of the memory in GBytes or MBytes.
<b>Active Sessions (SIF, RTP, etc... )</b>	Displays the total of all SIF, TDRS, and IP load balancing sessions.
<b>Active IPSec Tunnels</b>	Displays the number of currently active IPSec tunnels in relation to the number of configured IPSec tunnels.

#### Fields in the Modules menu

Field	Value
<b>DSP Module</b>	Shows the type of plugged DSP module if any. An acquired fax licence, if any, can be displayed.

#### Fields in the VoIP Trunk Lines menu

Field	Value
<b>No.</b>	Displays the consecutive number of the SIP provider (your IP telephony provider).
<b>Description</b>	Displays the description of the SIP provider that has been



Field	Value
	entered upon creation of the provider.
<b>Registrar</b>	Displays the server your system connects to in order to enable IP phone calls.
<b>Access Type</b>	Displays if your connection is a point to multipoint or point to point (DDI) connection.
<b>Status</b>	Displays the current status of the connection to this SIP provider.

#### Fields in the **Physical Interfaces** menu.

Field	Value
<b>Interface - Connection Information - Link</b>	The physical interfaces are listed here and their most important settings are shown (ISDN: only the first 4 ports are listed). The system also displays whether the interface is connected or active.

#### Fields in the **WAN Interfaces** menu.

Field	Value
<b>Description - Connection Information - Link</b>	All the WAN interfaces are listed here and their most important settings are shown. The system also displays whether the interface is active.

## 7.2 Global Settings

The basic system parameters are managed in the **Global Settings** menu.

### 7.2.1 System

The **System Management->Global Settings->System** menu is used for entering your system's basic data.

The **System Management->Global Settings->System** menu consists of the following fields:

#### Fields in the menu **Basic Settings**

Field	Value
<b>System Name</b>	Enter the system name of your device. This is also used as the PPP host name.

Field	Value
	<p>A character string of up to 255 characters is possible.</p> <p>The device type is entered as the default value.</p>
<b>Location</b>	Enter the location of your device.
<b>Contact</b>	<p>Enter the relevant contact person. Here you can enter the e-mail address of the system administrator, for example.</p> <p>A character string of up to 255 characters is possible.</p> <p>Only for compact systems: The default value is <i>BINTECELMEG</i>.</p>
<b>Maximum Number of Syslog Entries</b>	<p>Enter the maximum number of syslog messages that are stored internally in the device.</p> <p>Possible values are <i>0</i> to <i>1000</i>.</p> <p>The default value is <i>50</i>. You can display the stored messages in <b>Monitoring-&gt;Internal Log</b>.</p>
<b>Maximum Message Level of Syslog Entries</b>	<p>Select the priority of system messages above which a log should be created.</p> <p>System messages are only recorded internally if they have a higher or identical priority to that indicated, i.e. all messages generated are recorded at syslog level <i>Debug</i>.</p> <p>Possible values:</p> <ul style="list-style-type: none"> <li>• <i>Emergency</i>: Only messages with emergency priority are recorded.</li> <li>• <i>Alert</i>: Messages with emergency and alert priority are recorded.</li> <li>• <i>Critical</i>: Messages with emergency, alert and critical priority are recorded.</li> <li>• <i>Error</i>: Messages with emergency, alert, critical and error priority are recorded.</li> <li>• <i>Warning</i>: Messages with emergency, alert, critical, error and warning priority are recorded.</li> <li>• <i>Notice</i>: Messages with emergency, alert, critical, error, warning and notice priority are recorded.</li> </ul>

Field	Value
	<ul style="list-style-type: none"> <li>• <i>Information</i> (default value): Messages with emergency, alert, critical, error, warning, notice and information priority are recorded.</li> <li>• <i>Debug</i>: All messages are recorded.</li> </ul>
<b>Maximum Number of Accounting Log Entries</b>	<p>Enter the maximum number of login process entries that are stored internally in the device.</p> <p>Possible values are <i>0</i> to <i>1000</i>.</p> <p>The default value is <i>20</i>.</p>
<b>Show Manufacturer Names</b>	<p>Here you can determine if the manufacturer part of a MAC address is to be "translated". The manufacturer part takes up to eight characters at the beginning of the MAC address. Instead of, e.g., <i>00:a0:f9:37:12:c9</i>, <i>BintecCo_37:12:c9</i> is displayed if this option is enabled.</p>

### Transfer to busy subscriber

You can define in the configuration whether a call can be transferred to a busy subscriber or, if it is off, that the caller will hear the engaged tone so that the call is terminated. Otherwise the caller is held and hears the ringing tone or the on-hold music. If the destination subscriber hangs up, the held subscriber hears the ringing tone. The destination subscriber is called and can take the held call.

### Fields in the menu System Settings

Field	Value
<b>Transfer Signalling</b>	<p>Specify how the call is to be transferred to an internal extension.</p> <p>Possible values:</p> <ul style="list-style-type: none"> <li>• <i>With the ringing tone</i> (the default value): Caller hears the ringing tone while being transferred.</li> <li>• <i>With music on hold (MoH)</i>: The caller hears the system's on-hold music while being transferred.</li> </ul>
<b>Transfer to busy extension</b>	<p>Set whether a caller may be transferred to a busy subscriber.</p> <p>The function is activated with <i>Enabled</i>.</p> <p>The function is disabled by default.</p>

Field	Value
<b>Rerouting to Number</b>	<p>Set the destination to which incoming calls should be diverted to, e. g. in the case of a misdial.</p> <p>Possible values:</p> <ul style="list-style-type: none"> <li>• <i>None - Busy Tone</i>: The caller hears the engaged tone by default and cannot be redirected to a destination.</li> <li>• <i>&lt;Extension number&gt;</i>: By default, the incoming call is routed to the number selected.</li> </ul> <p>The default value is the preset internal number <i>40 (Team global)</i>.</p>
<b>Interconnect external calls</b>	<p>When brokering with two external subscribers, select whether they are to be connected after you hang up.</p> <p>The function is activated with <i>Enabled</i>.</p> <p>The function is disabled by default.</p>

## Country settings

Your business is an international company with subsidiaries in several countries. Despite the differences in network implementation in the different countries, you want to use the same system in each subsidiary. By setting the respective country variants, the system can be adjusted to the particular features of the network in the required country.

As the system requirements vary from country to country, the functionality of certain features needs to be customised. The basic settings for different country variants are stored in the system.

### Fields in the menu Country Settings

Field	Value
<b>Country Profile</b>	<p>Select the country in which you want to use the system.</p> <p>Note: This does not change the language of the text in the system menu of system telephones.</p> <p>Possible values:</p> <ul style="list-style-type: none"> <li>• <i>Deutschland</i> (default value)</li> <li>• <i>Nederland</i></li> <li>• <i>Great Britain</i></li> </ul>

Field	Value
	<ul style="list-style-type: none"> <li>• <i>België</i></li> <li>• <i>Italia</i></li> <li>• <i>Danmark</i></li> <li>• <i>España</i></li> <li>• <i>Sverige</i></li> <li>• <i>Norge</i></li> <li>• <i>France</i></li> <li>• <i>Portugal</i></li> <li>• <i>Österreich</i></li> <li>• <i>Schweiz</i></li> <li>• <i>Česko</i></li> <li>• <i>Slovenija</i></li> <li>• <i>Polska</i></li> <li>• <i>Magyarország</i></li> <li>• <i>Ellada</i></li> </ul>
<b>International Prefix / Country Code</b>	<p>Enter the country code.</p> <p>You need this entry if, e. g., you wish to automatically generate an international number under <b>SIP Provider</b>. You dial, as usual, the national prefix e. g. 05151 909999 and the system then automatically dials +495151 909999. If you fail to enter the country code, you may misdial, as the system will then dial +5151 909999. Without the entry <b>Generate international phone number</b> and <b>International Prefix / Country Code</b>, the full number plus the country code always has to be dialled in the case of SIP providers.</p> <p>Note: Not every SIP provider supports this setting.</p>
<b>National Prefix / City Code</b>	<p>Enter the national prefix and the area code for the location where your system is installed. With a point-to-point ISDN access, this area code is essential, because otherwise e. g. no automatic external callback is possible.</p>

The menu **Advanced Settings** consists of the following fields:

#### Fields in the menu **Charge Settings**

Field	Value
<b>Charge Rate Factor</b>	Enter the factor for the connection costs.  The default value is <i>0.00</i> .
<b>Currency</b>	Here, enter the name of the currency, e. g. <i>EUR</i> , (max. three characters). This entry is just a name which is not involved in any calculation of the tariff unit factor. Special characters are not permitted.
<b>Charge Information (S0 / Upn Extension)</b>	Select the transmission method for charge information on the internal S0 bus.  Possible values: <ul style="list-style-type: none"> <li>• <i>Keypad</i>: Depending on country and provider, the charging information is transmitted so as to allow direct display by the terminal.</li> <li>• <i>Functional</i>: The charge information is transmitted in binary, coded form, and the terminal first needs to decode it (EURO ISDN).</li> <li>• <i>Both</i> (default value): Both protocols are recognised.</li> </ul>

#### Fields in the menu **Day Mode**

Field	Value
<b>Global Rerouting</b>	Select the call variant in day modus that shall apply to the overall system if no specific redirect has been set up.  The default value is <i>Variant 1</i> .

### Night operation

You can switch the system to night operation and thus enable particular call variants for the team signalling, the door intercom signalling and the rejection functions.

An advanced switching of the call variants is possible via a code or the calendar that has been configured for night operation. You configure a calendar for night operation in the **Applications->Calendar->Calendar->New** menu.

#### Fields in the menu **Night Mode**

Field	Value
<b>Team Signalling</b>	Select the call variants for team signalling in night operation.

Field	Value
	The default value is <i>Variant 1</i> .
<b>Doorcom Signalling</b>	Select the door intercom variants for door intercom signalling in night operation.  The default value is <i>Variant 1</i> .
<b>Rerouting of Incoming Distribution</b>	Select the call variants for reject to message in night operation.  The default value is <i>Variant 1</i> .
<b>Extension Rerouting</b>	Select the call variants for reject to direct dial-in in night operation.  The default value is <i>Variant 1</i> .
<b>Global Rerouting</b>	Select the call variants for general rejection in night operation.  The default value is <i>Variant 1</i> .
<b>Alarm Input</b>	Select the call variants for alarm in night operation.  The default value is <i>Variant 1</i> .

## 7.2.2 Passwords

Setting the passwords is another basic system setting.



### Note

All bintec elmegbintec elmeg devices are delivered with the same username and password and the same PINs. As long as the passwords or PINs remain unchanged, they are not protected against unauthorised use.

When you log onto your device for the first time, you are prompted to change the password. You need to change the system administrator password in order to be able to configure your device.

Make sure you change all passwords and PIN's to prevent unauthorised access to the device.

The **System Management->Global Settings->Passwords** menu consists of the following

fields:

#### Fields in the System Password menu.

Field	Value
<b>System Admin Password</b>	<p>Enter the password for the user name <i>admin</i>.</p> <p>The default password is <i>admin</i>.</p> <p>This password is also used with SNMPv3 for authentication (MD5) and encryption (DES).</p>
<b>Confirm Admin Password</b>	<p>Confirm the password by entering it again.</p>

#### PIN1 and PIN2

You can use various protection functions to prevent misuse of your system. Your system settings protect you by means of a 4-digit PIN1 (pin number). Access from outside (remote access) is protected by a 6-character PIN2.

PIN1 is a 4-digit pin number that allows you to protect system settings from unauthorised access. PIN2 is a 6-digit pin number that prevents unauthorised external subscribers from being able to use your system. These functions can only be used after entering a 6-digit PIN2.

Various settings are protected by the system's PIN1. In the basic setting, the PIN1 is set to *none*.

The following performance features are protected using PIN2:

- Remote access for Follow me, room monitoring

#### Fields in the Configuration via Phone (4-Digit Numeric PIN) menu.

Field	Value
<b>PIN1</b>	<p>Enter PIN1.</p> <p>The default value is <i>none</i>.</p> <p>With the 4-digit PIN1 (PIN number) you protect your system settings through configuration via telephone.</p>

#### Fields in the Remote Access to Phone (6-Digit Numeric PIN) menu.

Field	Value
<b>Remote Access (e.g.</b>	Select whether a remote access of your system is to be permit-



Field	Value
<b>Follow me, Room Monitoring)</b>	<p>ted.</p> <p>The function is activated with <i>Enabled</i>.</p> <p>The function is disabled by default.</p>
<b>PIN2</b>	<p>Only if <b>Remote Access (e.g. Follow me, Room Monitoring)</b> is enabled.</p> <p>Enter the <b>PIN2</b>.</p> <p>The default value is <i>000000</i>.</p> <p>Through the 6-digit <b>PIN2</b> you protect from external access (remote access).</p>

#### Fields in the **SNMP Communities** menu.

Field	Value
<b>SNMP Read Community</b>	<p>Enter the password for the user name <i>read</i>.</p> <p>The default password is <i>admin</i>.</p>
<b>SNMP Write Community</b>	<p>Enter the password for the user name <i>write</i>.</p> <p>The default password is <i>admin</i>.</p>

#### Field in the **Global Password Options** menu

Field	Value
<b>Show passwords and keys in clear text</b>	<p>Define whether the passwords are to be displayed in clear text (plain text).</p> <p>The function is enabled with <i>Show</i></p> <p>The function is disabled by default.</p> <p>If you activate the function, all passwords and keys in all menus are displayed and can be edited in plain text.</p> <p>One exception is IPSec keys. They can only be entered in plain text. After pressing <b>OK</b> or calling the menu again, they are displayed as asterisks.</p>

## 7.2.3 Date and Time

You need the system time for tasks such as correct time-stamps for system messages, or accounting.

You have the following options for determining the system time (local time):

### ISDN/Manual

The system time can be updated via ISDN, i.e. with every existing external connection the date and time are taken from the ISDN. The date and time can also be entered manually, e. g. if time and date are not sent in the ISDN or no time server is provided. The time remains for approx. 3 hours after the system's power supply is switched off.

The clock switches from summer to winter time (and back) automatically. This is independent of the exchange time or the ntp server time. Summer time starts on the last Sunday in March by switching from 2 a.m. to 3 a.m. The calendar-related or schedule-related switches that are scheduled for the missing hour are then carried out. Winter time starts on the last Sunday in October by switching from 3 a.m. to 2 a.m. The calendar-related or schedule-related switches that are scheduled for the additional hour are then carried out.

### Time server

You can obtain the system time automatically, e.g. using various time servers. To ensure that the device uses the desired current time, you should configure one or more time servers.



#### Note

If a method for automatically deriving the time is defined on the device, the values obtained in this way automatically have higher priority. A manually entered system time is therefore overwritten.

The menu **System Management->Global Settings->Date and Time** consists of the following fields:

#### Fields in the **Basic Settings** menu.

Field	Description
<b>Time Zone</b>	Select the time zone in which your device is installed.  You can select Universal Time Coordinated (UTC) plus or

Field	Description
	minus the deviation in hours or a predefined location.  compact systems: The default value is <i>Europe/Berlin</i> .
<b>Current Local Time</b>	The current date and current system time are shown here. The entry cannot be changed.

#### Fields in the **Manual Time Settings** menu.

Field	Description
<b>Set Date</b>	Enter a new date.  Format: <ul style="list-style-type: none"> <li>• <b>Day:</b> dd</li> <li>• <b>Month:</b> mm</li> <li>• <b>Year:</b> yyyy</li> </ul>
<b>Set Time</b>	Enter a new time.  Format: <ul style="list-style-type: none"> <li>• <b>Hour:</b> hh</li> <li>• <b>Minute:</b> mm</li> </ul>

#### Fields in the **Automatic Time Settings (Time Protocol)** menu.

Field	Description
<b>ISDN Timeserver</b>	Determine whether the system time is to be updated via ISDN.  If a time server is configured, the time is only determined over ISDN until a successful update is received from this time server. Updating over ISDN is deactivated for the period in which the time is determined by means of a time server.  The function is activated with <i>Enabled</i> .  The function is enabled by default.
<b>First Timeserver</b>	Enter the primary time server, by using either a domain name or an IP address.  In addition, select the protocol for the time server request.

Field	Description
	<p>Possible values:</p> <ul style="list-style-type: none"> <li>• <i>SNTP</i> (default value): This server uses the simple network time protocol via UDP port 123.</li> <li>• <i>Time Service / UDP</i>: This server uses the Time service with UDP port 37.</li> <li>• <i>Time Service / TCP</i>: This server uses the Time service with TCP port 37.</li> <li>• <i>None</i>: This time server is not currently used for the time request.</li> </ul>
<b>Second Timeserver</b>	<p>Enter the secondary time server, by using either a domain name or an IP address.</p> <p>In addition, select the protocol for the time server request.</p> <p>Possible values:</p> <ul style="list-style-type: none"> <li>• <i>SNTP</i> (default value): This server uses the simple network time protocol via UDP port 123.</li> <li>• <i>Time Service / UDP</i>: This server uses the Time service with UDP port 37.</li> <li>• <i>Time Service / TCP</i>: This server uses the Time service with TCP port 37.</li> <li>• <i>None</i>: This time server is not currently used for the time request.</li> </ul>
<b>Third Timeserver</b>	<p>Enter the third time server, by using either a domain name or an IP address.</p> <p>In addition, select the protocol for the time server request.</p> <p>Possible values:</p> <ul style="list-style-type: none"> <li>• <i>SNTP</i> (default value): This server uses the simple network time protocol via UDP port 123.</li> <li>• <i>Time Service / UDP</i>: This server uses the Time service with UDP port 37.</li> <li>• <i>Time Service / TCP</i>: This server uses the Time service with TCP port 37.</li> <li>• <i>None</i>: This time server is not currently used for the time request.</li> </ul>

Field	Description
<b>Time Update Interval</b>	<p>Enter the time interval in minutes at which the time is automatically updated.</p> <p>The default value is <i>1440</i>.</p>
<b>Time Update Policy</b>	<p>Enter the time period after which the system attempts to contact the time server again following a failed time update.</p> <p>Possible values:</p> <ul style="list-style-type: none"> <li>• <i>Normal</i> (default value): The system attempts to contact the time server after 1, 2, 4, 8, and 16 minutes.</li> <li>• <i>Aggressive</i>: For ten minutes, the system attempts to contact the time server after 1, 2, 4, 8 seconds and then every 10 seconds.</li> <li>• <i>Endless</i>: For an unlimited period, the system attempts to contact the time server after 1, 2, 4, 8 seconds and then every 10 seconds.</li> </ul> <p>If certificates are used to encrypt data traffic in a VPN, it is extremely important that the correct time is set on the device. To ensure this is the case, for <b>Time Update Policy</b>, select the value <i>Endless</i>.</p>
<b>Internal Time Server</b>	<p>Select whether the internal timeserver is to be used.</p> <p>The function is activated by selecting <i>Enabled</i>. Time requests from a client will be answered with the current system time. This is given as GMT, without offset.</p> <p>The function is enabled by default. Clients' time requests are answered in the LAN.</p>

## 7.2.4 Timer

In the **Timer** menu you can configure the times at which particular system features are to be switched on by default.

The menu **System Management->Global Settings->Timer** consists of the following fields:

**Fields in the Basic Settings menu.**

Field	Description
<b>Call Forwarding (CFNR)</b>	<p>Enter the time in seconds after which a <b>Call Forwarding (CFNR)</b> will be executed.</p> <p>Possible values are <i>1</i> to <i>99</i>.</p> <p>The default value is <i>15</i>.</p>
<b>Direct Call</b>	<p>Enter the time in seconds after which the configured number will be dialled when the receiver is lifted.</p> <p>You wish to set up a telephone for which the connection to a specific number is established without entering the number (e.g. emergency telephone). You are not at home. However, there is someone at home who needs to be able to reach you quickly and easily by telephone if necessary (e. g. children or grandparents). If you have set up the "Direct Call" function for one or more telephones, the receiver of the corresponding telephone only needs to be lifted. After a time period without further entries set in configuration, the system automatically dials the configured direct call number.</p> <p>If you do not dial within the specified period from picking up the receiver, automatic dialling is initiated.</p> <p>Possible values are <i>1</i> to <i>30</i>.</p> <p>The default value is <i>5</i>.</p>
<b>External Door Connections</b>	<p>If an external telephone requests a door intercom call, here you can set the time in seconds after which this call is forcefully terminated.</p> <p>Possible values:</p> <ul style="list-style-type: none"> <li>• <i>infinite</i></li> <li>• <i>60 seconds</i></li> <li>• <i>120 seconds</i></li> <li>• <i>180 seconds</i> (default value)</li> <li>• <i>240 seconds</i></li> <li>• <i>300 seconds</i></li> </ul>

Fields in the **Advanced Settings** menu.

Field	Value
<b>Explicit Call Transfer</b>	<p>Enter the time in seconds after which the initiating subscriber is to be called back or hear call waiting if the required subscriber could not be reached.</p> <p>You have passed a caller to another subscriber by brokering or transfer. This subscriber cannot be reached or is engaged. But you wish to prevent the subscriber terminating the call or being diverted by the system after a time. You achieve this using an automatic callback to your telephone. In the case of calls which are transferred with no message (special call transfer, UbA), a callback or call waiting (if there is already a new call) is made to the initiating subscriber after the time entered here.</p> <p>Possible values are <i>10</i> to <i>179</i>.</p> <p>The default value is <i>30</i>.</p>
<b>Transfer to busy extension</b>	<p>Enter the time in seconds after which a subscriber in the waiting loop is reconnected with the switchboard.</p> <p>The switchboard wishes to pass a call to a particular employee. However, this person is currently on the phone. The call can then be switched to the subscriber's waiting loop. If the call is not taken in the time entered here, the switchboard is called again.</p> <p>Possible values are <i>10</i> to <i>600</i>.</p> <p>The default value is <i>30</i>.</p>
<b>System Parking (Open Enquiry)</b>	<p>Enter the time in seconds after which an open hold for enquiry is terminated and the subscriber called back or given a call waiting.</p> <p>You are making a call and want to transfer it to a colleague. Unfortunately, you do not know where this colleague is. <b>System Parking (Open Enquiry)</b> holds the caller in the system's queue. You can now make an announcement from your telephone to notify your colleague that the call is waiting. Using a code for the open hold for enquiry, the colleague can take the call on any telephone.</p> <p>If a call waiting in the queue is not taken by a subscriber within the time entered here, the initiating subscriber is called back or</p>

Field	Value
	given a call waiting.
	Possible values are 10 to 600.
	The default value is 30.

## 7.2.5 System Licences

This chapter describes how to activate the functions of the software licences you have purchased.

The following licence types exist:

- Licences already available in the device's ex works state
- Free extra licences
- Extra licences at additional cost

The data sheet for your device tells you which licences are available in the device's ex works state and which can also be obtained free of charge or at additional cost. You can access this data sheet at [www.bintec-elmeg.com](http://www.bintec-elmeg.com).

### Entering licence data

You can obtain the licence data for extra licences via the online licensing pages in the support section at [www.bintec-elmeg.com](http://www.bintec-elmeg.com). Please follow the online licensing instructions. (Please also note the information on the licence card for licences at additional cost.) You will then receive an e-mail containing the following data:

- **Licence Key** and
- **Licence Serial Number**.

You enter this data in the **System Management->Global Settings->System Licences->New** menu.

In the **System Management->Global Settings->System Licences->New** menu, a list of all registered licences is displayed (**Description**, **Licence Type**, **Licence Serial Number**, **Status**).

#### Possible values for Status

Licence	Meaning
OK	Subsystem is activated.
Not OK	Subsystem is not activated.



Licence	Meaning
Not supported	You have entered a licence for a subsystem your device does not support.

In addition, above the list is shown the **System Licence ID** required for online licensing.



#### Note

To restore the standard licences for a device, click the **Default Licences** button (standard licences).

### 7.2.5.1 Edit or New

Choose the  icon to edit existing entries. Choose the **New** button to enter more licences.

#### Activating extra licences

You activate extra licences by adding the received licence information in the **System Management->Global Settings->System Licences->New** menu.

The menu **System Management->Global Settings->System Licences->New** consists of the following fields:

#### Fields in the Basic Settings menu.

Field	Value
<b>Licence Serial Number</b>	Enter the licence serial number you received when you bought the licence.
<b>Licence Key</b>	Enter the licence key you received by e-mail.



#### Note

If *Not OK* is displayed as the status:

- Enter the licence data again.
- Check your hardware serial number.

If *Not Supported* is displayed as the status, you have entered a license for a subsystem that your device does not support. This means you cannot use the functions of this licence.

### Deactivating a licence

Proceed as follows to deactivate a licence:

- (1) Go to **System Management->Global Settings->System Licences->New**.
- (2) Press the  icon in the line containing the licence you want to delete.
- (3) Confirm with **OK**.

The licence is deactivated. You can reactivate your additional licence at any time by entering the valid licence key and licence serial number.

## 7.3 Access Codes

In your day-to-day work you have employed codes to use particular features and you wish to use them again with your new system. However, other codes are set for these features in the basic setting. No problem - you can change the codes for different features. So you can use your usual codes for these features in the future.

### 7.3.1 Alternative Access Codes

You use the **Alternative Access Codes** menu to configure the system's access number plan.

The access number can be set individually for some performance features in the system configuration. The access number preset in the system is supplemented with a call number from the system's internal number plan. For performance features **Open inquiry** and **Bundles**, several access codes can be assigned. The performance feature with modified access number is operated as described for the corresponding performance feature. You can use the modified access number (internal number) or the access number described in the user guide (excluding dialling code).

The **System Management->Access Codes->Alternative Access Codes** menu consists of the following fields:

#### Fields in the Basic Settings menu.

Field	Description
<b>Line Access Digit</b>	Select the exchange code.  Possible values: <ul style="list-style-type: none"> <li>• <i>None</i></li> <li>• <i>0</i> (default value)</li> </ul>

Field	Description
	<ul style="list-style-type: none"> <li>• 6</li> <li>• 7</li> <li>• 8</li> <li>• 9</li> </ul>
<b>Pick-up Group</b>	Enter the new code for performance feature <b>Pick-up (group)</b> .
<b>Pick-up (Extension)</b>	Enter the new code for performance feature <b>Pick-up (internal subscriber)</b> .
<b>Assign project codes</b>	Enter the new code for performance feature <b>Assign project codes</b> .
<b>Speed Dial</b>	Enter the new code for performance feature <b>Speed Dial</b> .
<b>Trunk Group Selection</b>	<p>Create the new access numbers for the <b>Trunk Group Selection</b> feature.</p> <p>To do this, first click <b>Add</b> to create a bundle selection, select the bundle and enter the access number you require for the bundle.</p>
<b>System Parking (Open Enquiry)</b>	<p>Create the new access numbers for the <b>System Parking (Open Enquiry)</b> feature.</p> <p>To do this, first click <b>Add</b> to create a queue in which the caller is to be held, and enter the access number you require for the queue. You can create a maximum of 10 entries.</p>

## 7.4 Interface Mode / Bridge Groups

In this menu, you define the operation mode for your device's interfaces.

### Routing versus bridging

Bridging connects networks of the same type. In contrast to routing, bridges operate at layer 2 of the OSI model (data link layer), are independent of higher-level protocols and transmit data packets using MAC addresses. Data transmission is transparent, which means the information contained in the data packets is not interpreted.

With routing, different networks are connected at layer 3 (network layer) of the OSI model

and information is routed from one network to the other.

## Conventions for port/interface names

If your device has a radio port, it receives the interface name WLAN. If there are several radio modules, the names of wireless ports in the user interface of your device are made up of the following parts:

- (a) WLAN
- (b) Number of the physical port (1 or 2)

Example: *WLAN1* The name of the Ethernet port is made up of the following parts:

- (a) ETH
- (b) Number of the port

Example: *ETH1*

The name of the interface connected to an Ethernet port is made up of the following parts:

- (a) Abbreviation for interface type, whereby *en* stands for internet.
- (b) Number of the Ethernet port
- (c) Number of the interface

Example: *en1-0* (first interface on the first Ethernet port)

The name of the bridge group is made up of the following parts:

- (a) Abbreviation for interface type, whereby *br* stands for bridge group.
- (b) Number of the bridge group

Example: *br0* (first bridge group)

The name of the wireless network (VSS) is made up of the following parts:

Abbreviation for interface type, whereby *vss* stands for wireless network.

- (a) Number of the wireless module
- (b) Number of the interface

Example: *vss1-0* (first wireless network on the first wireless module)

The name of the bridge link is made up of the following parts:

- (a) Abbreviation for interface type
- (b) Number of the wireless module on which the bridge link is configured

(c) Number of the bridge link

Example: *wds1-0* (first bridge link on the first wireless module)

The name of the client link is made up of the following parts:

- (a) Abbreviation for interface type
- (b) Number of the wireless module on which the client link is configured
- (c) Number of the client link

Example: *sta1-0* (first client link on the first wireless module)

The name of the virtual interface connected to an Ethernet port is made up of the following parts:

- (a) Abbreviation for interface type
- (b) Number of the Ethernet port
- (c) Number of the interface connected to the Ethernet port
- (d) Number of the virtual interface

Example: *en1-0-1* (first virtual interface based on the first interface on the first Ethernet port)

## 7.4.1 Interfaces

You define separately whether each interface is to operate in routing or bridging mode.

If you want to set bridging mode, you can either use existing bridge groups or create a new bridge group.

The default setting for all existing interfaces is routing mode. When selecting the option *New Bridge Group* for **Mode / Bridge Group**, a bridge group, i.e. *br0, br1* etc. is automatically created and the interface is run in bridging mode.

The **System Management->Interface Mode / Bridge Groups->Interfaces** menu consists of the following fields:

### Fields in the Interfaces menu.

Field	Description
<b>Interface Description</b>	Displays the name of the interface.
<b>Mode / Bridge Group</b>	Select whether you want to run the interface in <i>Routing Mode</i> or whether you want to assign the interface to an existing ( <i>br0, br1</i> etc.) or new bridge group ( <i>New Bridge Group</i> ).

Field	Description
	When selecting <i>New Bridge Group</i> , a new bridge group is automatically created after you click the <b>OK</b> button.
<b>Configuration Interface</b>	<p>Select the interface via which the configuration is to be carried out.</p> <p>Possible values:</p> <ul style="list-style-type: none"> <li>• <i>Select one</i> (default value): Ex works setting The right configuration interface must be selected from the other options.</li> <li>• <i>Ignore</i>: No interface is defined as configuration interface.</li> <li>• <i>&lt;Interface name&gt;</i>: Select the interface to be used for configuration. If this interface is in a bridge group, it is assigned the group's IP address when it is taken out of the group.</li> </ul>

#### 7.4.1.1 Add

Choose the **Add** button to edit the mode of PPP interfaces.

The **System Management->Interface Mode / Bridge Groups->Interfaces->Add** menu consists of the following fields:

##### Fields in the Interfaces menu.

Field	Description
<b>Interface</b>	Select the interface whose status should be changed.

#### Edit for devices the Wlxxxxn and RS series

For WLAN clients in bridge mode (so-called MAC Bridge) you can also edit additional settings via the  icon.

You can realise bridging for devices behind access clients with the MAC Bridge function. In wildcard mode you cannot define how Unicast non-IP frames or non-ARP frames are processed. To use the MAC bridge function, you must carry out configuration steps in several menus.

- (1) Select **GUI** menu **Wireless LAN->WLAN->Radio Settings** and click the icon to modify an entry.
- (2) Select **Operation Mode** = *Access Client* and save the settings with **OK**.
- (3) Select the **System Management->Interface Mode / Bridge Groups->Interfaces** menu. The additional interface **sta1-0** is displayed.

- (4) For interface **sta1-0** select Mode / Bridge Group = *br0* (<IPAddress>) and **Configuration Interface**= *en1-0* and save the settings with **OK**.
- (5) Click the **Save configuration** button to save all of the configuration settings. You can use the MAC Bridge.

The **System Management->Interface Mode / Bridge Groups->Interfaces->**  menu consists of the following fields:

#### Fields in the Layer-2.5 Options menu.

Field	Value
<b>Interface</b>	Shows the interface that is being edited.
<b>Wildcard Mode</b>	<p>Select the Wildcard mode you want to use on the interface.</p> <p>Possible values:</p> <ul style="list-style-type: none"> <li>• <i>none</i> (default value): Wildcard mode is not used.</li> <li>• <i>static</i>: With this setting, you must enter the MAC address of a device that is connected over IP under <b>Wildcard MAC Address</b>. Each packet without IP and without ARP is forwarded to this device. This occurs even when the device is no longer connected.</li> <li>• <i>first</i>: If you choose this setting, the MAC address of the first non-IP unicast frame or non-ARP unicast frame, which occurs on any of the Ethernet interfaces, is used as the wildcard MAC address. This wildcard MAC address can only be reset by rebooting the device or by selecting another wildcard mode.</li> <li>• <i>last</i>: If you choose this setting, the internal WLAN MAC address is used to establish a connection to the access point. As soon as a non-IP unicast frame or non-ARP unicast frame appears, it is forwarded to the MAC address from which the last non-IP unicast frame or non-ARP unicast frame was received on the Ethernet interface of the device. This wildcard MAC address is renewed with each non-IP unicast frame or non-ARP unicast frame.</li> </ul>
<b>Wildcard MAC Address</b>	<p>Only for <b>Wildcard Mode</b> = <i>static</i></p> <p>Enter the MAC address of a device that is connected over IP.</p>
<b>Transparent MAC Address</b>	<p>Only for <b>Wildcard Mode</b> = <i>static, first</i></p> <p>Choose whether or not the <b>Wildcard MAC Address</b> are used in</p>

Field	Value
	addition as WLAN MAC address to establish the connection to the access point.
	The function is enabled with <i>Enabled</i> .
	The function is disabled by default.

## 7.5 Administrative Access

In this menu, you can configure the administrative access to the device.

### 7.5.1 Access

In the **System Management->Administrative Access->Access** menu, a list of all IP-capable interfaces is displayed.

For an Ethernet interface you can select the access parameters *Telnet, SSH, HTTP, HTTPS, Ping, SNMP* and for the ISDN interfaces *ISDN Login*.



#### Note

Not all of the options above will be available in every bintec elmeg device. Consult the data sheet of your device which connection types are supported!

For PABX systems only: You can also authorise your device for maintenance work from bintec elmeg's Customer Service department. To do this you enable either **Service Login (ISDN Web-Access)** or **Service Call Ticket (SSH Web Access)**, depending on the service you require, and select the **OK** button. Follow the instructions given by Telekom's Customer Service!

**Service Login (ISDN Web-Access)** is disabled by default.

The menu **Advanced Settings** consists of the following fields:

#### Fields in the menu **Advanced Settings**

Field	Description
<b>Restore Default Settings</b>	Only when you make changes to the administrative access configuration are relevant access rules set up and activated. You can restore the default settings with the  icon.



### 7.5.1.1 Add

Select the **Add** button to configure administrative access for additional interfaces.

The **System Management->Administrative Access->Access->Add** menu consists of the following fields:

#### Fields in the menu Access

Field	Description
<b>Interface</b>	Select the interface for which administrative access is to be configured.

### 7.5.2 SSH

Your devices offers encrypted access to the shell. You can enable or disable this access in the **System Management->Administrative Access->SSH Enabled** menu (standard value). You can also access the options for configuring the SSH login.

You need an SSH client application, e.g. PuTTY, to be able to reach the SSH Daemon.

If you wish to use SSH Login together with the PuTTY client, you may need to comply with some special configuration requirements, for which we have prepared FAQs. You will find these in the Service/Support section at [www.bintec-elmeg.com](http://www.bintec-elmeg.com).

To be able to reach the shell of your device via an SSH client, make sure the settings for the SSH Daemon and SSH client are the same.



#### Note

If configuration of an SSH connection is not possible, restart the device to initialise the SSH Daemon correctly.

The **System Management->Administrative Access->SSH** menu consists of the following fields:

#### Fields in the menu SSH (Secure Shell) Parameters

Field	Value
<b>SSH service active</b>	Select whether the SSH Daemon is to be enabled for the interface.

Field	Value
	<p>The function is activated by selecting <i>Enabled</i>.</p> <p>The function is enabled by default.</p>
<b>SSH Port</b>	<p>Here you can enter the port via which the SSH connection is to be established.</p> <p>The default value is <i>22</i>.</p>
<b>Maximum number of concurrent connections</b>	<p>Enter the maximum number of simultaneously active SSH connections.</p> <p>The default value is <i>1</i>.</p>

#### Fields in the menu Authentication and Encryption Parameters

Field	Value
<b>Encryption Algorithms</b>	<p>Select the algorithms that are to be used to encrypt the SSH connection.</p> <p>Possible options:</p> <ul style="list-style-type: none"> <li>• <i>3DES</i></li> <li>• <i>Blowfish</i></li> <li>• <i>AES-128</i></li> <li>• <i>AES-256</i></li> </ul> <p>By default <i>3DES</i>, <i>Blowfish</i> and <i>AES-128</i> are enabled.</p>
<b>Hashing Algorithms</b>	<p>Select the algorithms that are to be available for message authentication of the SSH connection.</p> <p>Possible options:</p> <ul style="list-style-type: none"> <li>• <i>MD5</i></li> <li>• <i>SHA-1</i></li> <li>• <i>RipeMD 160</i></li> </ul> <p>By default <i>MD5</i>, <i>SHA-1</i> and <i>RipeMD 160</i> are enabled.</p>

#### Fields in the menu Key Status

Field	Value
<b>RSA Key Status</b>	<p>Shows the status of the RSA key.</p> <p>If an RSA key has not been generated yet, <i>Not generated</i> is displayed in red and a link, <i>Generate</i>, is provided. If you select the link, the generation process is triggered and the view is updated. The <i>Generating</i> status is displayed in green. When generation has been completed successfully, the status changes from <i>Generating</i> to <i>Generated</i>. If an error occurs during the generation, <i>Not generated</i> and the <i>Generate</i> link are displayed again. You can then repeat generation.</p> <p>If the <i>Unknown</i> status is displayed, generation of a key is not possible, for example because there is not enough space in the FlashROM.</p> <p>The status is <i>Not generated</i> by default.</p>
<b>DSA Key Status</b>	<p>Shows the status of the DSA key.</p> <p>If no DSA key has yet been generated, <i>Not generated</i> is displayed in red and a link, <i>Generate</i>, is provided. If you select the link, the generation process is triggered and the view is updated. The <i>Generating</i> status is displayed in green. When generation has been completed successfully, the status changes from <i>Generating</i> to <i>Generated</i>. If an error occurs during the generation, <i>Not generated</i> and the <i>Generate</i> link are displayed again. You can then repeat generation.</p> <p>If the <i>Unknown</i> status is displayed, generation of a key is not possible, for example because there is not enough space in the FlashROM.</p> <p>The status is <i>Not generated</i> by default.</p>

The menu **Advanced Settings** consists of the following fields:

#### Fields in the menu **Advanced Settings**

Field	Value
<b>Login Grace Time</b>	<p>Enter the time (in seconds) that is available for establishing the connection. If a client cannot be successfully authenticated during this time, the connection is terminated.</p> <p>The default value is <i>600</i> seconds.</p>

Field	Value
<b>Compression</b>	<p>Select whether data compression should be used.</p> <p>The function is activated by selecting <i>Enabled</i>.</p> <p>The function is disabled by default.</p>
<b>TCP Keepalives</b>	<p>Select whether the device is to send keepalive packets.</p> <p>The function is activated by selecting <i>Enabled</i>.</p> <p>The function is enabled by default.</p>
<b>Logging Level</b>	<p>Select the syslog level for the syslog messages generated by the SSH Daemon.</p> <p>Possible settings:</p> <ul style="list-style-type: none"> <li>• <i>Information</i> (default value): Fatal and simple errors of the SSH Daemon and information messages are recorded.</li> <li>• <i>Fatal</i>: Only fatal errors of the SSH Daemon are recorded.</li> <li>• <i>Error</i>: Fatal and simple errors of the SSH Daemon are recorded.</li> <li>• <i>Debug</i>: All messages are recorded.</li> </ul>

### 7.5.3 SNMP

SNMP (Simple Network Management Protocol) is a network protocol used to monitor and control network elements (e.g. routers, servers, switches, printers, computers etc.) from a central station. SNMP controls communication between the monitored devices and monitoring station. The protocol describes the structure of the data packets that can be transmitted, as well as the communication process.

The data objects queried via SNMP are structured in tables and variables and defined in the MIB (Management Information Base). This contains all the configuration and status variables of the device.

SNMP can be used to perform the following network management tasks:

- Surveillance of network components
- Remote controlling and configuration of network components
- Error detection and notification

You use this menu to configure the use of SNMP.

The menu **System Management->Administrative Access->SNMP** consists of the following fields:

#### Fields in the **Basic Settings** menu.

Field	Value
<b>SNMP Version</b>	<p>Select the SNMP version your device is to use to listen for external SNMP access.</p> <p>Possible values:</p> <ul style="list-style-type: none"> <li>• <i>v1</i>: SNMP Version 1</li> <li>• <i>v2c</i>: Community-Based SNMP Version 2</li> <li>• <i>v3</i>: SNMP Version 3</li> </ul> <p>By default, <i>v1</i>, <i>v2c</i> and <i>v3</i> are enabled.</p> <p>If no option is selected, the function is deactivated.</p>
<b>SNMP Listen UDP Port</b>	<p>Shows the UDP port ( <i>161</i> ) at which the device receives SNMP requests.</p> <p>The value cannot be changed.</p>
<b>SNMP multicast discovery</b>	<p>Enable or disable the function <b>SNMP multicast discovery</b>.</p> <p>The function is enabled with <i>Enabled</i>.</p> <p>The function is enabled by default.</p>



#### Tip

If your SNMP Manager supports SNMPv3, you should, if possible, use this version as older versions transfer all data unencrypted.

## 7.6 Remote Authentication

This menu contains the settings for user authentication.

## 7.6.1 RADIUS

RADIUS (Remote Authentication Dial In User Service) is a service that enables authentication and configuration information to be exchanged between your device and a RADIUS server. The RADIUS server administrates a database with information about user authentication and configuration and for statistical recording of connection data.

RADIUS can be used for:

- Authentication
- Accounting
- Exchange of configuration data

For an incoming connection, your device sends a request with user name and password to the RADIUS server, which then searches its database. If the user is found and can be authenticated, the RADIUS server sends corresponding confirmation to your device. This confirmation also contains parameters (called RADIUS attributes), which your device uses as WAN connection parameters.

If the RADIUS server is used for accounting, your device sends an accounting message at the start of the connection and a message at the end of the connection. These start and end messages also contain statistical information about the connection (IP address, user name, throughput, costs).

### RADIUS packets

The following types of packets are sent between the RADIUS server and your device (client):

#### Packet types

Field	Value
ACCESS_REQUEST	Client -> Server  If an access request is received by your device, a request is sent to the RADIUS server if no corresponding connection partner has been found on your device.
ACCESS_ACCEPT	Server -> Client  If the RADIUS server has authenticated the information contained in the ACCESS_REQUEST, it sends an ACCESS_ACCEPT to your device together with the parameters used for setting up the connection.

Field	Value
ACCESS_REJECT	Server -> Client  If the information contained in the ACCESS_REQUEST does not correspond to the information in the user database of the RADIUS server, it sends an ACCESS_REJECT to reject the connection.
ACCOUNTING_START	Client -> Server  If a RADIUS server is used for accounting, your device sends an accounting message to the RADIUS server at the start of each connection.
ACCOUNTING_STOP	Client -> Server  If a RADIUS server is used for accounting, your device sends an accounting message to the RADIUS server at the end of each connection.

A list of all entered RADIUS servers is displayed in the **System Management->Remote Authentication->RADIUS** menu.

### 7.6.1.1 Edit or New

Choose the  icon to edit existing entries. Choose the **New** button to add RADIUS servers.

The **System Management->Remote Authentication->RADIUS->New** menu consists of the following fields:

#### Fields in the Basic Parameters menu.

Field	Value
<b>Authentication Type</b>	Select what the RADIUS server is to be used for.  Possible values: <ul style="list-style-type: none"> <li>• <i>PPP Authentication</i> (default value only for PPP connections): The RADIUS server is used for controlling access to a network.</li> <li>• <i>Accounting</i> (for PPP connections only): The RADIUS server is used for recording statistical call data.</li> </ul>

Field	Value
	<ul style="list-style-type: none"> <li>• <i>Login Authentication</i>: The RADIUS server is used for controlling access to the SNMP shell of your device.</li> <li>• <i>IPSec Authentication</i>: The RADIUS server is used for sending configuration data for IPSec peers to your device.</li> <li>• <i>WLAN (802.1x)</i>: The RADIUS server is used for controlling access to a wireless network.</li> <li>• <i>XAUTH</i>: The RADIUS server is used for authenticating IPSec peers via XAuth.</li> </ul>
<b>Vendor Mode</b>	<p>Only for <b>Authentication Type</b> = <i>Accounting</i></p> <p>In hotspot applications, select the mode define by the provider.</p> <p>In standard applications, leave the value set to <i>Default</i>.</p> <p>Possible values for hotspot applications:</p> <ul style="list-style-type: none"> <li>• <i>France Telecom</i>: For France Telecom hotspot applications.</li> <li>• <i>bintec HotSpot Server</i>: For hotspot applications.</li> </ul>
<b>Server IP Address</b>	Enter the IP address of the RADIUS server.
<b>RADIUS Secret</b>	Enter the shared password used for communication between the RADIUS server and your device.
<b>Default User Password</b>	Some Radius servers require a user password for each RADIUS request. Enter the password that your device sends as the default user password in the prompt for the dialout routes on the RADIUS server.
<b>Priority</b>	<p>If a number of RADIUS server entries were created, the server with the highest priority is used first. If this server does not answer, the server with the next-highest priority is used.</p> <p>Possible values from 0 (highest priority) to 7 (lowest priority).</p> <p>The default value is 0.</p> <p>See also <b>Policy</b> in the Advanced Settings.</p>
<b>Entry active</b>	<p>Select whether the RADIUS server configured in this entry is to be used.</p> <p>The function is activated by selecting <i>Enabled</i>.</p>



Field	Value
	The function is enabled by default.
<b>Group Description</b>	<p>Define a new RADIUS group description or assign the new RADIUS entry to a predefined group. The configured RADIUS servers for a group are queried according to <b>Priority</b> and the <b>Policy</b> .</p> <p>Possible values:</p> <ul style="list-style-type: none"> <li>• <i>New</i> (default value): Enter a new group description in the text field.</li> <li>• <i>Default Group 0</i>: Select this entry for special applications, such as Hotspot Server configuration.</li> <li>• <i>&lt;Group Name&gt;</i>: Select a predefined group from the list.</li> </ul>

The **Advanced Settings** menu consists of the following fields:

#### Fields in the **Advanced Settings** menu.

Field	Value
<b>Policy</b>	<p>Select how your device is to react if a negative response to a request is received.</p> <p>Possible values:</p> <ul style="list-style-type: none"> <li>• <i>Authoritative</i> (default value): A negative response to a request is accepted.</li> <li>• <i>Non-authoritative</i> : A negative response to a request is not accepted. A request is sent to the next RADIUS server until your device receives a response from a server configured as authoritative.</li> </ul>
<b>UDP Port</b>	<p>Enter the UDP port to be used for RADIUS data.</p> <p>RFC 2138 defines the default ports 1812 for authentication (1645 in older RFCs) and 1813 for accounting (1646 in older RFCs). You can obtain the port to be used from the documentation for your RADIUS server.</p> <p>The default value is <i>1812</i>.</p>
<b>Server Timeout</b>	<p>Enter the maximum wait time between ACCESS_REQUEST and response in milliseconds.</p>

Field	Value
	<p>After timeout, the request is repeated according to <b>Retries</b> or the next configured RADIUS server is requested.</p> <p>Possible values are whole numbers between <i>50</i> and <i>50000</i>.</p> <p>The default value is <i>1000</i> (1 second).</p>
<b>Alive Check</b>	<p>Here you can activate a check of the accessibility of a RADIUS server in <b>Status</b> <i>Down</i> .</p> <p>An Alive Check is carried out regularly (every 20 seconds) by sending an ACCESS_REQUEST to the IP address of the RADIUS server. If the server is reachable, <b>Status</b> is set to <i>alive</i> again. If the RADIUS server is only reachable over a switched line (dialup connection), this can cause additional costs if the server is <i>down</i> for a long time.</p> <p>The function is activated by selecting <i>Enabled</i>.</p> <p>The function is enabled by default.</p>
<b>Retries</b>	<p>Enter the number of retries for cases when there is no response to a request. If an response has still not been received after these attempts, the <b>Status</b> is set to <i>down</i>. In <b>Alive Check</b> = <i>Enabled</i> your device attempts to reach the server every 20 seconds. If the server responds, <b>Status</b> is set back to <i>alive</i> .</p> <p>Possible values are whole numbers between <i>0</i> and <i>10</i>.</p> <p>The default value is <i>1</i>. To prevent <b>Status</b> being set to <i>down</i>, set this value to <i>0</i>.</p>
<b>RADIUS Dialout</b>	<p>Only for <b>Authentication Type</b> = <i>PPP Authentication</i> and <i>IPSec Authentication</i>.</p> <p>Select whether your device receives requests from RADIUS server dialout routes. This enables temporary interfaces to be configured automatically and your device can initiate outgoing connections that are not configured permanently.</p> <p>The function is activated by selecting <i>Enabled</i>.</p> <p>The function is disabled by default.</p> <p>If the function is active, you can enter the following options:</p>

Field	Value
	<ul style="list-style-type: none"> <li>• <i>Reload Interval</i>: Enter the time period in seconds between update intervals.</li> </ul> <p>The default entry here is 0 i.e. an automatic reload is not carried out.</p>

## 7.6.2 Options

This setting possible here causes your device to carry out authentication negotiation for incoming calls, if it cannot identify the calling party number (e.g. because the remote terminal does not signal the calling party number). If the data (password, partner PPP ID) obtained by executing the authentication protocol is the same as the data of a listed remote terminal or RADIUS user, your device accepts the incoming call.

The menu **System Management->Remote Authentication->Options** consists of the following fields:

### Fields in the Global RADIUS Options menu.

Field	Description
<b>Authentication for PPP Dialin</b>	<p>By default, the following authentication sequence is used for incoming calls with RADIUS: First CLID, then PPP and then PPP with RADIUS.</p> <p>Options:</p> <ul style="list-style-type: none"> <li>• <i>Inband</i>: Only inband RADIUS requests (PAP, CHAP, MS-CHAP V1 &amp; V2) (i.e. PPP requests without CLID) are sent to the RADIUS server defined in <b>Server IP Address</b>.</li> <li>• <i>Outband (CLID)</i> : Only outband RADIUS requests (i.e. requests for calling line identification = CLID) are sent to the RADIUS server.</li> </ul> <p><i>Inband</i> is enabled by default, <i>Outband (CLID)</i> is disabled by default.</p>

## 7.7 Configuration Access



In the **Configuration Access** menu you can configure user profiles.

To do so, you create access profiles and users and assign each user at least one access

profile. An access profile makes available that part of the GUI that a user requires for their tasks. Parts of the GUI that are not required are blocked.

## 7.7.1 Access Profiles

The menu **System Management->Configuration Access->Access Profiles** displays a list of all the access profiles that have been configured. You can delete existing entries with the icon .

By default, the access profiles *TCC\_ADMIN*, *HOTEL*, *CHARGES*, *PHONEBOOK*, *PBX\_USER\_ACCESS* are preconfigured for PABX systems. You can change these using the icon  or reset them to the default settings using the icon .

### 7.7.1.1 Edit or New

Choose the  icon to edit existing entries. Choose the **New** button to create additional access profiles.

To create an access profile you can use all the entries in the navigation bar of the GUI plus **Save configuration** and **Switch to SNMP Browser**. You can create a maximum of 29 access profiles.

The menu **System Management->Configuration Access->Access Profiles->New** consists of the following fields:

#### Fields in the menu Basic Settings

Field	Description
<b>Description</b>	Enter a unique name for the access profile.
<b>Level No.</b>	The system automatically assigns a sequential number to the access profile. This cannot be edited.

#### Fields in the menu Buttons

Field	Description
<b>Save configuration</b>	If you activate the button <b>Save configuration</b> the user is permitted to save configurations.









#### Note

Note that the passwords in the saved file can be viewed in clear text.

Field	Description
	<p>Enable or disable <b>Save configuration</b>.</p> <p>The function is enabled with <i>Enabled</i>.</p> <p>The function is disabled by default.</p>
<b>Switch to SNMP Browser</b>	<p>If you activate the button <b>Switch to SNMP Browser</b>, the user can switch to the SNMP browser view, access the parameters and modify all the settings displayed there.</p>
	<p> <b>Caution</b></p> <p>Note that the permission for <b>Switch to SNMP Browser</b> means that the user can access the entire MIB, because no individual access profile can be created in this view. The user can save the changed MIB with the permission for <b>Save configuration</b>.</p> <p>With the permission for <b>Switch to SNMP Browser</b> you remove the configured GUI restrictions at the MIB level once more.</p>
	<p>Enable or disable <b>Switch to SNMP Browser</b>.</p> <p>The function is enabled with <i>Enabled</i>.</p> <p>The function is disabled by default.</p>

#### Fields in the menu Navigation Entries

Field	Description
<b>Menus</b>	<p>You see all the menus from the GUI's navigation bar. Menus that contain at least one sub-menu are flagged by  and .</p> <p>The icon  indicates pages.</p> <p>When you create a new access profile, no elements are assigned yet, i.e. all the available menus, sub-menus and pages are flagged with the icon .</p> <p>Each element in the navigation bar can have three values. Click the icon  in the row you want to display these three values.</p>







Field	Description
	<p>Possible values:</p> <ul style="list-style-type: none"> <li>• <i>Deny</i>: The menu and all its lower-level menus are blocked.</li> <li>• <i>Allow</i>: The menu is released. Lower-level menus may need to be specifically released.</li> <li>• <i>Allow all</i>: The menu and all its lower-level menus are released.</li> </ul> <p>You can select <i>Allow</i> and <i>Allow all</i> in the corresponding row to assign elements to the current access profile.</p> <p>Elements that are assigned to the current access profile are flagged with the icon .</p> <p> indicates a menu that is blocked, but which has at least one released sub-menu.</p>

## 7.7.2 Users

The menu **System Management->Configuration Access->Users** displays a list of all the users that have been configured. You can delete existing entries with the icon .

There are no preconfigured users.

You can click the button  to display the details of the configured user. You can see which fields and menus are assigned to the user.

The icon   means that **Read-only** is permitted. If a row is flagged with the icon   the information is released for reading and writing. The icon   indicates blocked entries.

### 7.7.2.1 Edit or New

Choose the  icon to edit existing entries. Choose the **New** button to enter additional users.

The menu **System Management->Configuration Access->Users->New** consists of the following fields:

**Fields in the menu Basic Settings**

Field	Description
<b>User</b>	Enter a unique name for the user.
<b>Password</b>	Enter a password for the user.
<b>User must change password</b>	<p>The administrator can use the option <b>User must change password</b> to specify that the user must select their own password the first time they log in. To do this, the option <b>Save configuration</b> needs to be enabled in the menu <b>Access Profiles</b>. If this option is not enabled, a warning message displays.</p> <p>Enable or disable <b>User must change password</b>.</p> <p>The function is enabled with <i>Enabled</i>.</p> <p>The function is disabled by default.</p>
<b>Access Level</b>	<p>Use <b>Add</b> to assign at least one access profile to the user. Selecting <b>Read-only</b> specifies that the user can view the parameters of the access profile, but not change them. Selecting <b>Read-only</b> is only possible if the option <b>Switch to SNMP Browser</b> in the menu <b>Access Profiles</b> is not enabled.</p> <p>If the option <b>Switch to SNMP Browser</b> is enabled, a warning message displays because the user can switch to the SNMP browser view, access the parameters and make any changes they like. The option <b>Read-only</b> is not available in the SNMP browser view.</p> <p>If intersecting access profiles are assigned to a user, read and write have a higher priority than <b>Read-only</b>. Buttons cannot be set to the setting <b>Read-only</b>.</p>

## 7.8 Certificates

An asymmetric cryptosystem is used to encrypt data to be transported in a network, to generate or check digital signatures and the authenticate users. A key pair consisting of a public key and a private key is used to encrypt and decrypt the data.

For encryption the sender requires the public key of the recipient. The recipient decrypts the data using his private key. To ensure that the public key is the real key of the recipient and is not a forgery, a so-called digital certificate is required.

This confirms the authenticity and the owner of a public key. It is similar to an official passport in that it confirms that the holder of the passport has certain characteristics, such as

gender and age, and that the signature on the passport is authentic. As there is more than one certificate issuer, e.g. the passport office for a passport, and as such certificates can be issued by several different issuers and in varying qualities, the trustworthiness of the issuer is extremely important. The quality of a certificate is regulated by the German Signature Act or respective EU Directives.

Certification authorities that issue so-called qualified certificates are organised in a hierarchy with the Federal Network Agency as the higher certifying authority. The structure and content of a certificate are stipulated by the standard used. X.509 is the most important and the most commonly used standard for digital certificates. Qualified certificates are personal and extremely trustworthy.

Digital certificates are part of a so-called Public Key Infrastructure (PKI). PKI refers to a system that can issue, distribute and check digital certificates.

Certificates are issued for a specific period, usually one year, i.e. they have a limited validity period.

Your device is designed to use certificates for VPN connections and for voice connections over Voice over IP.

## 7.8.1 Certificate List

A list of all existing certificates is displayed in the **System Management->Certificates->Certificate List** menu.

### 7.8.1.1 Edit

Click the  icon to display the content of the selected object (key, certificate, or request).

The certificates and keys themselves cannot be changed, but a few external attributes can be changed, depending on the type of the selected entry.

The **System Management->Certificates->Certificate List->**  menu consists of the following fields:

**Fields in the Edit parameters menu.**

Field	Description
<b>Description</b>	Shows the name of the certificate, key, or request.
<b>Certificate is CA Certificate</b>	Mark the certificate as a certificate from a trustworthy certification authority (CA).



Field	Description
	<p>Certificates issued by this CA are accepted during authentication.</p> <p>The function is enabled with <i>True</i>.</p> <p>The function is disabled by default.</p>
<b>Certificate Revocation List (CRL) Checking</b>	<p>Only for <b>Certificate is CA Certificate</b> = <i>True</i></p> <p>Define the extent to which certificate revocation lists (CRLs) are to be included in the validation of certificates issued by the owner of this certificate.</p> <p>Possible settings:</p> <ul style="list-style-type: none"> <li>• <i>Disabled</i>: No CRLs check.</li> <li>• <i>Always</i>: CRLs are always checked.</li> <li>• <i>Only if a CRL Distribution Point is present</i> (default value): A check is only carried out if a CRL Distribution Point entry is included in the certificate. This can be determined under "View Details" in the certificate content.</li> <li>• <i>Use settings from superior certificate</i>: The settings of the higher level certificate are used, if one exists. If it does not, the same procedure is used as that described under "Only if a CRL Distribution Point is present".</li> </ul>
<b>Force certificate to be trusted</b>	<p>Define that this certificate is to be accepted as the user certificate without further checks during authentication.</p> <p>The function is enabled with <i>True</i>.</p> <p>The function is disabled by default.</p>



### Caution

It is extremely important for VPN security that the integrity of all certificates manually marked as trustworthy (certification authority and user certificates) is ensured. The displayed "fingerprints" can be used to check this integrity: Compare the displayed values with the fingerprints specified by the issuer of the certificate (e.g. on the Internet). It is sufficient to check one of the two values.

## 7.8.1.2 Certificate Request

### Registration authority certificates in SCEP

If SCEP (Simple Certificate Enrollment Protocol) is used, your device also supports separate registration authority certificates.

Registration authority certificates are used by some Certificate Authorities (CAs) to handle certain tasks (signature and encryption) during SCEP communication with separate keys, and to delegate the operation to separate registration authorities, if applicable.

When a certificate is downloaded automatically, i.e. if **CA Certificate** = -- *Download* -- is selected, all the certificates needed for the operation are loaded automatically.

If all the necessary certificates are already available in the system, these can also be selected manually.

Select the **Certificate Request** button to request or import more certificates.

The menu **System Management->Certificates->Certificate List->Certificate Request** consists of the following fields:

#### Fields in the Certificate Request menu.

Field	Description
<b>Certificate Request Description</b>	Enter a unique description for the certificate.
<b>Mode</b>	<p>Select the way in which you want to request the certificate.</p> <p>Possible settings:</p> <ul style="list-style-type: none"> <li>• <i>Manual</i> (default value): Your device generates a PKCS#10 for the key. This file can then be uploaded directly in the browser or copied in the  menu using the <b>View details</b> field. This file must be provided to the CA and the received certificate must then be imported manually to your device.</li> <li>• <i>SCEP</i> : The key is requested from a CA using the Simple Certificate Enrollment Protocol.</li> </ul>
<b>Generate Private Key</b>	<p>Only for <b>Mode</b> = <i>Manual</i></p> <p>Select an algorithm for key creation.</p> <p><i>RSA</i> (default value) and <i>DSA</i> are available.</p>

Field	Description
	<p>Also select the length of the key to be created.</p> <p>Possible values: <i>512, 768, 1024, 1536, 2048, 4096</i>.</p> <p>Please note that a key with a length of 512 bits could be rated as unsecure, whereas a key of 4096 bits not only needs a lot of time to create, but also occupies a major share of the resources during IPsec processing. A value of 768 or more is, however, recommended and the default value is 1024 bits.</p>
<b>SCEP URL</b>	<p>Only for <b>Mode</b> = <i>SCEP</i></p> <p>Enter the URL of the SCEP server, e.g. <code>http://scep.bintec-elmeg.com:8080/scep/scep.dll</code></p> <p>Your CA administrator can provide you with the necessary data.</p>
<b>CA Certificate</b>	<p>Only for <b>Mode</b> = <i>SCEP</i></p> <p>Select the CA certificate.</p> <ul style="list-style-type: none"> <li>In <code>-- Download --</code>: In <b>CA Name</b>, enter the name of the CA certificate of the certification authority (CA) from which you wish to request your certificate, e.g. <i>cawindows</i>. Your CA administrator can provide you with the necessary data.</li> </ul> <p>If no CA certificates are available, the device will first download the CA certificate of the relevant CA. It then continues with the enrolment process, provided no more important parameters are missing. In this case, it returns to the <b>Generate Certificate Request</b> menu.</p> <p>If the CA certificate does not contain a CRL distribution point (Certificate Revocation List, CRL), and a certificate server is not configured on the device, the validity of certificates from this CA is not checked.</p> <ul style="list-style-type: none"> <li>&lt;name of an existing certificate&gt;: If all the necessary certificates are already available in the system, you select these manually.</li> </ul>
<b>RA Sign Certificate</b>	<p>Only for <b>Mode</b> = <i>SCEP</i></p> <p>Only for <b>CA Certificate</b> not = <code>-- Download --</code></p>

Field	Description
	<p>Select a certificate for signing SCEP communication.</p> <p>The default value is <code>-- Use CA Certificate --</code>, i.e. the CA certificate is used.</p>
<b>RA Encrypt Certificate</b>	<p>Only for <b>Mode</b> = <i>SCEP</i></p> <p>Only if <b>RA Sign Certificate</b> not = <code>-- Use CA Certificate --</code></p> <p>If you use one of your own certificates to sign communication with the RA, you can select another one here to encrypt communication.</p> <p>The default value is <code>-- Use RA Sign Certificate --</code>, i.e. the same certificate is used as for signing.</p>
<b>Password</b>	<p>Only for <b>Mode</b> = <i>SCEP</i></p> <p>You may need a password from the certification authority to obtain certificates for your keys. Enter the password you received from the certification authority here.</p>

#### Fields in the **Subject Name** menu.

Field	Description
<b>Custom</b>	<p>Select whether you want to enter the name components of the subject name individually as specified by the CA or want to enter a special subject name.</p> <p>If <i>Enabled</i> is selected, a subject name can be given in <b>Summary</b> with attributes not offered in the list. Example: "CN=VPNServer, DC=mydomain, DC=com, c=DE".</p> <p>If the field is not selected, enter the name components in <b>Common Name, E-mail, Organizational Unit, Organization, Locality, State/Province</b> and <b>Country</b>.</p> <p>The function is disabled by default.</p>
<b>Summary</b>	<p>Only for <b>Custom</b> = enabled.</p> <p>Enter a subject name with attributes not offered in the list.</p> <p>Example: "CN=VPNServer, DC=mydomain, DC=com, c=DE".</p>

Field	Description
<b>Common Name</b>	Only for <b>Custom</b> = disabled. Enter the name according to CA.
<b>E-mail</b>	Only for <b>Custom</b> = disabled. Enter the e-mail address according to CA.
<b>Organizational Unit</b>	Only for <b>Custom</b> = disabled. Enter the organisational unit according to CA.
<b>Organization</b>	Only for <b>Custom</b> = disabled. Enter the organisation according to CA.
<b>Locality</b>	Only for <b>Custom</b> = disabled. Enter the location according to CA.
<b>State/Province</b>	Only for <b>Custom</b> = disabled. Enter the state/province according to CA.
<b>Country</b>	Only for <b>Custom</b> = disabled. Enter the country according to CA.

The menu **Advanced Settings** consists of the following fields:

#### Fields in the **Subject Alternative Names** menu.

Field	Description
<b>#1, #2, #3</b>	For each entry, define the type of name and enter additional subject names.  Possible values: <ul style="list-style-type: none"> <li>• <i>None</i> (default value): No additional name is entered.</li> <li>• <i>IP</i>: An IP address is entered.</li> <li>• <i>DNS</i>: A DNS name is entered.</li> <li>• <i>E-mail</i>: An e-mail address is entered.</li> <li>• <i>URI</i>: A uniform resource identifier is entered.</li> </ul>

Field	Description
	<ul style="list-style-type: none"> <li>• <i>DN</i>: A distinguished name (DN) name is entered.</li> <li>• <i>RID</i>: A registered identity (RID) is entered.</li> </ul>

#### Fields in the Options menu

Field	Description
<b>Autosave Mode</b>	<p>Select whether your device automatically stores the various steps of the enrolment internally. This is an advantage if enrolment cannot be concluded immediately. If the status has not been saved, the incomplete registration cannot be completed. As soon as the enrolment is completed and the certificate has been downloaded from the CA server, it is automatically saved in the device configuration.</p> <p>The function is enabled with <i>Enabled</i>.</p> <p>The function is enabled by default.</p>

### 7.8.1.3 Import

Choose the **Import** button to import certificates.

The menu **System Management->Certificates->Certificate List->Import** consists of the following fields:

#### Fields in the Import menu.

Field	Description
<b>External Filename</b>	Enter the file path and name of the certificate to be imported, or use <b>Browse...</b> to select it from the file browser.
<b>Local Certificate Description</b>	Enter a unique description for the certificate.
<b>File Encoding</b>	<p>Select the type of coding so that your device can decode the certificate.</p> <p>Possible values:</p> <ul style="list-style-type: none"> <li>• <i>Auto</i> (default value): Activates automatic code recognition. If downloading the certificate in auto mode fails, try with a certain type of encoding.</li> </ul>

Field	Description
	<ul style="list-style-type: none"> <li>• <i>Base64</i></li> <li>• <i>Binary</i></li> </ul>
<b>Password</b>	<p>You may need a password to obtain certificates for your keys.</p> <p>Enter the password here.</p>

## 7.8.2 CRLs

In the **System Management->Certificates->CRLs** menu, a list of all CRLs (Certification Revocation List) is displayed.

If a key is no longer to be used, e.g. because it has fallen into the wrong hands or has been lost, the corresponding certificate is declared invalid. The certification authority revokes the certificate and publishes it on a certificate blacklist, so-called CRL. Certificate users should always check against these lists to ensure that the certificate used is currently valid. This check can be automated via a browser.

The Simple Certificate Enrollment Protocol (SCEP) supports the issue and revocation of certificates in networks.

### 7.8.2.1 Import

Choose the **Import** button to import CRLs.

The **System Management->Certificates->CRLs->Import** menu consists of the following fields:

#### Fields in the CRL Import menu.

Field	Description
<b>External Filename</b>	Enter the file path and name of the CRL to be imported, or use <b>Browse...</b> to select it from the file browser.
<b>Local Certificate Description</b>	Enter a unique description for the CRL.
<b>File Encoding</b>	<p>Select the type of encoding, so that your device can decode the CRL.</p> <p>Possible values:</p> <ul style="list-style-type: none"> <li>• <i>Auto</i> (default value): Activates automatic code recognition. If</li> </ul>

Field	Description
	<p>downloading the CRL in auto mode fails, try with a certain type of encoding.</p> <ul style="list-style-type: none"> <li>• <i>Base64</i></li> <li>• <i>Binary</i></li> </ul>
<b>Password</b>	Enter the password required for the import.

### 7.8.3 Certificate Servers

A list of certificate servers is displayed in the **System Management->Certificates->Certificate Servers** menu.

A certification authority (certification service provider, Certificate Authority, CA) issues your certificates to clients applying for a certificate via a certificate server. The certificate server also issues the private key and provides certificate revocation lists (CRL) that are accessed by the device via LDAP or HTTP in order to verify certificates.

#### 7.8.3.1 New

Choose the **New** button to set up a certificate server.

The **System Management->Certificates->Certificate Servers->New** menu consists of the following fields:

**Fields in the Basic Parameters menu.**

Field	Description
<b>Description</b>	Enter a unique description for the certificate server.
<b>LDAP URL Path</b>	Enter the LDAP URL or the HTTP URL of the server.



## Chapter 8 Physical Interfaces

In this menu, you configure the physical interfaces that you have used when connecting your gateway. The configuration interface only shows the interfaces that are available on your device. In the **System Management->Status** menu, you can see a list of all physical interfaces and information on whether the interfaces are connected or active and whether they have already been configured.

### 8.1 Ethernet Ports

An Ethernet interface is a physical interface for connection to the local network or external networks.

The Ethernet ports **ETH1** to **ETH4** are assigned to a single logical Ethernet interface in ex works state. The logical Ethernet interface `en1-0` is assigned and is preconfigured with the **IP Address** `192.168.0.250` and **Netmask** `255.255.255.0` .



#### Note

To ensure your system can be reached, when splitting ports make sure that Ethernet interface `en1-0` with the preconfigured IP address and netmask is assigned to a port that can be reached via Ethernet. If in doubt, carry out the configuration using a serial connection via the **Serial 1** interface.

### ETH1 - ETH4

The interfaces can be used separately. They are logically separated from each other, each separated port is assigned the desired logical Ethernet interface in the **Ethernet Interface Selection** field of the **Port Configuration** menu. For each assigned Ethernet interface, another interface is displayed in the list in the **LAN->IP Configuration** menu, and the interface can be configured completely independently.

### VLANs for Routing Interfaces

Configure VLANs to separate individual network segments from each other, for example (e.g. individual departments of a company) or to reserve bandwidth for individual VLANs when managed switches are used with the QoS function.

## 8.1.1 Port Configuration

### Port Separation

Your device makes it possible to run the switch ports as one interface or to logically separate these from each other and to configure them as independent Ethernet interfaces.

During configuration, please note the following: The splitting of the switch ports into several Ethernet interfaces merely logically separates these from each other. The available total bandwidth of max. 1000 mbps full duplex for all resulting interfaces remains the same. For example, if you split all the switch ports from each other, each of the resulting interfaces only uses a part of the total bandwidth. If you group together several switch ports into one interface, the full bandwidth of max. 1000 mbps full duplex is available for all the ports together.

The menu **Physical Interfaces->Ethernet Ports->Port Configuration** consists of the following fields:

#### Fields in the Switch Configuration menu.

Field	Description
<b>Switch Port</b>	Shows the respective switch port. The numbering corresponds to the numbering of the Ethernet ports on the back of the device.
<b>Ethernet Interface Selection</b>	Assign a logical Ethernet interface to the switch port.  You can select from four interfaces, <i>en1-0</i> to <i>en1-4</i> . In the basic setting, switch port <b>1 - 4</b> has the <i>en1-0</i> interface assigned to it.
<b>Configured Speed / Mode</b>	Select the mode in which the interface is to run.  Possible values: <ul style="list-style-type: none"> <li>• <i>Full Autonegotiation</i> (default value)</li> <li>• <i>Auto 1000 mbps only</i></li> <li>• <i>Auto 100 mbps only</i></li> <li>• <i>Auto 10 mbps only</i></li> <li>• <i>Auto 100 mbps / Full Duplex</i></li> <li>• <i>Auto 100 mbps / Half Duplex</i></li> </ul>

Field	Description
	<ul style="list-style-type: none"> <li>• <i>Auto 10 mbps / Full Duplex</i></li> <li>• <i>Auto 10 mbps / Half Duplex</i></li> <li>• <i>Fixed 1000 mbps / Full Duplex</i></li> <li>• <i>Fixed 100 mbps / Full Duplex</i></li> <li>• <i>Fixed 100 mbps / Half Duplex</i></li> <li>• <i>Fixed 10 mbps / Full Duplex</i></li> <li>• <i>Fixed 10 mbps / Half Duplex</i></li> <li>• <i>None: The interface is created but remains inactive.</i></li> </ul>
<b>Current Speed / Mode</b>	<p>Shows the actual mode and actual speed of the admin interface.</p> <p>Possible values:</p> <ul style="list-style-type: none"> <li>• <i>1000 mbps / Full Duplex</i></li> <li>• <i>100 mbps / Full Duplex</i></li> <li>• <i>100 mbps / Half Duplex</i></li> <li>• <i>10 mbps / Full Duplex</i></li> <li>• <i>10 mbps / Half Duplex</i></li> <li>• <i>Down</i></li> </ul>
<b>Flow Control</b>	<p>Select whether a flow control should be conducted on the corresponding interface.</p> <p>Possible values:</p> <ul style="list-style-type: none"> <li>• <i>Disabled</i> (default value): No flow control is performed.</li> <li>• <i>Enabled</i>. Flow will be controlled.</li> <li>• <i>Auto</i>: Flow will be controlled automatically.</li> </ul>

## 8.2 ISDN Ports

The ISDN connections of the system are as internal ISDN connections provided for connecting various ISDN terminals (system telephones, ISDN telephones, ...).



### Note

Without an adapter which is available as an accessory, both ISDN connections can only be operated as internal ISDN connections (NT mode). If you have connected the adapter, you can switch the corresponding port to external operation (TE mode) in this menu.

Note that switching the operation mode is only possible if your device has been manufactured in 2016. You can determine if this is the case if a unique WLAN password is printed on the type label of your device.

## 8.2.1 ISDN External

You configure your system's external ISDN connections in the **Physical Interfaces->ISDN Ports->ISDN External** menu.

The access configuration for an external ISDN can be set up for point-to-multipoint (P-MP) and point-to-point (P-P).

The following variants are possible when connecting to more than one ISDN connection:

- All external ISDN connections are only point-to-multipoint connections (P-MP).
- All external ISDN connections are only point-to-point connections (P-P).
- The external ISDN connections are point-to-multipoint connections (P-MP) and point-to-point connections (P-P).

### 8.2.1.1 Edit

Choose the  button to edit an entry.

The menu **Physical Interfaces->ISDN Ports->ISDN External->**  consists of the following fields:

**Fields in the Basic Settings menu.**

Field	Description
<b>Description</b>	Enter a user-defined description of the ISDN interface.
<b>Name</b>	Shows the name of the ISDN interface.  Possible values: <ul style="list-style-type: none"> <li>• <i>Module Slot</i>: Displays the slot in which the module with</li> </ul>

Field	Description
	<p>the ISDN interface is inserted.</p> <ul style="list-style-type: none"> <li>• /: Displays the port on the module to which the ISDN connection is connected.</li> <li>• <i>S/U</i>: 4 wire (S)</li> </ul> <p>Example: <i>Module slot 3/2 S/U</i>= The interface is located on the module inserted in slot 3 on port 2, and is used as an S connection.</p>
<b>Access Type</b>	<p>Select whether the ISDN interface will be operated as a point-to-multipoint connection or as a point-to-point connection.</p> <p>Possible values:</p> <ul style="list-style-type: none"> <li>• <i>ISDN P-MP</i></li> <li>• <i>ISDN P-P</i></li> </ul>

The menu **Advanced Settings** consists of the following fields:

#### Fields in the **Advanced Settings** menu.

Field	Description
<b>Permanent Layer 2 Activation</b>	<p>This function (also known as permanent monitoring) constantly monitors the functionality and transmission quality of an external ISDN connection. For this purpose, the system is in permanent contact with your network operator's exchange. If the exchange does not keep the ISDN layer 2 permanently enabled, the system can initiate the repeated establishment of layer 2.</p> <p>The function is activated by selecting <i>Enabled</i>.</p> <p>The function is disabled by default.</p>
<b>ISDN Synchronisation</b>	<p>When an external device (e. g. GSM gateway) is connected to an external point-to-point ISDN access in the system, the external device's signal can disturb the synchronisation in the ISDN signal. Only if such a disturbance occurs should you switch off the layer 1 synchronisation.</p> <p>The function is activated by selecting <i>Enabled</i>.</p> <p>The function is enabled by default.</p>

## 8.2.2 ISDN Internal

You configure your system's internal ISDN interfaces in the **Physical Interfaces->ISDN Ports->ISDN Internal** menu.

The internal ISDN interfaces are designed for connecting different kinds of ISDN terminals (system phones, ISDN phones, etc.)

Two predefined entries with the parameters **Name** = *S/U 1*, **Usage** = *S0*, **Default MSN** = *30 (ISDN 30)*

and *S/U 2*, **Function** = **Default MSN** *S0* and **Default MSN** = *35 (ISDN 35)*

are displayed.

Internal ISDN connections are always point-to-multipoint connections

When connecting terminals to an internal ISDN connection, please note that not all commercially available ISDN terminals can use the performance features offered by the system via your key interface.

The **Physical Interfaces->ISDN Ports->ISDN Internal** menu consists of the following fields:

### Fields in the ISDN Internal menu

Field	Description
<b>Name</b>	<p>Displays the designation of the ISDN interface.</p> <p>Possible values:</p> <ul style="list-style-type: none"> <li>• <i>S/U</i>: 4 wire (S)</li> <li>• <i>/</i>: Displays the port on the module to which the ISDN interface is connected.</li> </ul> <p>Example: <i>S/U 2</i> = The interface is in port 2 and is used as an S-connector.</p>
<b>Function</b>	<p>Displays the function of the ISDN interface.</p> <p>Possible values:</p> <ul style="list-style-type: none"> <li>• <i>Upn</i>: Interface for UPN terminals.</li> <li>• <i>S0</i>: Interface for ISDN S0 connection.</li> </ul>

Field	Description
<b>default MSN</b>	Shows whether a standard MSN has been assigned for an internal S0 bus.  You cannot access configured S0 terminals via a standard MSN.  As standard MSN, you can dial internal numbers that have been configured in the <b>Numbering-&gt;User Settings-&gt;Users</b> menu and which have been assigned to a terminal in the <b>Terminals</b> menu.
<b>Status</b>	Displays the status of the interface.

### 8.2.2.1 Edit

Choose the  button to edit an entry.

The menu **Physical Interfaces->ISDN Ports->ISDN Internal->**  consists of the following fields:

#### Fields in the Basic Settings menu

Field	Description
<b>default MSN</b>	Dial the required extension. You can dial under the numbers that you have configured in the <b>Numbering-&gt;User Settings-&gt;Users-&gt;Numbers</b> menu.  Possible values: <ul style="list-style-type: none"> <li>• <i>Not configured</i></li> <li>• <i>&lt;Number&gt;</i></li> </ul>

## 8.2.3 ISDN Configuration

Switching the ISDN connections to external operation (TE mode) requires an adapter that is available as an accessory. Otherwise, both ISDN connections can only be operated as internal connections (NT mode). If you have attached the respective adapter, you can switch the corresponding port to external operation in this menu.



## 8.3 Analogue Ports

### 8.3.1 Analogue External (FXO)

The **Analogue External (FXO)** menu displays all of your system's available analogue external connections.

The **Physical Interfaces->Analogue Ports->Analogue External (FXO)** menu consists of the following fields:

#### Values in the Analogue External (FXO) list

Field	Description
<b>Name</b>	Shows the name of the analogue interface.  Possible values: <ul style="list-style-type: none"> <li>• <i>FXO</i>: Name for the analogue connection.</li> </ul>
<b>Description</b>	Shows the user-defined description of the analogue interface.
<b>Dialling Method</b>	Displays the dialling method used.  Possible values: <ul style="list-style-type: none"> <li>• <i>Tone Dialling (DTMF)</i> (default value)</li> <li>• <i>Pulse Dialling (PD)</i></li> </ul>
<b>Status</b>	Displays the status of the interface.
<b>Action</b>	Change the status of the interface by pressing the  button or  button in the <b>Action</b> column.

#### 8.3.1.1 Edit

Choose the  button to edit an entry.

The menu **Physical Interfaces->Analogue Ports->Analogue External (FXO)->**  consists of the following fields:

**Fields in the Basic Settings menu.**



Field	Description
<b>Description</b>	Enter a user-defined description of the analogue interface.
<b>Name</b>	Shows the name of the analogue interface.  Possible values: <ul style="list-style-type: none"> <li>• <i>FXO</i>: Name for the analogue connection.</li> </ul>
<b>Dialling Method</b>	Select which dialling method should be used.  Possible values: <ul style="list-style-type: none"> <li>• <i>Tone Dialling (DTMF)</i> (default value)</li> <li>• <i>Pulse Dialling (PD)</i></li> </ul>
<b>CLIP</b>	Select whether the CLIP feature is to be used, i. e. whether the caller's number should be displayed to the person called.  Possible values: <ul style="list-style-type: none"> <li>• <i>Off</i> (default value): The caller's number is not displayed to the person called.</li> <li>• <i>FSK</i>: The data is sent as DTMF.</li> </ul>
<b>Receive charges</b>	Select whether your device is to receive charge information from the network. For this purpose, you can define the charge impulse at 12 kHz or 16 kHz.  Possible values: <ul style="list-style-type: none"> <li>• <i>Off</i> (default value) Charge information is not received.</li> <li>• <i>12 kHz</i></li> <li>• <i>16 kHz</i></li> </ul>

#### Fields in the **Advanced Settings** menu.

Field	Description
<b>Busy Tone Detection</b>	Select whether <b>Busy Tone Detection</b> should be used.  The function is activated by selecting <i>Enabled</i> .  The function is enabled by default.
<b>Dial Tone Detection</b>	Select whether <b>Dial Tone Detection</b> should be used.

Field	Description
	<p>The function is activated by selecting <i>Enabled</i>.</p> <p>The function is enabled by default.</p> <p>If the <b>Dial Tone Detection</b> is enabled and the external dial tone has been recognised, your <b>be.IP plus - world edition</b> immediately starts to dial.</p>
<b>Dial Tone Pause</b>	<p>Only for <b>Dial Tone Detection</b> disabled.</p> <p>Enter the value you want which the system is to wait for, as a maximum, when dialling a telephone number, before it begins dialling.</p> <p>You can switch on the <b>Dial Tone Pause</b> if the <b>be.IP plus - world edition</b> fails to recognise the external dial tone or if no dial tone is being sent. You must decide the duration of the <b>Dial Tone Pause</b>.</p> <p>Possible values are whole number values between 1 second and 5 seconds.</p> <p>The default value is 1 second.</p>
<b>End-of-Selection Signal</b>	<p>Enter the time that the system is to wait, after dialling a number, before it considers the telephone number to be complete and makes the connection. The default value is 5 seconds.</p>

### 8.3.2 Analogue Internal (FXS)

The **Analogue Internal (FXS)** menu displays all of your system's available analogue internal connections.

The menu **Physical Interfaces->Analogue Ports->Analogue Internal (FXS)** consists of the following fields:

#### Values in the Analogue Internal (FXS) list

Field	Description
<b>Name</b>	<p>Shows the name of the analogue interface.</p> <p>Possible values:</p>

Field	Description
	<ul style="list-style-type: none"> <li>• <i>FXS</i>: Name for the analogue connection.</li> </ul>
<b>Usage</b>	<p>Shows the usage of the analogue interface.</p> <p>Possible values:</p> <ul style="list-style-type: none"> <li>• <i>Telephone</i></li> <li>• <i>Doorcom Units</i></li> <li>• <i>Multi Function Device/Telefax</i></li> <li>• <i>Modem</i></li> <li>• <i>Answering Machine</i></li> <li>• <i>Emergency Phone</i></li> </ul> <p>The function of the analogue terminal is configured in the <b>Terminals-&gt;Other phones-&gt;analog</b> menu.</p>
<b>Status</b>	Displays the status of the interface.

## 8.4 DSL Modem

The ADSL modem is ideal for high-speed Internet access and remote access use in SMEs or remote offices.

### 8.4.1 DSL Configuration

In this menu, you make the basic settings for your ADSL connection.

The menu **Physical Interfaces->DSL Modem->DSL Configuration** consists of the following fields:

**Fields in the DSL Port Status menu.**

Field	Description
<b>DSL Chipset</b>	Shows the key of the installed chipset.
<b>Physical Connection</b>	<p>Shows the current ADSL operation mode. The value cannot be changed.</p> <p>Possible values:</p>

Field	Description
	<ul style="list-style-type: none"> <li>• <i>Unknown</i>: The ADSL link is not active.</li> <li>• <i>ANSI T1.413</i>: ANSI T1.413</li> <li>• <i>ADSL1</i>: ADSL classic, G.DMT, ITU G.992.1</li> <li>• <i>G.lite G992.2</i>: Splitterless ADSL, ITU G.992.2</li> <li>• <i>ADSL2</i>: G.DMT.Bis, ITU G.992.3</li> <li>• <i>ADSL2 DELT</i>: ADSL2 Double Ended Line Test</li> <li>• <i>ADSL2 Plus</i>: ADSL2 Plus, ITU G.992.5</li> <li>• <i>ADSL2 Plus DELT</i>: ADSL2 Plus Double Ended Line Test</li> <li>• <i>READSL2</i>: Reach Extended ADSL2</li> <li>• <i>READSL2 DELT</i>: Reach Extended ADSL2 Double Ended Line Test.</li> <li>• <i>ADSL2 ITU-T G.992.3 Annex M</i></li> <li>• <i>ADSL2+ ITU-T G.992.5 Annex M</i></li> <li>• <i>ADSL2 Annex J</i></li> <li>• <i>ADSL2+ Annex J</i></li> </ul>

#### Fields in the **Current Line Speed** menu.

Field	Description
<b>Downstream</b>	Displays the data rate in the receive direction (direction from CO/DSLAM to CPE/router) in bits per second. The value cannot be changed.
<b>Upstream</b>	Displays the data rate in the send direction (direction from CPE/router to CO/DSLAM) in bits per second.  The value cannot be changed.

#### Fields in the **DSL Parameter** menu.

Field	Description
<b>DSL Mode</b>	<p>Select the ADSL synchronization type.</p> <p>Possible values:</p> <ul style="list-style-type: none"> <li>• <i>ADSL Automode</i> (default value): The ADSL mode is automatically adapted for the remote terminal.</li> <li>• <i>ADSL1</i> :ADSL1 / G.DMT is used.</li> </ul>

Field	Description
	<ul style="list-style-type: none"> <li>• <i>ADSL2</i>: ADSL2 / G.992.3 is used.</li> <li>• <i>ADSL2 Plus</i>: ADSL2 Plus / G.992.5 is used.</li> <li>• <i>Automode (Annex-M)</i>: Only for Annex A devices. The ADSL mode is automatically adapted to the other end with reference to G.992.3 Annex M.</li> <li>• <i>ADSL2 Plus (Annex-M)</i>: Only for Annex A devices. ADSL2 Plus / G.992.3 Annex M is used.</li> <li>• <i>ADSL2 Annex J</i>: Only for Annex J devices. ADSL2 Plus / G.992.3 Annex J is used.</li> <li>• <i>ADSL2+ Annex J</i>: Only for Annex J devices. ADSL2 Plus / G.992.5 Annex J is used.</li> <li>• <i>Inactive</i>: The ADSL interface is not active.</li> </ul>
<b>Transmit Shaping</b>	<p>Select whether the data rate in the send direction is to be reduced. This is only needed in a few cases for special DSLAMs.</p> <p>Possible values:</p> <ul style="list-style-type: none"> <li>• <i>Default (Line Speed)</i> (default value): The data rate in the send direction is not reduced.</li> <li>• <i>128,000 bps to 2,048,000 bps</i>: The data rate in the send direction is reduced to a maximum of 128,000 bps to 2,048,000 bps in defined steps.</li> <li>• <i>User-defined</i>: The data rate is reduced to the value entered in <b>Maximum Upstream Bandwidth</b>.</li> </ul> <p>The default value is <i>Default (Line Speed)</i>.</p>
<b>Maximum Upstream Bandwidth</b>	<p>Only for <b>Transmit Shaping</b> = <i>User-defined</i></p> <p>Enter the maximum data rate in the send direction in bits per second.</p>

The menu **Advanced Settings** consists of the following fields:

#### Fields in the **Advanced Settings** menu.

Field	Description
<b>ADSL Line Profile</b>	<p>Select the internet service provider you require and, in doing so, implicitly select the modem parameter set used by this provider.</p> <p><i>Deutsche Telekom</i> is entered as the default value.</p>

Field	Description
	If your provider is not shown in the list, use the <i>default</i> setting.

## 8.5 UMTS/LTE

### 8.5.1 UMTS/LTE

In the **UMTS/LTE** menu, configure the connection for the integrated UMTS/HSDPA/LTE modem (depending on the configuration of your device) or an optional pluggable UMTS/LTE USB stick.

A list of compatible UMTS/LTE USB sticks can be found at [www.bintec-elmeg.com](http://www.bintec-elmeg.com) under **Products**.



#### Note

If you are connecting to the internet via UMTS and are using the SMS alert service, the connection is briefly interrupted when an SMS is sent.



#### Note

LTE cannot currently be used for incoming connections via ISDN login.

LTE cannot currently be used together with the SMS alert service.

#### 8.5.1.1 Edit

Click the  icon to edit the respective entry for the integrated modem or a plugged UMTS/LTE USB stick.

Select the following entry for the corresponding UMTS/LTE modem:

- *Slot6 Unit 0*: The integrated modem is to be configured.
- *Slot6 Unit 1*: The plug-in UMTS USB stick is to be configured.

**Note**

Please note that the technology used not only depends on availability and the setting in the **Preferred Network Type** field; rather it is also determined by the strength and quality of the signal.

The menu **Physical Interfaces->UMTS/LTE->UMTS/LTE->**  consists of the following fields:



**Fields in the Basic Settings menu.**



Field	Description
<b>UMTS/LTE Status</b>	<p>Select whether the chosen UMTS/LTE modem should be enabled or disabled.</p> <p>The function is enabled with <i>Enabled</i>.</p> <p>The function is enabled by default.</p>
<b>Modem Status</b>	<p>Only for <b>UMTS/LTE Status</b> = <i>Enabled</i></p> <p>Shows the status of the UMTS/LTE modem.</p> <p>Possible values:</p> <ul style="list-style-type: none"> <li>• <i>Up</i></li> <li>• <i>Down</i></li> <li>• <i>Init</i></li> <li>• <i>Called</i></li> <li>• <i>Calling</i></li> <li>• <i>Connect</i></li> <li>• <i>SIM insert required</i></li> <li>• <i>PIN input required</i></li> <li>• <i>Error</i></li> <li>• <i>Disconnected</i></li> </ul>
<b>Network Provider</b>	<p>Only for <b>UMTS/LTE Status</b> = <i>Enabled</i></p> <p>This is only displayed if the status of the modem is "up".</p> <p>Displays the <b>Network Provider</b> currently connected.</p>

Field	Description
<b>Actual Network</b>	<p>Only for <b>UMTS/LTE Status</b> = <i>Enabled</i></p> <p>Displays the current network, e.g. GSM or UMTS.</p>
<b>Network Quality</b>	<p>Only for <b>UMTS/LTE Status</b> = <i>Enabled</i></p> <p>Displays the current quality of the UMTS/LTE connection. The value cannot be changed.</p>
<b>Preferred Network Type</b>	<p>Only for <b>UMTS/LTE Status</b> = <i>Enabled</i></p> <p>Select which network type should preferably be used.</p> <p>Possible values:</p> <ul style="list-style-type: none"> <li>• <i>Automatic</i> (default value): GPRS, UMTS or LTE is automatically selected for the connection, depending on which network type is locally available.</li> <li>• <i>GPRS only</i>: Only GPRS is used; should GPRS not be available, no connection is established.</li> <li>• <i>UMTS only</i>: Only UMTS is used; should UMTS not be available, no connection is established.</li> <li>• <i>GPRS preferred</i>: GPRS is preferentially used; should GPRS not be available, UMTS is used.</li> <li>• <i>UMTS preferred</i>: UMTS is preferentially used; should UMTS not be available, GPRS is used.</li> <li>• <i>LTE only</i>: Only LTE is used; should LTE be unavailable, no connection is established.</li> <li>• <i>LTE preferred (Priority 4G/3G/2G)</i>: LTE is preferably used; should LTE be unavailable, UMTS is used, and if UMTS is unavailable, GPRS is used.</li> <li>• <i>LTE/UMTS (Priority 4G/3G)</i>: LTE is used. If the strength and quality of the signal are insufficient with LTE then UMTS is used.</li> <li>• <i>LTE/GPRS (Priority 4G/2G)</i>: LTE is used. If the strength and quality of the signal are insufficient with LTE then GPRS is used.</li> <li>• <i>LTE/GPRS/UMTS (Priority 4G/2G/3G)</i>: LTE is used. If the strength and quality of the signal are insufficient with LTE then GPRS is used. If the strength and quality of the signal are insufficient with GPRS then UMTS is used.</li> </ul>



Field	Description
	<ul style="list-style-type: none"> <li>• <i>UMTS/LTE (Priority 3G/4G)</i>: UMTS is used. If the strength and quality of the signal are insufficient with UMTS then LTE is used.</li> <li>• <i>UMTS/GPRS (Priority 3G/2G)</i>: UMTS is used. If the strength and quality of the signal are insufficient with UMTS then GPRS is used.</li> <li>• <i>UMTS/LTE/GPRS (Priority 3G/4G/2G)</i>: UMTS is used. If the strength and quality of the signal are insufficient with UMTS then LTE is used. If the strength and quality of the signal are insufficient with LTE then GPRS is used.</li> <li>• <i>GPRS/LTE (Priority 2G/4G)</i>: GPRS is used. If the strength and quality of the signal are insufficient with GPRS then LTE is used.</li> <li>• <i>GPRS/UMTS (Priority 2G/3G)</i>: GPRS is used. If the strength and quality of the signal are insufficient with GPRS then UMTS is used.</li> <li>• <i>GPRS/LTE/UMTS (Priority 2G/4G/3G)</i>: GPRS is used. If the strength and quality of the signal are insufficient with GPRS then LTE is used. If the strength and quality of the signal are insufficient with LTE then UMTS is used.</li> </ul> <div style="border: 1px solid #ccc; padding: 10px; margin-top: 10px;"> <p> <b>Note</b></p> <p>An incoming data call (PPP dialin or ISDN login via V.110) can generally only be set up via GSM. Setup for UMTS/LTE is generally only possible if the provider has activated this functionality on demand.</p> <p>When a modem is in the "up" state and <b>Preferred Network Type</b> is not <i>UMTS only</i>, the modem normally logs in to the GSM network, so that incoming data calls can be signalled. If a connection to the Internet is then established, there occurs a switch to the UMTS network, provided that UMTS is currently available.</p> </div>
<b>Incoming Service Type</b>	<p>Only for <b>UMTS/LTE Status</b> = <i>Enabled</i></p> <p>Here you select the gateway subsystem to which an incoming call over the modem is to be assigned.</p>

Field	Description
	<p>Possible values:</p> <ul style="list-style-type: none"> <li>• <i>Disabled</i>: Call is not accepted (default value for LTE connections).</li> <li>• <i>ISDN Login</i>: The call is assigned to the ISDN Login subsystem (default value for UMTS connections).</li> <li>• <i>PPP Dialin</i>: The call is assigned to the PPP subsystem.</li> <li>• <i>IPSec</i>: The call is made via IPSec.</li> </ul> <p>Please note the following for the setting <b>Incoming Service Type</b> <i>IPSec</i>:</p> <p>IPSec callback is used to cause an IPSec peer to set up an Internet connection, thus allowing an IPSec tunnel over the Internet. You can make a direct call via the UMTS/LTE wireless network in order to signal to a peer that you are online and waiting for an IPSec tunnel to be set up over the Internet. If the called peer currently has no connection to the Internet, the mobile call causes a connection to be set up.</p> <p>In the <b>VPN-&gt;IPSec-&gt;IPSec Peers-&gt;</b><b>-&gt;Advanced Settings</b> menu, you can also choose whether the IP address for IPSec tunnel setup should be transmitted with the UMTS/LTE callback call under <b>Transfer own IP address over ISDN/GSM</b>. This may shorten and simplify tunnel setup.</p>
<b>PUK</b>	<p>This is only displayed if the device has made three failed attempts to establish a connection, e.g. if the PIN for the SIM card (see the <b>SIM Card Uses PIN</b> field) has been entered incorrectly three times.</p> <p>Enter the PUK (personal unblocking key) for your SIM card to unblock the SIM card.</p>
<b>SIM Card Uses PIN</b>	<p>Only for <b>UMTS/LTE Status</b> = <i>Enabled</i></p> <p>Enter the PIN for your UMTS/LTE modem card.</p>
	<p> <b>Note</b></p> <p>Entering a wrong PIN blocks communication until the entry is corrected.</p>

Field	Description
	<div style="border: 1px solid gray; padding: 10px; background-color: #f0f0f0;">  <p><b>Note</b></p> <p>If the device has made three failed attempts to establish a connection, e.g. because the PIN has been entered incorrectly three times, you will need to enter the <b>PUK</b> in order to unblock the SIM card.</p> </div>
<b>Fallback Number</b>	<p>Only for <b>UMTS/LTE Status</b> = <i>Enabled</i></p> <p>Enter the call number for the GSM fallback function.</p> <p>When a voice calls goes in on this number, any active connection is immediately disconnected and the operating mode of the modem reset to GSM, where the modem remains until another data call (PPP, ISDN login, IPsec callback) comes in. If flat-rate mode is enabled for the WAN connection (option <b>Always active</b> enabled in <b>WAN-&gt;Internet + Dialup-&gt;UMTS/LTE-&gt;</b> ) , this means that the connection will be re-established immediately.</p>
	<div style="border: 1px solid gray; padding: 10px; background-color: #f0f0f0;">  <p><b>Note</b></p> <p>Please note that the SIM card must support this function, and that not all mobile telephony providers relay voice calls over data SIM cards.</p> </div>
<b>APN (Access Point Name)</b>	<p>Only for <b>UMTS/LTE Status</b> = <i>Enabled</i></p> <p>If GPRS/UMTS/LTE is to be used, you must enter the so-called Access Point Name that you received from your provider here. A maximum of 80 characters can be entered.</p> <p>If no APN or an incorrect APN has been entered, a configured GPRS/UMTS/LTE connection will not function.</p>

The menu **Advanced Settings** consists of the following fields:

#### Fields in the menu **Roaming/PLMN Selection**

Field	Description
<b>Roaming Mode</b>	Select if you intend to use Roaming.

Field	Description
	<p>Possible values:</p> <ul style="list-style-type: none"> <li>• <i>Disabled</i>: Roaming is disabled. The Home PLMN (Public Land Mobile Network) is used, i.e. the provider the SIM card is registered at.</li> <li>• <i>Auto Select</i>(Default setting): Use this mode if neither <b>Roaming Mode = Disabled</b> nor <b>Roaming Mode = Fixed</b> suits your requirements. Note that first a scan across all APNs is carried out in this mode. The system tries to use cost-efficient routing in order to reduce roaming charges.</li> <li>• <i>Unrestricted</i>: This mode is intended for specific requirements. Note that first a scan across all APNs is carried out in this mode.</li> <li>• <i>Fixed Operator</i>: At <b>Roaming Mode = Fixed</b> no scan is performed, and only the manually selected <b>Mobile Network Provider</b> is used. If the selected <b>Mobile Network Provider</b> is unavailable, no connection is made.</li> <li>• <i>Full Auto Select</i>: No scan is performed with this selection. The modem automatically selects the strongest <b>Mobile Network Provider</b>. Close to a country border this could also be the network of a foreign roaming partner.</li> </ul>
<b>Mobile Network Provider</b>	<p>Only for <b>Roaming Mode = Fixed Operator</b></p> <p>Select a <b>Mobile Network Provider</b> from the list.</p> <p>Possible values</p> <ul style="list-style-type: none"> <li>• &lt;Provider&gt;: Select a <b>Mobile Network Provider</b> from the list.</li> <li>• <i>Manual Selection</i>: This allows entering a Provider ID (PLMN) manually.</li> </ul>
<b>Mobile Network Provider</b>	<p>Here you can add a PLMN (Public Land Mobile Network).</p> <p>Every mobile network is identified by a globally unique identifier that consists of the MCC (Mobile Country Code) and the MNC (Mobile Network Code). The MCC for Germany, e.g. is 262, and the MNC for T-Mobile in Germany is 01. This results in the PLMN <i>26201</i>.</p>

Fields in the menu **Closed User Group**

Field	Description
<b>Authentication APN</b>	Enter the Authentication Access Point Name for the <b>Closed User Group</b> , that you have received from your provider.
<b>Authentication Method</b>	<p>Select an authentication protocol for the <b>Closed User Group</b>. Select only an authentication method that has been specified by your provider.</p> <p>Possible values:</p> <ul style="list-style-type: none"> <li>• <i>None</i>: Some providers do not use authentication. Select this option if your provider is among them.</li> <li>• <i>pap</i>: Execute only PAP (PPP Password Authentication Protocol), the password is sent unencrypted.</li> <li>• <i>chap</i>: Execute only CHAP (PPP Challenge Handshake Authentication Protocol according to RFC 1994) the password is sent encrypted.</li> <li>• <i>pap-chap</i> (Default value): Prefer CHAP, use PAP if not available.</li> </ul>
<b>Username</b>	Enter the user name that has been supplied by your provider.
<b>Password</b>	Enter the password that has been supplied by your provider.
<b>Fixed IP Address</b>	Enter the Ip address that has been supplied by your provider.

Clicking the  button opens a page with detailed statistics on the current UMTS/LTE connection.

#### Values in the list **Mobile Device Status**

Field	Description
<b>Device</b>	Displays the description of the internal modem port.
<b>Modem Model</b>	Displays the modem model description.
<b>IMEI</b>	The IMEI (International Mobile Station Equipment Identity) displays the 15 digit serial number of the modem.
<b>Oper Status</b>	Displays the operation mode of the modem.
<b>ICC ID</b>	Displays the card ID stored on the SIM card.
<b>Subscriber Number</b>	Displays the calling number stored on the SIM card.
<b>Service Center Address</b>	Displays the address of the provider's service center stored on the SIM card.

Field	Description
<b>Home PLMN</b>	Displays the Home PLMN (Public Land Mobile Network), i.e. the provider the SIM card is registered at.
<b>Selected PLMN</b>	Displays the selected PLMN. If no PLMN is selected, the Home PLMN is displayed.
<b>Actual Network</b>	Displays which kind of network is currently used (e.g., UMTS or GPRS).
<b>Network Quality</b>	Displays the current connection quality.
<b>Location Area Code</b>	Displays the radio cell code of the cell the modem is currently connected to.
<b>Cell ID</b>	Displays the Cell ID of the cell the modem is currently registered in.
<b>Last Command</b>	Displays the last command sent to the modem by the system.
<b>Last Reply</b>	Displays the last reply sent by the modem.

#### Values in the list **Mobile Operators**

Field	Description
<b>PLMN</b>	Displays the PLMN of the carrier.
<b>Name</b>	Displays the name of the carrier.
<b>Access Type</b>	Displays the currently available network type (e.g., UMTS oder GSM).
<b>State</b>	Displays the registration status.

## Chapter 9 VoIP

Voice over IP (VoIP) uses the IP protocol for voice and video transmission.

The main difference compared with conventional telephony is that the voice information is not transmitted over a switched connection in a telephone network, but divided into data packets by the Internet protocol and these packets are then passed to the destination over undefined paths in a network. This technology uses the existing network infrastructure for voice transmission and shares this with other communication services.

### 9.1 Settings



You set up your VoIP connections in the **VoIP->Settings** menu.

You can telephone over the internet using all internally connected telephones. The number of connections depends on various parameters:

- The availability of the system's free channels.
- The available bandwidth of the DSL connection.
- The configured, available SIP providers.
- The SIP-out licenses that have been entered.

#### 9.1.1 SIP Provider

You configure the SIP provider you want in the **VoIP->Settings->SIP Provider** menu.

You change the status of the SIP provider by pressing the  button or the  button in the **Action** column.

After about one minute, registration with the provider has taken place and the status is automatically set to  (active).

##### 9.1.1.1 Edit or New

Choose the  icon to edit existing entries. Select the **New** button to create new entries.

The menu **VoIP->Settings->SIP Provider->New** consists of the following fields:

**Fields in the Basic Settings menu.**

Field	Description
<b>Description</b>	You can enter a name for the SIP provider. A 20 digit alpha-numeric sequence is possible.
<b>Provider Status</b>	Select whether this VoIP provider entry is enabled ( <i>Enabled</i> , default value) or not ( <i>disabled</i> ).
<b>Access Type</b>	Select which type of VoIP phonenumbers you wish to configure.  Possible values: <ul style="list-style-type: none"> <li>• <i>Single Number(s)</i> (default value): Enter the individual DSL phonenumbers.</li> <li>• <i>Direct Dial-In</i>: Enter a basic number in conjunction with an extension number block.</li> </ul>
<b>Authentication ID</b>	Enter your provider's authentication ID. A 64 digit alpha-numeric sequence is possible.
<b>Password</b>	At this point, you can assign a password. A 64 digit alpha-numeric sequence is possible.
<b>User Name</b>	Enter the user name you received from your VoIP provider. A 64 digit alpha-numeric sequence is possible.
<b>Domain</b>	Enter a new domain name or a new IP address for the SIP proxy server.  If you do not make an entry, the entry in the <b>Registrar</b> field is used.  Note: Enter a name or IP address only if this is explicitly specified by the provider.

#### Fields in the **Outgoing Signalisation Settings** menu.

Field	Description
<b>Outgoing Signalisation</b>	Select the signal you want for outgoing calls.  Possible values: <ul style="list-style-type: none"> <li>• <i>Standard</i> (default value)</li> <li>• <i>Global CLIP no Screening Number</i></li> <li>• <i>Individual CLIP no Screening Number</i></li> </ul>



Field	Description
	<ul style="list-style-type: none"> <li>• <i>Fixed Out DDI</i> (Only for <b>Access Type</b> = <i>Direct Dial-In</i>)</li> </ul>
<b>Global CLIP no Screening Number</b>	<p>Only for <b>Outgoing Signalisation</b> <i>Global CLIP no Screening Number</i></p> <p>Enter the number that is to be displayed to the person called with any outward connection.</p> <p>This number is not checked.</p>
<b>Signal remote caller number</b>	<p>Only for <b>Outgoing Signalisation</b> = <i>Global CLIP no Screening Number</i> and <i>Individual CLIP no Screening Number</i></p> <p>You can display the number of an external subscriber if it is signalled.</p> <p>The function is enabled with <i>Enabled</i>.</p> <p>The function is disabled by default.</p>
<b>Signal fixed out number</b>	<p>Only for <b>Outgoing Signalisation</b> = <i>Fixed Out DDI</i></p> <p>Enter the number that is to be displayed to the person called with any outward connection.</p>

#### Fields in the Registrar menu.

Field	Description
<b>Registrar</b>	Enter the DNS name or IP address of the SIP server. A 26 digit alpha-numeric sequence is possible.
<b>Registrar Port</b>	Enter the number of the port to be used for the connection to the server. The default value is <i>5060</i> . A 5 digit sequence is possible.
<b>Transport Protocol</b>	<p>Select the transport protocol for the connection.</p> <p>Possible values:</p> <ul style="list-style-type: none"> <li>• <i>UDP</i> (default value)</li> <li>• <i>TCP</i></li> <li>• <i>TLS</i></li> </ul>

**Fields in the STUN menu.**

Field	Description
<b>STUN server</b>	<p>Enter the name or the IP address of the STUN server.</p> <p>STUN = Simple Traversal of User Datagram Protocol (UDP) Through Network Address Translators (NATs)</p> <p>A STUN server is required to allow VoIP devices access to the internet behind an active NAT. This determines the current public IP address for the connection, which is used for precise remote addressing.</p> <p>Maximum number of characters: 32.</p>
<b>Port STUN server</b>	<p>Enter the number of the port to be used for the connection to the STUN server.</p> <p>The default value is <i>3478</i>. A 5 digit sequence is possible.</p>

**Fields in the Timer menu.**

Field	Description
<b>Registration Timer</b>	<p>Enter the time in seconds within which the SIP client must re-register to prevent the connection from disconnecting automatically.</p> <p>The default value is <i>60</i>.</p>

The menu **Advanced Settings** consists of the following fields:

**Fields in the Advanced Settings menu.**

Field	Description
<b>Proxy</b>	Enter the DNS name or IP address of the SIP server. A 26 digit alpha-numeric sequence is possible.
<b>Proxy Port</b>	Enter the number of the port to be used for the connection to the proxy. The default value is <i>5060</i> . A 5 digit sequence is possible.
<b>Transport Protocol</b>	<p>Select the transport protocol for the connection.</p> <p>Possible values:</p>

Field	Description
	<ul style="list-style-type: none"> <li>• <i>UDP</i> (default value)</li> <li>• <i>TCP</i></li> </ul>

#### Fields in the **Further Settings** menu

Field	Description
<b>From Domain</b>	Enter the SIP provider's "From Domain". It is used after the @ as sender data in the SIP header of the SIP data packages.
<b>Number of allowed simultaneous Calls</b>	<p>Select the maximum number of calls that shall be simultaneously possible Please also note the settings for bandwidth management here.</p> <p>Possible values:</p> <ul style="list-style-type: none"> <li>• <i>International</i> (default value): An unlimited number of simultaneous calls is possible.</li> <li>• <i>1</i></li> <li>• <i>2</i></li> <li>• <i>3</i></li> <li>• <i>4</i></li> <li>• <i>5</i></li> <li>• <i>10</i></li> </ul>
<b>Location</b>	<p>Select the location of the SIP server. Locations are defined in the <b>VoIP-&gt;Settings-&gt;Locations</b> menu.</p> <p>Possible values:</p> <ul style="list-style-type: none"> <li>• <i>Any Location</i> (default value): The server is not operated at any defined location.</li> <li>• <i>&lt;Location Name&gt;</i></li> </ul>
<b>Codec Profiles</b>	<p>Select the codec profile for this SIP server. Codec profiles are defined in the <b>VoIP-&gt;Settings-&gt;Codec Profiles</b> menu.</p> <p>Possible values:</p> <ul style="list-style-type: none"> <li>• <i>System Default</i> (default value): The server is operated with a codec profile predefined in the system.</li> <li>• <i>&lt;Codec profile name&gt;</i></li> </ul>

Field	Description
<b>Dial End Monitoring Time</b>	<p>Select the time in seconds (after dialling the last digit of a call number) after which the system begins external dialling. The default value is <i>5</i>.</p>
<b>Call Hold inside the PBX system</b>	<p>Select whether a telephone call in the system can be switched to hold without losing the connection (inquiry calls/brokering). If this function is not enabled, the call is held at the SIP provider, if he supports this performance feature.</p> <p>The function is activated by selecting <i>Enabled</i>.</p> <p>The function is enabled by default.</p>
<b>Call Forwarding extern (SIP 302)</b>	<p>Select whether calls are to be redirected externally with the SIP provider. The call is forwarded using SIP status code 302.</p> <p>The function is activated by selecting <i>Enabled</i>.</p> <p>The function is disabled by default.</p>
<b>Generate international phone number</b>	<p>If you enable this function and, under <b>Global Settings</b>, you have entered the <b>Country Profile</b> ( <i>49</i> for Germany), the 0049 is generated automatically in front of the number when a number with an area code is dialled.</p> <p>The function is activated by selecting <i>Enabled</i>.</p> <p>The function is disabled by default.</p>
<b>Generate national subscriber number</b>	<p>If you enable this function and, under <b>Global Settings</b>, you have entered the <b>National Prefix / City Code</b> (e.g. <i>40</i> for Hamburg), the number dialed is automatically prefixed with 040.</p> <p>The function is activated by selecting <i>Enabled</i>.</p> <p>The function is disabled by default.</p>
<b>Deactivate number suppression</b>	<p>If you enable this function, the number is always sent, independently of whether you have switched <b>Suppress outgoing CLIP (CLIR)</b> on or off for an extension.</p> <p>The function is activated by selecting <i>Enabled</i>.</p> <p>The function is disabled by default.</p>

Field	Description
	<p>If the function is disabled, you have additional options.</p> <p>In order to ensure that your system can forward anonymous calls with SIP connections you can specify in which part of the SIP header information the string "anonymous call" is transferred. The information can be transferred in multiple parts. For most providers you can simply keep the preconfigured setting <i>Privacy ID = Enabled</i>. For the service provider 1 &amp; 1 you need to additionally enable <i>Privacy Header</i>.</p> <p>Possible values:</p> <ul style="list-style-type: none"> <li>• <i>Display</i></li> <li>• <i>Users</i></li> <li>• <i>Domain</i></li> <li>• <i>Privacy Header</i></li> <li>• <i>Privacy User</i></li> <li>• <i>Privacy ID</i></li> </ul>
<b>SIP Header Field for User Name</b>	<p>Select the position of the user name (user ID) in the SIP header for outgoing calls.</p> <p>Possible values:</p> <ul style="list-style-type: none"> <li>• <i>P-Preferred</i>: The so-called "p-preferred-identity" field is added to the SIP header and contains the <b>User Name</b>.</li> <li>• <i>P-Asserted</i>: The so-called "p-asserted-identity" field is added to the SIP header and contains the <b>User Name</b>.</li> <li>• <i>None</i>: The <b>User Name</b> is not transmitted.</li> </ul>
<b>SIP Header Field(s) for Caller Address</b>	<p>Select the position of the sender ID (e.g. subscriber number) in the SIP header for outgoing calls. (For incoming calls, the subscriber number is taken automatically from the SIP header.)</p> <p>Possible values:</p> <ul style="list-style-type: none"> <li>• <i>Display</i>: The sender ID is placed in the "Display" field of the SIP header.</li> <li>• <i>User Name</i>: The sender ID is transferred to the "User" field of the SIP header.</li> <li>• <i>P-Preferred</i>: The so-called "p-preferred-identity" field is added to the SIP header to transmit the sender ID there.</li> </ul>

Field	Description
	<ul style="list-style-type: none"> <li>• <i>P-Asserted</i>: The so-called "p-asserted-identity" field is added to the SIP header to transmit the sender ID there.</li> </ul>
<b>Substitution of International Prefix with "+"</b>	<p>Select whether the prefix (e.g. 00) should be replaced by + for international numbers.</p> <p>The function is activated by selecting <i>Enabled</i>.</p> <p>The function is disabled by default.</p>
<b>PBX coupling</b>	<p>Select whether another PABX can log into your system. In this way, several PABX systems can be linked.</p> <p>The function is activated by selecting <i>Enabled</i>.</p> <p>The function is disabled by default.</p>
<b>Delete SIP bindings after Restart</b>	<p>If after registering with a provider a reset of the system should occur, for example, or a power failure, depending on the provider, another registration may prove impossible. Enabling these performance features allows re-registration after restart.</p> <p>The function is activated by selecting <i>Enabled</i>.</p> <p>The function is disabled by default.</p>
<b>Upstreaming Device with NAT</b>	<p>If you enable this function, you can use a gateway with NAT and still make VoIP calls. Without this function, it may not be possible to call you with VoIP if you use a gateway with NAT.</p> <p>The function is activated by selecting <i>Enabled</i>.</p> <p>The function is disabled by default.</p>
<b>Early media support</b>	<p>Select whether you'll allow exchange of voice and audio data before a receiver accepts a call.</p> <p>The function is enabled with <i>Enabled</i>.</p> <p>The function is enabled by default.</p>
<b>Provider without Registration</b>	<p>Select whether registration and authentication with a provider can be eliminated. In this case, the relevant data can be sent to a specific IP address already known to the correspondent. An example of this method is Microsoft Exchange SIP.</p>

Field	Description
	<p>The function is enabled with <i>Enabled</i>.</p> <p>The function is disabled by default.</p> <p>If this function is not enabled, an authentication is performed by default. For this, every SIP client (user) sends its current position to a registrar server. This information on the user and his current address is saved by the registrar on a server queried by other proxies to locate the user.</p>
<b>T.38 FAX support</b>	<p>For modular PABX systems only</p> <p>Select whether faxes shall be transmitted with T.38.</p> <p>The function is enabled with <i>Enabled</i>.</p> <p>The function is enabled by default.</p> <p>If the function is disabled, faxes are transmitted with G.711.</p>
<b>Substitution of Incoming Number Prefix</b>	<p>For incoming calls, if the call number should be forwarded in the system in modified form: in the first input field enter the sequence of the incoming number to be replaced by the number sequence entered in the second input field.</p>
<b>Send SIP UPDATE</b>	<p>This function ensures that after a call transfer the number of the new call partner is displayed for the initial calling party.</p>
	<div style="border: 1px solid gray; background-color: #f0f0f0; padding: 5px;">  <p><b>Note</b></p> <p>Note that this function is not supported by all service providers.</p> </div> <p><i>Enabled</i> activates the functions.</p> <p>The function is not enabled by default.</p>

#### Fields in the **Codec Settings** menu

Field	Description
<b>Codec Profiles</b>	<p>Select the location of the SIP server. Locations are defined in the <b>VoIP-&gt;Settings-&gt;Codec Profiles</b> menu.</p>

Field	Description
	Possible values: <ul style="list-style-type: none"> <li>• <i>System Default</i> (default value): The server is not operated at any defined location.</li> <li>• <i>&lt;Codec-Profil-Name&gt;</i></li> </ul>
<b>Video</b>	Select if calls between IP telephones are to support the transmission of video data. Video transmission can only be negotiated between the participants if both support this feature.
<b>S RTP</b>	Select if calls via this SIP provider may be secured with SRTP (Secure Real-Time Transport Protocol).

## 9.1.2 Locations

In the **VoIP->Settings->Locations** menu you configure the locations of the VoIP subscribers who have been configured on your system, and define the bandwidth management for the VoIP traffic.

Individual locations can be set up for using the bandwidth management. A location is identified from its fixed IP address or DynDNS address or from the interface to which the device is connected. The available VoIP bandwidth (up- and downstream) can be set up for each location.

Only for compact systems: A predefined entry with the parameters **Description** = *LAN*, **Parent Location** = *None*, **Type** = *Interfaces*, **Interfaces** = *LAN\_EN1-0* is displayed.

**Fields in the Registration behavior for VoIP subscribers without assigned location menu.**

Field	Description
<b>Default Behavior</b>	Specify how the system is to behave when VoIP subscribers for whom no location has been defined are being registered. <p>Possible values:</p> <ul style="list-style-type: none"> <li>• <i>Registration for Private Networks Only</i> (default value): The VoIP subscriber is only registered if they are within the private network.</li> <li>• <i>No Registration</i>: The VoIP subscriber is never registered.</li> <li>• <i>Unrestricted Registration</i>: The VoIP subscriber is always registered.</li> </ul>



### 9.1.2.1 Edit or New

Choose the  icon to edit existing entries. Select the **New** button to create new entries.

The menu **VoIP->Settings->Locations->New** consists of the following fields:

#### Fields in the **Basic Settings** menu.

Field	Description
<b>Description</b>	Enter the description of the entry.
<b>Parent Location</b>	You can cascade the SIP locations as you wish. Define here which SIP location that has been defined constitutes the high-level node for the SIP location to be configured here.
<b>Type</b>	Select whether the location is to be defined through IP addresses/DNS names or interfaces.  Possible values: <ul style="list-style-type: none"> <li>• <i>Addresses</i> (default value): The SIP location is defined via IP addresses or DNS names.</li> <li>• <i>Interfaces</i>: The SIP location is defined via the available interfaces.</li> </ul>
<b>Addresses</b>	Only for <b>Type</b> = <i>Addresses</i>  Enter the IP addresses of the devices at the SIP locations.  Click <b>Add</b> to configure new addresses.  Enter the IP address or DNS name that you want under <b>IP Address/DNS Name</b> .  Also enter the required <b>Netmask</b> .
<b>Interfaces</b>	Only for <b>Type</b> = <i>Interfaces</i>  Indicate the interfaces to which the devices of a SIP location are connected.  Click <b>Add</b> to select a new interface.  Under <b>Interface</b> , select the interface you want.

Field	Description
<b>Upstream Bandwidth Limitation</b>	Determine whether the upstream bandwidth is to be restricted.  The bandwidth is reduced with <i>Enabled</i> .  The function is disabled by default.
<b>Maximum Upstream Bandwidth</b>	Enter the maximum data rate in the send direction in kBits per second.
<b>Downstream Bandwidth Limitation</b>	Determine whether the downstream bandwidth is to be restricted.  The bandwidth is reduced with <i>Enabled</i> .  The function is disabled by default.
<b>Maximum Downstream Bandwidth</b>	Enter the maximum data rate in the receive direction in kBits per second.

The menu **Advanced Settings** consists of the following fields:

#### Fields in the **Advanced Settings** menu.

Field	Description
<b>DSCP Settings for rtp Traffic</b>	Select the Type of Service (TOS) for RTP data.  Possible values: <ul style="list-style-type: none"> <li>• <i>DSCP Binary Value</i> (default value): Differentiated Services Code Point according to RFC 3260 is used to signal the priority of IP packets (indicated in binary format, 6 bit). The preconfigured value is <i>101110</i>.</li> <li>• <i>DSCP Decimal Value</i>: Differentiated Services Code Point according to RFC 3260 is used to signal the priority of IP packets (indicated in decimal format).</li> <li>• <i>DSCP Hexadecimal Value</i>: Differentiated Services Code Point according to RFC 3260 is used to signal the priority of IP packets (indicated in hexadecimal format).</li> <li>• <i>TOS Binary Value</i>: The TOS value is specified in binary format, e.g. 00111111.</li> <li>• <i>TOS Decimal Value</i>: The TOS value is specified in decimal format, e.g. 63.</li> </ul>

Field	Description
	<ul style="list-style-type: none"> <li>• <i>TOS Hexadecimal Value</i>: The TOS value is specified in hexadecimal format, e.g. 3F.</li> </ul>

### 9.1.3 Codec Profiles

In the **VoIP->Settings->Codec Profiles**, you can define the various codec profiles to control voice quality and set up specific provider-dependent default settings.

When setting up the codec, remember that a good voice quality requires a corresponding bandwidth so that the number of simultaneous calls will be restricted. The remote terminal also has to support the relevant codec choice.

#### 9.1.3.1 Edit or New

Choose the  icon to edit existing entries. Select the **New** button to create new entries.

The menu **VoIP->Settings->Codec Profiles->New** consists of the following fields:

#### Fields in the **Basic Parameters** menu.

Field	Description
<b>Description</b>	Enter a description for the entry.
<b>Codec Proposal Sequence</b>	<p>Choose the order in which the codecs are offered for use by the system. If the first codec cannot be used, the second is tried and so on.</p> <p>Possible values:</p> <ul style="list-style-type: none"> <li>• <i>Default</i> (default value): the codec in the first position in the menu will be used if possible.</li> <li>• <i>Quality</i>: The codecs are sorted by quality. The codec with the best quality is used if possible.</li> <li>• <i>Low Bandwidth</i>: The codecs are sorted by required bandwidth. If possible, the codec with the lowest bandwidth requirement is used.</li> <li>• <i>High Bandwidth</i>: The codecs are sorted by required bandwidth. If possible, the codec with the highest bandwidth requirement is used.</li> </ul>
<b>G.711 uLaw</b>	Only for <b>Codec Proposal Sequence</b> not <i>default</i>

Field	Description
	<p>ISDN codec with US characteristic</p> <p>G.711 uLaw passes audio signals in the range of 300-3500 Hz and samples them at the rate of 8,000 samples per second. At 64 kbit/s bit rate the mean opinion score (MOS) is 4,4. This audio codec uses <math>\mu</math>law quantization.</p>
<b>G.711 aLaw</b>	<p>Only for <b>Codec Proposal Sequence</b> not <i>default</i></p> <p>ISDN codec with EU characteristic</p> <p>G.711 aLaw passes audio signals in the range of 300-3400 Hz and samples them at the rate of 8,000 samples per second. At 64 kbit/s bit rate the mean opinion score (MOS) is 4,4. This audio codec uses alaw quantization.</p>
<b>G.722</b>	<p>Only for <b>Codec Proposal Sequence</b> not <i>default</i></p> <p>G.722 passes audio signals in the range of 50-7000 Hz and samples them at the rate of 16,000 samples per second. At 64 kbit/s bit rate the mean opinion score (MOS) is 4,5.</p>
<b>G.729</b>	<p>Only for <b>Codec Proposal Sequence</b> not <i>default</i></p> <p>G.729 passes audio signals in the range of 300-2400 Hz and samples them at the rate of 8,000 samples per second. At 8 kbit/s bit rate the mean opinion score (MOS) is 3,9.</p>
<b>G.726 (16 kbit/s)</b>	<p>Only for <b>Codec Proposal Sequence</b> not <i>default</i></p> <p>G.726 (16 kbit/s) passes audio signals in the range of 200-3400 Hz and samples them at the rate of 8,000 samples per second. At 16 kbit/s bit rate the mean opinion score (MOS) is 3,7.</p>
<b>G.726 (24 kbit/s)</b>	<p>Only for <b>Codec Proposal Sequence</b> not <i>default</i></p> <p>G.726 (24 kbit/s) passes audio signals in the range of 200-3400 Hz and samples them at the rate of 8,000 samples per second. At 24 kbit/s bit rate the mean opinion score (MOS) is 3,8.</p>
<b>G.726 (32 kbit/s)</b>	<p>Only for <b>Codec Proposal Sequence</b> not <i>default</i></p> <p>G.726 (32 kbit/s) passes audio signals in the range of 200-3400 Hz and samples them at the rate of 8,000 samples per second.</p>

Field	Description
	At 32 kbit/s bit rate the mean opinion score (MOS) is 3,9.
<b>G.726 (40 kbit/s)</b>	Only for <b>Codec Proposal Sequence</b> not <i>default</i>  G.726 (40 kbit/s) passes audio signals in the range of 200-3400 Hz and samples them at the rate of 8,000 samples per second. At 40 kbit/s bit rate the mean opinion score (MOS) is 4,2.
<b>DTMF</b>	Only for <b>Codec Proposal Sequence</b> not <i>default</i>  Select whether the DTMF Outband codec is to be used. First the system attempts to use RFC 2833. If the remote terminal does not use this standard, SIP Info is used.  The function is activated by selecting <i>Enabled</i> .  The function is enabled by default.
<b>G.726 Codec settings</b>	Only for <b>Codec Proposal Sequence</b> not <i>default</i>  Select the coding method for the G.726 codec.  Possible values:  <ul style="list-style-type: none"> <li>• <i>I.366</i></li> <li>• <i>RFC3551 / X.420</i></li> </ul>

## 9.1.4 Options

In the **VoIP->Settings->Options** menu, you'll find general VoIP settings.

The **VoIP->Settings->Options** menu consists of the following fields:

### Fields in the **Basic Settings** menu.

Field	Description
<b>RTP Port</b>	Enter the port via which the RTP data is to be transported.  The default value is <i>10000</i> .
<b>Client Registration Timer</b>	Here, enter a default value for the time in seconds within which the SIP clients must re-register to prevent the connection from disconnecting automatically.

Field	Description
	The default value is <i>60</i> .

The menu **Advanced Settings** consists of the following fields:

#### Fields in the **Advanced Settings** menu.

Field	Description
<b>DSCP Settings for sip Traffic</b>	<p>Select the Type of Service (TOS) for SIP data.</p> <p>Possible values:</p> <ul style="list-style-type: none"> <li>• <i>DSCP Binary Value</i> (default value): Differentiated Services Code Point according to RFC 3260 is used to signal the priority of IP packets (indicated in binary format, 6 bit). The default value is <i>101110</i>.</li> <li>• <i>DSCP Decimal Value</i>: Differentiated Services Code Point according to RFC 3260 is used to signal the priority of IP packets (indicated in decimal format).</li> <li>• <i>DSCP Hexadecimal Value</i>: Differentiated Services Code Point according to RFC 3260 is used to signal the priority of IP packets (indicated in hexadecimal format).</li> <li>• <i>TOS Binary Value</i>: The TOS value is specified in binary format, e.g. <i>00111111</i>.</li> <li>• <i>TOS Decimal Value</i>: The TOS value is specified in decimal format, e.g. <i>63</i>.</li> <li>• <i>TOS Hexadecimal Value</i>: The TOS value is specified in hexadecimal format, e.g. <i>3F</i>.</li> </ul>
<b>SIP Port</b>	<p>Specify the port SIP data are to be transferred through.</p> <p>The default value is <i>5060</i>.</p>
	<p> <b>Note</b></p> <p>If you change the port during operation, the change only becomes effective after the next reboot of your device.</p>
<b>Client Subscription Timer</b>	<p>Enter a value for the amount of time in seconds after which a SIP client must have re-registered all its configured busy lamp field keys in order for the status information not to get lost.</p>

Field	Description
	<p>The default value is <i>300</i>.</p> <p>You can usually keep the default value, but in case you have many keys configured, it may be a good idea to increase it.</p>

#### Fields in the SIP over TLS menu

Field	Description
<b>Local Certificate</b>	<p>You can select a certificate for the use with SIP over TLS.</p> <p>The default certificate is the internal certificate of your device.</p>

## Chapter 10 Numbering

### 10.1 Trunk Settings

Your system is a telecommunication installation for external connection to the Euro ISDN (DSS1) and the Internet:

ISDN connections (S0): Depending on module extension, the system features external ISDN connections (if supported by you device) configured for connection to the network operator's ISDN connection. Depending on module extension, several ISDN connections can either be set as an internal or external ISDN connection.

#### 10.1.1 Trunks

In the menu **Numbering->Trunk Settings->Trunks** you can see the configured external connections of your system. External connections are configured in the menu **VoIP->Settings->SIP Provider** or through the respective configuration assistant.



#### Note

Pure IP devices do not support the creation of new entries.

#### Values in the Trunks list

Field	Description
Nr.	Shows the sequential number of the connection.
Description	Shows the description of the connection you have configured.
External Port	Shows the port this external connections is connected to.

#### 10.1.1.1 Edit or New

Choose the  icon to edit existing entries. Choose the **New** button to create new connections.

The **Numbering->Trunk Settings->Trunks->New** menu consists of the following fields:

#### Fields in the Basic Settings menu



Field	Description
<b>Description</b>	You can enter a designation for the connection you selected.
<b>Access Type</b>	<p>Displays the connection type that has been configured.</p> <p>Possible values:</p> <ul style="list-style-type: none"> <li>• <i>ISDN P-MP</i></li> <li>• <i>ISDN P-P</i></li> <li>• <i>FXO</i></li> </ul>
<b>Port</b>	<p>Only for <b>Access Type</b> = <i>ISDN P-MP</i> or <i>FXO</i></p> <p>Select the description for the port via which this external connection is made.</p>
<b>Ports</b>	<p>Only for <b>Access Type</b> = <i>ISDN P-P</i></p> <p>Select the description for the port via which this external connection is made.</p> <p>All free external ISDN interfaces are available.</p> <p>Select additional ports with the <b>Add</b> button, e.g. to configure a party line.</p>

#### Fields in the **Outgoing Signalisation Settings** menu

Field	Description
<b>Outgoing Signalisation</b>	<p>Select the signalling you want for outgoing calls.</p> <p>Possible values:</p> <ul style="list-style-type: none"> <li>• <i>Standard</i> (default value)</li> <li>• <i>Global CLIP no Screening Number</i></li> <li>• <i>Individual CLIP no Screening Number</i></li> <li>• <i>Fixed Out DDI</i></li> </ul>
<b>Global CLIP no Screening Number</b>	<p>Only for <b>Outgoing Signalisation</b> = <i>Global CLIP no Screening Number</i></p> <p>Here you can enter a number that is to be displayed to the called party for all external connections.</p>

Field	Description
	This number is not checked.
<b>Signal remote caller number</b>	<p>Only for <b>Outgoing Signalisation</b> = <i>Global CLIP no Screening Number</i> and <i>Individual CLIP no Screening Number</i></p> <p>You can have the number of an external party shown if it is being signalled.</p> <p>The function is enabled with <i>Enabled</i>.</p> <p>The function is disabled by default.</p>
<b>Signal fixed out number</b>	<p>Only for <b>Outgoing Signalisation</b> = <i>Fixed Out DDI</i></p> <p>For all calls "to the outside world" you can have a number displayed, e. g. your switchboard's number.</p>

The menu **Advanced Settings** consists of the following fields:

#### Fields in the **Advanced Settings** menu

Field	Description
<b>Type of Number</b>	<p>Select the number type for outgoing calls.</p> <p>Possible values:</p> <ul style="list-style-type: none"> <li>• <i>System Setting</i>: The standard system setting (country setting) is used.</li> <li>• <i>Unknown</i>: Select this setting if the number type "unknown" is to be signalled.</li> <li>• <i>Subscriber</i>: This is an extension number.</li> <li>• <i>National</i>: This is a national number (area code + extension number).</li> </ul>
<b>Call Hold inside the PBX system</b>	<p>Select whether a telephone call is to be put on hold in the system without losing the connection.</p> <p>The function is activated by selecting <i>Enabled</i>.</p> <p>The function is disabled by default.</p>

## 10.1.2 Trunk Numbers

In the menu **Numbering->Trunk Settings->Trunk Numbers** you assign the external numbers and the name indicated in a system telephone display to the external connections you've defined.

An external connection can be configured as a point-to-multipoint or point-to-point connection; in the process, the connection description is defined. The intended port name is then assigned to this connection. The port name (**Description**) can be defined under **Physical Interfaces->ISDN Ports->ISDN External** for the module connection.

### External numbers at the point-to-point connection

For a point-to-point connection, you receive a PBX number together with a 1-, 2-, 3- or 4-character extension number range. This extension number range comprises the direct dial-in numbers for the PBX connection. If you've requested several point-to-point connections, the number of extensions can be expanded, or you receive another PBX number with your own extension number range.

With a point-to-point connection, external calls are signalled to the subscriber whose assigned internal number corresponds to the dialled extension number. You configure the internal numbers to be reached directly via direct dial-in of the extension numbers as **Internal Number** in the menu **Numbering->User Settings->User->Add->Trunk Numbers->Internal Numbers**.

Example: You have a point-to-point connection with the PBX number *1234* and extension numbers from *0* to *30*. A call under *1234-22* is normally signalled at the internal subscriber with call number *22*. However, if you enter extension number *22* in this list, you can define that calls under *1234-22* are signalled at the internal subscriber by call number *321*.

### External subscriber numbers at point-to-multipoint connection

For a point-to-multipoint connection, you can request up to 10 numbers (MSN, multiple subscriber number) per ISDN connection. These MSNs are the external subscriber numbers for your ISDN connections. Definition of the internal number occurs under **Numbering->User Settings->User->Add->Trunk Numbers**.

#### 10.1.2.1 Edit or New

Choose the  icon to edit existing entries. Choose the **New** button to create new numbers.

The **Numbering->Trunk Settings->Trunk Numbers->New** menu consists of the following fields:

#### Fields in the **Basic Settings** menu.

Field	Description
<b>Trunk</b>	Select the connection defined in <b>Numbering-&gt;Trunk Settings-&gt;Trunks</b> for which to perform the number configuration.
<b>Type of Number</b>	Select the call number type to be defined according to connection type.  Possible values: <ul style="list-style-type: none"> <li>• <i>Single Number (MSN)</i>: Only for point-to-multipoint connections.</li> <li>• <i>P-P Base Number</i>: Only for point-to-point connections.</li> <li>• <i>P-P DDI Exception</i>: Only for point-to-point connections.</li> <li>• <i>P-P Additional MSN</i>: Only for point-to-point connections.</li> </ul>
<b>Displayed Name</b>	In general, you enter the name to be displayed for this number in the called system telephone's display.  Für <b>Type of Number</b> = <i>P-P Base Number</i> this field displays the name of the connection.
<b>Single Number (MSN)</b>	Here, enter the MSN for a point-to-multipoint connection.
<b>P-P Base Number</b>	Here, enter the number for the point-to-point connection (without direct dial number).
<b>P-P DDI Exception</b>	Here, enter the direct dial exception for a point-to-point connection.  Note: Only enter the extension according to your extension number range that should be routed to differing internal subscriber numbers. Direct dial at the point-to-point connection always proceeds to the subscriber whose number was dialled along as extension. E. g. the internal subscriber has the number 16. If this subscriber is called from outside on 1234567-16, the call is signalled at his telephone. However, if with direct dial 16 a subscriber with the number 888 is to be called, enter 888 as the exception number. In <b>Incoming Distribution</b> you then assign the exception number to the subscriber with the number 16. You can subsequently perform additional settings in

Field	Description
	<b>Incoming Distribution.</b>
<b>P-P Additional MSN</b>	<p>Here, enter an additional MSN for a point-to-point connection.</p> <p>With some providers, it's possible to also transmit a point-to-multipoint number on a point-to-point connection in parallel to the direct dial number; e.g. a fax number pre-existing setup of a point-to-point connection, or the old point-to-multipoint number.</p>

### 10.1.3 Trunk Groups

In the **Numbering->Trunk Settings->Trunk Groups** menu, you can group the various external connections and individually provide these to the users.

You wish to assign specific external connections to internal subscribers for outgoing connections. You can join these external connections together to create bundles and supply these to extensions for outgoing calls. In this way, all extensions start external dialling with the same dialling code, but can only establish a connection using the bundle released for the extension in question.

The external connections of your system can be grouped into bundles. You can configure up to 99 bundles (01 - 99). The code number for bundle assignment can be modified (menu **Alternative Access Codes**).

When initiating an external call through the bundle code number, the bundle cleared for the subscriber is used in connection setup.

Only for compact systems: A predefined entry with the parameters **Description** = *ISDN External* and **Sequence in Trunk Group** = *ISDN External* is displayed.

#### 10.1.3.1 Edit or New

Choose the  icon to edit existing entries. Select the **New** button to create a new bundle.

The **Numbering->Trunk Settings->Trunk Group->New** menu consists of the following fields:

**Fields in the Basic Settings menu.**

Field	Description
<b>Description</b>	<p>Enter a description for the entry.</p> <p>The default value is <i>ISDN Extern.</i></p>

Field	Description
<b>Sequence in Trunk Group</b>	<p>Select the desired external connections for a bundle. The order when dialling to the outside matches the sequence of external connections in this list.</p> <p>You wish to assign specific external connections for outgoing connections to the internal subscribers of your system. You can group external connections into bundles and provide these to subscribers for the outgoing dialling. In this way, all subscribers initiate the external dialling with same bundle access code, but can only set up a connection over the bundles for which they have been cleared.</p>

## 10.1.4 X.31

### Packet-switched data transmission (X.31)

To improve customer service, you wish to allow cashless payment methods such as debit or credit card, or record purchase data for a customer card. For this purpose, you connect a data device to your system, which transmits data for customers and credit cards to a central location.

You can connect a data device which operates according to the X.31 transmission standard (data transmission over the D channel) to the system's internal ISDN connections. These are, for example, checkout terminals, cashpoints or customer card terminals.

For use of these performance features, your network operator provides you TEI's (Terminal Endpoint Identifier), which you assign to individual connections when configuring your system. An additional addressing of these terminals occurs via these TEI's.



#### Note

You can only use this performance feature if performance feature **X.31** has been requested from the network operator, and you operate a corresponding terminal on this connection. For information on operation, please see the user's guide for your terminals.

#### 10.1.4.1 Edit or New

Choose the  icon to edit existing entries. Select the **New** button to set up new X.31 applications.

The **Numbering->Trunk Settings->X.31->New** menu consists of the following fields:

#### Fields in the **Basic Settings** menu.

Field	Description
<b>Select Interface</b>	Select the external interface over which you access the network operator providing you performance feature X.31.
<b>Terminal Endpoint Identifier (TEI)</b>	Here, select the TEI value (TEI, Terminal Endpoint Identifier) which you have received from your network operator. An additional addressing of these terminals occurs via the TEI's.  Possible values are <i>00</i> to <i>63</i> . The default value is <i>00</i> .
<b>Internal Assignment</b>	Select the internal ISDN interface to which your data device, which operates according to the X.31 transmission standard (data transmission over the D channel), is connected.

## 10.2 User Settings

In this menu, you configure and administer your system's users. The users are organised into authorisation classes to which the desired external lines are assigned, and which may use performance features according to request. The user assigned to an authorisation class receives an internal number and specific authorisations. A default authorisation class (Default CoS) is preset ex-works, to which new users are automatically assigned.

After it's been defined in User Settings which functions and authorisations a user, or several users, have access to, authorisation of user settings is assigned to a terminal in menu **Terminals**. In this way, it's possible to create settings for several terminals via an authorisation class, e. g. a user setting *Boss*, a user setting *Department Head* and a user setting *Clerk*. Now, all that's left to do is assign the corresponding terminals to one of these **Class of Service**.

### 10.2.1 Users

In the **Numbering->User Settings->Users** you configure the users of your system, their class, and assign them internal and external numbers.

You see an overview of the users that have been created. The entries in the **Name** column are sorted alphabetically. Click the column title of any other column to sort entries in ascending or descending order

Only for compact systems: The following users are predefined:

- *User 1 to User 4 analog Tel*
- *User 5 and User 6 Sys Tel*
- *User 7 DECT*
- *User 8 and User 9 ISDN*

Choose the  icon to edit existing entries. Select the **New** button in order to create new users.

### 10.2.1.1 Basic Settings

Enter basic user information in the **Numbering->User Settings->Users->Basic Settings** menu.

The **Numbering->User Settings->Users->Basic Settings** menu consists of the following fields:

#### Fields in the Basic Settings menu.

Field	Description
<b>Name</b>	Enter the name of the user.  This name is displayed in the phone book if you have entered a number and cleared it for the phone book under <b>Mobile Number Home Number</b> . The name is displayed with the codes (M) for mobile communication, and (H) for home number in the system telephone display.
<b>Description</b>	Enter additional user information.

#### Fields in the External Numbers menu.

Field	Description
<b>Mobile Number</b>	Enter a number under which the user can be reached via mobile phone. Also select whether this number is to be shown in the system telephone display so that it can be dialled on the system telephone from the system phone book ( <b>Access from system phone</b> option).
<b>Home Number</b>	Enter a number under which the user can be reached privately. Also select whether this number is to be shown in the system telephone display so that it can be dialled on the system tele-



Field	Description
	phone from the system phone book ( <b>Access from system phone</b> option).
<b>E-mail Address</b>	Enter the e-mail address for the user.

#### Fields in the **Class of Service** menu.

Field	Description
<b>Standard</b>	<p>Select the authorisation class = CoS (Class of Service). Definition of the authorisation class and creation of new authorisation classes occurs under <b>Numbering-&gt;User Settings-&gt;Class of Services</b>. Only selection occurs in this setting.</p> <p>Possible values:</p> <ul style="list-style-type: none"> <li>• <i>Default CoS</i> (default value)</li> <li>• <i>Not allowed</i>: No class of service</li> <li>• <i>&lt;Authorisation class&gt;</i></li> </ul>
<b>Optional</b>	<p>Select an optional authorisation class. This CoS is required for the calendar settings. Definition of the authorisation class and creation of new authorisation classes occurs under <b>Numbering-&gt;User Settings-&gt;Class of Services</b>. Only selection occurs in this setting.</p> <p>Possible values:</p> <ul style="list-style-type: none"> <li>• <i>Default CoS</i> (default value)</li> <li>• <i>Not allowed</i>: No class of service</li> <li>• <i>&lt;Authorisation class&gt;</i></li> </ul>
<b>Night</b>	<p>Select the authorisation class for night operation. This CoS is required for the calendar settings. Definition of the authorisation class and creation of new authorisation classes occurs under <b>Numbering-&gt;User Settings-&gt;Class of Services</b>. Only selection occurs in this setting.</p> <p>Possible values:</p> <ul style="list-style-type: none"> <li>• <i>Default CoS</i> (default value)</li> <li>• <i>Not allowed</i>: No class of service</li> <li>• <i>&lt;Authorisation class&gt;</i></li> </ul>

### Fields in the Further Options menu.

Field	Description
<b>Busy on busy</b>	<p>Select whether the performance feature "Busy on Busy" shall be enabled for this user.</p> <p>If a subscriber for whom multiple telephone numbers have been configured makes a call, you can decide whether additional calls for this user shall be signalled. If "Busy on Busy" is set for this user, other callers get an <b>Engaged</b> signal if the user is calling on one of her numbers.</p> <p>The function is activated by selecting <i>Enabled</i>.</p> <p>The function is disabled by default.</p>

### 10.2.1.2 Numbers

In the menu **Numbering->User Settings->Users->Numbers** internal numbers which are later assigned to the terminals can be entered. Depending on the type, one or more numbers can be assigned per terminal.

The **Numbering->User Settings->Users->Numbers** menu consists of the following fields:

### Fields in the Internal Numbers menu.

Field	Description
<b>Internal Numbers</b>	<p>Enter the internal numbers for the user and the description to be shown in the system telephone display (<b>Displayed Description</b>). In addition, select whether this internal number shall be displayed in the <b>System Phonebook</b>, and whether the LED next to the corresponding function key (<b>Busy Lamp Field</b>) should light up.</p> <p>The functions are activated by default.</p> <p>Add new <b>Internal Numbers</b> with <b>Add</b>.</p> <p>Only for compact systems: Users with the internal numbers <i>10, 11, 12, 13, 20, 21, 22, 30</i> and <i>35</i> are predefined.</p>

### 10.2.1.3 Outgoing Signalisation

In the **Numbering->User Settings->Users->Outgoing Signalisation** menu, select the outgoing numbers for the user.

For an outgoing call, if the remote subscriber should not see the number assigned to your own connection, one of the existing numbers can be selected here for display. If no number is defined, the system transmits no number to the provider.

#### Fields in the list Outgoing Signalisation

Field	Description
<b>Internal Number</b>	Displays the internal numbers configured for the user.
<b>Displayed Description</b>	Displays, for each internal number, the description configured for the system telephone display.
<b>Outgoing Signalisation</b>	<p>Select the signal you want for outgoing calls.</p> <p>Possible values:</p> <ul style="list-style-type: none"> <li>• <i>Default, own DDI Signalling</i>: The user's own extension is used as the <b>Outgoing Signalisation</b>. This option is available when there is a point-to-point configuration or a SIP provider with direct dialling.</li> <li>• <i>Standard</i>: No <b>Outgoing Signalisation</b> is sent. In this case, the switchboard uses the port's main number.</li> <li>• <i>&lt;Fixed phone number&gt;</i>: For a FXO port, the phone number configured is already assigned as the <b>Outgoing Signalisation</b> and is displayed.</li> <li>• <i>&lt;Phone number&gt;</i>: When more than one number has been configured, you can select a number that you wish to use as the <b>Outgoing Signalisation</b>.</li> </ul>

Select the  icon to specify for each internal number (indicated in the table by **Internal Number** and **Displayed Description**) which number shall be displayed for outgoing calls. Here, for each configured external connection, select one of the numbers configured for this purpose.

If more than one external connection has been configured, you can specify the procedure for outgoing calls. When an external line is engaged, the order of the entries determines the sequence in which the other lines assigned will be used to dial.

The configured **Outgoing Signalisation** can be hidden for each outgoing line; to do so, put a tick under **Hide Number** in the relevant row.

If you wish to move an entry in the list displayed, select the  icon in the relevant row. A new window opens.

The selected entry is displayed under **External Connection**, here e. g. *ISDN\_1*.

Proceed as follows to move the selected entry:

- (1) Under **Move**, select in the list the entry relative to which you wish to move the selected entry, here e. g. *1.SIP-Provider\_1*.
- (2) Select whether you want to insert the entry *above* or *below* the selected entry in the list, here e. g. *above*.
- (3) Select **Copy**.  
The entries display in the changed order.
- (4) If the list contains more than two entries, move other entries if you wish.

The sequence configured here overwrites the setting that is assigned by the permission class. However, the assigned permission class continues to determine whether a user has access to a particular external connection.

### 10.2.1.4 Optional Rerouting

In the **Numbering->User Settings->Users->Optional Rerouting** menu, to each displayed subscriber internal number you can assign a **Redirect application** and a **Active Variant (Day)**.

Here, for example, you can define to which co-worker calls shall be forwarded when you're in a conference, or whether the head office is responsible for taking calls during lunch.

#### Fields in the **Optional Rerouting** menu.

Field	Description
<b>Internal Number</b>	Displays the internal numbers configured for the user.
<b>Displayed Description</b>	Displays, for each internal number, the description configured for the system telephone display.
<b>Rerouting Application</b>	Select from the dropdown list the desired redirect application that you wish to assign to the internal number. You may choose from the redirect applications that you've configured in the <b>Applications-&gt;Rerouting-&gt;Rerouting Applications-&gt;New</b> menu

Field	Description
	<p>with <b>Type of redirect application</b> = <i>Internal Subscriber</i> .</p> <p>Possible values:</p> <ul style="list-style-type: none"> <li>• <i>None</i> (default value)</li> <li>• &lt;Redirect application&gt;</li> </ul>
<b>Active Variant (Day)</b>	<p>Select the redirect application variant to be currently enabled. If a variant switch is set up via the calendar, this setting will be switched back again at the appropriate time.</p> <p>Possible values:</p> <ul style="list-style-type: none"> <li>• <i>Variant</i></li> <li>• <i>Variant 2</i></li> <li>• <i>Variant 3</i></li> <li>• <i>Variant 4</i></li> </ul>

### 10.2.1.5 Authorizations

In the menu **Numbering->User Settings->Users->Authorizations** you can allow this user to make certain settings himself via HTML configuration. For this, a user name and password must be entered in the user HTML configuration, and personal access authorised. Once logged out, you can view and modify the corresponding settings after entering this user name and password.

The **Numbering->User Settings->Users->Authorizations** menu consists of the following fields:

#### Fields in the Basic Settings menu.

Field	Description
<b>Password for IP Phone Registration</b>	<p>Enter the password with which a user IP telephone must log into the system.</p> <p>The password can remain free if IP telephones log in but need not authenticate themselves.</p>
<b>PIN for Phone Access</b>	<p>Here you can change the PIN for the user's personal answering machine (voicemail box). The default value is <i>none</i>.</p>

#### Fields in the User HTML Configuration menu.

Field	Description
<b>Personal Access</b>	<p>Select whether this user shall receive access authorisation to a personalised user interface (user access) where he can perform his own entries and settings.</p> <p>The function is activated by selecting <i>Enabled</i>.</p> <p>The function is disabled by default.</p>
<b>Login Name</b>	<p>Only for <b>Personal Access</b> enabled.</p> <p>Enter a user name for this user. This is required for login on the user interface.</p>
<b>Password</b>	<p>Only for <b>Personal Access</b> enabled.</p> <p>Enter a password for this user. This is required for login on the user interface.</p>

### Call Through

Call Through consists in dialin to the system via an external connection and the call put through from the system via another external connection.



#### Note

In the connection data records, one data record is created for the incoming connection and one for the outgoing connection.

#### Fields in the Further Options menu.

Field	Description
<b>Call Through</b>	<p>Select whether Call Through should be authorised for this user.</p> <p>The function is activated by selecting <i>Enabled</i>.</p> <p>The function is disabled by default.</p> <p>When you enable the function, you must select under <b>Use routing and signalisation from number</b> the internal number from which the authorised external lines and call options for Call Through shall be used.</p>

## 10.2.2 Class of Services

In the **Numbering->User Settings->Class of Services** (CoS) the functions and performance features for the user settings are defined. These authorisation classes can then be assigned to individual users (user groups) in the user settings.

Choose the  icon to edit existing entries. Choose the **New** button to create additional authorisation classes. The authorisation class *CoS Default* is configured by default.

### 10.2.2.1 Basic Settings

In the menu **Numbering->User Settings->Class of Services->Basic Settings**, the basic settings along with the name for the new authorisation class are defined. The authorisation class can be located via the name.

The **Numbering->User Settings->Class of Services->Basic Settings** menu consists of the following fields:

#### Fields in the Basic Settings menu.

Field	Description
Description	Enter a description for the entry.

#### Fields in the Line Access Authorization menu.

Field	Description
Line Access Authorization	<p>Select line access authorisation for the authorisation class.</p> <p>Line access authorisation determines which calls (internal, external,...) are allowed. The system distinguishes several authorisation levels.</p> <p>Possible values:</p> <ul style="list-style-type: none"> <li>• <b>Unlimited:</b> The telephones have unrestricted dialling authorisations and can initiate all connections.</li> <li>• <i>National:</i> The telephones can initiate all calls except international calls. If a number starts with the code for international dialling, the number cannot be dialled.</li> <li>• <i>Incoming:</i> The telephones can receive incoming external calls, but cannot initiate any external calls. Internal calls are possible.</li> <li>• <i>Region:</i> The telephones cannot make any national or inter-</li> </ul>

Field	Description
	<p>national calls. For this dial permission, 10 exception numbers allowing national or international dialling can be configured. An exception number can consist of complete call numbers or sections thereof (e. g. the first numerals).</p> <ul style="list-style-type: none"> <li>• <i>Local</i>: The telephones can make local calls. National and international calls are not possible.</li> <li>• <i>Internal</i>: The telephones do not have authorisation for incoming or outgoing external calls. Only internal telephone calls are possible.</li> </ul>
<p><b>Automatic Outside Line</b></p>	<p>This setting defines whether automatic outside line is set up for this authorisation class. With automatic outside line, users of this authorisation class hear the external dialling tone after picking up the receiver and can immediately dial outside. To make internal calls, press the star key after picking up the receiver.</p> <p>If you have set up an automatic outside line for an internal subscriber, the keypad functions cannot be directly used. First disable the <b>Automatic Outside Line</b> or dial the star key, then the code for manual outside line (e. g. 0) followed by keypad dialling, beginning with the star or hash key.</p>
<p><b>Trunk Line Selection with Line Access Number</b></p>	<p>Select the connections over which outgoing calls from these telephones shall be externally routed. The order of entries determines in which sequence, in case of an engaged external line, dialling shall occur over the other assigned lines</p>
<p><b>Allow manual trunk group selection</b></p>	<p>Besides general exchange access, a telephone can also selectively use a bundle. Here an external connection is initiated with the corresponding code for the target assignment of the bundle and not by dialling the dialling code.</p> <p>To be able to perform a selective bundle assignment, the authorisation class must possess the appropriate authorisation. The authorisation can also include bundles that the authorisation class can otherwise not assign. If a telephone does not possess the authorisation for selective bundle assignment, or if the selected bundle is in use, the busy tone is heard after dialling the code. If <b>Automatic outside line</b> is set up for an authorisation class, users of this authorisation class must press the star key before selective bundle assignment, then initiate external dialling with the code for bundle assignment.</p>



Field	Description
	<p>The function is activated by selecting <i>Enabled</i>.</p> <p>The function is disabled by default.</p> <p>Then select the bundles for which manual bundle assignment is to be allowed. You can configure bundles in the <b>Numbering-&gt;Trunk Settings-&gt;Trunk Groups</b> menu.</p>

### Number display

If you call a subscriber, your number is displayed to him. The person you're calling thus sees that you are calling even before picking up the receiver. If you don't want the person you're calling to see your number before picking up the receiver, you can prevent display of your number to your called party.

If your called party has set up call forwarding, you won't know at which telephone you've reached him. In this case, you can display the number to which your called party has forwarded the call. However, the person you're calling also has the option of preventing display of this number.

Call number display allows display of the caller's number already at call signaling, even on analogue telephones. Thus, you know who wishes to speak to you even before you've accepted the call.



### Note

Transmission of analogue CLIP data can be set up separately for every analogue connection. Please refer to the users' guides for your analogue terminals to determine whether these support the "CLIP" and "CLIP off Hook" performance features.

Not all described performance features are included in the ISDN standard connection. Please inquire of your network operator the extent to which individual performance features must be separately ordered for your ISDN connection.

The menu **Advanced Settings** consists of the following fields:

### Fields in the Further Settings menu.

Field	Description
<b>Dial Control</b>	Select whether numbers entered in the <b>Call Routing-&gt;Outgoing Services-&gt;Dial Control</b> menu shall be allowed or denied also for this authorisation class.

Field	Description
	<p>The function is activated by selecting <i>Enabled</i>.</p> <p>The function is disabled by default.</p>
<b>Automatic Route Selection (ARS)</b>	<p>Select whether the routing rules entered in the <b>Call Routing-&gt;Automatic Route Selection</b> menu shall also be applied to this authorisation class.</p> <p>The function is activated by selecting <i>Enabled</i>.</p> <p>The function is disabled by default.</p>
<b>Show Outgoing Number (CLIP)</b>	<p>Select whether the caller number shall be displayed to the called party.</p> <p>The function is activated by selecting <i>Enabled</i>.</p> <p>The function is enabled by default.</p>
<b>Show Connected Number (COLP)</b>	<p>Select whether the called party number shall be displayed to the caller.</p> <p>If, for example, the called party has set up call forwarding to a third subscriber, the caller can display the number of the call forwarding destination using this performance feature.</p> <p>The function is activated by selecting <i>Enabled</i>.</p> <p>The function is enabled by default.</p>
<b>Additional Info for Extern Call</b>	<p>Select what should be displayed for an exchange call.</p> <p>Possible values:</p> <ul style="list-style-type: none"> <li>• <i>Trunk and Number Name</i>: The display shows the exchange connection and the assigned name alternatively.</li> <li>• <i>Trunk Name Only</i>: Only the name assigned to the exchange connection is displayed.</li> <li>• <i>Number Name Only</i> (default value): The display shows the name assigned to the external number only.</li> <li>• <i>None</i>: Display is blank.</li> </ul>

### 10.2.2.2 Features

Additional functions are configured in the **Numbering->User Settings->Class of Services->Features** menu.

#### Call pickup

A call is signalled to a co-worker who is presently absent from his work station. You now have two options to respond to the caller. You could walk over to your colleague's telephone, or transfer your colleague's call to your phone. Assignment is done by the option **Pick-up Group** in the menu **Features**; the group is then assigned to a user. If the values are identical, a call pickup is possible. Call pickup is not possible for open inquiry.

System telephones can pick up calls via programmed function keys. You can set up line keys, connection keys and team keys on system telephones.

- Line key: An ISDN connection or a VoIP provider is set up under a connection key. The LED assigned to the line key indicates the connection status. The LED lights up if both B channels of a connection are in use, or when the maximum number of simultaneous connections over a VoIP provider is reached. If an external call is signalled on another internal telephone, you can pick it up by pressing this line key.
- Line key: A system user is set up under a connection key. The LED assigned to the connection key indicates the subscriber status (call, connection,...). If a call is signalled for this internal subscriber, you can pick it up by pressing this connection key.
- Team key: A team key is a normal line key to which the internal number of a team is assigned. The LED assigned to the team key indicates the team status (call, connection,...). If a call is signalled for this team, you can pick it up by pressing the team key.

#### Call waiting

As far as possible, you want to accept calls from every customer, even while you're already on the phone. If another call is signalled to your phone by a call-waiting tone or display notification, you can decide with which of two customers you wish to speak.

If a currently engaged subscriber is called, she gets automatic call-waiting. Call-waiting is possible for internal and external calls. The call-waiting connection is signalled to the called party visually and/or acoustically, depending on the terminal.

The called party can:

- Decline the call-waiting connection and proceed with the current call. The caller is then signalled "engaged".
- Accept the call-waiting connection and hold the current connection.

- Accept the call-waiting connection after the current connection is ended.
- Ignore the call-waiting connection. Call-waiting automatically ends after 30 seconds and the caller hears a "busy" signal.

### Analogue terminals

The call-waiting option can be individually configured for every subscriber. Allowing call waiting or not can be set via configuration or via a code number in operations.

Analogue terminals get the system call waiting tone. The number of the call-waiting party can be shown in the analogue telephone display if it features the corresponding performance feature (CLIP off Hook). CLIP off Hook is disabled for analogue terminals in the basic setting, but may be enabled via configuration.

Call waiting can only occur simultaneously in the system for a limited number of analogue connections. If call waiting is already operating with this maximum number of call-waiting tones on analogue connections, additional call-waiting callers will get the busy tone.

If you hear the call-waiting tone during a call, you can take that call and transfer the ongoing call. An operating procedure allows transfer of the ongoing call and acceptance of the call waiting. The following conditions apply here:

- Every dialled number is accepted by the system.
- After the operation procedure, the subscriber and the call-waiting subscriber are immediately connected to each other (no acknowledge tones).
- Transfer to one's own number is possible, then call waiting.
- Internal, external target subscribers as well as teams can be dialled.
- A return call occurs in case of invalid or engaged target number.
- If the subscriber is free, a return call is made according to the target subscriber's defined period.
- With transfer to a team number, there is no return call in case of an engaged or unreachable team
- With transfer to a team number only return call after time is supported.

### ISDN terminals

Configuration and operation of call waiting occurs as described in the users' guides of the corresponding terminals. ISDN terminals use their own tones to signal call waiting.



#### Note

Call waiting is not possible:

- for conference calls
- for do not disturb (analogue terminals)
- for announcements
- for room monitoring
- for terminals, for which the Data Protection performance feature is set up (e. g. fax, modem)
- in analogue subscriber's dialling status (the receiver has been picked up, but there is no connection yet)
- for current call-waiting protection
- for dialling a team number. Then there is no call waiting for analogue team subscribers.

ISDN telephones can also transfer a call waiting to another subscriber via the "Call Deflection" performance feature. An active connection is ended by replacing the receiver, for example. The call waiting connection is then signalled and can be accepted, e. g. by picking up the receiver.

The **Numbering->User Settings->Class of Services->Features** menu consists of the following fields:

#### Fields in the Feature Authorization menu.

Field	Description
<b>Pick-up Group</b>	Enter the number of the group in which calls may be picked up.
<b>Call Waiting</b>	Select whether call waiting shall be allowed for this authorisation class.  The function is activated by selecting <i>Allowed</i> .  The function is enabled by default.
<b>Use global rerouting</b>	Select whether global redirect shall be allowed for this authorisation class.  The function is activated by selecting <i>Enabled</i> .  The function is disabled by default.

Field	Description
	 <b>Note</b> The redirect target must be in a class of service that does not allow global redirect.
<b>Switch signalling variants manually</b>	Select whether manual switching of call options shall be allowed for this authorisation class.  The function is activated by selecting <i>Allowed</i> .  The function is disabled by default.
<b>Call Through</b>	Select whether Call Through shall be allowed for this authorisation class.  The function is activated by selecting <i>Allowed</i> .  The function is enabled by default.

### Simplex operation

The simplex operation function allows you to set up a connection from a system telephone to another system telephone without this connection having to be actively accepted by the called system telephone (pick up receiver, switch on loudspeaker/hands-free). As soon as the system telephone has accepted the simplex operation connection, the connection is set up. The caller and the called system telephone hear an attention tone at the beginning of the simplex operation. Duration of the simplex operation is limited to two minutes. If the receiver of a concerned telephone is picked up during this period, the call is translated into a normal connection.

System telephones can initiate a simplex operation call via the system telephone menu or a programmed function key. If the simplex operation is initiated via a function key, notifications appear in the system telephone display as with a normal connection and the simplex operation key LED is switched on. The simplex operation can be ended by renewed pressing of the function key or by pressing the loudspeaker key. The LED switches off again at conclusion of the simplex operation.

If a telephone or a system telephone is the destination of a simplex operation call, the caller's number is indicated in the display. The simplex operation call is signalled over the loudspeaker with an attention tone. Simplex operation can be terminated with the ESC key.

A function key can also be configured on a system telephone to deny or allow simplex operation calls.

**Note**

Simplex operation calls are automatically accepted by the called telephone by enabling the hands-free function, if:

- the telephone is not in use
- simplex operation is allowed and
- the "Do not disturb" function (Call Protection) is disabled.

If a simplex operation connection is not ended by both subscribers, the connection is automatically ended by the system after ca. 2 minutes.

**Message**

Do you wish to call your co-workers to a meeting or to a meal? You could call each of them individually, or simply use the announcement function. With just one call, you reach all the announcement-enabled telephones without subscribers having to pick up the receiver.

**Caution**

Although you can be heard with the announcement, you cannot hear any comments your colleagues or family members make.

The announcement function allows you to set up a connection to another telephone without this connection having to be actively accepted by the latter (pick up receiver or switch on loudspeaker/hands-free). As soon as a telephone has accepted the announcement, the connection is active. The announcer and the called subscriber initially hear a positive acknowledgement tone. Announcement duration is unlimited.

Announcements are possible to ISDN and analogue telephones if these support the announcement performance feature. Please refer to the user's guide for your telephones to determine whether the performance feature is supported.

Announcements can be allowed or denied to telephones via a code number.

**System telephones**

Announcement to and from system telephones is possible. System telephones can initiate an announcement via the system telephone menu or using a programmed function key. If the announcement is initiated via a function key, notifications appear in your telephone display as with a normal connection and the announcement key LED is switched on. The announcement can be ended by renewed pressing of the function key or by pressing the

loudspeaker key. The LED switches off again at conclusion of the announcement.

If a system telephone is the destination for an announcement, the number of the announcer appears on the display. The announcement is signalled with a positive acknowledge tone over the loudspeaker. The announcement can be terminated with the ESC key.

A function key with associated LED can also be set up on a system telephone to deny or allow announcements.

### Individual announcement

You can initiate the announcement in a selective manner by dialling an internal number. The announcement can be allowed or denied by the destination subscriber via an operating procedure. The announcement is signalled to the destination subscriber and the announcer with a positive acknowledge tone.

### Team announcement

An announcement can also be made to a team by dialling a team number. The team subscribers hear the announcement simultaneously. The announcement is signalled to the destination subscribers and the announcers with a positive acknowledge tone. The announcement to a team is also possible from an inquiry. With a team announcement, it can take up to four seconds before the connection to the individual team subscribers is established. The announcement then proceeds to the team subscribers who have accepted the announcement within this period.



#### Note

Announcements are automatically accepted by the called telephone by enabling the loudspeaker function, if:

- the telephone is not in use
- the announcement is set up and
- the "Do not disturb" function is not active.

### MWI (Message Waiting Indication)

You've got new messages in your mailbox, or new e-mails waiting at your Internet service provider. As you have no prior knowledge, you must constantly check whether you do actually have new messages. With the MWI performance feature, your system receives the information about new messages from the corresponding service provider. Now you merely need query your mailbox or e-mail POB if new messages really are present. You can also send a MWI from a voicebox connected to the system, or from a system telephone set up



as a reception telephone.

This information can be displayed or signalled on terminals (analogue terminals, ISDN terminals and system telephones) that support this performance feature. MMW information from outside is conveyed transparently by the system. When an MMI is present, the bintec elmeg telephone displays an envelope symbol and a text generated in the telephone, along with the caller's phone number.

### Analogue terminals

- Switching on the MMI can only occur with receiver replaced.
- If there's a message from a voicemail system, there's a short call. Depending on the terminal, a symbol, a text generated in the telephone as well as the caller's telephone number can be displayed. If MWI information is deleted, there is no signalling.
- For the terminal, CLIP must be set up and enabled in the configuration.
- Callback to the voice mail system or reception telephone is possible; the MMI information is deleted in the process.

### ISDN terminals

- Switching on the MWI is possible at all times (also during the call).
- If there's a message from a voicemail system, there's a short call. Depending on the terminal, a symbol, a text generated in the telephone as well as the caller's telephone number can be displayed. If MWI information is deleted, there is no signalling.
- Callback to the voice mail system or reception telephone is possible; the MMI information is deleted in the process.

### System telephones

- Switching on the MWI is possible at all times (also during the call). The caller's number is entered in the caller list. Depending on the type of system telephone, e. g. external voicemail, Netbox Heute, the name and number of the caller are entered. In addition, the **Caller list** LED flashes.
- Callback to the voice mail system or reception telephone is possible; the MMI information is deleted in the process.

### Hotel room telephone

- If a message from a voicemail system is present, a special dialling tone is heard after the receiver is picked up.

### Reception telephone

- MWI information can be switched on and off from a reception telephone to a room tele-

phone via a telephone procedure. If MWI information is switched to a room telephone, the reception telephone number is entered into the caller list and the special dialling tone is enabled.

### Disabling the MWI announcement

- Manual disabling via reception telephone procedure.
- Call from reception telephone to room telephone. The MWI information is automatically deleted in call status.
- Callback from room telephone to reception telephone deletes the MWI information.



#### Note

This performance feature must be requested for your ISDN connection from the network operator. There, you will also be informed of available services. The information can only be displayed on the internal ISDN terminal if an external MSN has been assigned to the terminal in the configuration.

All MWI data are deleted after a system reset.

### Net Direct (keypad)

Some time ago, you purchased the most advanced telephone of the time. Since then, however, a number of new performance features have appeared on the public network, which cannot be used by simply pressing a key. You can use the keypad function to employ your network operator's current ISDN functions by entering a key sequence from your ISDN or analogue telephone.

The keypad function allows control of service or performance features in your operator's network by entering character and numerical sequences.



#### Note

You can only use the keypad performance feature if it is supported by your network operator and has been requested for your ISDN connection. If you have set up an automatic outside line for an internal subscriber, the keypad functions cannot be directly used. First disable the **Automatic Outside Line** or dial the star key, then the code for manual outside line (e. g. 0) followed by keypad dialling, beginning with the star or hash key.

Keypad functions can only operate from terminals that have been assigned an external multiple subscriber number (MSN) in configuration and possess a keypad authorisation.

Your network operator's performance features are always set up for the number (MSN) sent by your terminal.

The menu **Advanced Settings** consists of the following fields:

#### Fields in the **Advanced Settings** menu.

Field	Description
<b>Receive System Intercom Call</b>	<p>Select whether simplex operation calls to the system telephone shall be allowed for this authorisation class.</p> <p>The function is activated by selecting <i>Allowed</i>.</p> <p>The function is enabled by default.</p>
<b>Receive Announcement Calls</b>	<p>Select whether this authorisation class may receive announcements.</p> <p>The function is activated by selecting <i>Allowed</i>.</p> <p>The function is enabled by default.</p>
<b>Receive MWI Information</b>	<p>Select whether this authorisation class may receive information about existing messages (MWI = Message Waiting Indication).</p> <p>The function is activated by selecting <i>Allowed</i>.</p> <p>The function is enabled by default.</p>
<b>Net Direct (Keypad)</b>	<p>Select whether you wish to use your network operator's current ISDN functions also from older ISDN or analogue telephones by entering a key sequence.</p> <p>The function is activated by selecting <i>Allowed</i>.</p> <p>The function is disabled by default.</p>

#### 10.2.2.3 Applications

Additional applications are configured in the **Numbering->User Settings->Class of Services->Applications** menu.

The **Numbering->User Settings->Class of Services->Applications** menu consists of the following fields:

**Fields in the Application Authorization menu.**

Field	Description
<b>System Phonebook Authorization</b>	<p>Select whether this authorisation class may use entries in the system phone book and, if so, to what extent.</p> <p>Possible values:</p> <ul style="list-style-type: none"> <li>• <i>Yes, according to line access authorization</i> (default value): System phone book entries may be used unless located beyond the configured line access authorisation.</li> <li>• <i>Yes, without restrictions</i>: System phone book entries may be used in unrestricted access.</li> <li>• <i>No</i>: System phone book entries may not be used.</li> </ul>
<b>Music on Hold</b>	<p>Select whether and which MoH (Music on Hold) shall be used.</p> <p>Possible values:</p> <ul style="list-style-type: none"> <li>• <i>Off</i> (default value): A caller on hold shall hear no music-on-hold.</li> <li>• <i>&lt;MoH-Wave file&gt;</i>: A caller on hold should hear the selected Wave file as music-on-hold.</li> <li>• <i>MOH Intern 1</i> (default value for compact systems)</li> <li>• <i>MOH Intern 2</i></li> <li>• <i>MoH Wave 1 to 8</i></li> </ul>
<b>Doorcom Access</b>	<p>Select whether this authorisation class may connect to the door intercom.</p> <p>The function is activated by selecting <i>Allowed</i>.</p> <p>The function is enabled by default.</p>
<b>TAPI</b>	<p>Select whether this authorisation class may use the system's TAPI functionalities.</p> <p>The function is activated by selecting <i>Allowed</i>.</p> <p>The function is enabled by default.</p>
<b>Save call data records</b>	<p>Define whether the connection data of this authorisation class shall be saved.</p>

Field	Description
	<p>The function is activated by selecting <i>Enabled</i>.</p> <p>The function is enabled by default.</p>
<b>Transmit charge information</b>	<p>Select whether the transferred charge information shall be transmitted to terminals of this authorisation class.</p> <p>The function is activated by selecting <i>Allowed</i>.</p> <p>The function is enabled by default.</p>
<b>Relay Contact(s) Access</b>	<p>Within an authorisation category, you can enable or prohibit the permission to configure a relay for each contact individually.</p> <p>The function is activated by selecting <i>Allowed</i>.</p> <p>The function is disabled by default.</p>

### 10.2.3 Parallel Ringing

In the **Numbering->User Settings->Parallel Ringing** you configure whether, in case of incoming calls to an internal number, there shall be parallel signalling to another external number.

#### 10.2.3.1 Edit or New

Choose the  icon to edit existing entries. Choose the **New** button to create other entries.

The **Numbering->User Settings->Parallel Ringing->New** menu consists of the following fields:

#### Fields in the **Basic Settings** menu.

Field	Description
<b>Internal Number</b>	Select the internal number for which the parallel call performance feature is to be set up.
<b>External Number</b>	Under <b>New Number</b> enter the external telephone number to which a call should be signalled in parallel. If a mobile number and a call number are configured for personal use under <b>Users-&gt;Basic Settings-&gt;External Numbers</b> , these are displayed in <b>Configured Home Number</b> or <b>Configured Mobile Number</b>

Field	Description
	and can be selected.
<b>Parallel Ringing</b>	<p>Select whether this parallel call entry is to be enabled.</p> <p>The function is activated by selecting <i>Enabled</i>.</p> <p>The function is disabled by default.</p>

## 10.3 Groups & Teams

In this menu, you configure your system's teams.

### 10.3.1 Teams

In the **Numbering->Groups & Teams->Teams** menu, you configure you system's teams.

Teams are groups of people working together to realise an objective. In practice, this means that all people within a team can be reached under the same subscriber number for external and internal calls. In the PABX, each team of telephones/terminals can thus be assigned a specific subscriber number to guarantee accessibility to internal and external calls. Individual structures of companies can be mapped by teams. Thus departments such as Service, Sales or Development can be called from inside or outside in a selective manner via team numbers. Within a team, the call can, for example, be signalled simultaneously to all, or first to one telephone, then also to a second, etc. In one team, answering machines or voice systems can also be used.

Four team call options are assigned to each team. Switching between call options can occur manually or via one of the calendars.

Only for compact systems: The *Team global* is configured by default.

Choose the  icon to edit existing entries. Select the **New** button to create a new team.

#### 10.3.1.1 General

In the **Numbering->Groups & Teams->Teams->General** basic conditions in the team are configured. Among these are the team name and the internal team number.

For internal team calls, a team number and team name can be assigned to the team in the configuration. If a team number is dialled, the caller sees the team name until a team subscriber accepts the call. The name of the team subscriber is then displayed.

The **Numbering->Groups & Teams->Teams->General** menu consists of the following fields:

#### Fields in the **Basic Settings** menu.

Field	Description
<b>Description</b>	Enter a description for the team.
<b>Internal Number</b>	Enter the internal number of the team.

#### Fields in the **Further Settings** menu.

Field	Description
<b>Switch call signalling</b>	<p>Define whether the call option configured for the team shall be enabled manually over the telephone, or via the calendar. For this, calendar and switching times must first have been configured. You can create up to four call variants for each team in the menu <b>Numbering-&gt;Groups &amp; Teams-&gt;Teams-&gt;New-&gt;Variant1-4</b> .</p> <p>Possible values:</p> <ul style="list-style-type: none"> <li>• <i>No calendar, only manually</i> (default value): Manual switch is enabled.</li> <li>• <i>&lt;Calendar&gt;</i>: Select one of the configured calendars.</li> </ul>
<b>Active Variant (Day)</b>	<p>Select one of the call options to be currently enabled. If a switch is set up via the calendar, this setting will be switched back again in a timely manner.</p> <p>The default value is <i>Signalling Variant 1</i>.</p>
<b>Permit Call Forwarding</b>	<p>Define whether call forwarding may occur for the team.</p> <p>The function is activated by selecting <i>Enabled</i>.</p> <p>The function is disabled by default.</p>
<b>Call Forwarding to External Numbers</b>	<p>Define whether there shall be call forwarding within the system itself (<b>Through PABX</b>, default value) or via an exchange (provider, <b>Through Exchange Office</b>). Please note that for call forwarding within the system two external connections are used.</p>

The menu **Advanced Settings** consists of the following fields:

**Fields in the Timer menu.**

Field	Description
<b>Team Speed Timer</b>	Here, enter the <b>Team Speed Timer</b> following which call forwarding after time shall be performed in the team. The default value is <i>15</i> seconds.
<b>Simultaneous after time</b>	With linear and rotating team calls, there is the option for all team subscribers to be simultaneously called after a defined period.  The default value is <i>60</i> seconds.
<b>Wrap-up Timer</b>	This setting is only enabled in <b>Signalling</b> <i>Even Distribution (Longest Free)</i> .  For every subscriber who has ended a call, a <b>Post processing time</b> is configured, during which he receives no more calls. Calls received by the subscriber on his number rather than via the team and self-initiated calls are not included in the time calculation.  The default value is <i>0</i> seconds; the range <i>0... 999</i> seconds.

**10.3.1.2 Variant 1 - 4**

In the **Numbering->Groups & Teams->Teams->Variant 1 - 4** you configure a team's four call variants. You can create up to four different call options for each team. For this, assign either an internal or external number to the call option, and define how an incoming call should be signalled within the team.

**Internal numbers of a team**

Under **Internal Assignment**, select the internal subscribers who are to belong to this team. If you wish to temporarily exclude a team subscribers from call signalling (e. g. team subscriber is on holiday), you can **Logout** the subscriber. Team calls are not signalled to logged out subscribers. Every team subscriber can also control login and logout himself via a system code.

For internal team calls, a team number and team name can be assigned to the team in the configuration. If a team number is dialled, the caller sees the team name until a team subscriber accepts the call. The name of the team subscriber is then displayed. A call to a team can be simultaneous, linear, rotating, setting up or parallel after time. With linear and rotating team calls, there is the option for all team subscribers to be simultaneously called after a defined period (1 - 99).



The **Numbering->Groups & Teams->Teams->Variant** menu consists of the following fields:

#### Fields in the **Basic Settings** menu.

Field	Description
<b>Assignment</b>	<p>You can assign several internal numbers to each team, or an external number to each. Define whether calls for a team shall be signalled to internal or external subscribers.</p> <p>Possible values:</p> <ul style="list-style-type: none"> <li>• <i>External</i>: The entered external number is called.</li> <li>• <i>Internal</i> (default value): The subscribers assigned to the selected number are called according to the defined signalling.</li> </ul>
<b>Internal Assignment</b>	<p>Only if <b>Assignment</b> = <i>Internal</i></p> <p>Select the internal team subscribers.</p> <p>With <b>Add</b>, you add more internal numbers.</p> <p>Only for compact systems: The numbers <i>10, 20, 21, 22</i> are assigned to the <i>Team global</i>.</p>
<b>External Assignment</b>	<p>Only if <b>Assignment</b> = <i>External</i></p> <p>Enter the number of the external subscriber.</p>
<b>Route and Charge Assignment</b>	<p>Only if <b>Assignment</b> = <i>External</i></p> <p>Charges for the call and assignment of an external connection occur via the selected internal subscriber.</p>

#### Automatic call acceptance in the team

You want a caller to be accepted already at call signalling and not to hear the ringing tone. That's no problem if you're using automatic call acceptance for team calls. In this case, the caller is automatically accepted by the system and hears an announcement or system music-on-hold. During this time, the call is signalled to the entered team subscribers. If a subscriber takes the call, the connection to the caller is established.

If a team is called, it can be defined in configuration that the call is automatically accepted, and that the caller hears an announcement or music. The target subscriber(s) are called

during this time. After the receiver is picked up, the announcement or music is turned off and the subscribers are connected to each other.

Possible settings for automatic call acceptance:

- *Simultaneous*: All assigned terminals are called simultaneously. If a terminal is busy, call waiting can be used.
- *Linear*: All assigned terminals are called in the sequence of their entry in configuration. If a terminal is engaged, the next free terminal is called. The call is signalled ca. 15 seconds per subscriber. This period can be set between 1 and 99 seconds (per team) in the configuration. If subscribers are on the phone or logged out, there is not forwarding time for these.
- *Rotating*: This call is a special case of the linear call. After all terminals are called, call signalling begins again with the first entered terminal. The call is signaled until the caller replaces the receiver or the call is ended by the exchange (after ca. 2 minutes).
- *Adding*: The terminals are called in the order of their entry in the subscriber list. Every terminal that has already been called is called again, until all entered terminals are called.
- *Linear, Simultaneous after time or Rotating, Simultaneous after time*: Rotating or linear is set for the team call. After defined times have run out, all team subscribers can be called in parallel (simultaneously). Example: A precondition is that the sum of forwarding times is larger than the time **parallel after time**. There are 4 subscribers to a team. The forwarding time for each subscriber is 10 seconds, 40 seconds in total. The time **parallel after time** is set to 38 seconds. Every subscriber will be called. If a subscriber logs out of the team or is engaged, forwarding time is only 30 seconds, after which the **parallel after time** call is no longer made.
- *Even Distribution (Longest Free)*: Even distribution corresponds to **SignallingRotating** and insures that all team subscribers receive the same number of calls. For every subscriber who has ended a call, a **Wrap-up Time** (0...999 seconds) is set up for the team/subscriber, during which she receives no more calls. Calls received by the subscriber on his number rather than via the team and self-initiated calls are not included in the even distribution calculation. Even distribution begins with the subscriber who hasn't received calls for the longest time, on restart with the first subscriber entered in the subscriber list. A subscriber who has logged out of the team (code number or function key) is no longer taken into account for the even distribution. After a system power failure, the existing **Even distribution** calculation is deleted and the process begins again. If all team subscribers are in **Post processing time**, external calls are routed to the preset redirect destination; internal calls hear the busy tone. If the same time since the last call is calculated for several team subscribers, the sequence of entries in **Internal Assignement** applies.

**Fields in the Options menu.**

Field	Description
<b>Signalling</b>	<p>You can call team subscribers with a broadcast call.</p> <p>Possible values:</p> <ul style="list-style-type: none"> <li>• <i>Simultaneous</i> (default value)</li> <li>• <i>Linear</i></li> <li>• <i>Rotating</i></li> <li>• <i>Adding</i></li> <li>• <i>Linear, Simultaneous after time</i></li> <li>• <i>Rotating, Simultaneous after time</i></li> <li>• <i>Even Distribution (Longest Free)</i></li> </ul>
<b>Busy on busy</b>	<p>Select whether the performance feature "Busy on Busy" is to be enabled for this call option.</p> <p>If a team subscriber is currently engaged, you can decide whether additional calls for this team should be signalled. If "Busy on Busy" is set for a team, other callers are signalled as "engaged".</p> <p>The function is activated by selecting <i>Enabled</i>.</p> <p>The function is disabled by default.</p>
<b>Automatic Call Pick-up with</b>	<p>Select whether an incoming call should be automatically accepted, and the caller hear the desired music-on-hold or announcement. Signalling of the call to the team proceeds. The caller bears the costs for the existing connection.</p> <p>The function is activated by selecting <i>Enabled</i>.</p> <p>The function is disabled by default.</p> <p>Also select the desired music-on-hold or announcement.</p> <p>Possible values:</p> <ul style="list-style-type: none"> <li>• <i>&lt;File_x&gt;</i></li> <li>• <i>MOH Intern 1</i></li> <li>• <i>MOH Intern 2</i></li> <li>• <i>MoH Wave 1 to 8</i></li> </ul>

The menu **Advanced Settings** consists of the following fields:

**Fields in the Rerouting Functions menu.**

Field	Description
<b>Rerouting on no response</b>	<p>Select whether and, if so, to which team an incoming call should be redirected on no reply.</p> <p>Possible values:</p> <ul style="list-style-type: none"> <li>• <i>None</i> (default value)</li> <li>• <i>&lt;Team&gt;</i></li> </ul> <p>Also enter the time after which the call should be redirected.</p>
<b>Further Rerouting</b>	<p>Select whether and, if so, to which redirect option an incoming call shall be switched.</p> <p>Possible values:</p> <ul style="list-style-type: none"> <li>• <i>Off</i> (default value): No other redirect options are used.</li> <li>• <i>Immediately</i>: The incoming call is immediately rerouted to the redirect function selected in <b>Immediately</b>.</li> <li>• <i>On Busy</i>: The incoming call is rerouted to the redirect function selected in <b>On Busy</b>.</li> </ul>
<b>Immediately</b>	<p>Only if <b>Further Rerouting</b> = <i>Immediately</i></p> <p>Select the redirect function for immediate redirect. Configure redirect functions in <b>Applications-&gt;Rerouting-&gt;Rerouting Functions</b>.</p>
<b>On Busy</b>	<p>Only if <b>Further Rerouting</b> = <i>On Busy</i></p> <p>Select the redirect function for redirect on engaged. Configure redirect functions in <b>Applications-&gt;Rerouting-&gt;Rerouting Functions</b>.</p>
<b>Busy starting with</b>	<p>Only if <b>Further Rerouting</b> = <i>On Busy</i></p> <p>Select from which number of subscribers the team is considered engaged.</p>

### 10.3.1.3 Log on / Log off

In the **Numbering->Groups & Teams->Teams->Log on / Log off** individual team members are logged in or out.

The **Numbering->Groups & Teams->Teams->Log on / Log off** menu consists of the following fields:

#### Fields in the **Basic Settings** menu.

Field	Description
<b>Numbers</b>	Indicates the internal number of assigned team members.
<b>Status</b>	Select whether the team member is logged into the team.  The team member is logged in by selecting <i>Logged on</i> .  Only for compact systems: All team members are <i>Logged on</i> by default..

## 10.4 Call Distribution

In this menu, you configure internal forwarding of all incoming calls.

### 10.4.1 Incoming Distribution

In the **Numbering->Call Distribution->Incoming Distribution** menu, you configure the assignment of incoming calls to the desired internal numbers..

In Call Assignment, you assign the call numbers entered under **External Numbers**, e.g. to the teams or to an internal number.

#### 10.4.1.1 Edit

Choose the  icon to edit existing entries.

The **Numbering->Call Distribution->Incoming Distribution->**  menu consists of the following fields:

#### Fields in the **Basic Settings** menu.

Field	Description
<Name of Number-Entry>	Displays the number configured.
Trunk	Displays the external connection for which call assignment is configured.
Assignment	<p>Select the internal number or the desired function to which incoming calls shall be assigned via the line selected in <b>Trunk</b>.</p> <p>Possible values:</p> <ul style="list-style-type: none"> <li>• <i>Internal Number</i> (default value): The internal team number is selected for assignment to a team.</li> <li>• <i>Call Through</i></li> <li>• <i>Redirect application</i></li> <li>• <i>Phone Remote Access</i></li> <li>• <i>ISDN Login</i></li> <li>• <i>Service Login</i></li> <li>• <i>Mini Call Center</i></li> </ul>

#### Fields in the Internal Number and Rerouting Settings menu.

Field	Description
Internal Number	<p>Only for <b>Assignment</b> = <i>Internal Number</i></p> <p>Select the internal number to which incoming calls shall be assigned via the line selected in <b>Trunk</b>.</p>
Rerouting Application	<p>Only for <b>Assignment</b> = <i>Rerouting Application</i></p> <p>Select the desired redirect application to be assigned to the number. You can configure redirect applications in the <b>Applications-&gt;Rerouting-&gt;Rerouting Applications</b> menu.</p>
Active Variant (Day)	<p>Only for redirect application = <i>&lt;configured redirect application&gt;</i></p> <p>Select the redirect application variant to be currently enabled. If a variant switch is set up via the calendar, this setting will be switched back again at the appropriate time.</p> <p>Possible values:</p>

Field	Description
	<ul style="list-style-type: none"> <li>• <i>Variant 1</i></li> <li>• <i>Variant 2</i></li> <li>• <i>Variant 3</i></li> <li>• <i>Variant 4</i></li> </ul>

#### Fields in the **Call Through Settings** menu.

Field	Description
<b>Authorization</b>	<p>Only for <b>Assignment</b> = <i>Call Through</i></p> <p>Define the authorisation for which the Call Through function shall be released.</p> <p>Possible values:</p> <ul style="list-style-type: none"> <li>• <i>Number screening</i>: Dialling release occurs after matching the entered number with the entry in the system phone book or with the user's call number entries (<b>Mobile Number</b> and <b>Home Number</b>).</li> <li>• <i>Number screening and PIN</i>: Dialling release occurs after matching the entered number with the entry in the system phone book or with the user's call number entries (<b>Mobile Number</b> and <b>Home Number</b>) AND PIN entry.</li> <li>• <i>PIN</i>: Dialling release occurs after PIN entry.</li> <li>• <i>Number screening or PIN</i>: Dialling release occurs after matching the entered number with the entry in the system phone book or with the user's call number entries (<b>Mobile Number</b> and <b>Home Number</b>) OR PIN entry.</li> </ul>
<b>PIN (6 Digit Numeric)</b>	<p>Only for <b>Authorization</b> = <i>Number screening and PIN, PIN, Number screening or PIN</i></p> <p>The system checks the caller's authorisation for Call Through, then activates a simulated external dialling tone for the call. Authorisation is granted if the caller has entered the correct 6-digit PIN.</p>
<b>Internal Number and Rerouting Settings</b>	<p>Select the internal subscriber via which Call Through is to occur. One of the system's telephone numbers is defined in the configuration for Call Through. An external caller using this telephone number first hears the system's attention tone.</p>

## 10.4.2 Misdial Routing

In the menu **Numbering->Call Distribution->Misdial Routing** for every external connection, you define the subscriber or the team to which the call shall go in any of the following cases:

- an incoming call has a wrong or truncated number / extension
- all members of the called team or call center are logged off.
- all members of the called call center are in post-processing.

Only for compact systems: A predefined entry with the parameters **Trunk** = *ISDN Extern* and **Rerouting to Number** = *40 (Team global)* is displayed.

### 10.4.2.1 Edit

Choose the  icon to edit existing entries.

The **Numbering->Call Distribution->Misdial Routing->**  menu consists of the following fields:

**Fields in the Basic Settings menu.**

Field	Description
<b>Trunk</b>	Displays the external connection for which redirect for wrong dialling is configured.
<b>Rerouting to Number</b>	Select the type of rerouting: <ul style="list-style-type: none"> <li>• <i>None</i>: No redirect here, the caller gets a busy tone.</li> <li>• <i>Global Settings</i>: Redirect occurs as entered in <b>System Management-&gt;Global Settings-&gt;System-&gt;Rerouting to Number</b>.</li> <li>• <i>&lt;Internal number of a user or team&gt;</i>: The call is redirected to this user or team.</li> </ul>



## Chapter 11 Terminals

### 11.1 elmeg System Phones

In this menu, you perform the assignment of configured internal numbers to the terminals and manage additional functions depending on the type of terminal.

The system telephone end devices (or DECT bases, respectively) are listed alphabetically in the **Description** column. Click the column title of any other column to sort entries in ascending or descending order.

Connected telephones or DECT bases are automatically recognized and listed in the respective summary; they can, however, also be manually configured before being connected to the system.

#### 11.1.1 System Phone

A list of system telephones is displayed in the **Terminals->elmeg System Phones->System Phone** menu; it shows manually configured telephones as well as automatically detected ones.

The basic configuration is the same for all telephones, but there are differences in the scope of service and configuration of several features (depending on the telephone type). If you cannot use a specific feature with the selected telephone, it is not offered for configuration.

Depending on its type, you can connect the system telephone to the internal ISDN, S0, UPO or Ethernet port. The system telephone offers typical system features in connection with the PABX system. For example:

- Dialling from the system phone book
- Announcement and simplex operation with other system telephones on the system
- Function keys for control of system features (enable call options, login/logout in teams, line keys, connection keys). The status of a feature can be indicated via LED's assigned to individual function keys.
- Access to the system menu of the system. In this menu, advanced functions are offered by the PABX system.

Choose the  icon to edit existing entries.

As soon as a **Description** is entered for the system telephone and an entry is selected in

the **Internal Numbers** field and copied with **OK**, the entry for that device is moved to the upper part of the overview. To continue configuration, click the  symbol again.

Choose the  icon to copy existing entries. Copying an entry can prove useful if you wish to create an entry only distinguished by a few parameters from an existing entry. In this case, you copy the entry and modify the desired parameters.

Select the **New** button to create a new system telephone entry.



#### Note

Configuration modifications are transmitted to the system telephones at the earliest 30 seconds after confirming the modification with the **Apply** button.

### 11.1.1.1 General

In the **Terminals->elmeg System Phones->System Phone->General** menu, you perform basic settings for a system telephone.

#### Telephone type

Various types of telephones can be configured.

If the system telephones are first configured in the system with type and serial number, the system detects the system telephone after hook up to the connection. Then the configuration created for this system telephone is transmitted by the system to the system telephone.

Alternatively, you can create a system telephone in your PABX system, select the appropriate telephone type, and assign an MSN. If you connect a telephone with default settings to your PABX system, the telephone answers with the question for the language and the first MSN. When you enter the language into the system telephone, and the MSN that you have configured in the PABX system, the PABX system sends the configuration to the telephone.

If the system telephone is removed, the system detects this and identifies the entry into the system with a red arrow. If another system telephone of the same type is subsequently connected, the system detects this and assigns the detected system telephone the corresponding configuration. The system telephone thus receives the same configuration as its predecessor, despite a different serial number. Only the first MSN must be identically entered in the system telephone and the system.

The **Terminals->elmeg System Phones->System Phone->General** menu consists of the following fields:

Fields in the menu **Basic Settings**

Field	Description
<b>Description</b>	To clearly identify the telephone in the system, enter a description for the telephone.
<b>Phone Type</b>	<p>Displays the type of the connected telephone. If the interface is configured, the system automatically reads out the type. The field can then no longer be edited if a telephone is connected.</p> <p>Possible values:</p> <ul style="list-style-type: none"> <li>• <i>ISDN / Upn</i></li> <li>• <i>IP</i></li> </ul> <p>For <b>Phone Type</b> = <i>ISDN / Upn</i> : Displays the system telephone product description, if it is supported by your device.</p> <p>Possible values:</p> <ul style="list-style-type: none"> <li>• <i>CS290</i></li> <li>• <i>CS290-U</i></li> <li>• <i>CS400xt</i></li> <li>• <i>CS410</i></li> <li>• <i>CS410-U</i></li> <li>• <i>S530</i></li> <li>• <i>S560</i></li> </ul> <p>For <b>Phone Type</b> = <i>IP</i> : Displays system telephone product description.</p> <p>Possible values:</p> <ul style="list-style-type: none"> <li>• <i>IP-S290</i></li> <li>• <i>IP-S290plus</i></li> <li>• <i>IP-S400</i></li> </ul>
<b>Location</b>	<p>Only for <b>Phone Type</b> = <i>IP</i></p> <p>Select the location of the telephone. You define location in the <b>VoIP-&gt;Settings-&gt;Locations</b> menu. Depending on the setting in this menu, default behaviour for registration of VoIP subscribers for which no location should be defined is displayed for selec-</p>

Field	Description
	<p>tion.</p> <p>Possible values:</p> <ul style="list-style-type: none"> <li>• <i>Not defined (Unrestricted Registration)</i>: No location is defined. According to set default behaviour, the subscriber is nevertheless registered.</li> <li>• <i>Not defined (No Registration)</i>: No location is defined. According to set default behaviour, the subscriber is not registered.</li> <li>• <i>Not defined (Registration for Private Networks Only)</i>: No location is defined. According to set default behaviour, the subscriber is only registered if located in a private network.</li> <li>• <i>&lt;Location&gt;</i>: A defined location is selected. The subscriber is only registered if at this location.</li> </ul>
<b>Interface</b>	<p>Only for <b>Phone Type</b> = <i>ISDN / Upn</i></p> <p>Displays the interface to which the terminal is connected. If the interface is configured, the system automatically reads out the type. The field can then no longer be edited if a telephone is connected.</p> <p>Possible values:</p> <ul style="list-style-type: none"> <li>• <i>None</i></li> <li>• <i>&lt;interface designation&gt;</i></li> </ul>
<b>Serial Number</b>	<p>Displays the serial number of the device. If the interface is configured, the system automatically reads out the serial number. This field cannot be subsequently edited.</p>

#### Fields in the menu **Number Settings**

Field	Description
<b>Internal Numbers</b>	<p>Select the internal number for this terminal You can assign internal numbers for 10 MSN's. By default, up to 3 MSN's can be assigned for system telephones Up to 3 MSN's are available for terminals in the 290 series. Up to five MSN's are available for terminals in the S5x0 series. Up to 10 MSN's are available for terminals in the CS400 and 4xx series</p>

Field	Description
	<p>Please note that for proper operation of the telephone, at least the first MSN must be entered in the system.</p> <p>Possible values:</p> <ul style="list-style-type: none"> <li>• <i>No free Extension Available</i>: All configured internal numbers are already in use. First configure another user with additional numbers.</li> <li>• <i>No number selected</i>: No internal number shall be assigned to this MSN.</li> <li>• <i>&lt;Internal Number&gt;</i>: Select one of the existing numbers of the configured users.</li> </ul>

### Key extensions

The T400 key extension (available for CS4xx series telephones and for IP-S400) features 20 keys with LED's usable as function keys on two levels. The LED's are assigned to the first key level. Two other LEDs are used to display additional information. You can connect up to 3 key extensions in sequence (cascading) to your telephone. A plug power supply unit must be used if using more than two key extensions.

The T400 /2 key extension (available for CS4xx series telephones and for IP-S400) features 10 keys with LED's usable as function keys on two levels. The LED's are assigned to the first key level. Two other LEDs are used to display additional information.

The T500 key extension (available for CS530 and S560 telephones) features 30 keys that can be used as function keys on two levels. To the right of each key, two LED's indicate which level is active. You can connect up to 3 key extensions in sequence (cascading) to your telephone. A plug power supply unit is required from the first key extensions.

### Fields in the menu Extensions

Field	Description
<b>Key Extension Module 1 - 3</b>	<p>Displays whether you're operating the system telephone with a key extension module.</p> <p>Possible values (each according to <b>Phone Type</b>):</p> <ul style="list-style-type: none"> <li>• <i>Not available</i></li> <li>• <i>T400</i></li> <li>• <i>T400/2</i></li> <li>• <i>T500</i></li> </ul>

The menu **Advanced Settings** consists of the following fields:

#### Fields in the menu **Codec Settings**

Field	Description
<b>Codec Profile</b>	Select the codec profile to be used if the connection is over a VoIP line. Codec profiles are configured in the <b>VoIP-&gt;Settings-&gt;Codec Profiles</b> menu.

#### Fields in the menu **Further Settings**

Field	Description
<b>Emergency Phone</b>	<p>The system telephones of your system can be set up as emergency telephones. You can immediately begin dialling externally, whether any external connections are active or not. If all external connections are already in use, one of the active calls is terminated and the connection is used for the emergency call. If an emergency call is already being made, it is not interrupted. You can use this performance feature regardless of the performance feature priority for emergency calls.</p> <p>The function is activated by selecting <i>Enabled</i>.</p> <p>The function is disabled by default.</p>

### 11.1.1.2 Settings

In the **Terminals->elmeg System Phones->System Phone->Settings** you can release specific performance features and functions for this system telephone.

The **Terminals->elmeg System Phones->System Phone->Settings** menu consists of the following fields:

#### Fields in the menu **Basic Settings**

Field	Description
<b>Display Language</b>	<p>Select the display language for your telephone.</p> <p>Possible values:</p> <ul style="list-style-type: none"> <li>• <i>Deutsch</i></li> <li>• <i>Dutch</i> : Not for <b>S530</b> and <b>S560</b></li> <li>• <i>English</i></li> <li>• <i>Italian</i></li> </ul>

Field	Description
	<ul style="list-style-type: none"> <li>• <i>Danish</i>: Not for <b>S530</b> and <b>S560</b></li> <li>• <i>Spanish</i>: Not for <b>S530</b> and <b>S560</b></li> <li>• <i>Swedish</i>: Not for <b>S530</b> and <b>S560</b></li> <li>• <i>French</i>: Not for <b>S530</b> and <b>S560</b></li> <li>• <i>Portugues</i>: Not for <b>S530</b> and <b>S560</b></li> <li>• <i>Česko</i>: Not for <b>S530</b> and <b>S560</b></li> <li>• <i>Norwegian</i>: Not for <b>S530</b> and <b>S560</b></li> <li>• <i>Greek</i>: Not for <b>S530</b> , <b>S560</b> , <b>CS290</b> , <b>CS290-U</b> , <b>IP-S290</b> , <b>IP-S290plus</b></li> <li>• <i>Icelandic</i>: Not for <b>S530</b> , <b>S560</b> , <b>CS400</b> , <b>CS410</b> , <b>CS410-U</b> , <b>IP-S400</b></li> <li>• <i>Polish</i>: Not for <b>S530</b> and <b>S560</b></li> <li>• <i>Hungarian</i>: Not for <b>S530</b> and <b>S560</b></li> <li>• <i>Russian</i>: Not for <b>S530</b> , <b>S560</b> , <b>CS290</b> , <b>CS290-U</b> , <b>IP-S290</b> , <b>IP-S290plus</b></li> </ul>
<b>Headset Support</b>	<p>Not for <b>S530</b> and <b>S560</b>.</p> <p>Select whether the headset should automatically accept calls.</p> <div data-bbox="541 994 1315 1216" style="border: 1px solid #ccc; background-color: #f0f0f0; padding: 10px; margin-top: 10px;">  <p><b>Note</b></p> <p>If you wish to use a headset, you must configure a headset key and a key for automatic call acceptance on your PABX system. On the system telephone, you must select a headset type and enable the key for automatic call acceptance.</p> </div>
<b>Call Waiting</b>	<p>Select whether another call shall be supported for this telephone through call waiting or a display notification.</p> <p>The function is activated by selecting <i>Enabled</i>.</p> <p>The function is disabled by default.</p> <p>If <b>Call Waiting</b> is enabled, define for which calls you wish to allow call waiting.</p> <p>Possible values:</p>

Field	Description
	<ul style="list-style-type: none"> <li>• <i>Internal Calls</i></li> <li>• <i>External Calls</i></li> <li>• <i>Internal and External Calls</i></li> </ul> <p>Under <b>Call Waiting Signal repeated</b> also decide whether the call waiting tone or the display notification should only be signalled once, or repeated for the call duration.</p>
<b>Do not Disturb (DND)</b>	<p>Only for telephones in the <b>CS4xx</b> series, the <b>S530</b> telephones and <b>S560</b> and the <b>IP-S400</b> telephone.</p> <p>For the <b>S530</b> and <b>S560</b> telephones, you merely configure the function here. With these telephones, enable <i>Do not Disturb</i> via the function key.</p> <p>Select whether you wish to use the call protection (do not disturb) performance feature.</p> <p>With this performance feature, you can enable call signalling to your terminal.</p> <p>Select for which number you wish to use the station guarding performance feature.</p> <p>Possible values:</p> <ul style="list-style-type: none"> <li>• <i>First Number only</i> (<b>CS4xx</b> series only): Call protection applies only to the first configured MSN.</li> <li>• <i>All Numbers</i> (<b>CS4xx</b> series only): Call protection applies to all configured MSN's.</li> </ul> <p>Select whether incoming calls shall be signalled:</p> <ul style="list-style-type: none"> <li>• <i>Off</i>: Calls are signalled.</li> <li>• <i>On</i> (<b>CS4xx</b> series only): Calls are not signalled.</li> <li>• <i>Acknowledgement Tone only</i> (<b>CS4xx</b> series only): An attention tone is heard once for a call</li> <li>• <i>Attention tone 1</i> (only <b>S530</b> and <b>S560</b>)</li> <li>• <i>Attention tone 2</i> (only <b>S530</b> and <b>S560</b>)</li> <li>• <i>Attention tone 3</i> (only <b>S530</b> and <b>S560</b>)</li> <li>• <i>Attention tone 4</i> (only <b>S530</b> and <b>S560</b>)</li> <li>• <i>No attention tone</i> (only <b>S530</b> and <b>S560</b>)</li> </ul>



The menu **Advanced Settings** consists of the following fields:

#### Fields in the menu **Advanced Settings**

Field	Description
<b>Status LED</b>	<p>Select whether and, if so, which events should be signalled by the system telephone status LED.</p> <p>Possible values:</p> <ul style="list-style-type: none"> <li>• <i>Off</i>: The status LED function is not used.</li> <li>• <i>Caller List</i>: The status LED signals calls and new messages.</li> <li>• <i>Messages only</i>: The status LED only signals new messages (MWI).</li> <li>• <i>New Message (nur S5x0)</i></li> <li>• <i>New Call (nur S5x0)</i></li> <li>• <i>Active Call (nur S5x0)</i></li> </ul> <p>You can use <i>New Message</i> <i>New Call</i> the options , <i>Active Call</i> and individually, or combine them freely.</p>
<b>Directory Softkey</b>	<p>Only for telephones in the <b>CS4xx</b> series</p> <p>Select whether calls shall be made with the softkey entries from the system phone book ( <i>System</i>) or from the telephone phone book ( <i>Telephone</i>).</p>
<b>Conversation Display</b>	<p>Not for <b>S5x0</b></p> <p>Select which information shall be indicated in the system telephone display during a call.</p> <p>Possible values:</p> <ul style="list-style-type: none"> <li>• <i>Number and Charge or Duration</i></li> <li>• <i>Number and Charge</i></li> <li>• <i>Number and Duration</i></li> <li>• <i>Number and Time</i></li> <li>• <i>Number only</i></li> <li>• <i>Date and Time only</i></li> </ul>
<b>Default Signalling dur-</b>	Select whether DTMF signals or keypad functions shall be

Field	Description
ing Calls	<p>transmitted into the system in call status. You can use special functions during a call by entering character and numerical sequences. These entries must be made as keypad or MFV sequences, depending on the function to be used. You can define whether MFV or keypad functions are possible in the basic setting during a call.</p> <p>Possible values:</p> <ul style="list-style-type: none"> <li>• <i>DTMF</i> (default value)</li> <li>• <i>Keypad</i></li> </ul>
Automatic Call Pick-up	<p>Select the period after which calls to this system telephone should be automatically accepted without you having to pick up the receiver or press the loudspeaker key.</p> <div data-bbox="541 727 1315 915" style="border: 1px solid gray; background-color: #f0f0f0; padding: 5px; margin: 10px 0;">  <p><b>Note</b></p> <p>Please note that to be able to use this function at least one telephone key must be assigned to automatic call acceptance.</p> </div> <p>Only for <b>S5x0</b></p> <p>You switch on automatic call acceptance with <i>Enabled</i>.</p> <p>You can configure the corresponding duration in the <b>Terminals-&gt;elmeg System Phones-&gt;System Phone-&gt;New-&gt;Keys</b> menu.</p> <p>Only for <b>x290xx</b> = and <b>x4x0xx</b>.</p> <p>Possible values:</p> <ul style="list-style-type: none"> <li>• <i>Immediately</i></li> <li>• <i>After 5 seconds</i></li> <li>• <i>After 10 seconds</i></li> </ul>
Mute after hands-free Calling	<p>Not for <b>S5x0, CS290, CS290-U</b></p> <p>You can dial the number of a subscriber without picking up the receiver (e. g. hands-free). Here, you have the choice of whether the built-in microphone shall be switched on immediately or only after pressing of the corresponding softkey. If the micro-</p>

Field	Description
	<p>phone is turned off during dialling, the corresponding softkey must be pressed, even if the connection is already active.</p> <p>The function is activated by selecting <i>Enabled</i>.</p> <p>The function is disabled by default.</p>
<b>Receiving UUS</b>	<p>Select whether performance feature UUS (User to User Signalling) can be used for this telephone. With this performance feature, you can receive short text messages from other telephones. In this way, you can send written information within the system, e. g. <i>Meeting at 9:30 AM or Am on holiday until Monday</i>.</p> <p>Possible values:</p> <ul style="list-style-type: none"> <li>• <i>Off, UUS are blocked</i>: The UUS performance feature is not used.</li> <li>• <i>Internal only</i>: Text messages can only be received internally.</li> <li>• <i>External only</i>: Text messages can only be received externally.</li> <li>• <i>Internal and External</i> (default value): Text messages can only be received internally and externally.</li> </ul>
<b>Receive System Intercom Call</b>	<p>Only visible when a <b>Number / User</b> is selected in the <b>Terminals-&gt;elmeg System Phones-&gt;System Phone-&gt;General</b> menu under <b>Internal Numbers</b>.</p> <p>Select whether the <b>Receive System Intercom Call</b> function should be allowed.</p> <p>The function is disabled by default.</p>
<b>Receive Announcement Calls</b>	<p>Only visible when a <b>Number / User</b> is selected in the <b>Terminals-&gt;elmeg System Phones-&gt;System Phone-&gt;General</b> menu under <b>Internal Numbers</b>.</p> <p>Select whether the <b>Receive Announcement Calls</b> function should be allowed.</p> <p>The function is disabled by default.</p>

### 11.1.1.3 Keys / T400 / T400/2 / T500

The menu **Terminals->elmeg System Phones->System Phone->Keys** displays the configuration of your system telephone's keys.

Your telephone features several function keys to which you can assign various functions on two levels. The functions that can be programmed on the keys vary from telephone to telephone.

Every function key with automatic LED functions (e. g. connection keys, line keys) can only be programmed once per system (telephone and key extensions).

#### Values in the list Keys

Field	Description
<b>Key</b>	Displays the name of the key.
<b>Label Description</b>	Displays the configured key name. This appears on the labelling page (label strips).
<b>Key Type</b>	Displays the key type.
<b>Settings</b>	Displays the additional settings with a summary

**Print** allows you to print out a label sheet for the description field of your system phone or key extension.

#### Edit

Choose the  icon to edit existing entries. In the pop-up menu, you configure the functions of your system telephone keys.

You can use the following functions with system telephones:

- *MSN Selection Key*: You can perform an internal or external call so that your system telephone transmits a specific number (MSN) to the caller. This number (MSN) has to be configured on your system telephone. If the LED is active, there is an active connection via this key.
- *Dial Key (Standard)*: You can store a number on each function key. External numbers have to be prefixed by the exchange code *0if no automatic outside line* has been configured for your **Class of Service** on the telephone.
- *Dial Key (DTMF)*: You can store a DTMF sequence on every function key.

- *Dial Key (Keypad sequence)*: You can store a keypad sequence on every function key.
- *Extension Key (User)*: You can set up dialling to an internal extension using a line key. After pressing the corresponding key, hands free is switched on and the internal extension entered is selected. If a call is signalled on the internal extension you have entered, you can pick this up by pressing the line key.
- *Extension Key (Team)*: You can set up dialling to a team using a line key. After pressing the corresponding key, hands-free is activated and the entered team is called according to its enabled call option. If a call is signalled for the entered team, you can pick it up by pressing this connection key.
- *Trunk Line*: An ISDN connection or a VoIP provider is set up under a connection key. If this key is pressed, automatic hands-free is enabled and the corresponding ISDN connection is assigned. You then hear the external dialling tone. If an external call is signalled on another internal telephone, you can pick it up by pressing this line key.
- *System Call (Announcement User)*: You can set up a connection to another telephone without this connection having to be actively accepted. As soon as the telephone has accepted the announcement, the connection is established and the announcement key LED is enabled. The announcement can be ended by renewed pressing of the announcement key or by pressing the loudspeaker key. The LED switches off again at conclusion of the announcement.
- *System Call (Announcement Team)*: You can configure an announcement for a team by setting up a function key. The way this works is the same as that described above.
- *Login / Log Out, Team*: If you are entered as a subscriber in the call assignments for one or more teams, you can set up a key so that you can control the call signalling of your telephone. If you're logged in, team calls are signalled to your telephone. If you are logged out, no team calls will be signalled.

The call numbers entered in the telephone can be logged in/logged out from a team using a set function key (**MSN-1... MSN-9**). Before entering a team number, you must select the telephone call number index (MSN) that is entered in the corresponding team call assignments.

- *System Call (Announcement enable)*: You can also selectively deny or allow announcements using a function key. To use announcements, you must be authorised for the corresponding authorisation class.
- *Receive Intercom Calls*: You can set up a key in such a way that a connection to the specified telephone is established without this connection having to be actively accepted.
- *System Call (Intercom enable)*: You can set up a key in such a way that the simplex operation function is allowed or denied. To use simplex operation, the function must be allowed in the corresponding authorisation class.

- *Boss Key/Secretary Key*: You can set up a key as a special line key. The Boss telephone and Secretary telephone properties are saved in both telephones with these keys.
- *Diversion Secretary*: You can set up a key in such a way that incoming calls to the Boss telephone are automatically routed to the Secretary telephone.
- *Call Forwarding (CFNR)*: You can set up a key so that delayed call diversion is configured for a specific number (MSN) on your system telephone. Pressing the key when the phone is not in use turns call forwarding on and off. Call forwarding configuration over a programmed key is only possible for numbers 1 to 9 (MSN-1...MSN-9) of the phone. In order to be able to use call forwarding, you need to have set up at least one number.
- *Call Forwarding (CFU)*: You can set up a key so that immediate call diversion is configured for a specific number (MSN) on your system telephone. Pressing the key when the phone is not in use turns call forwarding on and off. Call forwarding configuration over a programmed key is only possible for numbers 1 to 9 (MSN-1...MSN-9) of the phone. In order to be able to use call forwarding, you need to have set up at least one number.
- *Call Forwarding (CFB)*: You can set up a key so that call diversion on engaged is configured for a specific number (MSN) on your system telephone. Pressing the key when the phone is not in use turns call forwarding on and off. Call forwarding configuration over a programmed key is only possible for numbers 1 to 9 (MSN-1...MSN-9) of the phone. In order to be able to use call forwarding, you need to have set up at least one number.
- *Macro Function*: You can configure a key so that by pressing it a saved macro is executed.

The macro function can only be programmed at the phone.

- *Headset Control* (not with the **S5x0**): If you've connected and configured a headset to your telephone over a separate headset socket, operation of the headset occurs over a function key. Press the headset key to initiate or accept calls. If you already have an active connection over the headset, you can end the call by pressing the headset key.
- *Automatic Call Pick-up*: Your telephone can accept calls automatically without you having to lift the receiver or press the loudspeaker key. Automatic call acceptance is switched on or off using the function key assigned. You can configure a separate function key for each number ("MSN-1"... "MSN-9"), or a function key for all numbers. The period after which calls are automatically accepted is configured once for all numbers of the telephone.
- *Trunk Group Access*: Several external ISDN (if supported by you device) or IP connections to bundles can be grouped in the system. With a bundle key, you can save these connections on a function key. If this key is pressed, automatic hands-free is enabled and a free B channel of the corresponding bundle is assigned. You then hear the external dialling tone.

- *Connection Key* (not with the **S5x0**): In addition to the softkeys "Connection 1..", function keys can be configured on the system telephone or the extension for operation while brokering. At least two connection keys must be configured.
- *Hotel Rooms*: You can assign a key in such a way that when pressed, the guest is checked in or out (first level), or the selected hotel room phone is called (second level). You must configure this key on the first level, then the connected key on the second level is automatically assigned and, as the case applies, its content overwritten.
- *System Parking (Open Enquiry)*: The called party is put on hold for enquiry and dials a code. The telephone is now freed for other operations, e. g. announcements. Another party can accept the call, if he lifts the receiver and dials the relevant code of the held call. The codes assigned by the PABX can also be entered in the function keys of one or more system telephones. If a call is set to open hold for enquiry by pressing the function key, this is indicated by flashing LEDs on the function keys for the system telephones set up for this. The call is transferred by pressing the corresponding function key. This performance feature is only possible if only one call is on hold.
- *Agent wrap-up Time*: You can configure a key so that when it is pressed, an agent's post-processing time is switched on or off at a team call centre (first level), or extended (second level).
- *Night Mode*: You can configure a key so that by pressing it night operation is switched on or off.



#### Note

To manually switch night operation off again, the authorisation class **Switch signalling variants manually** must be enabled.

- *Parallel Ringing* (only **S5x0**): If a parallel call to another telephone is configured, both connections will ring when a call comes in. The call is accepted where first picked up.
- *Shift* (only **S5x0**): With this key, you can access second level functions.
- *Do not Disturb* (only **S5x0**): With this key, you enable or disable the Do not Disturb function which you have configured under **Terminals->elmeg System Phones->System Phone->Settings**.

The menu **Terminals->elmeg System Phones->System Phone->Keys-> Edit** consists of the following fields:

#### Fields in the menu Telephone

Field	Description
<b>Key name</b>	Enter a name for the key to be used as text for the corresponding key when the ID labels are printed.

Field	Description
<b>Key Type</b>	<p>Depending on the model, the telephones feature from 5 to 15 keys on which functions may be assigned over two levels. You can reach the second layer of function keys by pressing the keys twice. This must be done quickly. With S5x0 devices, you can alternately use the <i>Shift</i> function key. With the optional key extensions, you have access to additional twice-assignable function keys.</p> <p>Possible values:</p> <ul style="list-style-type: none"> <li>• <i>Dial Key (Standard)</i></li> <li>• <i>Dial Key (Standard)</i></li> <li>• <i>Dial Key (DTMF)</i></li> <li>• <i>Dial Key (Keypad sequence)</i></li> <li>• <i>Extension Key (User)</i></li> <li>• <i>Extension Key (Team)</i></li> <li>• <i>Trunk Line</i></li> <li>• <i>System Call (Announcement User)</i></li> <li>• <i>System Call (Announcement Team)</i></li> <li>• <i>Login / Log Out, Team</i></li> <li>• <i>System Call (Announcement enable)</i></li> <li>• <i>Receive Intercom Calls</i></li> <li>• <i>System Call (Intercom enable)</i></li> <li>• <i>Boss Key</i></li> <li>• <i>Secretary Key</i></li> <li>• <i>Diversion Secretary</i></li> <li>• <i>Call Forwarding (CFNR)</i></li> <li>• <i>Call Forwarding (CFU)</i></li> <li>• <i>Call Forwarding (CFB)</i></li> <li>• <i>Macro Function</i></li> <li>• <i>Headset Control</i></li> <li>• <i>Automatic Call Pick-up</i></li> <li>• <i>Trunk Group Access</i></li> <li>• <i>Connection Key</i></li> <li>• <i>Hotel Room</i></li> </ul>



Field	Description
	<ul style="list-style-type: none"> <li>• <i>System Parking</i></li> <li>• <i>Agent wrap-up Time</i></li> <li>• <i>Night Mode</i></li> <li>• <i>Shift key (S5x0 only)</i></li> <li>• <i>Parallel call (only S5x0)</i></li> <li>• <i>Station guarding (quiet) (S5x0 only)</i></li> </ul>
<b>Number</b>	<p>Only where <b>Key Type</b> = <i>Dial Key (Standard)</i>, <i>Dial Key (DTMF)</i> and <i>Dial Key (Keypad sequence)</i></p> <p>You can save a number, an MFV sequence or a keypad sequence on every function key. Enter the call number or the code for the DTMF/keypad sequence.</p>
<b>Internal Number</b>	<p>For <b>Key Type</b> = <i>Extension Key (User)</i></p> <p>Select the internal number of a user to be called when this key is pressed.</p> <p>Where <b>Key Type</b> = <i>System Call (Announcement User)</i></p> <p>Select the internal number of a user on whose telephone an announcement shall be made.</p> <p>For <b>Key Type</b> = <i>Login / Log Out, Team</i></p> <p>Select the internal number of a team to be logged into or out of when this key is pressed.</p> <p>For <b>Key Type</b> = <i>Receive Intercom Calls</i></p> <p>Select the internal number of a user with which you wish to conduct simplex operations.</p> <p>For <b>Key Type</b> = <i>Call Forwarding (CFNR)</i>, <i>Call Forwarding (CFU)</i>, <i>Call Forwarding (CFB)</i></p> <p>Select the internal number of a telephone MSN from which the indicated destination number can be forwarded</p> <p>For <b>Key Type</b> = <i>Automatic Call Pick-up</i></p> <p>Select the internal number of this telephone, on which incoming calls shall be automatically accepted.</p>

Field	Description
	<p>For <b>Key Type</b> = <i>Hotel Room</i></p> <p>Select the internal number of a hotel guest.</p> <p>For <b>Key Type</b> = <i>Agent wrap-up Time</i></p> <p>Select the internal number of a user whose post-processing time shall be modified at regular intervals when this key is pressed.</p> <p>For <b>Key Type</b> = <i>Parallel Ringing</i></p> <p>Select the internal number of a user whose phone should also ring when a call goes in to you.</p> <p>For <b>Key Type</b> = <i>MSN Selection Key</i></p> <p>Select that number of your telephone you intend to use.</p>
<b>Automatic Call Pick-up</b>	<p>For <b>Key Type</b> = <i>Automatic Call Pick-up</i></p> <p>Select when a call shall be automatically accepted by the entered internal subscriber.</p> <p>Possible values:</p> <ul style="list-style-type: none"> <li>• <i>Immediately</i>: The call is immediately and automatically accepted.</li> <li>• <i>After 5 seconds</i>: The call is automatically accepted after 5 seconds.</li> <li>• <i>After 10 seconds</i>: The call is automatically accepted after 10 seconds.</li> <li>• <i>After 15 seconds</i> (only <b>S5x0</b>): The call is automatically accepted after 15 seconds.</li> <li>• <i>After 20 seconds</i> (only <b>S5x0</b>): The call is automatically accepted after 20 seconds.</li> <li>• <i>Off</i> (only <b>S5x0</b>): The call is not automatically accepted.</li> </ul>
<b>Team</b>	<p>For <b>Key Type</b> = <i>Extension Key (Team)</i></p> <p>Select the internal number of a team to be called when this key is pressed.</p> <p>Where <b>Key Type</b> = <i>System Call (Announcement Team)</i></p>

Field	Description
	<p>Select the internal number of a team on whose telephone an announcement shall be made.</p> <p>For <b>Key Type</b> = <i>Login / Log Out, Team</i></p> <p>Select the internal number of a team to be logged in/out when this key is pressed.</p>
<b>Trunk Line</b>	<p>Only where <b>Key Type</b> = <i>Trunk Line</i></p> <p>Select the external connection over which an external call shall be set up when this key is pressed.</p>
<b>Number of Secretary Phone</b>	<p>Only if <b>Key Type</b> = <i>Boss Key</i></p> <p>Select the internal number of the secretary telephone. The secretary telephone is called when this key is pressed.</p>
<b>Number of Boss Phone</b>	<p>Only if <b>Key Type</b> = <i>Secretary Key</i></p> <p>Select the internal number of the Boss telephone. The Boss telephone is called when this key is pressed.</p>
<b>Target Number "On no reply"</b>	<p>Only if <b>Key Type</b> = <i>Call Forwarding (CFNR)</i></p> <p>Enter the number to which incoming calls shall be forwarded immediately.</p>
<b>Target Number "Immediate"</b>	<p>Only if <b>Key Type</b> = <i>Call Forwarding (CFU)</i></p> <p>Enter the number to which incoming calls shall be forwarded on busy.</p>
<b>Target Number "On busy"</b>	<p>Only if <b>Key Type</b> = <i>Call Forwarding (CFB)</i></p> <p>Enter the number to which incoming calls shall be forwarded on no reply.</p>
<b>Trunk Group Access</b>	<p>Only if <b>Key Type</b> = <i>Trunk Group Access</i></p> <p>Select the bundle via which an outside call shall be set up.</p>
<b>Waiting Queue</b>	<p>Only for <b>Key Type</b> = <i>Open hold</i></p> <p>Select the queue in which the current call should be held.</p>

### Transfer key

Select the  icon to move configured function keys.

#### Fields in the menu **Key**

Field	Description
<b>Key name</b>	Displays the name of the key.
<b>Key Type</b>	Displays the key type.
<b>Settings</b>	Displays the additional settings with a summary

#### Fields in the menu **Move to**

Field	Description
<b>Phone</b>	Select one of the connected telephones.
<b>Module</b>	Select <i>Telephone</i> or a key extension.
<b>Key</b>	Select the key to which you wish to transfer the configured function.

#### 11.1.1.4 Device Info

In the **Terminals->elmeg System Phones->System Phone->Device Info** menu, the system data read out of the system telephone are displayed.

#### Meaning of the list entries

Description	Meaning
<b>Description</b>	Displays the entered description of the telephone.
<b>Phone Type</b>	Displays the type of telephone.
<b>Serial Number</b>	Displays the serial number of the telephone.
<b>Software Version</b>	Displays the current version of the telephone software.
<b>Release Date and Time</b>	Displays the date and time of the telephone software version.

Description	Meaning
<b>Last Device Configuration</b>	Displays the date and time of the last telephone configuration.
<b>Answering Machine</b>	Displays whether an answering machine module is inserted in the telephone (Yes) or not (No).

### Meaning of Key Extensions

Description	Meaning
<b>Module 1: Type / Serial Number, Module 2: Type / Serial Number, Module 3: Type / Serial Number</b>	Displays the type and serial number of the connected key extension.
<b>Module 1: Software Version, Module 2: Software Version, Module 3: Software Version</b>	Displays the current software version of the connected key extension.

## 11.1.2 elmeg IP

The **Terminals->elmeg System Phones->elmeg IP** menu displays a list of IP telephones. The upper part of the overview displays the manually configured, the lower part displays the automatically detected devices. For an automatic discovery we recommend the use of DHCP. (Activate the option *Use this device as DHCPv4 server* in the menu **Assistants->First steps**.)

If you want to assign a static IP address, you must enter your PABX system as provisioning server (*http://<IP address of the provisioning server>/ eg\_prov*). As soon as a **Description** for the telephone is entered and saved with **OK**, the entry for that device is moved to the upper part of the overview.





#### Note

Key Extension Modules are not discovered automatically, but must be manually configured using the GUI.

If a configured Key Extension System Module is deleted the corresponding function keys are likewise deleted.

Choose the  icon to edit existing entries.

After a short time, the icons  and  are displayed for this device.

After clicking the **Apply** button it takes several seconds until the changes have been transmitted to the respective IP telephone.

Choose the  symbol in order to copy an existing entry. This can be useful if you intend to create an entry that differs only in a few parameters from the already existing entry. In this case, copy the entry and change only the desired parameters.

Select the  button to go to the **elmeg IP** telephone user interface administrator page. This is described in the telephone user guide.

Select the **New** button to manually set up a new IP end device.

Employ automatic provisioning in order to have your PABX system transmit basic telephony parameters to the IP telephones. When using the assistant **First steps** activate the option *elmeg IP1x/DECT* for the field **Transmit Provisioning Server for** in the **Assistants->First steps->Advanced Settings->Add** section. Alternatively, you can create a new entry in the menu **Local Services->DHCP Server->DHCP Configuration->New->Advanced Settings->DHCP Options** and set the fields **Option** = *URL (Provisioning Server)* and **Value** = *http://<IP address of the provisioning server>/eg\_prov*.

To register the handsets you first set the base station to login mode. Then you perform the registering of the handsets on the handsets themselves. To configure the base station in any more detail, you need to use the DECT system's web configurator.

Select the button  to trigger an update of the device's provisioning. If the update is successful, the updated value displays in the **Last seen** column within 10 seconds.



#### Note

If you wish to test whether your base station is correctly configured and accessible, select the button  and check whether an updated value is displayed within 10 seconds in the **Last seen** column.

### 11.1.2.1 General

In the menu **Terminals->elmeg System Phones->elmeg IP->General**, you make the basic settings for an IP telephone.

The **Terminals->elmeg System Phones->elmeg IP->General** menu consists of the following fields:

#### Fields in the menu **Basic Settings**

Field	Description
<b>Description</b>	To clearly identify the telephone in the system, enter a description for the telephone.
<b>Phone Type</b>	Displays the type of your IP telephone.  Possible values: <ul style="list-style-type: none"> <li>• <i>elmeg IP120</i></li> <li>• <i>elmeg IP130</i></li> <li>• <i>elmeg IP140</i></li> </ul>
<b>Location</b>	Select the location of the telephone. You define locations in the <b>VoIP-&gt;Settings-&gt;Locations</b> menu. Depending on the setting in this menu, default behaviour for registration of VoIP subscribers for which no location should be defined is displayed for selection.  Possible values: <ul style="list-style-type: none"> <li>• <i>Not defined (Unrestricted Registration)</i>: No location is defined. According to set default behaviour, the subscriber is nevertheless registered.</li> <li>• <i>Not defined (No Registration)</i>: No location is defined. According to set default behaviour, the subscriber is not registered.</li> <li>• <i>Not defined (Registration for Private Networks Only)</i>: No location is defined. According to set default behaviour, the subscriber is only registered if located in a private network.</li> <li>• <i>&lt;Location&gt;</i>: A defined location is selected. The subscriber is only registered if at this location.</li> </ul>
<b>MAC Address</b>	Shows the MAC address of the telephone.
<b>IP/MAC Binding</b>	Displays the IP address automatically assigned by DHCP.  Here you have the option of permanently assigning the dis-

Field	Description
	<p>played IP address to the device with the displayed MAC address.</p> <p>This option should be activated to enable quick re-login after a functional fault.</p>

### Key extension modules

The key extension module **elmeg T100** (available for **elmeg IP120**, **IP130** und **IP140**) features 14 keys with LEDs, which you can configure as function keys. **elmeg IP120** can be expanded by up to two extension modules, **elmeg IP 130** and **IP140** support up to three cascaded modules. The operation of a thirs extension mosdule requires the connection of a power supply.

### Fields n the menu Extensions

Field	Description
<b>Ext. Module No 1 - 3</b> (depends on <b>Phone Type</b> )	<p>Displays if you are operatnig the IP telephone with an key extension module. Only the number of modules supported by the respective phone type is offered for configuration.</p> <p>Possible values:</p> <ul style="list-style-type: none"> <li>• <b>Not available</b></li> <li>• <b>Available</b></li> </ul>

The menu **Advanced Settings** consists of the following fields:

### Fields in the menu Further Settings

Field	Description
<b>No Hold and Retrieve</b>	<p>The performance features hold a call and retrieve a held call are not available on certain telephones.</p> <p>The function is activated by selecting <i>Enabled</i>.</p> <p>The function is disabled by default.</p>

### Fields in the menu Codec Settings

Field	Description
<b>Codec Profile</b>	Select the Codec profile to be used. Codec profiles are configured in the <b>VoIP-&gt;Settings-&gt;Codec Profiles</b> menu.



### 11.1.2.2 Numbers

In the menu **Terminals->elmeg System Phones->elmeg IP->Numbers** you assign an IP telephone up to twelve internal phone numbers using **Add**.

The available internal phone numbers are created under **Numbering->User Settings->Users->New**.

You can delete assigned numbers from the list with .

#### Values in the list Number Settings

Field	Description
<b>Connections Nr.</b>	Shows the serial number of the connection.
<b>Internal Number</b>	Displays the assigned internal number.
<b>Displayed Description</b>	Displays the description that will be displayed on the IP telephone's display.
<b>User</b>	Displays the user's name.

### 11.1.2.3 Keys / T100

The menu **Terminals->elmeg System Phones->elmeg IP->Keys** displays the configuration of your system telephone's keys.



#### Note

You can configure the key assignment either through your PABX system or on the telephone itself. We recommend using your PABX system for this, since it overwrites the telephone configuration.

You can avoid the overwriting for individual keys that have already been configured on the telephone by choosing *Not configured* on the PABX system.

Your telephone is equipped with several function keys that allow the assignment of different functions. The functions available for programming are different across different types of telephones.

#### Values in the list Keys

Field	Description
<b>Key</b>	Displays the name of the key.
<b>Label Description</b>	Displays the configured key name. This appears on the labelling page (label strips).
<b>Key Type</b>	Displays the key type.
<b>Settings</b>	Displays the additional settings with a summary

**Print** allows you to print out a label sheet for the description field of your system phone or key extension.

### Edit

Choose the  icon to edit existing entries. In the pop-up menu, you configure the functions of your system telephone keys.

You can use the following functions with system telephones:

- *Dial Key (Standard)*: You can store a number on each function key. External numbers have to be prefixed by the exchange code *0if no automatic outside line* has been configured for your **Class of Service** on the telephone.
- *Dial Key (DTMF)*: You can store a DTMF sequence on every function key.
- *Extension Key (User)*: You can set up dialling to an internal extension using a line key. After pressing the corresponding key, hands free is switched on and the internal extension entered is selected. If a call is signalled on the internal extension you have entered, you can pick this up by pressing the line key.
- *MSN Selection Key*: Assigns a specific connection (i.e. a specific SIP account) to the function key. You can use this key to initiate a call via this connection, or you can accept a call coming in via this connection. The key flashes if a call is received, it is lit if the connection is busy. Select the desired connection. All configured connections are available. Configure SIP accounts exclusively on your PABX system.
- *Call Forwarding (enable)*: Assigns activating or deactivating a call forwarding that has been configured on the telephone. You can only store a single call forwarding on the device; it is applied to all calls.
- *System Parking (Open Enquiry)*: The called extension enters an enquiry and dials a code. The telephone is now open for additional operations like e.g. an announcement. A second subscriber can accept the call by picking up the receiver and dialling the code corresponding to the call. The codes are determined by the PABX, but can also be assigned to the functions keys of one or more system phones. If a call is put into open enquiry by

pressing a function key, this is indicated by the flashing of the respective function key LED on all system phones with a corresponding configuration. Pressing the function key accepts the call. This function is only available if a call has been parked.

- *XML-Content*(only for IP140/130): Assigns an URL to the function key. You can, e.g., store customer-specific menus and temporarily show them on the display of your telephone. This function is currently not supported by your PABX system.
- *Next call anonymous*: For the next call the called party will no see your MSN.
- *Menu - Call Forwarding*: Assigns the menu item **Call Forwarding** in the display menu of your telephone to the function key. You can configure the call forwarding specifics.
- *Menu - Resource Directory*(only for IP140/130): Assigns the menu item **Media-Pool** in the display menu of your telephone to the function key. You can manage images used as screen saver, caller icons for phone directory entries and ring tones. Moreover, you can monitor the capacity of the pool.
- *Menu - Internet Radio*(only for IP140/130): Assigns the menu item **Internet Radio** in the display menu of your telephone to the function key. You can tune in to the last selected radio station or select a different one. This option has to be activated in the menu of the telephone, too.
- *Not configured*: The function key is managed by the telephone itself and not by the PABX system. This options locks the key for the provisioning by your PABX system.

The menu **Terminals->elmeg System Phones->elmeg IP->Keys->Edit** consists of the following fields:

#### Fields in the menu Telephone

Field	Description
<b>Key name</b>	Enter a name for the key to be used as text for the corresponding key when the ID labels are printed.
<b>Key Type</b>	<p>Depending on the model, telephones have seven or 14 keys that can have functions assigned to them. Optional key extension modules extend the number of available functions keys.</p> <p>Possible values:</p> <ul style="list-style-type: none"> <li>• <i>Dial Key (Standard)</i></li> <li>• <i>Dial Key (DTMF)</i></li> <li>• <i>Extension Key (User)</i></li> <li>• <i>MSN Selection Key</i></li> <li>• <i>Call Forwarding (enable)</i></li> <li>• <i>System Parking</i></li> </ul>

Field	Description
	<ul style="list-style-type: none"> <li>• <i>XML-Content</i></li> <li>• <i>Next call anonymous</i></li> <li>• <i>Menu - Call Forwarding</i></li> <li>• <i>Menu - Resource Directory</i></li> <li>• <i>Menu - Internet Radio</i></li> <li>• <i>Not configured</i></li> </ul>
<b>Internal MSN</b>	<p>Only for <b>Key Type</b> = <i>Dial Key (Standard)</i>, <i>Extension Key (User)</i>, <i>MSN Selection Key</i>, <i>Call Forwarding (enable)</i> or <i>System Parking</i></p> <p>You can select one of the internal MSNs configured in the menu <b>Terminals-&gt;elmeg System Phones-&gt;elmeg IP-&gt;Numbers</b>.</p>
<b>Number</b>	<p>Only for <b>Key Type</b> = <i>Dial Key (Standard)</i> or <i>Dial Key (DTMF)</i></p> <p>You can save a number or a DTMF sequence to any function key. Specify the number or the characters for the DTMF sequence.</p>
<b>Internal Number</b>	<p>Only for <b>Key Type</b> = <i>Extension Key (User)</i></p> <p>Select the internal number of the subscriber that is to be called when pressing this key.</p>
<b>Pick-Up Code</b>	<p>Only for <b>Key Type</b> = <i>Extension Key (User)</i></p> <p>The code that is required for the busy lamp field to allow you picking up a call on an IP telephone when the LED is flashing.</p> <p>The default value is #0.</p>
<b>Waiting Queue</b>	<p>Only for <b>Key Type</b> = <i>System Parking (Open Enquiry)</i></p> <p>Select the waiting queue to which the current connection is to be added.</p>
<b>URL</b>	<p>Only for <b>Key Type</b> = <i>XML-Content</i></p> <p>For this function you can store the URL to a server which hosts the desired information. This function is currently not supported by your PABX system.</p>

### Transfer key

Select the  icon to move configured function keys.

#### Fields in the menu Key

Field	Description
Key name	Displays the name of the key.
Key Type	Displays the key type.
Settings	Displays the additional settings with a summary

#### Fields in the menu Move to

Field	Description
Phone	Select one of the connected telephones.
Module	Select <i>Telephone</i> or a key extension.
Key	Select the key to which you wish to transfer the configured function.

### 11.1.2.4 Settings

In the **Terminals->elmeg System Phones->elmeg IP->Settings** menu you can reset the telephone's administrator password.

The **Terminals->elmeg System Phones->elmeg IP->Settings** menu consists of the following fields:

#### Fields in the menu System Phone

Field	Description
Admin Password	<p>Select whether the administrator password should be reset.</p> <p>The function is activated by selecting <i>Enabled</i>.</p> <p>The function is disabled by default.</p> <p>As soon as you select the <b>OK</b> button, the password is reset to the default setting.</p>

Field	Description
<b>Display Language</b>	<p>Select the display language for your telephone.</p> <p>Possible values:</p> <ul style="list-style-type: none"> <li>• <i>Deutsch</i></li> <li>• <i>Dutch</i></li> <li>• <i>English</i></li> <li>• <i>Italian</i></li> <li>• <i>Spanish</i></li> <li>• <i>French</i></li> <li>• <i>Portugues</i></li> <li>• <i>Česko</i></li> <li>• <i>Greek</i></li> <li>• <i>Polish</i></li> <li>• <i>Romanian</i></li> <li>• <i>Slovak</i></li> </ul>



### 11.1.3 elmeg DECT

The menu **Terminals->elmeg System Phones->elmeg DECT** displays the base stations of the connected DECT single-cell and multi-cell systems.

All base stations that are connected are automatically detected and listed in the lower part of the overview. For an automatic discovery we recommend the use of DHCP. (Activate the option *Use this device as DHCPv4 server* in the menu **Assistants->First steps**.)

If you want to assign a static IP address, you must enter your PABX system as provisioning server (*http://<IP address of the provisioning server>/ eg\_prov*).

As soon as a **Description** for the base station is entered and saved with **OK**, the entry for that device is moved to the upper part of the overview.

After a short time, the icons  and  are displayed for this device.

Choose the  icon to edit existing entries.

After clicking the **Apply** button it takes several seconds until the changes have been transmitted to the respective device.

Select the **New** button to manually set up a new base station.

Select the button  to go to the base station's Web configurator. This is described in the user guide for the relevant DECT system.

In order to be able to use automatic provisioning, click the  icon again and add the respective numbers.

Use automatic provisioning to have your PABX system transfer elementary telephony parameters to the DECT system. If you want to use the assistant **First Steps** to do this, you activate the value *elmeg IP1x/DECT* under **Assistants->First steps->Advanced Settings->Add** in the field **Transmit Provisioning Server for** . Alternatively, you can create a new entry in the menu **Local Services->DHCP Server->DHCP Configuration->New->Advanced Settings->DHCP Options** and set the fields **Option** = *URL (Provisioning Server)* and **Value** = *http://<IP address of the provisioning server>/eg\_prov* .

To register the handsets you first set the base station to login mode. Then you perform the registering of the handsets on the handsets themselves. To configure the base station in any more detail, you need to use the DECT system's web configurator.

Select the button  to trigger an update of the device's provisioning. If the update is successful, the updated value displays in the **Last seen** column within 10 seconds.



#### Note

If you wish to test whether your base station is correctly configured and accessible, select the button  and check whether an updated value is displayed within 10 seconds in the **Last seen** column.



#### Note

If you wish to change the language currently used with a DECT single-cell system, the system has to be connected to the provisioning server of the PABX. You require an installed SD card (if supported by you device). All languages to be deployed need to be stored on the SD card. Single-cell systems load a required language from the SD card on demand.

### 11.1.3.1 General

In the menu **Terminals->elmeg System Phones->elmeg DECT->General** you make the basic settings for base stations.

The **Terminals->elmeg System Phones->elmeg DECT->General** menu consists of the following fields:

#### Fields in the menu **Basic Settings**

Field	Description
<b>Description</b>	To clearly identify the base station in the system, enter a description for the telephone.
<b>Phone Type</b>	Displays the type of base station.  Possible values: <ul style="list-style-type: none"> <li>• <i>elmeg DECT150</i></li> <li>• <i>elmeg DECT200</i></li> </ul>
<b>Location</b>	Select the location of the base station. You define locations in the <b>VoIP-&gt;Settings-&gt;Locations</b> menu. Depending on the setting in this menu, default behaviour for registration of VoIP subscribers for which no location should be defined is displayed for selection.  Possible values: <ul style="list-style-type: none"> <li>• <i>Not defined (Unrestricted Registration)</i>: No location is defined. According to set default behaviour, the subscriber is nevertheless registered.</li> <li>• <i>Not defined (No Registration)</i>: No location is defined. According to set default behaviour, the subscriber is not registered.</li> <li>• <i>Not defined (Registration for Private Networks Only)</i>: No location is defined. According to set default behaviour, the subscriber is only registered if located in a private network.</li> <li>• <i>Location</i>: A defined location is selected. The subscriber is only registered if at this location.</li> </ul>
<b>MAC Address</b>	Shows the MAC address of the base station.
<b>IP/MAC Binding</b>	Displays the IP address automatically assigned by DHCP.  Here you have the option of permanently assigning the displayed IP address to the base station with the displayed MAC



Field	Description
	address.  This option should be activated to enable quick re-login after a functional fault.

The menu **Advanced Settings** consists of the following fields:

#### Fields in the menu Further Settings

Field	Description
<b>No Hold and Retrieve</b>	The performance features hold a call and retrieve a held call are not available on certain telephones.  The function is activated by selecting <i>Enabled</i> .  The function is disabled by default.

#### Fields in the menu Codec Settings

Field	Description
<b>Codec Profile</b>	Select the Codec profile to be used. Codec profiles are configured in the <b>VoIP-&gt;Settings-&gt;Codec Profiles</b> menu.

### 11.1.3.2 Numbers

In the menu **Terminals->elmeg System Phones->elmeg DECT->Numbers** you assign **Internal Numbers** to the mobile parts. You can select from the numbers that you have created for this purpose under **Numbering->User Settings->Users**.

The system automatically assigns a serial number, the **Mobile Number**, to each mobile part so that you can identify the device. You can then use **Add** to assign a **Internal Number** to a mobile part from the list.

You can delete assigned numbers with .

#### Values in the list Numbers

Field	Description
<b>Mobile Number</b>	Displays the serial number of the mobile part. This number is permanently assigned to the mobile part so that it can be uniquely identified.

Field	Description
<b>Internal Number</b>	Displays the assigned internal number.
<b>Displayed Description</b>	Displays the description entered for the internal number. In standby mode this description is shown on the mobile part's display.
<b>User</b>	Displays the user's name.

### 11.1.3.3 Settings

In the **Terminals->elmeg System Phones->elmeg DECT->Settings** menu you can reset the administrator password for the base station.

The **Terminals->elmeg System Phones->elmeg DECT->Settings** menu consists of the following fields:

#### Fields in the menu Basic Settings

Field	Description
<b>Admin Password</b>	<p>Select whether the administrator password should be reset.</p> <p>The function is activated by selecting <i>Enabled</i>.</p> <p>The function is disabled by default.</p> <p>As soon as you select the <b>OK</b> button, the password is reset to the default setting.</p>

## 11.2 Other phones

In this menu, you perform assignment of configured internal numbers to the terminals and set additional functions according to terminal type.

Terminals of the corresponding category (VoIP, ISDN, or analog) are sorted alphabetically in the **Description** column. Click the column title of any other column to sort entries in ascending or descending order.

## 11.2.1 VoIP

In the **Terminals->Other phones->VoIP** menu, you configure the connected VoIP terminals. For example, you perform assignment of a configured internal number.

Specific instructions for configuring VoIP, see [VoIP - Configuration example \(a smartphone as an internal VoIP telephone\)](#) on page 204.

### 11.2.1.1 Edit or New

Choose the  icon to edit existing entries. Select the **New** button to add VoIP terminals.

The **Terminals->Other phones->VoIP->New** menu consists of the following fields:

#### Fields in the menu Basic Settings

Field	Description
<b>Description</b>	Enter a description for the IP telephone.
<b>Location</b>	<p>Select the location of the telephone. You define locations in the <b>VoIP-&gt;Settings-&gt;Locations</b> menu. Depending on the setting in this menu, default behaviour for registration of VoIP subscribers for which no location should be defined is displayed for selection.</p> <p>Possible values:</p> <ul style="list-style-type: none"> <li>• <i>Not defined (Unrestricted Registration)</i>: No location is defined. According to set default behaviour, the subscriber is nevertheless registered.</li> <li>• <i>Not defined (No Registration)</i>: No location is defined. According to set default behaviour, the subscriber is not registered.</li> <li>• <i>Not defined (Registration for Private Networks Only)</i>: No location is defined. According to set default behaviour, the subscriber is only registered if located in a private network.</li> <li>• <i>&lt;Location&gt;</i>: A defined location is selected. The subscriber is only registered if at this location.</li> </ul>

#### Fields in the menu Number Settings

Field	Description
<b>Internal Numbers</b>	<p>Select the internal number for this terminal. You can define several internal numbers.</p> <p>Possible values:</p> <ul style="list-style-type: none"> <li>• <i>No free Extension Available</i>: All configured internal numbers are already in use. First configure another user with additional numbers.</li> <li>• <i>&lt;Internal Number&gt;</i>: Select one of the existing numbers of the configured users.</li> </ul>

The menu **Advanced Settings** consists of the following fields:

#### Fields in the menu **SIP Client Settings**

Field	Description
<b>SIP Client Mode</b>	<p>Select whether a <i>dynamic</i> SIP client or a <i>static</i> SIP client is to be used.</p> <p>Possible values:</p> <ul style="list-style-type: none"> <li>• <i>Dynamic</i> (default value): Your device (e. g. a standard SIP telephone) runs a SIP registration to tell the system its (dynamic) IP address.</li> <li>• <i>Static</i>: The system accepts an incoming call from a (statically configured) SIP client without this client needing to have been registered beforehand, if the IP address of the client matches the IP address entered under <b>SIP Client IP Address</b>. This mode is used by, for example, the Microsoft Office Communications Server and other unified communication servers.</li> </ul>
<b>SIP Client IP Address</b>	<p>Only for <b>SIP Client Mode</b> = <i>Static</i>.</p> <p>Enter the static local IP address of the SIP client.</p>
<b>Port Number</b>	<p>Only for <b>SIP Client Mode</b> = <i>Static</i>.</p> <p>Enter the number of the port to be used for connection.</p> <p>A 5 digit sequence is possible. For example, port <i>5065</i> must be entered for connection to a Microsoft Exchange Communication Server.</p>

Field	Description
<b>Transport Protocol</b>	<p>Only for <b>SIP Client Mode</b> = <i>Static</i>.</p> <p>Select the transport protocol for the connection.</p> <p>Possible values:</p> <ul style="list-style-type: none"> <li>• <i>UDP</i> (default value)</li> <li>• <i>TCP</i></li> </ul> <p>For example, the <i>TCP</i> protocol must be entered for connection to a Microsoft Exchange Communication Server.</p>

#### Fields in the menu **Codec Settings**

Field	Description
<b>Codec Profile</b>	<p>Select the codec profile to be used if the connection is over a VoIP line. Codec profiles are configured in the <b>VoIP-&gt;Settings-&gt;Codec Profiles</b> menu.</p>

#### Fields in the menu **Further Settings**

Field	Description
<b>Multiple SIP Connections (Sub-Exchange)</b>	<p>Select whether multilinks shall be allowed from this terminals.</p> <p>Operation as subsystem: Only in case of connection of a subsystem to a system Here, with a disabled performance feature, only a connection via the subscriber SIP registration is possible. If a second call comes in, it is accepted and the existing call is held. With an enabled performance feature, several SIP connections are possible over the same login. If the performance feature is enabled for as system without subsystem, two simultaneous calls on the phone are not connected to each other after the receiver is replaced but released, for example. Here, the performance feature should not be set.</p> <p>The function is activated by selecting <i>Enabled</i>.</p> <p>The function is disabled by default.</p>
<b>No Hold and Retrieve</b>	<p>The performance features "hold a call" and "retrieve a held call" are not available on certain telephones.</p> <p>The function is activated by selecting <i>Enabled</i>.</p>

Field	Description
	The function is disabled by default.
<b>T.38 FAX support</b>	<p>Select if you want to transmit FAX documents via Voice over IP using the T.38 standard.</p> <p><i>Enabled</i> activates T.38 support.</p> <p>Per default, the function is disabled.</p> <p>If the function is disabled, FAX documents are transmitted using G.711.</p>

## 11.2.2 VoIP - Configuration example (a smartphone as an internal VoIP telephone)

### Requirements

- An **be.IP**
- A configured with the Assistents **Initial operation** SIP connection *DeutschlandLAN*
- A taken with the Assistents in operation WLAN access point
- An Smartphone e.g. **iPhone 4**
- Available connection to the WLAN access poin the **be.IP**
- SIP app, Media5-fone, installed on the smartphone



### Note

Please note that the scope of settings and supported functions may vary with different versions of smartphone operating systems (iOS, Android) and the smartphone app, Media5-fone.

### Example scenario

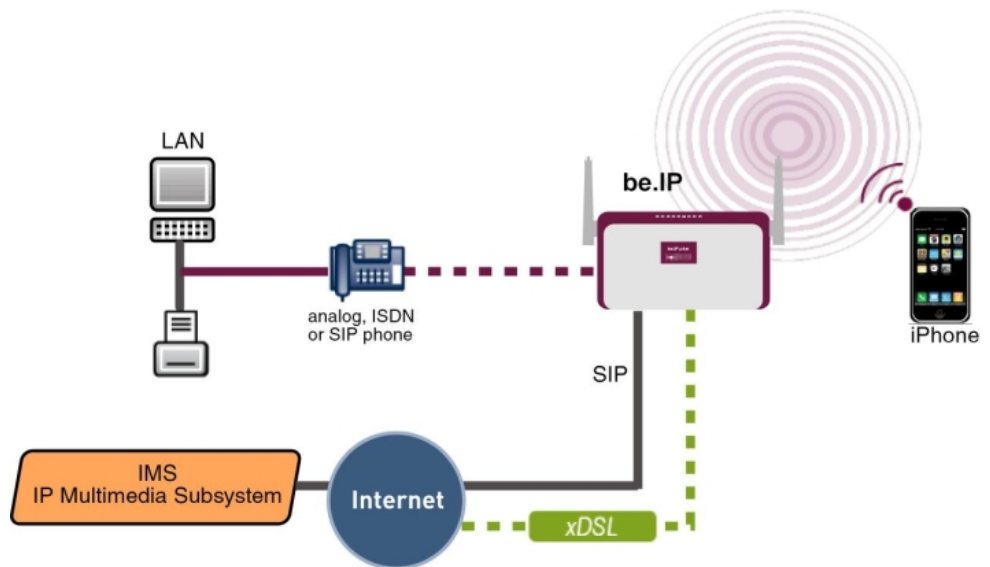

### Configuration target

Integration of a smartphone as an internal VoIP phone

### Overview of Configuration Steps

#### Creating a User and integrate Smartphone

Field	Menu	Value
Name	Ne Assistants->Telephony->Users->w	e.g. <i>User 33 (iPhone)</i>
Description	Ne Assistants->Telephony->Users->w	e.g. <i>iPhone 33</i>
Password	Ne Assistants->Telephony->Users->w	e.g. <i>1234</i>
Displayed Description	Ne Assistants->Telephony->Users->w->Add	e.g. <i>#33 iPhone</i>
Internal Number	Ne Assistants->Telephony->Users->w->Add	e.g. <i>iPhone</i>

Field	Menu	Value
Description	Terminals->Other phones->VoIP->New	e.g. 33
Internal Numbers	Terminals->Other phones->VoIP->New	33 (#33 iPhone)

#### Configuration of the smartphone app using the example Media5-fone

Field	Menu	Value
Title	New SIP Account -> Manual Settings	e.g. <i>be.IP</i>
User Name	New SIP Account -> Manual Settings	e.g. 33
Password	New SIP Account -> Manual Settings	e.g. 1234
Address	New SIP Account -> Manual Settings-> Server	e.g. 192.168.0.250
Port	New SIP Account -> Manual Settings-> Server	5060
Activating a proxy	New SIP Account -> Manual Settings-> Server	<i>Disabled</i>
SIP Transport	New SIP Account -> Manual Settings-> Server	<i>UDP</i>
Switch SRTP	New SIP Account -> Manual Settings-> Server	<i>Switched off</i>
Mailbox Number	New SIP Account -> Manual Settings ->Advanced	e.g. 50
Write MWI	New SIP Account -> Manual Settings ->Advanced	<i>Enabled</i>
DTMF Method	New SIP Account -> Manual Settings ->Advanced	<i>RTP Input Signal Band</i>
Codecs Wi-Fi	New SIP Account -> Manual Settings ->Advanced	<i>G.711 μLaw, G.711 aLaw</i>

#### Configuration of external number

Field	Menu	Value
International Prefix / Country Code	Assistants->Telephony->First steps	e.g. 00 / 49
National Prefix / City	Assistants->Telephony->First	e.g. 0 / 911



Field	Menu	Value
<b>Code</b>	<b>steps</b>	
<b>Connection Type</b>		<i>SIP Provider</i>

Field	Menu	Value
	<b>New</b>	
<b>Type</b>		<i>DeutschlandLAN</i>

Field	Menu	Value
	<b>New</b>	
<b>Description</b>		e.g. <i>SIP Connection</i>

Field	Menu	Value
	<b>New-&gt;Next</b>	
<b>Single Number (MSN)</b>		e.g. 111111

Field	Menu	Value
	<b>New-&gt;Next</b>	
<b>Description</b>		e.g. <i>SIP number 1</i>

Field	Menu	Value
	<b>New-&gt;Next</b>	
<b>Connection Type</b>		<i>SIP Provider</i>

Field	Menu	Value
	<b>New</b>	
<b>Type</b>		<i>DeutschlandLAN</i>

Field	Menu	Value
	<b>New</b>	
<b>Name</b>		e.g. <i>SIP Connection</i>



Field	Menu	Value
	<b>New-&gt;Next</b>	
<b>Single Number (MSN)</b>		e.g. 222222

Field	Menu	Value
	<b>New-&gt;Next</b>	
<b>Description</b>		e.g. <i>SIP number 2</i>

Field	Menu	Value
	<b>New-&gt;Next</b>	
<b>Connection Type</b>		<i>SIP Provider</i>

Field	Menu	Value
	<b>New</b>	
<b>Type</b>		<i>DeutschlandLAN</i>

Field	Menu	Value
	<b>New</b>	
<b>Name</b>		e.g. <i>SIP Connection</i>

Field	Menu	Value
	<b>New-&gt;Next</b>	
<b>Single Number (MSN)</b>		e.g. 333333





Field	Menu	Value
	<b>New-&gt;Next</b>	
<b>Description</b>		e.g. <i>SIP number 3</i>

Field	Menu	Value
	New->Next	

#### Signalling of incoming calls

Feld	Menü	Wert
Assignment Type	Assistants->Telephony->Call Distribution-> <111111> 	Team
Team	Assistants->Telephony->Call Distribution-> <111111> 	e.g. 40 (Team global)
Assignment Type	Assistants->Telephony->Call Distribution-> <222222> 	Extension
Assignment	Assistants->Telephony->Call Distribution-> <222222> 	e.g. 20 (Sys Tel 20)
Assignment Type	Assistants->Telephony->Call Distribution-> <333333> 	Extension
Assignment	Assistants->Telephony->Call Distribution-> <333333> 	e.g. 33 (#33 iPhone)

#### Signalling of specific number

Feld	Menü	Wert
Trunk	Numbering->User Settings->Users-> <User 33> (iPhone)  ->Outgoing Signalisation->Internal Number-><33> 	SIP Connection
Outgoing Signalisation	Numbering->User Settings->Users-> <User 33> (iPhone)  ->Outgoing Signalisation->Internal Number-><33> 	e.g. 333333

#### Change registration timer in Media5-fone

Field	Menu	Value
Reg. Timer (Sec)	More -> Settings -> Configure SIP Accounts -> be.IP -> Server -> Reg. Timer (Sec)	e.g. 1200

#### Configuration of codecs in Media5-fone

Field	Menu	Value
DTMF Method	More -> Settings -> Configure SIP	RTP Input Signal



Field	Menu	Value
	<b>Accounts -&gt; be.IP -&gt; Advanced</b>	<i>Band</i>
<b>Codec Wi-Fi</b>	<b>More -&gt; Settings -&gt; Configure SIP Accounts -&gt; be.IP -&gt; Advanced</b>	e.g. <i>G.711 µLaw, G.711 aLaw</i>

### 11.2.3 ISDN

In the **Terminals->Other phones->ISDN** menu, you configure the connected ISDN terminals. For example, you perform assignment of a configured internal number.

Only for compact systems. Two predefined entries are displayed:

Description	Interface	Terminal Type	Internal Numbers	License Allocation
ISDN 1	S0 1	Telephone	30	Enabled
ISDN 2	S0 2	Telephone	35	Enabled

#### 11.2.3.1 Edit or New

Choose the  icon to edit existing entries. Select the **New** button to add ISDN terminals.

The **Terminals->Other phones->ISDN->New** menu consists of the following fields:

#### Fields in the Basic Settings menu

Field	Description
<b>Description</b>	Enter a description for the ISDN telephone.
<b>Interface</b>	Select the interface to which the ISDN telephone shall be connected.

#### Fields in the Basic Phone Settings menu

Field	Description
<b>Terminal Type</b>	Select the terminal type.  Possible values: <ul style="list-style-type: none"> <li>• <i>Telephone</i> (default value)</li> <li>• <i>Answering Machine</i></li> <li>• <i>Voice Mail</i></li> <li>• <i>Emergency Phone</i></li> </ul>

Field	Description
<b>Internal Numbers</b>	<p>Select the internal number for this terminal You can define several internal numbers.</p> <p>Possible values:</p> <ul style="list-style-type: none"> <li>• <i>No free Extension Available</i>: All configured internal numbers are already in use. First configure another user with additional numbers.</li> <li>• <i>&lt;Internal Number&gt;</i>: Select one of the existing numbers of the configured users.</li> </ul>

## 11.2.4 analog

In the **Terminals->Other phones->Analogue** menu, you configure the connected analogue terminals. For example, you perform assignment of a configured internal number.

Only for compact systems: Two predefined entries are displayed:

Description	Interface	Terminal Type	Internal Numbers	License Allocation
a/b 1	FXS 1	Telephone	10	Enabled
a/b 2	FXS 2	Telephone	11	Enabled
a/b 3	FXS 3	Telephone	12	Enabled
a/b 4	FXS 4	Multi Function Device/Telefax	13	Enabled

### 11.2.4.1 Edit or New

Choose the  icon to edit existing entries. Select the **New** button to add analog terminals.

Choose the  icon to copy existing entries. Copying an entry can prove useful if you wish to create an entry only distinguished by a few parameters from an existing entry. In this case, you copy the entry and modify the desired parameters.

The **Terminals->Other phones->Analogue->Edit** menu consists of the following fields:

#### Fields in the Basic Settings menu

Field	Description
<b>Description</b>	Enter a description for the analogue telephone.

Field	Description
<b>Interface</b>	Select the interface to which the telephone shall be connected.

#### Fields in the **Basic Phone Settings** menu

Field	Description
<b>Terminal Type</b>	<p>Select the terminal type.</p> <p>Possible values:</p> <ul style="list-style-type: none"> <li>• <i>Multi Function Device/Telefax</i></li> <li>• <i>Telephone</i></li> <li>• <i>Modem</i></li> <li>• <i>Answering Machine</i></li> <li>• <i>Emergency Phone</i></li> </ul>
<b>Internal Number</b>	<p>Select the internal number for this terminal.</p> <p>Possible values:</p> <ul style="list-style-type: none"> <li>• <i>No free Extension Available</i>: The configured internal number is already in use. First configure another user with additional numbers.</li> <li>• <i>&lt;Internal Number&gt;</i>: Select one of the existing numbers of the configured users.</li> </ul>

#### Fields in the **Phone Settings** menu

Field	Description
<b>Call Waiting</b>	<p>Select whether call waiting shall be allowed for this device.</p> <p>The function is activated by selecting <i>Enabled</i>.</p> <p>The function is enabled by default.</p>
<b>Do not Disturb</b>	<p>Select whether you wish to use the call protection (do not disturb) performance feature.</p> <p>With this performance feature, you can enable call signalling to your terminal. Analogue terminals use system code numbers for this.</p> <p>Possible values:</p>

Field	Description
	<ul style="list-style-type: none"> <li>• <i>Internal Calls not signaled</i></li> <li>• <i>External Calls not signaled</i></li> <li>• <i>No Calls signaled</i></li> </ul>

The menu **Advanced Settings** consists of the following fields:

#### Fields in the **CLIP Settings** menu

Field	Description
<b>Show incoming Number (CLIP)</b>	<p>Select whether the subscriber's number shall be transmitted.</p> <p>The function is activated by selecting <i>Enabled</i>.</p> <p>The function is enabled by default.</p>
<b>Show Date and Time</b>	<p>Only for <b>Show incoming Number (CLIP)</b> <i>Enabled</i></p> <p>Select whether the time and date should be taken from your PABX system and displayed on the telephone.</p> <p>The function is activated by selecting <i>Enabled</i>.</p> <p>The function is enabled by default.</p>
<b>Show incoming Name (CNIP)</b>	<p>Only for <b>Show incoming Number (CLIP)</b> <i>Enabled</i></p> <p>Select whether the caller's number shall be displayed. The caller's number can be displayed if an entry exists in the system telephone book.</p> <p>The function is activated by selecting <i>Enabled</i>.</p> <p>The function is enabled by default.</p>
<b>Show incoming waiting Number (CLIP off Hook)</b>	<p>Only for <b>Show incoming Number (CLIP)</b> <i>Enabled</i></p> <p>Select whether the number of a caller waiting during an existing call shall be displayed.</p> <p>The function is activated by selecting <i>Enabled</i>.</p> <p>The function is enabled by default.</p>

#### Fields in the **Further Settings** menu

Field	Description
<b>Show new Messages (MWI)</b>	<p>Only for <b>Show incoming Number (CLIP)</b> <i>Enabled</i></p> <p>Select whether new messages shall be signalled on a voice mail system.</p> <p>The function is activated by selecting <i>Enabled</i>.</p> <p>The function is enabled by default.</p>
<b>Transmit Charges Pulses</b>	<p>Select whether the system shall generate charge pulses for the terminal from the ISDN network charge information. For this purpose, you can define the charge impulse at 12 kHz or 16 kHz.</p> <p>Possible values:</p> <ul style="list-style-type: none"> <li>• <i>Off</i>: Charge information from the ISDN network is not transmitted.</li> <li>• <i>12 kHz</i></li> <li>• <i>16 kHz</i></li> </ul> <p>The default value is <i>16 kHz</i></p>
<b>FXS Ringing Frequency</b>	<p>Call signalling in analogue terminals occurs by configuring a call switching voltage at the called analogue connections. This call switching voltage is converted into a specific ring tone by the analogue terminal. In the system, for the analogue connections you can set a call switching voltage with a frequency of <i>25 Hz</i> or <i>50 Hz</i>.</p> <p>The default value is <i>50 Hz</i>.</p>
<b>Flash Time for DTMF Dialling</b>	<p>When operating analogue terminals with the multifrequency code dialling method, you can set the flashtime that the system detects as maximum flash length. If the terminal flash is longer than the defined period, "replaced receiver" is detected.</p> <p>Values from <i>100 ms</i> to <i>1000 ms</i> are possible.</p> <p>The default value is <i>400 ms</i>.</p>

## 11.2.5 CAPI

If your device supports CAPI, you configure the connected CAPI terminals in the menu **Terminals->Other phones->CAPI**. For example, you perform assignment of a configured internal number.

### 11.2.5.1 Edit or New

Choose the  icon to edit existing entries. Select the **New** button to add CAPI terminals.

The **Terminals->Other phones->CAPI->New** menu consists of the following fields:

#### Fields in the menu Basic Settings

Field	Description
Description	Enter a description for the CAPI telephone.

#### Fields in the menu Basic Phone Settings

Field	Description
Internal Numbers	<p>Use <b>Add</b> to select the internal number for this terminal. You can define several internal numbers.</p> <p>Possible values:</p> <ul style="list-style-type: none"> <li>• <i>No free Extension Available</i>: All configured internal numbers are already in use. First configure another user with additional numbers.</li> <li>• <i>&lt;Internal Number&gt;</i>: Select one of the existing numbers of the configured users.</li> </ul>

## 11.3 Overview

### 11.3.1 Overview

In the **Terminals->Overview->Overview** menu, you get an overview of all configured terminals.

#### Values in the Overview list

Field	Description
<b>Description</b>	Displays the terminal description.
<b>Phone Type</b>	Displays the telephone type.
<b>Interface / Location</b>	For ISDN, system and analogue terminals, displays the interface at which you're connected to the system. The configured location is displayed for IP terminals.
<b>Internal Numbers</b>	Displays the configured internal number.

## Chapter 12 Call Routing

The functions for external calls and automatic route selections for external calls are defined in call routing.

### 12.1 Outgoing Services

In the **Call Routing->Outgoing Services** menu, you can configure the performance features **Direct Call**, **Call Forwarding**, **Dial Control** and **Priority Numbers**.

#### 12.1.1 Direct Call

In the **Call Routing->Outgoing Services->Direct Call** menu you configure numbers that are dialled directly without the subscriber needing to dial a number themselves on the phone.

You wish to configure a telephone for which a call to a specific number is set up even without entry of the number (e.g. emergency telephone). You are not at home. However, there is someone at home who needs to be able to reach you quickly and easily by telephone, if required (e.g. children or grandparents). If you have set up the "Direct Call" function for one or more telephones, the receiver of the corresponding telephone only needs to be lifted. After a period without further entries set in configuration, the system automatically dials the configured direct call number.

If you do not dial within the specified period from picking up the receiver, automatic dialling is initiated.

The time for Direct Call is set under **System Management->Global Settings->Timer->Direct Call**.



#### Note

In the system, up to 10 direct call destinations with names and telephone numbers can be set up by the administrator. These destinations should then only be assigned to the terminals by the user via the user configuration interface. In the configuration, system direct call, or a direct call specifically configured for the terminal, can then be set by the user.



### 12.1.1.1 Edit or New

Choose the  icon to edit existing entries. Select the **New** button to create new entries.

The **Call Routing->Outgoing Services->Direct Call->New** menu consists of the following fields:

#### Fields in the Basic Settings menu

Field	Description
<b>Description</b>	Enter a description for the entry.
<b>Direct Call Number</b>	Enter the number to be automatically dialled if no number is to be dialled for a certain time after the receiver has been picked up.

### 12.1.2 Call Forwarding

In the **Call Routing->Outgoing Services->Call Forwarding** menu, you configure call forwarding of external calls for an internal subscriber.

You are temporarily away from your office, but don't want to miss a call. With call forwarding to another number, e.g. your mobile, you can receive your calls even when you are not at your desk. You can forward calls on your number to any call number. It can occur *Immediately*, *On no reply* or *On Busy*. Call forwarding *On no reply* and *On Busy* can exist concurrently. If you are not near your telephone, for example, the call is forwarded to another number (e.g. your mobile phone) after a short period. If you are making a call at your desk, other caller may receive the busy signal. You can forward these callers e.g. to a colleague or the secretary by using call forwarding on busy.

Every internal subscriber to the system can forward her calls to another number. Calls can be forwarded to internal subscriber numbers, internal team numbers or external numbers. When the number to which calls shall be forwarded is entered, the system automatically checks whether it's an internal or external number.

In a team, call forwarding can be set up for one subscriber in the team. This call continues to be signalled to the other team subscribers. Call forwarding to an internal or external subscriber is performed in the system.

Call forwarding to an internal number is performed in the system. If an internal call to an external number is to be forwarded, forwarding also occurs in the system. Here, the connection is on the bundle cleared for the subscriber doing the setup. If call forwarding occurs via an ISDN connection, one B channels remains in use; in case of forwarding from external to

external, it's both B channels. Two possibilities exist for call forwarding of an external call to an external number:

- Call forwarding in the exchange: Call forwarding is conducted at the exchange if only one subscriber is entered in the call allocation for an external call. For call forwarding in the exchange, the performance features Call Deflection (point-to-multipoint connection) or Partial Rerouting (point-to-point connection) must be enabled with the network operator for the relevant ISDN connections.
- Call forwarding in the system: Call forwarding occurs in the system if the required performance features for call forwarding at the exchange are not available for the relevant ISDN connections. If several telephones (e. g. a team), some of which have set up call forwarding, receive an external call, the corresponding call forwarding is performed in the system. Here, the external connection is set up over a bundle's B channel, cleared for the subscriber initiating the setup. This B-channel remains assigned for the duration of active call forwarding.



#### Note

If the system is connected to the external ISDN (if supported by you device), for external-to-external connections, the system systematically attempts to initiate call forwarding via the exchange. For teams, there can be manual definition of whether call forwarding shall occur via the exchange or the system. If the system possesses no ISDN connections, or if Call Deflection (point-to-multipoint connection) or Partial Rerouting (point-to-point connection) has not been ordered from the network operator, call forwarding occurs solely in the system.

### 12.1.2.1 Edit or New

Choose the  icon to edit existing entries. Select the **New** button to create new entries.

The **Call Routing->Outgoing Services->Call Forwarding->New** menu consists of the following fields:

#### Fields in the Basic Settings menu

Field	Description
<b>Internal Number</b>	Select the internal number to which the incoming calls shall be forwarded.
<b>Type of Call Forwarding</b>	Select when incoming calls shall be forwarded to the specified internal number.

Field	Description
	Possible values: <ul style="list-style-type: none"> <li>• <i>Immediately</i></li> <li>• <i>On Busy</i></li> <li>• <i>On no reply</i> (default value)</li> <li>• <i>On busy / On no reply</i></li> </ul>
<b>Target Number "On no reply"</b>	Enter the number to which incoming calls shall be forwarded after time.
<b>Target Number "On busy"</b>	Enter the number to which incoming calls shall be forwarded on busy.
<b>Target Number "Immediate"</b>	Enter the number to which incoming calls shall be forwarded immediately.

### 12.1.3 Dial Control

In the **Call Routing->Outgoing Services->Dial Control** menu, you block specific numbers/partial numbers, or release these .

You wish to prevent dialling of specific numbers in the system, e. g. the numbers of expensive value-added services. Enter these numbers or partial numbers into the dial ranges list of blocked numbers. All subscribers subject to dial ranges cannot dial these numbers. However, if you should need specific numbers from a blocked sector, you can clear these via the dial ranges list of cleared numbers.

You can block specific numbers or prefixes with the blocked numbers list. You can clear the blocked numbers or prefixes with the cleared numbers list. If a number entered as a cleared number is longer than one entered as a blocked number, this number can be dialled. When you dial a number, dialling after the blocked digit is terminated and you hear the busy tone. You can assign each user individually to the dial ranges in the user settings.

Example: Blocked number *01*, all external numbers that begin with *01* are blocked. Cleared number *012345*, dialling can proceed. All external numbers that begin with *012345* can be dialled. If two identical numbers (same number sequence and same number of digits, e. g. *01234* and *01234*) are entered in the list of cleared numbers as well as the list of blocked numbers, dialling of the number is prevented.



### Note

Subscribers who enjoy full or partial dialling access (no outside line access) are authorised for dialling of cleared numbers via the list of cleared numbers.

Please ensure that the area code is entered in the configuration, otherwise, the block can be circumvented in the local network by prefixing the area code.

#### 12.1.3.1 Edit or New

Choose the  icon to edit existing entries. Select the **New** button to create new entries.

The **Call Routing->Outgoing Services->Dial Control->New** menu consists of the following fields:

##### Fields in the **Basic Settings** menu.

Field	Description
<b>Inhibited number</b>	Enter the number that cannot be dialled.
<b>Enabled number</b>	Enter the number for which dialling is explicitly permitted.

#### 12.1.4 Priority Numbers

In the **Call Routing->Outgoing Services->Priority Numbers** menu you configure numbers with particular special functions, e. g. emergency functions.

In your system configuration, you can enter numbers that must be accessible in an emergency. If you now dial one of these priority numbers, it is detected by the system and an ISDN B channel is automatically cleared. If the external ISDN B channels are already in use, one of the ISDN B channels is freed up and the calling subscribers hear the busy tone. An ongoing priority call is not interrupted.

##### 12.1.4.1 Edit or New

Choose the  icon to edit existing entries. Select the **New** button to create new entries.

The **Call Routing->Outgoing Services->Priority Numbers->New** menu consists of the following fields:

##### Fields in the **Basic Settings** menu.

Field	Description
<b>Description</b>	Enter a description for the entry.
<b>Priority Number</b>	Enter the number which can even be dialled if all B channels are occupied. In this case, an external B channel is released for this connection and reassigned for the priority call. An ongoing priority call is not interrupted.

## 12.2 Automatic Route Selection

In the **Call Routing->Automatic Route Selection** menu, you can set up routes for external calls in addition to configured line occupancy. Here, bundles released for users can be selectively assigned to ongoing calls according to the dialled number, or new providers entered along with their network access prefixes. You then specifically define the routing for individually created zones for every weekday.

### 12.2.1 General

In the **Call Routing->Automatic Route Selection->General** menu, you enable the ARS - Automatic Route Selection - function and select the desired route level.

The menu **Call Routing->Automatic Route Selection->General** consists of the following fields:

**Fields in the Basic Settings menu.**

Field	Description
<b>ARS</b>	<p>Select whether to enable the ARS performance feature (Automatic Route Selection).</p> <p>The function is activated by selecting <i>Enabled</i>.</p> <p>The function is disabled by default.</p>
<b>Routing Stage</b>	<p>Select whether additional routes shall be used if an entered provider or bundle cannot be accessed.</p> <p>Possible values:</p> <ul style="list-style-type: none"> <li>• <i>1 (No Fallback)</i>: If the entered provider or selected bundle is (<b>Call Routing-&gt;Automatic Route Selection-&gt;Zones &amp; Routing-&gt; Edit/Add -&gt; Mo-Su -&gt; Routing Stage 1</b>) not available, connection setup is terminated.</li> </ul>

Field	Description
	<ul style="list-style-type: none"> <li>• 2: If the entered provider or selected bundle (<b>Call Routing-&gt;Automatic Route Selection-&gt;Zones &amp;Routing-&gt;Edit/Add -&gt; Mo-Su -&gt;Routing Stage 1</b>) is not available, there is an attempt to initiate the connection over the additional entered routing variant (<b>Call Routing-&gt;Automatic Route Selection-&gt;Zones &amp;Routing-&gt; Edit/Add -&gt; Mo-Su -&gt;Routing Stage 2</b>).</li> <li>• 3 (default value): If neither of the two entered providers or bundles (<b>Call Routing-&gt;Automatic Route Selection-&gt;Zones &amp;Routing-&gt; Edit/Add -&gt; Mo-Su -&gt;Routing Stage 1</b> and <b>Routing Stage 2</b>) is available, dialling occurs via the provider entered as the default for the user (<b>Numbering-&gt;Class of Service-&gt;Add-&gt;Basic Settings-&gt;Trunk Line Selection with Line Access Number</b>).</li> </ul>

## 12.2.2 Interfaces / Provider

In the **Call Routing->Automatic Route Selection->Interfaces / Provider** menu, enter the routes or providers along with their network access profiles.

### 12.2.2.1 Edit or New

Choose the  icon to edit existing entries. Select the **New** button to create new entries.

The **Call Routing->Automatic Route Selection->Interfaces / Provider->New** menu consists of the following fields:

#### Fields in the **Basic Settings** menu.

Field	Description
<b>Description</b>	Enter a description for the entry.
<b>Routing Mode</b>	<p>Select how dialling shall be externally routed.</p> <p>Possible values:</p> <ul style="list-style-type: none"> <li>• <i>Default</i> (default value): The default procedure provides that when dialling externally, the prefix entered under <b>Call-prefix</b> is placed first.</li> <li>• <i>Route</i>: External dialling is set up via the bundle selected in <b>Route</b>.</li> </ul>

Field	Description
<b>Call-prefix</b>	Enter the number to be placed as a prefix when making an external call, e.g. to set up a connection via a call-by-call provider.
<b>Route</b>	Only if <b>Routing Mode</b> = <i>Route</i> Select a bundle via which the external call shall proceed.

### 12.2.3 Zones & Routing

In the menu **Call Routing**->**Automatic Route Selection**->**Zones & Routing** you define the zones via which dialling shall proceed using specific routes or providers.

Configuration of the routing tables for the defined zones occurs individually for each week-day. For 2 routing tables, routing level 1 and routing level 2 can be created as fallback.

Choose the  icon to edit existing entries. Select the **New** button to create new entries.

#### 12.2.3.1 Trunk Numbers

In the **Trunk Numbers** area, enter the number or partial number of the zones for which you wish to configure the routing tables.

**Fields in the Basic Settings menu.**

Field	Description
<b>Description</b>	Enter a description for the entry.
<b>Zones</b>	Configure the desired external zones which should be dialled via the desired entered provider/routes.  Possible values: <ul style="list-style-type: none"> <li>• <i>Number/Partial Number</i>: Enter the number or part of a number identifying a zone.</li> <li>• <i>Name</i>: Enter a name for this zone.</li> </ul>

#### 12.2.3.2 Mon - Sun

In the **Mon - Sun** area, select the desired times for each routing level, and the desired route or provider via which outgoing calls shall be routed from the entered time.

**Fields in the <Weekday> menu**

Field	Description
<b>Routing Stage 1</b>	Configure the switching times for routing level 1. For this, first select the <b>Start Time</b> from which routing shall occur over a specific interface or a specific network provider, and select the latter under <b>Interface / Provider</b> .
<b>Routing Stage 2</b>	Configure the switching times for routing level 2. For this, first select the <b>Start Time</b> from which routing shall occur over a specific interface or a specific network provider, and select the latter under <b>Interface / Provider</b> .



## Chapter 13 Applications

Internal telephone performance features of the system are set up under **Applications**.

### 13.1 Calendar

In the **Applications->Calendar** menu, you can decide whether to make new entries or modifications in the calendar.

Every company has fixed business hours. You can enter these in the system's internal calendar. For example, all calls outside of business hours can be signalled to a exchange or an answering machine. During this period, your employees can perform other tasks, without being interrupted by telephone calls. The individual call options of a team are automatically switched through the calendars.

You wish to modify the external calling authorisations after business hours for specific subscribers. In the system configuration, you can set individually for each user whether the authorisation for external calls is automatically switched. The switch occurs according to the data in the assigned calendar.

You can set up five types of calendars in the system. The "Authorisation Class" and "Night Operation" calendars are intended for central switching and can only be set up once. The "Team Signalling", "Intercom Signalling" and "Redirect to internal/external number" calendars can be set up repeatedly. Several different switching times can be selected for each weekday.

In the configuration, a calendar can be assigned to all performance features for which several options can be defined (e.g. teams) Switching between the individual call options then occurs at the switching times of the assigned calendar.

#### 13.1.1 Calendar

In the menu **Applications->Calendar->Calendar** you can view, modify or copy a previously set calendar as well as create new calendars.

Choose the  icon to edit existing entries. Select the **New** button to create new entries.

##### 13.1.1.1 General

In the **General** area you define the name of the calendar to be created.

The menu **Applications->Calendar->Calendar->General** consists of the following fields:

#### Fields in the menu **Basic Settings**

Field	Description
<b>Description</b>	Enter a description for the calendar.
<b>Application</b>	<p>Select the application for which the calendar shall be used.</p> <p>Please note that this field cannot be edited with pre-existing entries. If another application is to be configured, you must create another entry and delete the existing one.</p> <p>Possible values:</p> <ul style="list-style-type: none"> <li>• <i>Team Signalling</i> (default value): Here, several calendars can be set up.</li> <li>• <i>Doorline Signalling</i>: Here, several calendars can be set up.</li> <li>• <i>Night Mode</i>: Here, only one calendar can be set up.</li> <li>• <i>Class of Service</i>: Here, only one calendar can be set up.</li> <li>• <i>Rerouting for internal/external Number</i>: Here, several calendars can be set up.</li> <li>• <i>Voice Mail System</i>: Here, several calendars can be set up.</li> <li>• <i>Alarm Input</i>: Here, several calendars can be set up.</li> </ul>

### 13.1.1.2 Mon - Sun / Exception

#### Mon - Sun

In the **Mon - Sun** area you set up the switching days and times for this calendar.

The **Applications->Calendar->Calendar->Mon - Sun** menu consists of the following fields:

#### Fields in the <Weekday> menu

Field	Description
<b>Switching Points</b>	<p>Enter the desired switching times.</p> <p>For this, under <b>Time</b>, for each weekday select the desired</p>

Field	Description
	<p>switching points to which switching shall occur from any divergent active switching option in the desired switching options selected under <b>Action</b>.</p> <p>Depending on the application, the following switching options are available:</p> <ul style="list-style-type: none"> <li>• <i>Team Signalling</i>: Call option 1 to call option 4</li> <li>• <i>Doorcom Signalling</i>: Door Intercom call option 1 and door intercom call option 2</li> <li>• <i>Night Mode</i>: Night operation on and night operation off</li> <li>• <i>Class of Service</i>: Authorisation class by default and authorisation class optional</li> <li>• <i>Rerouting for internal/external Number</i>: Redirect option 1 to redirect option 4</li> <li>• <i>Voice Mail System</i>: <b>Action In the Office and Out of Office</b></li> <li>• <i>Alarm Input</i>: Night operation on and night operation off</li> </ul>
<b>Use settings from</b>	<p>Only if settings have already been performed for a weekday.</p> <p>Select from which weekday the settings should be imported.</p> <p>If you require specific settings for this day, select the option <i>Individual</i>.</p>

### Exception

In the **Exception** area, select whether holidays shall be taken into account and, if so, how.

The menu **Applications->Calendar->Calendar->Exception** consists of the following fields:

#### Fields in the Settings holidays menu

Field	Description
<b>Consider public holidays</b>	<p>Select whether appointments entered in the <b>Applications-&gt;Calendar-&gt;Public Holiday</b> menu shall also be considered in this calendar.</p> <p>The function is activated by selecting <i>Enabled</i>.</p>

Field	Description
	The function is disabled by default.
<b>Use settings from</b>	<p>Only if <b>Consider public holidays</b> is enabled.</p> <p>Select from which weekday the settings for holidays should be imported. Configure weekdays in menu <b>Applications-&gt;Calendar-&gt;Calendar-&gt; Mon - Sun</b></p> <p>If you require specific settings for holidays, select the option <i>Individual</i>.</p>
<b>Switching Points</b>	<p>Only for <b>Use settings from</b> = <i>Individual</i></p> <p>Enter the desired switching times.</p> <p>For this, under <b>Time</b>, select the desired switching points to which switching shall occur from any divergent active switching option in the desired switching options selected under <b>Action</b>.</p> <p>Depending on the application, the following switching options are available:</p> <ul style="list-style-type: none"> <li>• <i>Team Signalling</i>: Call option 1 to call option 4</li> <li>• <i>Doorcom Signalling</i>: Door Intercom call option 1 and door intercom call option 2</li> <li>• <i>Night Mode</i>: Night operation on and night operation off</li> <li>• <i>Class of Service</i>: Authorisation class by default and authorisation class optional</li> <li>• <i>Rerouting for internal/external Number</i>: Redirect option 1 to redirect option 4</li> <li>• <i>Voice Mail System</i>: <b>Action In the Office</b> and <b>Out of Office</b></li> <li>• <i>Alarm Input</i>: Night operation on and night operation off</li> </ul>

### 13.1.2 Public Holiday

In the **Applications->Calendar->Public Holiday** menu, you can enter holidays or any special days for which divergent settings should be made via the calendar. The holiday entries are sorted by date!

### 13.1.2.1 Edit or New

Choose the  icon to edit existing entries. Select the **New** button to create new entries.

The menu **Applications->Calendar->Public Holiday->New** consists of the following fields:

#### Fields in the Basic Settings menu.

Field	Description
<b>Description</b>	Enter a description for a holiday.
<b>Date (DD - MM)</b>	Enter the date with day and month in two-digit form. Incorrect entries, e. g. 31.02 are accepted and saved but not executed by the system.

## 13.2 Rerouting

In the **Applications->Rerouting** menu, you configure how incoming calls should be handled by default in the system.

### 13.2.1 Rerouting Functions

In the **Applications->Rerouting->Rerouting Functions** menu you can set up various redirect options for *Immediately*, *On Busy*, *On No Reply* or *On Busy and On No Reply*. You then assign these redirect options to the external connections in the **Numbering->Call Distribution->Incoming Distribution** menu.

#### 13.2.1.1 Edit or New

Choose the  icon to edit existing entries. Select the **New** button to create new redirect options.

The **Applications->Rerouting->Rerouting Functions->New** menu consists of the following fields:

#### Fields in the Basic Settings menu.

Field	Description
<b>Description</b>	Enter a description for the redirect function.

Field	Description
<b>Type of Rerouting Function</b>	<p>Select the desired exchange function.</p> <p>Possible values:</p> <ul style="list-style-type: none"> <li>• <i>Immediately</i> (default value)</li> <li>• <i>On Busy</i></li> <li>• <i>On No Reply</i></li> <li>• <i>On Busy and On No Reply</i></li> </ul>

#### Fields in the **On Busy Settings** menu.

Field	Description
<b>Size of Queue</b>	<p>Only for <b>Type of Rerouting Function</b> = <i>On Busy</i> or <i>On Busy and On No Reply</i></p> <p>In this field, you can configure the maximum number of subscribers on hold. The queue may include up to 10 subscribers. Additional callers get a "busy" tone.</p> <p>Possible values are 0 (no queue) to 10. The default value is 0.</p>
<b>Take Waiting Calls with</b>	<p>Only for <b>Type of Rerouting Function</b> = <i>On Busy</i> or <i>On Busy and On No Reply</i></p> <p>Define what callers on hold shall hear (internal or configured music-on-hold, announcement).</p> <p>Possible values:</p> <ul style="list-style-type: none"> <li>• <i>MoH Wave 1 to MoH Wave 8</i></li> <li>• <i>MoH internal 1</i> (default value)</li> <li>• <i>MOH internal 2</i></li> <li>• <i>Off</i></li> </ul>
<b>Max waiting time in the queue</b>	<p>Only for <b>Type of Rerouting Function</b> = <i>On Busy</i> or <i>On Busy and On No Reply</i></p> <p>Define maximum time a caller can remain on hold. After expiration of this time, the caller shall be transferred to the defined redirect destination. Leave <i>Endless</i> for an unlimited queue (corresponds to value 0). Disable <i>Endless</i>, to enter the desired value.</p>

**Fields in the On No Reply Settings menu.**

Field	Description
<b>Time for Rerouting on No Reply</b>	<p>Define maximum time a caller can remain on hold if she cannot reach the destination number. After expiration of this time, the caller shall be transferred to the defined redirect destination.</p> <p>The default value is <i>30</i> seconds.</p>

**Fields in the Further Settings menu.**

Field	Description
<b>Announcement</b>	<p>Select whether the incoming call shall be redirected to an announcement.</p> <p>Possible values:</p> <ul style="list-style-type: none"> <li>• <i>Off</i> (default value): The incoming call is not redirected to an announcement.</li> <li>• <i>MoH Wave 1 to MoH Wave 8</i></li> </ul>
<b>Target Number</b>	<p>Select the internal number to which the incoming call shall be redirected.</p> <p>Possible values:</p> <ul style="list-style-type: none"> <li>• <i>No Number (Disconnect)</i>: The call is terminated, the connection ended.</li> <li>• <i>&lt;Extension number&gt;</i>: If a destination number is entered, the call is forwarded.</li> </ul>
<b>Transfer with</b>	<p>The caller hears the defined announcement or music while her call is being transferred.</p> <p>Possible values:</p> <ul style="list-style-type: none"> <li>• <i>Ring tone</i></li> <li>• <i>MoH Wave 1 to MoH Wave 8</i></li> <li>• <i>MOH internal 1</i></li> <li>• <i>MOH internal 2</i></li> <li>• <i>&lt;Wave file&gt;</i></li> </ul>

**Announcement before query**

You have set up a general information call number which customers with various problems or requests ring up. Naturally, no single employee or team can provide information in every subject areas. So the caller would need to be transferred to the individual departments. If you knew beforehand which requests (subject area) a caller had, you could immediately transfer him to the competent department. Thus, your callers don't have to be initially accepted and transferred by an exchange. Every caller decides for him/herself with which employee he/she wishes to be connected.

With the performance feature **Auto Attendant with DISA** calls are automatically accepted by the system. The caller then hears an announcement with information about which entries are possible during or after the announcement. Once the entry is made, the announcement ends and the caller is transferred to an internal subscriber or team. If the caller provides a false or no entry, he/she is transferred to the defined redirect destination (internal subscriber or team). While being transferred, the caller hears a ring tone or the system's music-on-hold.



#### Note

DISA - Direct Inward System Access Once a call is received by the system, the caller is automatically transferred after a code number is entered. This code is assigned to an internal number in the system. Entry of a number or code must occur during the announcement. Once the announcement (Wave file) ends, no more entries are accepted. There follows redirect to a defined redirect destination. The performance feature **Auto Attendant with DISA** is an integral part of the system and can accept up to 28 calls simultaneously.

#### Fields in the Announcement/Auto Attendant Settings menu.

Field	Description
<b>Call Switching</b>	<p>Select how incoming calls are to be transferred.</p> <p>Possible values:</p> <ul style="list-style-type: none"> <li>• <i>Announcement without DISA</i> (default value): The configured announcement is played. There follows either transfer to the configured internal number, or the connection is interrupted and the caller hears the busy tone.</li> <li>• <i>DISA, dial internal numbers</i>: The caller is prompted to enter an internal number. The call is forwarded to the number.</li> <li>• <i>DISA, dial code numbers</i>: The caller is prompted to enter a code number from 0 to 9. The desired internal numbers are assigned to the codes. The caller is then transferred</li> </ul>



Field	Description
	to the configured internal number.
<b>Number of playbacks</b>	Select how many times the announcement shall be continuously repeated. At conclusion, the caller hears the busy tone.
<b>Auto Attendant with DISA</b>	Only if <b>Call Switching</b> = <i>DISA, dial code numbers</i>  For ever desired DISA code number, select the desired internal number to which the caller shall be transferred.

## 13.2.2 Rerouting Applications

In the **Applications->Rerouting->Rerouting Applications** menu, you can configure when which redirect option is to be enabled. You can switch the various options either via calendar or manually.

Choose the  icon to edit existing entries. Select the **New** button to create new redirect applications.

### 13.2.2.1 General

In the **General** area, you perform basic settings for a redirect application.

The **Applications->Rerouting->Rerouting Applications->New** menu consists of the following fields:

#### Fields in the **Basic Settings** menu.

Field	Description
<b>Description</b>	Enter a description for the redirect application.
<b>Type of Rerouting Application</b>	Select the destination to which an incoming call shall be redirected.  Possible values: <ul style="list-style-type: none"> <li>• <i>Trunk Number</i> (default value)</li> <li>• <i>Extension</i></li> <li>• <i>Global</i></li> </ul>
<b>Switch call signalling</b>	Select how to switch between options

Field	Description
	Possible values: <ul style="list-style-type: none"> <li>• <i>No calendar, only manually</i></li> <li>• <i>&lt;Calendar&gt;</i></li> </ul>

### 13.2.2.2 Variant 1 - 4

In the **Variant** area, you configure the redirect options. You can define up to 4 options.

The menu **Applications->Rerouting->Rerouting Applications->Variant** consists of the following fields:

#### Fields in the Basic Settings menu.

Field	Description
<b>Assignment</b>	Choose the redirect function to which you wish to assign the selected option.

## 13.3 Voice Applications

In the **Applications->Voice Applications** menu, you configure you system's wave files.

A professional greeting, especially on the telephone, constitutes a company's visiting card. Voice applications make this possible for every business. Indeed, while being transferred, the caller receives information that's individually tailored, e. g. according to department, or is simply entertained with pleasant music-on-hold.

You wish to employ special music as music-on-hold, or specific announcements for your clients. You can load your self-produced Wave files to the system.

User-specific voice and music files can be saved in the system. Storage space for 2 MoH melodies is available in the system basic settings. The available storage space can be extended with an SD card (if supported by you device). The length of the language and music files that can be saved is based upon the SD card used. Voice and music data is saved in Wave format.

The following voice applications can be defined in the system:

- Announcement before query
- Announcement without query/Infobox
- Wake-up call

- Music on hold

You can find additional information on function, configuration and operation in the description of the individual performance features.

## Basic settings of voice applications

The voice applications can be assigned to individual performance features in two different ways.

Every user employing a voice application with this connection always hears the corresponding voice announcement or music from the start. A newly-arrived user hears the voice announcement or music from the start. The number of users who can simultaneously use such a voice application is limited to 28.

Please note that externally played music or voice application music are free of third-party copyrights (GEMA free). Files in other formats must be converted into the company-specific Wave format before being saved in the system.





### Note



Please note that Wave files must be available in the following format:

- Bit rate: 128 kbps
- Sampling size: 16 bits
- Channels 1 (mono)
- Sampling rate: 8 kHz
- Audio format: PCM

## 13.3.1 Wave Files

In the **Applications->Voice Applications->Wave Files** menu, you can configure your announcement/melody files and volume. You also have the option to play back voicemail messages or download these to your PC. To save a message, click on the  icon. The download dialog then opens. To listen to a message, click on the  icon.

### 13.3.1.1 Edit

Choose the  icon to edit existing entries. Select  to change the entry.

*MoH internal 1* and *MoH internal 2* are files specified in the system and can thus not be deleted.

The **Applications->Voice Applications->Wave Files->Edit** menu consists of the following fields:

#### Fields in the **Basic Settings** menu.

Field	Description
<b>Description</b>	Enter a description for the Wave file.
<b>Select file</b>	Click <b>Browse...</b> and select the Wave file to be loaded into the system through the Explorer window.
<b>Volume</b>	<p>Select the volume at which the Wave file shall be played by default. Select <i>0</i> to play the file at a predefined default volume. You can gradually diminish the volume using the negative values, and increase it with the positive ones.</p> <p>Possible values:</p> <ul style="list-style-type: none"> <li>• -5</li> <li>• -4</li> <li>• -3</li> <li>• -2</li> <li>• -1</li> <li>• 0 (default value)</li> <li>• +1</li> <li>• +2</li> <li>• +3</li> </ul>

## 13.4 System Phonebook

In the **Applications->System Phonebook** menu, you can enter and administer numbers in the system phone book.

The employees in your company must phone many customers. This is where the system phone book comes in. You need not enter the customer's number but can extract the name via the system telephone display, and dial. Customer names and telephone numbers can be centrally administered by an employee. If a customer whose number has been entered in the phone book calls, his/her name appears in the system telephone display. The system features an integrated phone book in which you can save phone book entries of up to 24-digits (numbers) and up to 20-character names (text).

When creating a telephone book entry, a **Speed Dial Number** code is assigned to each entry. Authorised telephones can initiate speed dial from the phone book via these speed dial numbers.

## System telephones

System telephones can dial from the system phone book via a special menu. To search for a telephone entry, enter the first letters (max. 8) of the desired name and confirm the entry. The system always provides 8 phone book entries, which you can view successively. Select the desired entry and confirm with **OK**. You must now begin to dial within 5 seconds. The system telephone redialling list displays the name of the dialled subscriber instead of her number. If a system telephone receives a call whose number and name are saved in the system phone book, the caller's name is indicated in the system telephone display.



### Note

The user's other numbers (**Mobile Number** and **Home Number**) are only displayed in the system telephone phone book menu. They are not displayed in the **System Phonebook** menu of the user interface. Entries in the system telephone phone book menu with the (M) mark refer to an entered **Mobile Number** of a user; those with the (H) mark to **Home Number**.



### Note

Your PABX system supports LDAP (Lightweight Directory Access Protocol) for providing the entries of the system phonebook to other devices. Name, Number as well as mobile and private numbers can be transferred this way.

## 13.4.1 Entries

In the **Applications->System Phonebook->Entries** menu, all configured telephone book entries are displayed with the corresponding speeddial index. The entries in the **Description** column are sorted alphabetically. Click the column title of any column to sort entries in ascending or descending order.

### 13.4.1.1 Edit or New

Choose the  icon to edit existing entries. Select the **New** button to create new entries.

The menu **Applications->System Phonebook->Entries->New** consists of the following

fields:

#### Fields in the **Phonebook Entry** menu.

Field	Description
<b>Description</b>	Enter a description for the entry. Subsequent sorting in the phone book follows the initial letters of the entry.
<b>Phone Number</b>	Enter the telephone number (internal or external).
<b>Speed Dial Number</b>	Enter a speed dial code. If a speed dial code is entered, counting is automatic; i.e. speed dial is automatically assigned.  Numbers from 0 to 999 are possible.
<b>Call Through</b>	Select whether the telephone number for the <b>Call Through</b> function has been activated. If a telephone number is approved for this, and the caller uses this number for the <b>Call Through</b> functions, the caller's authorisation to use the function is checked against the phonebook record.  The function is activated by selecting <i>Enabled</i> .  The function is disabled by default.

### 13.4.2 Import / Export

You can import and export phone book data in the **Applications->System Phonebook->Import / Export** menu. You can import data exported from Microsoft Outlook, for example. The phone book data stored in your device is exported to a text file.

The **Applications->System Phonebook->Import / Export** menu consists of the following fields:

#### Fields in the **Basic Settings** menu.

Field	Description
<b>Action</b>	Select the desired action.  Possible values: <ul style="list-style-type: none"> <li><i>Export</i> (default value): You can export the names saved in <b>Applications-&gt;System Phonebook-&gt;Entries</b> into a text file (specifying phone number, speed dial, call through).</li> </ul>

Field	Description
	<ul style="list-style-type: none"> <li>• <i>Import</i>: You can import a text file in the following format: The file imported must consist of individual rows in the following format: name, phone number, speed dial, call through (1 = enabled, 2 = disabled).</li> </ul> <p>Example:</p> <p>Name,Phone Number,Speeddial Number,Call Through</p> <p>Hans,123456,1,1</p> <p>Klaus,234567,2,2</p> <p>Max,345678,3,1</p>
<b>Separator</b>	<p>Only for <b>Action</b> = <i>Import</i> and Default File Format not enabled</p> <p>Enter the separator type in the import file.</p> <p>Possible values:</p> <ul style="list-style-type: none"> <li>• <i>Comma</i> (default value)</li> <li>• <i>Semicolon</i></li> <li>• <i>Space</i></li> <li>• <i>Tabulator</i></li> </ul>
<b>Select file</b>	<p>Only for <b>Action</b> = <i>Import</i> select the file to be imported.</p>

You also have the option to import a CSV file.

If the data record consists of more than one column, you have the option to generate two address book entries from the data record for the import (e.g. one for business and one private entry.) To do this, specify the data to be used as the name and phone number in an additional import step. If you want to generate only one phonebook entry, select the blank option in all selection fields for the second record **Phonebook Import**.

#### Fields in the Phonebook Import menu.

Field	Description
<b>Phone Number</b>	Select which data is to be used from a data record as the phonenumber.
<b>Name</b>	Select which columns are to be used from a data record as the

Field	Description
	name. You have the option to use two elements here (e.g. fore-name and surname). The middle input field can be used to place a character string between the two elements here. The default separator used is a comma.

Speed dial is automatically assigned. By default, call through is disabled.

### 13.4.3 General

In the menu **Applications->System Phonebook->General** you define the user name and password for system phone book administration. In the phone book area, the administrator can view and modify the phone book, as well as import and export data.

The **Applications->System Phonebook->General** menu consists of the following fields:

#### Fields in the Basic Settings menu.

Field	Description
<b>Web Access Username</b>	Enter a user name for the system telephone book administrator.
<b>Web Access Password</b>	Enter a password for the system telephone book administrator.
<b>Delete Phonebook</b>	<p>If you wish to remove the existing system phone book with all of its entries, enable the option <b>Delete</b>. You will then be asked for confirmation <b>Do you really want to delete all entries of the phonebook?</b>. Confirm your entry by clicking <b>OK</b>.</p> <p>The option <b>Delete</b> is disabled by default.</p>

## 13.5 Call Data Records

In the **Applications->Call Data Records** menu, you configure the recording of incoming and outgoing calls.

The capture of call data records provides an overview of the telephone usage in your company.

All external calls can be saved in the device in the form of call data records. These data records contain important information about the individual calls.

You must enable recording of connection data in the **Numbering->User Settings->Class**



of **Services->Applications** menu. The function is not activated in the ex works state.

### 13.5.1 Outgoing

The **Applications->Call Data Records->Outgoing** menu contains information that permits the monitoring of outgoing activities.

The **Applications->Call Data Records->Outgoing** menu consists of the following fields:

#### Fields in the Outgoing menu.

Field	Description
<b>Date</b>	Displays the connection date.
<b>Time</b>	Displays the time at call start.
<b>Duration</b>	Displays the duration of the connection.
<b>User</b>	Displays the user who called.
<b>Int. No.</b>	Displays the user's internal number.
<b>Called Number</b>	Displays the dialled number.
<b>Project Code</b>	Displays the call project number, if any.
<b>Interface</b>	Displays the interface over which the external connection was routed.
<b>Costs</b>	Displays the connection charge, but only if the provider transmits the corresponding data.

### 13.5.2 Incoming

The **Applications->Call Data Records->Incoming** menu contains information that permits the monitoring of incoming activities.

The **Applications->Call Data Records->Incoming** menu consists of the following fields:

#### Fields in the Incoming menu.

Field	Description
<b>Date</b>	Displays the connection date.
<b>Time</b>	Displays the time at call start.
<b>Duration</b>	Displays the duration of the connection.
<b>User</b>	Displays the user who was called.
<b>Int. No.</b>	Displays the user's internal number.
<b>External Number</b>	Displays the caller's number.
<b>Project Code</b>	Displays the call project number, if any.
<b>Interface</b>	Displays the interface over which the connection from outside was routed.

### 13.5.3 General

In the **Applications->Call Data Records->General** menu, you can define how connection data are saved in the system.

The **Applications->Call Data Records->General** menu consists of the following fields:

#### Fields in the Basic Settings menu.

Field	Description
<b>Web Access Username</b>	Enter a user name for the call data administrator.
<b>Web Access Password</b>	Enter a password for the call data administrator.
<b>Save outgoing calls</b>	Select which outgoing connections should be saved.  Possible values: <ul style="list-style-type: none"> <li>• <i>None</i> (default value)</li> <li>• <i>All</i></li> <li>• <i>With Project Code only</i></li> </ul>
<b>Save incoming calls</b>	Select which incoming connections should be saved.

Field	Description
	<p>Possible values:</p> <ul style="list-style-type: none"> <li>• <i>None</i> (default value)</li> <li>• <i>All</i></li> <li>• <i>With Project Code only</i></li> </ul>
<b>Privacy Number Truncation</b>	<p>Select whether to save the number in abbreviated form.</p> <p>If, for data privacy reasons, the number is to be only partially displayed, you can select the number of positions not to be displayed here. For <b>Outgoing Calls</b> and for <b>Incoming Calls</b> you can separately enter the number of hidden digits. The hiding of digits occurs from right to left.</p> <p>Possible values:</p> <ul style="list-style-type: none"> <li>• <i>No</i> (default value)</li> <li>• <i>All</i></li> <li>• <i>1 to 9</i></li> </ul>
<b>Transfer call data records via Serial 2</b>	<p>For modular PABX systems only</p> <p>Select whether to export call data records over the serial interface (Serial 2) after each call which enables you to connect an external charge metering software solution (hotel application).</p> <p>The function is activated by selecting <i>Enabled</i>.</p> <p>The function is disabled by default.</p>

#### Fields in the Actions menu.

Field	Description
<b>Export call data records</b>	If you wish to save the current connection data record in an external file, click <b>Export</b> and save the file under the desired storage location and file name.
<b>Delete call data records</b>	If you wish to delete the current connection data record from the system storage, click <b>Delete</b> .

## 13.6 Call List

The menu **Applications->Call List** lists details of incoming and outgoing calls. Which kind of calls and how many of them are included can be specified in the submenu **General**.

### 13.6.1 Incoming

The **Applications->Call List->Incoming** menu contains information that permits the monitoring of incoming activities.

The **Applications->Call List->Incoming** menu consists of the following fields:

#### Fields in the Incoming menu

Field	Description
<b>Date</b>	Displays the connection date.
<b>Time</b>	Displays the time at call start.
<b>Type</b>	Displays the type of the connection.
<b>User</b>	Displays the user who was called.
<b>Int. No.</b>	Displays the user's internal number.
<b>Caller Number</b>	Displays the caller's number.
<b>Trunk Number</b>	Displays the port number.
<b>Interface</b>	Displays the interface over which the connection from outside was routed.
<b>Delete</b>	You can use the <b>Select all</b> and <b>Deselect all</b> buttons for all the devices displayed.

### 13.6.2 Outgoing

The **Applications->Call List->Outgoing** menu contains information that permits the monitoring of outgoing activities.

The **Applications->Call List->Outgoing** menu consists of the following fields:

#### Fields in the **Outgoing** menu

Field	Description
<b>Date</b>	Displays the connection date.
<b>Time</b>	Displays the time at call start.
<b>Type</b>	Displays the type of the connection.
<b>User</b>	Displays the user who was called.
<b>Int. No.</b>	Displays the user's internal number.
<b>Called Number</b>	Displays the caller's number.
<b>Trunk Number</b>	Displays the port number.
<b>Interface</b>	Displays the interface over which the connection from outside was routed.
<b>Delete</b>	You can use the <b>Select all</b> and <b>Deselect all</b> buttons for all the devices displayed.

### 13.6.3 General

In the **Applications->Call List->General** menu, you can define how the connection data is saved in the system.

The **Applications->Call List->General** menu consists of the following fields:

#### Fields in the **Basic Settings** menu

Field	Description
<b>Record calls</b>	<p>Select which kind of calls are to be included.</p> <p>Possible values:</p> <ul style="list-style-type: none"> <li>• <i>None</i></li> <li>• <i>Incoming only</i> (default value)</li> <li>• <i>All</i></li> </ul>

Field	Description
<b>Record connected calls</b>	Select if accepted calls are to be included, too. This can significantly increase the number of included calls and decrease the amount of time the list can cover until the maximum number of calls is reached and the first calls are deleted from the list.
<b>Max Call List entries for System Calls</b>	Specify the maximum amount of system calls that are included in the list. The maximum number is <i>1000</i> . System calls include, e.g., call transfers to extern, calls being accepted by an announcement, team calls that are not accepted by a single user.
<b>Max Call List entries per User</b>	Specify the maximum amount of user calls (calls initiated or accepted by a configured user) that are included in the list. The maximum number is <i>200</i> .

## 13.7 Mini Call Center

The mini call centre is an integrated call centre solution for up to 16 agents. It provides the ideal solution for small groups with high dynamic telecommunication volumes (e. g insides sales, support, order acceptance/processing, customer service). Here, a specific solution with its own administrator has been integrated. The mini call centre is characterised by:

- Flexible allocation of agents and lines
- Dynamic adaptation according to call volume
- Call allocation with off-time for the agent
- Statistical data for agents and lines.

### 13.7.1 Status

In the **Applications->Mini Call Center->Status** menu, you can view the current status of lines and logged-in agents in a block, along with the subscribers assigned to lines.

The menu **Applications->Mini Call Center->Status** consists of the following fields:

#### Values in the Status list

Field	Description
<b>View</b>	<b>View</b> allows you to select which call centre to display.
<b>Line</b>	Displays the mini call centre line.
<b>Agents assigned</b>	Displays the number of agents assigned to this line.

Field	Description
<b>Agents logged on</b>	Displays the number of agents logged-in on this line.
<b>Agents in Wrap-up</b>	Displays the number of agents in post-processing time.
<b>Active Calls</b>	Displays the number of active connections.
<b>Waiting Calls</b>	Displays the number of waiting incoming calls.
<b>Answered of Calls Today</b>	Displays the current number of accepted calls for this day.
<b>Lost Calls Today</b>	Displays the current number of missed calls for this day.

## 13.7.2 Lines

In the **Applications->Mini Call Center->Lines** menu, lines are assigned to external and internal numbers, and the name of the call centre to which the line belongs is displayed.

Choose the  icon to edit existing entries. Select the **New** button to create new entries.

### 13.7.2.1 General

In the **General** area, you perform basic settings for a line.

The menu **Applications->Mini Call Center->Lines->General** consists of the following fields:

#### Fields in the Basic Settings menu.

Field	Description
<b>Description</b>	Enter a description for the line.
<b>External Number</b>	Select a number configured as mini call centre for the external connection of this call centre line.
<b>Internal Number</b>	Enter the desired internal number for this line.
<b>Call Center Description</b>	Select <i>New</i> and enter a name for the new mini call centre.  Or select the name of a mini call centre which has already been generated.

**Fields in the Further Settings menu.**

Field	Description
<b>Switch call signalling</b>	Select whether the call options for this line shall be switched over a configured calendar and, if so, over which.  Possible values: <ul style="list-style-type: none"> <li>• <i>No calendar, only manually</i></li> <li>• <i>&lt;Calendar&gt;</i></li> </ul>
<b>Active Variant</b>	Select which call option shall be enabled by default after configuration for this line.

The menu **Advanced Settings** consists of the following fields:

**Fields in the Advanced Settings menu.**

Field	Description
<b>Team Speed Timer</b>	Enter the time after which call forwarding to the next free agent assigned to this line shall occur.

**13.7.2.2 Variant 1 - 4**

In the area **Variant**, you set up call options for the mini call centre.

The menu **Applications->Mini Call Center->Lines->Variant** consists of the following fields:

**Fields in the Settings menu.**

Field	Description
<b>Automatic Call Pick-up with</b>	Select whether an incoming call shall be automatically accepted and, if so, with which announcement or melody.  The function is activated by selecting <i>Enabled</i> .  The function is disabled by default.  Select the Wave file to be used for the call acceptance. All pre-set and additionally-loaded Wave files in the system can be selected.

**Fields in the Rerouting Functions menu.**



Field	Description
<b>Rerouting on no response</b>	<p>Select whether and, if so, with which option an incoming call shall be redirected after the entered time.</p> <p>Possible values:</p> <ul style="list-style-type: none"> <li>• <i>None</i>: There shall be no redirect on no-reply.</li> <li>• <i>&lt;Team&gt;</i>: The incoming call is forwarded to the selected team after the time specified in <b>Time until rerouting</b>.</li> </ul>
<b>Further Rerouting</b>	<p>Select additional redirect functions. You must first configure these in <b>Applications-&gt;Rerouting-&gt;Rerouting Functions</b>. Then, the following values may be selected:</p> <ul style="list-style-type: none"> <li>• <i>Off</i>: No additional redirect functions.</li> <li>• <i>Immediately</i>: Immediately transfers the call according to a configured redirect function.</li> <li>• <i>On Busy</i>: Transfers the call according to a configured redirect function on engaged.</li> </ul>
<b>Rerouting Function</b>	<p>Only for <b>Further Rerouting</b> = <i>Immediately</i> or <b>Further Rerouting</b> = <i>On Busy</i></p> <p>Select a configured redirect option for immediate redirect, or on busy.</p>
<b>Busy when</b>	<p>Only for <b>Further Rerouting</b> = <i>On Busy</i></p> <p>Select from how many busy agents the lines shall be considered busy.</p>

### 13.7.2.3 Log on / Log off

In the **Log on / Log off** area, select which of the assigned agents shall be logged into the line.

The menu **Applications->Mini Call Center->Lines->Log on / Log off** consists of the following fields:

#### Fields in the Log on / Log off menu.

Field	Description
<b>Numbers</b>	Displays the internal number and description of the assigned

Field	Description
	agent.
<b>Status</b>	Select whether the agent is logged into the line.  The agent is logged in by selecting <i>Logged on</i> .

### 13.7.3 Agents

In the **Applications->Mini Call Center->Agents** menu, lines are assigned to agents. An agent can operate one or more mini call centre lines.

#### 13.7.3.1 Edit or New

Choose the  icon to edit existing entries. Select the **New** button to create new entries.

The menu **Applications->Mini Call Center->Agents->New** consists of the following fields:

#### Fields in the Basic Settings menu.

Field	Description
<b>User</b>	Select the configured user who shall serve as a call centre agent. You configure required users in the <b>Numbering-&gt;User Settings-&gt;User</b> menu.  The following users are already created: <ul style="list-style-type: none"> <li>• <i>User 1 to User 4 analog phones</i></li> <li>• <i>User 5 and User 6 Sys Tel</i></li> <li>• <i>User 7 DECT</i></li> <li>• <i>User 8 and User 9 ISDN</i></li> </ul>
<b>Internal Number</b>	Select the user's internal number to be used for the call centre.

#### Fields in the Assigned Lines menu.

Field	Description
<b>Select lines</b>	Select the lines for which the agent shall be responsible. The name of the corresponding call centre is displayed again when lines are selected in order to improve the overview.  Under <b>Assign</b> select whether the entry should be enabled.

**Fields in the Wrap-up Settings menu.**

Field	Description
<b>Wrap-up Time</b>	Enter the time available to this agent for post-processing after concluding a call. No further call can be assigned to this agent during this period. The agent has the option of temporarily extending the period with a telephone procedure.

## 13.7.4 General

In the **Applications->Mini Call Center->General** menu, you can set up an HTML web interface access for the mini call centre manager. The latter can then monitor the status of lines and agents, and modify the settings for lines and agents.

The **Applications->Mini Call Center->General** menu consists of the following fields:

**Fields in the Basic Settings menu.**

Field	Description
<b>Web Access Username</b>	Enter a user name for the mini call centre administrator. When a user logs into the user interface under this name, he/she has access to the user interface with selected parameters for administration of the call centre.
<b>Web Access Password</b>	Enter a password for the mini call centre administrator.

## 13.8 Doorcom Units

You can connect a door intercom as an intercom adapter to an analogue connection of your system.

If a door intercom adapter is connected to your system, you can speak with a visitor at the door from every authorised telephone. You can assign particular telephones to each ring button. These phones then ring if the ring button is pressed. On analogue telephones, the signal on the telephone matches the intercom call. In place of the internal telephones, an external telephone can also be configured as the call destination for the ring button. Your door intercom can have up to 4 ring buttons. The door opener can be pressed during an intercom call. It is not possible activate the door opener if an intercom call is not taking place.

**Note**

All functions of the door intercom (intercom adapter) are controlled via the code numbers indicated in the intercom user's manual. The system does not support the intercom with specific codes.

## 13.8.1 Doorcom Units

In the **Applications->Doorcom Units->Doorcom Units** menu, select the internal analogue connection (FXS) to which an intercom adapter shall be connected. Then dial the internal number for the connection, and optionally the codes for call acceptance.

### 13.8.1.1 Edit or New

Choose the  icon to edit existing entries. Select the **New** button to create new entries.

If you intend to add **Doorcom Units**, you may first have to free an interface in the menu **Terminals->Other phones->Analogue**, i.e. delete one of the preconfigured entries with the  button.

The menu **Applications->Doorcom Units->Doorcom Units->New** consists of the following fields:

#### Fields in the **Basic Settings** menu.

Field	Description
<b>Interface</b>	Select the interface to which an intercom adapter shall be connected. All free FXS interfaces are available.
<b>Internal Number</b>	Select the configured internal number to be assigned to the intercom adapter. The number is created in the <b>Numbering-&gt;User Settings-&gt;User</b> menu.
<b>Code for Doorcom Call Acceptance</b>	Pressing a bell button on the intercom sets off a call in the system. To establish a connection between a called subscriber and the intercom adapter, that subscriber must pick up the receiver and dial the code number for call acceptance. Enter this code for call acceptance. If a subscriber accepts a call from the intercom adapter, the PABX automatically dials the code number required to set up the connection. The subscriber need not make any more entries.

## 13.8.2 Doorcom Signalling

In the **Applications->Doorcom Units->Doorcom Signalling** you configure the signalling variant for call acceptance via a intercom adapter. Two intercom call options are available.

The code number for the bell button is the number the intercom adapter dials into the system when the bell button is pressed. You can perform an internal call allocation for each bell button. Please note that guidelines for connecting the intercom adapter depend on the respective manufacturer. For this, read the operating instructions provided by the manufacturer of the intercom adapter.

### 13.8.2.1 General

In the **General** area you set up the basic features of intercom signalling.

The menu **Applications->Doorcom Units->Doorcom Signalling->General** consists of the following fields:

#### Fields in the Basic Settings menu.

Field	Description
<b>Description</b>	Select one of the configured intercom settings previously created in the <b>Applications-&gt;Doorcom Units-&gt;Doorcom Units</b> menu.
<b>Bell ID</b>	Enter an unambiguous four-digit code for the bell. Pressing a bell button on the intercom adapter initiates a call to the terminals entered in the assigned intercom call option.
<b>Bell Name</b>	Enter a name for the bell.
<b>Switch signalling</b>	Select whether the intercom call options for this bell shall be switched over a configured calendar and, if so, over which. For every ring, you can create up to two intercom call variants in the <b>Applications-&gt;Doorcom Units-&gt;Doorcom Signalling-&gt;New-&gt;Variant</b> menu.  Possible values: <ul style="list-style-type: none"> <li>• <i>No calendar, only manually</i></li> <li>• <i>&lt;Calendar&gt;</i></li> </ul>
<b>Active Doorcom Vari-</b>	Select which intercom call option shall be enabled by default for

Field	Description
<b>ant</b>	this bell after configuration.

The menu **Advanced Settings** consists of the following fields:

#### Fields in the **Advanced Settings** menu.

Field	Description
<b>Call Signalisation Timer</b>	Enter the time in seconds for which the door intercom call shall be signalled. The default value is 40 seconds.
<b>Team Speed Timer</b>	Here, enter the <b>Team Speed Timer</b> following which call forwarding after time shall be performed. The default value is 15 seconds.
<b>Simultaneous after time</b>	It is possible for all numbers assigned to this door intercom signalling to be called simultaneously after a specified time.  The default value is 60 seconds.

### 13.8.2.2 Doorcom Signalling Variant 1 and 2

In the **Doorcom Signalling Variant** area, you configure both intercom call options for this signalling profile.

The **Applications->Doorcom Units->Doorcom Signalling->Intercom call variant** consists of the following fields:

#### Fields in the **Basic Settings** menu.

Field	Description
<b>Assignment</b>	Select where pressing of the bell button shall be signalled.  Possible values: <ul style="list-style-type: none"> <li>• <i>Internal</i>: Signalling occurs on an internal number.</li> <li>• <i>External</i>: Signalling occurs to an external number.</li> </ul>
<b>Internal Assignment</b>	Select the internal numbers on which pressing of the door bell shall be signalled. With <b>Add</b> you add an internal number.
<b>External Assignment</b>	Enter the external telephone number to which pressing the door bell shall be signalled.

Field	Description
<b>Signalling</b>	<p>You can call the internal number with a broadcast call.</p> <p>Possible values:</p> <ul style="list-style-type: none"> <li>• <i>Simultaneous</i> (default value): All assigned terminals are called simultaneously. If a telephone is busy, call waiting can be used.</li> <li>• <i>Linear</i>: All assigned terminals are called in the sequence of their entry in configuration. If a terminal is engaged, the next free terminal is called. The call is signalled ca. 15 seconds per subscriber. The period can be set between 1 and 99 seconds (per bell) in the configuration. If subscribers are on the phone or logged out, there is not forwarding time for these.</li> <li>• <i>Rotating</i>: This call is a special case of the linear call. After all terminals are called, call signalling begins again with the first entered terminal. The call is signalled until the caller replaces the receiver or the call is ended by the intercom adapter (after ca. 2 minutes).</li> <li>• <i>Adding</i>: The terminals are called in the sequence of their entry in the configuration subscriber list. Every terminal that has already been called is called again, until all entered terminals are called. In the configuration, you can define when each next terminal is called.</li> <li>• <i>Linear, simultaneous after time</i>: You have set linear for the door intercom call. After the defined time has run out, you can also set in the configuration that all team subscribers are then called in parallel (simultaneously).</li> <li>• <i>Rotating, simultaneous after time</i>: You have set rotating for the door intercom call. After the defined time has run out, you can also set in the configuration that all intercom subscribers are then called in parallel (simultaneously).</li> </ul>

## 13.9 Voice Mail System

The voicemail system is an intelligent answering machine for those who use your PABX. An individual voicemail box can be configured for each extension. All subscribers can hear, save or delete their messages from any telephone using a personal PIN code.

Subscribers can have themselves informed of incoming e-mails. Recorded messages can be automatically transferred to any e-mail address.

General settings of the voicemail system are performed on your PABX. Operation of the individual voicemail boxes occurs via telephone.

Every subscriber can use her individual voicemail box by transferring calls to her voicemail box.



#### Note

If you wish to use a voicemail box, you'll need an installed SD card (if supported by your device). You may need load the required folder structure with the announcement texts on the SD card. Choose in the **Maintenance->Software & Configuration** menu the option *Import Voice Mail Wave Files*.



#### Caution

Do not remove the SD card during any read or write access to avoid losing data or damaging the card. Watch the relevant LED on the top of the device: it will flicker during any read or write access.

## 13.9.1 Voice Mail Boxes

In the **Applications->Voice Mail System->Voice Mail Boxes** menu, a list of the individual voicemail boxes for specific subscribers is displayed.

Only for compact systems.

Two predefined voicemail boxes are displayed:

Internal Number	User	License Allocation
10	User 1 analog phone	Enabled
20	User 5 Sys Tel	Enabled

#### Values in the list Voice Mail Boxes

Field	Description
<b>Internal Number</b>	Displays the number of the individual subscriber for which the voicemail box is configured.
<b>User</b>	Displays the name of the individual subscriber for which the voicemail box is configured.



Field	Description
<b>Language</b>	Displays the language of the announcement text on the voicemail box. <i>Default</i> means that the centrally-set language, defined for the entire voicemail system in the <b>Applications-&gt;Voice Mail System-&gt;General</b> menu, is used.
<b>Notification</b>	Indicates whether the subscriber is informed of missed calls.
<b>Active Variant</b>	Indicates the current status of the voicemail box ( <i>In the Office</i> or <i>Out of Office</i> ).
<b>License Allocation</b>	Indicates whether a licence is currently assigned to a voicemail box.



**Note**

The number of configured voicemail boxes may exceed the number of existing licences. However, you must make sure that the number of currently used voicemail boxes is covered by the number of licences.

### 13.9.1.1 Edit or New

Choose the  icon to edit existing entries. Select the **New** button to create new entries.

The menu **Applications->Voice Mail System ->Voice Mail Boxes ->New** consists of the following fields:

#### Fields in the menu **Basic Settings**

Field	Description
<b>Internal Number</b>	Select the internal number of the subscriber for which you wish to set up a voicemail box. You may choose among the numbers configured in the <b>Numbering-&gt;User Settings-&gt;User</b> menu.
<b>Voice Mail Language</b>	Select the desired language for the voicemail box announcements.  Possible values: <ul style="list-style-type: none"> <li>• <i>Deutsch</i>: The voicemail box uses German texts.</li> <li>• <i>Dutch</i>: The voicemail box uses Dutch texts.</li> </ul>

Field	Description
	<ul style="list-style-type: none"> <li>• <i>English</i>: The voicemail box uses English texts.</li> <li>• <i>Italian</i>: The voicemail box uses Italian texts.</li> <li>• <i>Spanish</i>: The voicemail box uses Spanish texts.</li> <li>• <i>French</i>: The voicemail box uses French texts.</li> <li>• <i>Portugues</i>: The voicemail box uses Portugues texts.</li> <li>• <i>Default</i> (default value): The voicemail box uses the language centrally defined for the entire voicemail system in the <b>Applications-&gt;Voice Mail System -&gt;General</b> menu.</li> </ul> <div data-bbox="541 553 1319 741" style="border: 1px solid #ccc; background-color: #f0f0f0; padding: 10px; margin-top: 10px;">  <p><b>Note</b></p> <p>You'll only require a setting that departs from <i>Default</i> if you wish to operate voicemail boxes with various languages within your voicemail system.</p> </div>
<b>E-Mail Address (from User Settings)</b>	<p>Here is displayed the user e-mail address to which a notification shall be sent if a message has been left on the voicemail box. The e-mail address is saved in the <b>Numbering-&gt;User Settings-&gt;User-&gt;Basic Settings</b> menu.</p>
<b>E-Mail Notification</b>	<p>Once a message has been left on the voicemail box, the subscriber can be notified.</p> <p>Possible values:</p> <ul style="list-style-type: none"> <li>• <i>None</i> (default value): The subscriber is not notified.</li> <li>• <i>E-Mail</i>: The subscriber is informed of a present message via e-mail.</li> <li>• <i>E-Mail with Attachment</i>: Once a caller has left a message, the subscriber receives an e-mail with a recording of the message in the attachment.</li> <li>• <i>User defined</i>: If the administrator activates the <i>User defined</i> function, the e-mail alert settings can be changed by the user in the <b>User Access</b>. If the administrator sets a different value, a block is placed on changes from the user.</li> </ul>

Field	Description
	 <p><b>Note</b></p> <p>Once a subscriber has received notification of a new message in an e-mail, the <b>Status</b> of the notification is changed according to the settings in the <b>User Access</b>. You can configure the status behaviour in the <b>User Access-&gt;Voice Mail System-&gt;Settings</b> menu under <b>E-Mail forwarding behavior</b>.</p>
<b>Max Recording Time</b>	Enter the maximum recording time per message. The possible values are 5 to 300 seconds, the default value is 180 seconds.
<b>Calendar for status "Out of Office"</b>	<p>When the subscriber is out, the voicemail box can be switched over a calendar.</p> <p>If a calendar is to be used, it needs to be configured with the setting <b>Application</b> = <i>Voice Mail System</i> in the menu <b>Applications-&gt;Calendar</b>.</p> <p>Possible values:</p> <ul style="list-style-type: none"> <li>• <i>No calendar, only manually</i> (default value): The subscriber can manually switch the voicemail box on and off.</li> <li>• &lt;Calendar&gt;: Using the selected calendar, the voicemail box can be switched on or off at the times defined there.</li> </ul>

#### Fields in the menu **User Settings**

Field	Description
<b>Status of Mail Box Owner</b>	<p>Define in which mode the mailbox shall be used when starting the voicemail system.</p> <p>Possible values:</p> <ul style="list-style-type: none"> <li>• <i>In the Office</i> (default value): Select this setting if the subscriber is in the office when the voicemail system is started.</li> <li>• <i>Out of Office</i>: Select this setting if the subscriber is out of office when the voicemail system is started.</li> </ul>
<b>Check PIN</b>	Select whether the currently configured voicemail box should be protected with a PIN.

Field	Description
	<p>The function is enabled with <i>Enabled</i>.</p> <p>The function is disabled by default.</p> <p>You can change the PIN for the personal voice box in the <b>Numbering-&gt;User Settings-&gt;Users-&gt;Authorizations</b> under <b>PIN for Phone Access</b>.</p>
<b>Mode for status "In the Office"</b>	<p>The voicemail box can be operated with two different settings during office hours.</p> <p>Possible values:</p> <ul style="list-style-type: none"> <li>• <i>Announcement and Record</i> (default value): A caller hears an announcement and can leave a message.</li> <li>• <i>Announcement only</i>: A caller hears an announcement, but cannot leave a message.</li> </ul>
<b>Mode for status "Out of Office"</b>	<p>The voicemail box can be operated with two different settings outside of office hours.</p> <p>Possible values:</p> <ul style="list-style-type: none"> <li>• <i>Announcement only</i> (default value): A caller hears an announcement, but cannot leave a message.</li> <li>• <i>Announcement and Record</i>: A caller hears an announcement and can leave a message.</li> </ul>

## 13.9.2 Status

In the **Applications->Voice Mail System->Status** menu, the status of the individual voicemail boxes for specific subscribers is indicated. You can see how many calls have gone in to which voicemail box, and how many "old" calls are already present.

### Values in the System Messages list

Field	Description
<b>Internal Number</b>	Displays the number of the individual subscriber for which the voicemail box is configured.
<b>User</b>	Displays the name of the individual subscriber for which the voicemail box is configured.

Field	Description
<b>New Calls</b>	Displays the calls which have not yet been listened to by the subscriber.
<b>Old Calls</b>	Displays the calls which have already been listened to or stored by the subscriber.

### 13.9.3 General

In this menu, you can configure the general settings for your voicemail system.

The menu **Applications->Voice Mail System ->General** consists of the following fields:

#### Fields in the menu **Basic Settings**

Field	Description
<b>Voice Mail System</b>	Select whether to activate your voicemail system.  The function is enabled with <i>Enabled</i> .  The function is enabled by default.
<b>Description</b>	Only for <b>Voice Mail System</b> enabled.  Enter a description for your voicemail system. This description is displayed on the telephone when a call goes in to the voice mail system.  The default value is <i>Voice Mail</i> .
<b>Internal Number</b>	Only for <b>Voice Mail System</b> enabled.  Enter the internal number under which to access your voicemail system.  The default value is <i>50</i> .
<b>Language</b>	Select the language for the entire voicemail system.  Possible values: <ul style="list-style-type: none"> <li>• <i>Deutsch</i> (default value)</li> <li>• <i>Dutch</i></li> <li>• <i>English</i></li> </ul>

Field	Description
	<ul style="list-style-type: none"> <li>• <i>Italian</i></li> <li>• <i>Spanish</i></li> <li>• <i>French</i></li> <li>• <i>Portugues</i></li> </ul> <p>Diverging from the language set here, a language can be individually set for each voice mail box in the <b>Applications+Voice Mail System-&gt;Voice Mail Boxes-&gt;New</b> menu.</p>

#### Fields in the menu Mail Settings

Field	Description
<b>SMTP Server</b>	Enter the address (IP address or valid DNS name) of the e-mail server to be used for sending the e-mails.
<b>SMTP Server Port</b>	Enter the port to be used for sending e-mails.  The default value is <i>25</i> .
<b>Return Address</b>	Enter any address to be used as sender when sending e-mails. This address merely serves to identify e-mails in the inbox.
<b>SMTP User Name</b>	Enter the user name for the SMTP server.
<b>SMTP Password</b>	Enter the password for the SNMP server user.

The menu **Advanced Settings** consists of the following fields:

#### Fields in the menu Advanced Settings

Field	Description
<b>Lifetime</b>	<p>Voicemail messages are deleted after an adjustable period of time.</p> <p>Possible values are <i>10</i> to <i>60</i> days. The default value is <i>60</i>.</p>

## Chapter 14 LAN

In this menu, you configure the addresses in your LAN and can structure your local network using VLANs.

### 14.1 IP Configuration

In this menu, you can edit the IP configuration of the LAN and Ethernet interfaces of your device.



#### 14.1.1 Interfaces

The existing IP interfaces are listed in the **LAN->IP Configuration->Interfaces** menu. You can edit the IP configuration of the interfaces or create virtual interfaces for special applications. Here is a list of all of the interfaces (logical Ethernet interfaces and others created in the subsystems) configured in the **System Management->Interface Mode / Bridge Groups->Interfaces** menu.

Use the  to edit the settings of an existing interface (bridge groups, Ethernet interfaces in routing mode).

You can use the **New** button to create virtual interfaces. However, this is only needed in special applications (e.g. BRRP).

Depending on the option selected, different fields and options are available. All the configuration options are listed below.

Change the status of the interface by clicking the  or the  button in the **Action** column.

Press the  button to display the details of an existing interface.



#### Note

For IPv4 note that:

If your device has obtained an IP address dynamically from a DHCP server operated in your network for the basic configuration, the default IP address is deleted automatically and your device will no longer function over this address.

However, if you have set up a connection to the device over the default IP address or have assigned an IP address with the **Dime Manager** in the basic configuration, you

will only be able to access your device over this IP address. The device will no longer obtain an IP configuration dynamically over DHCP.

### Example of subnets

If your device is connected to a LAN that consists of two subnets, you should enter a second **IP Address / Netmask**.

The first subnet has two hosts with the IP addresses 192.168.42.1 and 192.168.42.2, for example, and the second subnet has two hosts with the IP addresses 192.168.46.1 and 192.168.46.2. To be able to exchange data packets with the first subnet, your device uses the IP address 192.168.42.3, for example, and 192.168.46.3 for the second subnet. The netmasks for both subnets must also be indicated.

Here is an example for an IPv6 address:

Your device can act either as router or as device at one interface. In general, it acts as router at the LAN interfaces, and as host at the WAN and PPP interfaces.

If your device acts as router, its own IPv6 addresses can be created as follows: a Link Prefix can be derived from a General Prefix or you can manually specify a static value. One host address can be created through *Auto eui-64*, for additional host addresses you can specify static values.

If your device acts a router, it commonly distributes the configured link prefix to the hosts through Router Advertisements. A DHCP server may distribute additional information to the hosts, e.g., the address of a timer server. A client can create its own host address either through Stateless Address Autoconfiguration (SLAAC) or have this address assigned by a DHCP server.

In order to make use of the router mode described above, use the following settings in the menu **LAN->IP Configuration->Interfaces->New: IPv6 Mode = Router, Transmit Router Advertisement = Enabled, DHCP Server Enabled and IPv6 Addresses = Add.**

If your device acts as host, it has a Link Prefix assigned by another router through Router Advertisements. The host address is then automatically derived through SLAAC. Additional information like, e.g., the General Prefix of the provider or the address of a time server can be received through DHCP. Use the following settings in the menu **LAN->IP Configuration->Interfaces->New: IPv6 Mode = Client, Accept Router Advertisement = Enabled and DHCP Client = Enabled.**



### 14.1.1.1 Edit or New

Choose the  icon to edit existing entries. Choose the **New** button to create virtual interfaces.

The **LAN->IP Configuration->Interfaces->/New** menu consists of the following fields:

#### Fields in the **Basic Parameters** menu.

Field	Description
<b>Based on Ethernet Interface</b>	<p>This field is only displayed if you are editing a virtual routing interface.</p> <p>Select the Ethernet interface for which the virtual interface is to be configured.</p>
<b>Interface Mode</b>	<p>Only for physical interfaces in routing mode and for virtual interfaces.</p> <p>Select the configuration mode of the interface.</p> <p>Possible values:</p> <ul style="list-style-type: none"> <li>• <i>Untagged</i> (default value): The interface is not assigned for a specific purpose.</li> <li>• <i>Tagged (VLAN)</i>: This option only applies for routing interfaces.</li> </ul> <p>You use this option to assign the interface to a VLAN. This is done using the VLAN ID, which is displayed in this mode and can be configured. The definition of a MAC address in <b>MAC Address</b> is optional in this mode.</p>
<b>VLAN ID</b>	<p>Only for <b>Interface Mode</b> = <i>Tagged (VLAN)</i></p> <p>This option only applies for routing interfaces. Assign the interface to a VLAN by entering the VLAN ID of the relevant VLAN.</p> <p>Possible values are <i>1</i> (default value) to <i>4094</i>.</p>
<b>MAC Address</b>	<p>Enter the MAC address associated with the interface. For virtual interfaces, you can use the MAC address of the physical interface under which the virtual interface was created by activating <b>Use built-in</b>, but VLAN IDs must be different. You can also al-</p>

Field	Description
	<p>locate a virtual MAC address. The first 6 characters of the MAC are preset (but can be changed).</p> <p>If <b>Use built-in</b> is active, the predefined MAC address of the allocated physical interface is used.</p> <p><b>Use built-in</b> is activated by default.</p>

#### Fields in the **Basic IPv4 Parameters** menu.

Field	Description
<b>Security Policy</b>	<p>Select the security settings to be used with the interface.</p> <p>Possible values:</p> <ul style="list-style-type: none"> <li>• <i>Trusted</i> (default value): All IP packets are allowed through except for those which are explicitly prohibited..</li> <li>• <i>Untrusted</i>: Only those packets are transmitted that can be attributed to a connection that has been initiated from a trusted zone.</li> </ul> <p>You can configure exceptions for the selected setting in the <a href="#">Firewall</a> on page 460 menu.</p>
<b>Address Mode</b>	<p>Select how an IP address is assigned to the interface.</p> <p>Possible values:</p> <ul style="list-style-type: none"> <li>• <i>Static</i> (default value): The interface is assigned a static IP address in <b>IP Address / Netmask</b>.</li> <li>• <i>DHCP</i>: An IP address is assigned to the interface dynamically via DHCP.</li> </ul>
<b>IP Address / Netmask</b>	<p>Only for <b>Address Mode</b> = <i>Static</i></p> <p>With <b>Add</b>, add a new address entry, enter the <b>IP Address</b> and the corresponding <b>Netmask</b> of the virtual interface.</p>

#### Fields in the **Basic IPv6 Parameters** menu.

Field	Description
<b>IPv6</b>	<p>Select whether this interface should use Internet Protocol version 6 (IPv6) for data transmission.</p> <p>The function is activated by selecting <i>Enabled</i>.</p>

Field	Description
	The function is disabled by default.
<b>Security Policy</b>	<p>Only for <b>IPv6 = Enabled</b>            Select the security settings to be used with the interface.</p> <p>Possible values:</p> <ul style="list-style-type: none"> <li>• <i>Trusted</i> (default value): All IP packets are allowed through except for those which are explicitly prohibited.</li> </ul> <p>We recommend you use this setting if you want to use IPv6 on your LAN.</p> <ul style="list-style-type: none"> <li>• <i>Untrusted</i>: Only those packets are transmitted that can be attributed to a connection that has been initiated from a trusted zone.</li> </ul> <p>We recommend you use this setting if you want to use IPv6 outside of your LAN.</p> <p>You can configure exceptions for the selected setting in the <a href="#">Firewall</a> on page 460 menu.</p>
<b>IPv6 Mode</b>	<p>Only for <b>IPv6 = Enabled</b></p> <p>Select whether the interface is to be operated in host or in router mode. Depending on your selection different parameters are presented for you to configure.</p> <p>Possible values:</p> <ul style="list-style-type: none"> <li>• <i>Router (Transmit Router Advertisement)</i> (default value): The interface connects different networks to each other.</li> <li>• <i>Host</i>: The interface is operated in host mode.</li> </ul>
<b>Transmit Router Advertisement</b>	<p>Only for <b>IPv6 = Enabled</b> and <b>IPv6 Mode = Router (Transmit Router Advertisement)</b></p> <p>Select whether Router Advertisements are to be sent via the interface.</p> <p>Using Router Advertisements the list of prefixes is propagated and the router propagates itself as the standard gateway.</p> <p>The function is activated by selecting <i>Enabled</i>.</p>

Field	Description
	The function is enabled by default.
<b>DHCP Server</b>	<p>Only for <b>IPv6</b> = <i>Enabled</i> and <b>IPv6 Mode</b> = <i>Router (Transmit Router Advertisement)</i></p> <p>Specify if your device is to act as DHCP server, i.e., if it is to transmit DHCP options in order to distribute information about the DNS servers to the clients.</p> <p>Enable this option if hosts are to create IPv6 addresses through SLAAC.</p> <p>The function is activated by selecting <i>Enabled</i>.</p> <p>The function is enabled by default.</p>
<b>IPv6 Addresses</b>	<p>Only for <b>IPv6</b> = <i>Enabled</i></p> <p>You can assign <b>IPv6 Addresses</b> to the selected interface..</p> <p><b>Add</b> allows you to create one or more address entries.</p> <p>A new windows opens that allows you to specify an IPv6 address consisting of a Link Prefix and a host identifier.</p> <p>If your device operates in host mode (<b>IPv6 Mode</b> = <i>Host</i>, <b>Accept Router Advertisement</b> = <i>Enabled</i> and <b>DHCP Client</b> = <i>Enabled</i>), its IPv6 addresses are determined through SLAAC. You need not configure an IPv6 address manually, but you can enter additional addresses if desired.</p> <p>If your device is operating in router mode (<b>IPv6 Mode</b> = <i>Router (Transmit Router Advertisement)</i>, <b>Transmit Router Advertisement</b> = <i>Enabled</i> and <b>DHCP Server</b> = <i>Enabled</i>), you need to configure its IPv6 addresses here.</p>
<b>Accept Router Advertisement</b>	<p>Only for <b>IPv6</b> = <i>Enabled</i> and <b>IPv6 Mode</b> = <i>Host</i></p> <p>Select if Router Advertisements are to be received on the selected interface. Router Advertisements are used, e.g., to create the prefix list.</p> <p>The function is activated by selecting <i>Enabled</i>.</p> <p>The function is enabled by default.</p>

Field	Description
<b>DHCP Client</b>	<p>Only for <b>IPv6 = Aktiviert</b> and <b>IPv6 Mode = Host</b></p> <p>Select if your device is to act as DHCP client, i.e., if it is to receive DHCP options in order to obtain information about the DNS servers.</p> <p>The function is activated by selecting <i>Enabled</i>.</p> <p>The function is enabled by default.</p>

Use **Add** to create more entries.

#### Fields in the **Basic Parameters** menu.

Field	Description
<b>Advertise</b>	<p>Only for <b>IPv6 Mode = Router (Transmit Router Advertisement)</b></p> <p>Here you can determine if the prefix being defined in the current window is propagated per Router Advertisement over the selected interface.</p> <p>The function is activated by selecting <i>Enabled</i>.</p> <p>The function is enabled by default.</p>

#### Fields in the **Link Prefix** menu.

Field	Description
<b>Setup Mode</b>	<p>Select in which way the Link Prefix is to be determined.</p> <p>Possible values:</p> <ul style="list-style-type: none"> <li>• <i>From General Prefix</i> (default value): The Link Prefix is derived from a General Prefix.</li> <li>• <i>Static</i>: You can enter the link prefix.</li> </ul>
<b>General Prefix</b>	<p>Only for <b>Setup Mode = From General Prefix</b></p> <p>Select the General Prefix the Link Prefix is to be derived from. You can choose from the General Prefixes available under <b>Network-&gt;IPv6 General Prefixes-&gt;General Prefix Configuration-&gt;New</b>.</p>

Field	Description
<b>Auto Subnet Configuration</b>	<p>Only if <b>Setup Mode</b> = <i>From General Prefix</i> and if a General Prefix has been selected.</p> <p>Select if the subnet is to be created automatically. Automatic subnet creation will use ID 0 for the first subnet, ID 1 for the second, etc.</p> <p>Possible values for the sub net ID are: 0 - 65535.</p> <p>The subnet ID describes the fourth of the four 16 bit fields of a Link Prefix. Upon subnet creation the decimal ID value is converted to a hexadecimal one.</p> <p>The function is activated by selecting <i>Enabled</i>.</p> <p>The function is enabled by default.</p> <p>If the function is disabled, you can define a subnet by entering a Subnet ID.</p>
<b>Subnet ID</b>	<p>Only if <b>Auto Subnet Configuration</b> is not active.</p> <p>Enter a Subnet ID in order to define a subnet. The subnet ID describes the fourth of the four 16 bit fields of a Link Prefix.</p> <p>Possible values are 0 - 65535.</p> <p>Upon subnet creation the decimal ID value is converted to a hexadecimal one.</p>
<b>Link Prefix</b>	<p>Only for <b>Setup Mode</b> = <i>Static</i></p> <p>You can specify the Link Prefix of an IPv6 address. This prefix must end with <i>::</i>. Its predetermined length is 64.</p>

#### Fields in the Host Address menu.

Field	Description
<b>Generation Mode</b>	<p>Determine if the Host Identifier of the IPv6 address is to be automatically derived from the MAC address through EUI-64.</p> <p>The function is activated by selecting <i>Enabled</i>.</p> <p>The function is enabled by default.</p> <p>EUI-64 triggers the following process:</p>

Field	Description
	<ul style="list-style-type: none"> <li>The hexadecimal 48 bit MAC address is split into 2 x 24 bit.</li> <li><i>FFFE</i> is inserted into the created gap in order to obtain 64 bit.</li> <li>The hexadecimal notation of the 64 bit is converted to a binary notation.</li> <li>Bit no. 7 of the first 8 bit field is set to <i>1</i>.</li> </ul>
<b>Static Addresses</b>	Independently of the automatic creation described under <b>Generation Mode</b> , you can manually specify the Host Identifier of one or more IPv6 addresses with <b>Add</b> . Its predefined length is <i>64</i> . Start any entry with <i>: : .</i>

The fields in the **Advanced** menu are part of the prefix information sent inside of Router Advertisements if **Advertise** is enabled. The menu **Advanced** consists of the following fields:

#### Fields in the **Advanced IPv6 Settings** menu

Field	Description
<b>On Link Flag</b>	<p>Select whether the On-Link Flag (L-Flag) should be set. This allows the host to enter the prefix from the prefix list.</p> <p>The function is activated by selecting <i>True</i> .</p> <p>The function is enabled by default.</p>
<b>Autonomous Flag</b>	<p>Select whether the Autonomous Address Configuration Flag (A-Flag) should be set. This allows the host to use the prefix and the 64 bit interface ID, to derive its address.</p> <p>The function is activated by selecting <i>True</i> .</p> <p>The function is enabled by default.</p>
<b>Preferred Lifetime</b>	<p>Enter a time period in seconds. During this time, addresses derived from the prefix through SLAAC are preferred.</p> <p>The default value is <i>604800</i> seconds.</p>
<b>Valid Lifetime</b>	<p>Enter a time period in seconds, for which the prefix is valid.</p> <p>The default value is <i>2592000</i> seconds.</p>

Field	Description
	<div style="border: 1px solid gray; padding: 10px;">  <p><b>Note</b></p> <p>The value for the valid lifetime should be lower than the one configured for the option <b>Router Lifetime</b> under <b>Advanced IPv6 Settings</b>.</p> </div>

The menu **Advanced Settings** consists of the following fields:

#### Fields in the **Advanced IPv4 Settings** menu.

Field	Description
<b>DHCP MAC Address</b>	<p>Only for <b>Address Mode</b> = <i>DHCP</i></p> <p>If <b>Use built-in</b> is activated (default setting), the hardware MAC address of the Ethernet interface is used. In the case of physical interfaces, the current MAC address is entered by default.</p> <p>If you disable <b>Use built-in</b>, you enter a MAC address for the virtual interface, e.g. <i>00:e1:f9:06:bf:03</i>.</p> <p>Some providers use hardware-independent MAC addresses to allocate their clients IP addresses dynamically. If your provider has assigned you a MAC address, enter this here.</p>
<b>DHCP Hostname</b>	<p>Only for <b>Address Mode</b> = <i>DHCP</i></p> <p>Enter the host name requested by the provider. The maximum length of the entry is 45 characters.</p>
<b>DHCP Broadcast Flag</b>	<p>Only for <b>Address Mode</b> = <i>DHCP</i></p> <p>Choose whether or not the BROADCAST bit is set in the DHCP requests for your device. Some DHCP servers that assign IP addresses by UNICAST do not respond to DHCP requests with the set BROADCAST bit. In this case, it is necessary to send DHCP requests in which this bit is not set. In this case, disable this option.</p> <p>The function is activated by selecting <i>Enabled</i>.</p> <p>The function is enabled by default.</p>
<b>Proxy ARP</b>	Select whether your device is to respond to ARP requests from



Field	Description
	<p>its own LAN on behalf of defined remote terminals.</p> <p>The function is activated by selecting <i>Enabled</i>.</p> <p>The function is disabled by default.</p>
<b>TCP-MSS Clamping</b>	<p>Select whether your device is to apply MSS Clamping. To prevent IP packets fragmenting, the MSS (Maximum Segment Size) is automatically decreased by the device to the value set here.</p> <p>The function is activated by selecting <i>Enabled</i>.</p> <p>The function is disabled by default. Once enabled, the default value <i>1350</i> is entered in the input field.</p>

#### Fields in the **Advanced IPv6 Settings** menu

Field	Description
<b>Router Lifetime</b>	<p>Only for <b>IPv6</b> = <i>Enabled</i>, <b>IPv6 Mode</b> = <i>Router (Transmit Router Advertisement)</i> and <b>Transmit Router Advertisement</b> = <i>Enabled</i></p> <p>Enter a time period in seconds. The router remains in the default router list throughout this interval.</p> <p>The default value is <i>600</i> seconds. The maximum value is <i>65520</i> seconds. A value of <i>0</i> means that the router is not a default router, and will not be entered in the default router list.</p>
	<p> <b>Note</b></p> <p>The value for the <b>Router Lifetime</b> should be higher than the shortest valid lifetime for a link prefix configured for this interface under <b>Basic IPv6 Parameters</b>.</p>
<b>Router Preference</b>	<p>Only for <b>IPv6</b> = <i>Enabled</i>, <b>IPv6 Mode</b> = <i>Router (Transmit Router Advertisement)</i> and <b>Transmit Router Advertisement</b> = <i>Enabled</i></p> <p>Select your router's preference for choice of default router. This is useful for cases where a node receives advertisements from multiple routers, or for back-up scenarios.</p>

Field	Description
	<p>Possible values:</p> <ul style="list-style-type: none"> <li>• <i>High</i></li> <li>• <i>Medium</i> (default value)</li> <li>• <i>Low</i></li> </ul>
<p><b>DHCP Mode</b></p>	<p>Only for <b>IPv6 = Enabled</b>, <b>IPv6 Mode = Router (Transmit Router Advertisement)</b> and <b>Transmit Router Advertisement = Enabled</b></p> <p>Select the information to be forwarded to the DHCP client.</p> <div data-bbox="539 604 1315 758" style="background-color: #f0f0f0; padding: 10px; border: 1px solid #ccc;"> <p> <b>Note</b></p> <p>To achieve this, your router must not be set up as a DHCP server.</p> </div> <p>By selecting <i>Other - DNS Servers, SIP Servers</i> (default value) no address- related information, such as i.e. DNS, VoIP, etc., is passed through.</p> <p>Enable this option if hosts inside of the network are to automatically create their IP addresses through SLAAC. In this case, the router sends only data via DHCP that are not address-related.</p> <p>By selecting <i>Managed - IPv6 Address Management</i> hosts receive IPv6 addresses as well as not address-related information through DHCP.</p>
<p><b>DNS Propagation</b></p>	<p>Only for <b>IPv6 Mode = Router (Transmit Router Advertisement)</b> and <b>Transmit Router Advertisement Enabled</b></p> <p>Select if an in which way DNS server addresses are to be propagated in Router Advertisements. A maximum of two DNS server addresses is propagated.</p> <p>Possible values:</p> <ul style="list-style-type: none"> <li>• <i>Off</i>: No DNS server address propagation</li> <li>• <i>Self</i>: The device sends its own IP address as DNS server address. If the device has multiple addresses, they are used in the following order:</li> </ul>

Field	Description
	<ul style="list-style-type: none"> <li>• Global addresses</li> <li>• ULA (Unique Local Addresses)</li> <li>• Link local addresses</li> <li>• <i>Other</i>: Statically configured as well as dynamically learned DNS server entries are propagated according to their priority. If there are no entries, no address is propagated.</li> </ul>

## 14.2 VLAN

By implementing VLAN segmentation in accordance with 802.1Q, you can configure VLANs on your device. The wireless ports of an access point, in particular, are able to remove the VLAN tag of a frame sent to the clients and to tag received frames with a pre-defined VLAN ID. This functionality makes an access point nothing less than a VLAN-compliant switch with the enhancement of grouping clients into VLAN groups. In general, VLAN segmenting can be configured with all interfaces.

### VLAN for Bridging and VLAN for Routing

In the **LAN->VLAN** menu, VLANs (virtual LANs) are configured with interfaces that operate in Bridging mode. Using the **VLAN** menu, you can make all the settings needed for this and query their status.



#### Caution

For interfaces that operate in Routing mode, you only assign a VLAN ID to the interface. You define this via the parameters **Interface Mode** = *Tagged (VLAN)* and field **VLAN ID** in menu **LAN->IP Configuration->Interfaces->New**.

### 14.2.1 VLANs

In this menu, you can display all the VLANs already configured, edit your settings and create new VLANs. By default, the *Management* VLAN with **VLAN Identifier** = 1 is available, to which all interfaces are assigned.

### 14.2.1.1 Edit or New

Choose the  icon to edit existing entries. Select the **New** button in order to create new VLANs.

The **LAN->VLAN->VLANs->New** menu consists of the following fields:

#### Fields in the **Configure VLAN** menu.

Field	Description
<b>VLAN Identifier</b>	Enter the number that identifies the VLAN. In the  menu, you can no longer change this value.  Possible values are <i>1</i> (default value) to <i>4094</i> .
<b>VLAN Name</b>	Enter a unique name for the VLAN. A character string of up to 32 characters is possible.  The predefined VLAN name is <i>Management</i> .
<b>VLAN Members</b>	Select the ports that are to belong to this VLAN. You can use the <b>Add</b> button to add members.  For each entry, also select whether the frames to be transmitted from this port are to be transmitted <i>Tagged</i> (i.e. with VLAN information) or <i>Untagged</i> (i.e. without VLAN information).

### 14.2.2 Port Configuration

In this menu, you can define and view the rules for receiving frames at the VLAN ports.

The **LAN->VLANs->Port Configuration** menu consists of the following fields:

#### Fields in the **Port Configuration** menu.

Field	Description
<b>Interface</b>	Shows the port for which you define the PVID and processing rules.
<b>PVID</b>	Assign the selected port the required PVID (Port VLAN Identifier).  If a packet without a VLAN tag reaches this port, it is assigned

Field	Description
	this PVID.
<b>Drop untagged frames</b>	If this option is enabled, untagged frames are discarded. If the option is disabled, untagged frames are tagged with the PVID defined in this menu.
<b>Drop non-members</b>	If this option is enabled, all tagged frames that are tagged with a VLAN ID to which the selected port does not belong are discarded.

### 14.2.3 Administration

In this menu, you make general settings for a VLAN. The options must be configured separately for each bridge group.

The **LAN->VLANs->Administration** menu consists of the following fields:

#### Fields in the Bridge Group br<ID> VLAN Options menu

Field	Description
<b>Enable VLAN</b>	<p>Enable or disable the specified bridge group for VLAN.</p> <p>The function is enabled with <i>Enabled</i>.</p> <p>The function is not activated by default.</p>
<b>Management VID</b>	Select the VLAN ID of the VLAN in which your device is to operate.

## Chapter 15 Wireless LAN Controller

By using the wireless LAN controller, you can set up and manage a WLAN infrastructure with multiple access points (APs). The WLAN controller has a Wizard which assists you in the configuration of your access points. The system uses the CAPWAP protocol (Control and Provisioning of Wireless Access Points Protocol) for any communication between masters and slaves.

In smaller WLAN infrastructures with up to six APs, one of the AP's assumes the master function and manages the other AP's as well as itself. In larger WLAN networks a gateway, e.g. such as a **bintec R1202**, assumes the master function and manages the AP's.

Provided the controller has "located" all of the APs in its system, each of these shall receive a new passport and configuration in succession, i.e. they are managed via the WLAN controller and can no longer be amended "externally".

With the **WLAN controller** you can

- automatically detect individual access points (APs) and connect to a WLAN network
- Load the system software into the APs
- Load the configuration into the APs
- Monitor and manage APs

Please refer to your gateway's data sheet to find out the number of APs that you can manage with your gateway's wireless LAN controller and details of the licenses required.

### 15.1 Wizard

The **Wizard** menu offers step-by-step instructions for the set up of a WLAN infrastructure. The Wizard guides you through the configuration.

When you select the Wizard you will receive instructions and explanations on the separate pages of the Wizard.



#### Note

We highly recommend that you use the Wizard when initially configuring your WLAN infrastructure.

## 15.1.1 Basic Settings

Here you can configure all of the various settings that you require for the actual wireless LAN controller.

The wireless LAN controller uses the following settings:

### Region

Select the country in which the wireless controller is to be operated.

Please note: The range of channels that can be used varies depending on the country setting.

### Interface

Select the interface to be used for the wireless controller.

### DHCP Server

Select whether an external DHCP server shall assign IP addresses to the APs or if you wish to assign fixed IP addresses yourself. Alternatively, you can use your device as a DHCP server. For this internal DHCP server, CAPWAP option 138 is active in order to allow communication between the master and slaves.

If you use static IP addresses in your network, you must enter these to all APs manually. The IP addresses of the wireless LAN controller must be entered for each AP in the **System Management->Global Settings->System** menu in the **Manual WLAN Controller IP Address** field.

Please note: Make sure that option 138 is active when using an external DHCP server.

If you wish to use a bintec elmeg bintec elmeg Gateway for example as a DHCP server, click on the **GUI** menu for this device under **Local Services->DHCP Server->DHCP Pool->New->Advanced Settings** in the **DHCP Options** field on the **Add** button. Select as **Option** *CAPWAP Controller* and in the **Value** field enter the IP address of the WLAN controller.

### IP Address Range

If the IP addresses are to be assigned internally, you must enter the start and end IP address of the desired range.

Please note: If you click on **Next**, a warning appears which informs you that continuing will overwrite the wireless LAN controller configuration. By clicking on **OK** you signal that you agree with this and wish to continue with the configuration.

## 15.1.2 Radio Profile

Select which frequency band your WLAN controller shall use.

If the *2.4 GHz Radio Profile* is set then the 2.4 GHz frequency band is used.

If the *5 GHz Radio Profile* is set then the 5 GHz frequency band is used.

If the corresponding device contains two wireless modules, you can **Use two independent radio profiles**. This assigns *2.4 GHz Radio Profile* to module 1 and *5 GHz Radio Profile* to module 2.

The function is activated by selecting *Enabled*.

The function is disabled by default.

## 15.1.3 Wireless Network

All of the configured wireless networks (VSS) are displayed in the list. At least one wireless network (VSS) is set up. This entry cannot be deleted.

Click on  to edit an existing entry.

You can also delete entries using the  icon.

With **Add**, you can create new entries. You can create up to eight wireless networks (VSS) for a wireless module.



### Note

If you wish to use the default wireless network that is set up, you must at least change the **Preshared Key** parameters. Otherwise you will be prompted.

### 15.1.3.1 Change or add wireless networks

Click on  to edit an existing entry.

With **Add**, you can create new entries.

The following parameters are available

#### **Network Name (SSID)**

Enter the name of the wireless network (SSID).



Enter an ASCII string with a maximum of 32 characters.

Also select whether the **Network Name (SSID)** *Visible* is to be transmitted.

### Security Mode

Select the security mode (encryption and authentication) for the wireless network.

Please note: *WPA Enterprise* means 802.11x.

### WPA Mode

Select for **Security Mode** = *WPA-PSK* or *WPA Enterprise*, whether you wish to use WPA oder WPA 2 or both.

### Preshared Key

Enter the WPA password for **Security Mode** = *WPA-PSK*.

Enter an ASCII string with 8 - 63 characters.



### Important

Change the default Preshared Key! If the key has not been changed, your device will not be protected against unauthorised access!

### Radius Server

You can control access to a wireless network via a RADIUS server.

With **Add**, you can create new entries.

Enter the IP address and the password of the desired RADIUS server.

### EAP Preauthentication

For **Security Mode** = *WPA Enterprise*, select whether the EAP preauthentication function is to be *Enabled*. This function tells your device that WLAN clients, which are already connected to another access point, can first carry out 802.1x authentication as soon as they are within range. Such WLAN clients can then simply connect over the existing network connection with your device.

### VLAN

Select whether the VLAN segmentation is to be used for this wireless network.

If you wish to use VLAN segmentation, enter a value between 2 and 4094 in the input field in order to identify the VLAN. (VLAN ID 1 is not possible!).

**Note**

Before you continue, please ensure that all access points that the WLAN controller shall manage are correctly wired and switched on.

## 15.1.4 Start automatic installation

You will see a list of all detected access points.

If you wish to change the settings of a detected AP, click on  in the corresponding entry.

You will see the settings for all selected access points. You can change these settings.

The following parameters are available in the **Access Point Settings** menu:

### Location

Displays the stated locality of the AP. You can enter another locality.

### Assigned Wireless Network (VSS)

Displays the wireless networks that are currently assigned.

The following parameters are available in the wireless module 1 menu:

(The parts wireless module 1 and wireless module 2 are displayed if the AP has two wireless modules.)

### Operation Mode

Select the mode in which the wireless module is to be operated.

Possible values:

- *On* (default value): The wireless module is used as an access point in your network.
- *OFF*: The wireless module is not active.

### Active Radio Profile

Displays the wireless module profile that is currently selected. You can select another wireless module profile from the list if more than one wireless module profile are being set up.

### Channel

Displays the channel that is assigned. You can select an alternative channel.

The number of channels you can select depends on the country setting. Please consult the data sheet for your device.

**Note**

Configuring the network name (SSID) in Access Point mode means that wireless networks can be logically separated from each other, but they can still physically interfere with each other if they are operating on the same or closely adjacent wireless channels. So if you are operating two or more radio networks close to each other, it is advisable to allocate the networks to different channels. Each of these should be spaced at least four channels apart, as a network also partially occupies the adjacent channels.

In the case of manual channel selection, please make sure first that the APs actually support these channels.

**Transmit Power**

Displays the transmission power in dBm. You can select another transmission power.

With **OK** you apply the settings.

Select the access points that your WLAN controller shall manage. In the **Manage** column, click on the desired entries or click on **Select all** in order to select all entries. Click the **Deselect all** button to disable all entries and to then select individual entries if required (e.g. for large lists).

Click on **Start** in order to install the WLAN and automatically assign the frequencies.

**Note**

If there are not enough licences available, the message "The maximum number of slave access points that can be supported has been exceeded". Please check your licences. If this message is displayed then you should obtain additional licences if appropriate.

During the installation of the WLAN and the allocation of frequencies, on the messages displayed you will see how far the installation has progressed. The display is continuously updated.

Provided that non-overlapping wireless channels are located for all access points, the configuration that is set in the Wizard is transferred to the access points.

When the installation is complete, you will see a list of the **Managed** access points.

Under **Configure the Alert Service for WLAN surveillance**, click **Start** to monitor your managed APs. You are taken to the **External Reporting->Alert Service->Alert Recipient** menu with the default setting **Event** = *Managed AP offline*. You can specify that you wish to be notified by e-mail if the *Managed AP offline* event occurs.

Click under **New Neighborscan** on **Start**, to rescan adjacent AP's. You will receive a warning that the wireless modules of the access points must also be disabled for a certain period of time. When you start the process with **OK**, a progress bar is displayed. The located AP display is updated every ten seconds.

## 15.2 Controller Configuration

In this menu, you make the basic settings for the wireless LAN controller.

### 15.2.1 General

The **Wireless LAN Controller->Controller Configuration->General** menu consists of the following fields:

#### Fields in the **Basic Settings** menu.

Field	Description
<b>Region</b>	<p>Select the country in which the wireless LAN controller is to be operated.</p> <p>Possible values are all the countries configured on the device's wireless module.</p> <p>The range of channels that can be used varies depending on the country setting.</p> <p>The default value is <i>Germany</i>.</p>
<b>Interface</b>	Select the interface to be used for the wireless controller.
<b>DHCP Server</b>	<p>Select whether an external DHCP server shall assign IP addresses to the APs or if you wish to assign fixed IP addresses yourself. Alternatively, you can use your device as a DHCP server. For this internal DHCP server, CAPWAP option 138 is active in order to allow communication between the master and slaves.</p> <p>Please note: Make sure that option 138 is active when using an</p>

Field	Description
	<p>external DHCP server.</p> <p>If you wish to use a bintec elmeg bintec elmeg Gateway for example as a DHCP server, click on the <b>GUI</b> menu for this device under <b>Local Services-&gt;DHCP Server-&gt;DHCP Pool-&gt;New-&gt;Advanced Settings</b> in the <b>DHCP Options</b> field on the <b>Add</b> button. Select as <b>Option</b> <i>CAPWAP Controller</i> and in the <b>Value</b> field enter the IP address of the WLAN controller.</p> <p>If you use static IP addresses in your network, you must enter these to all APs manually. The IP addresses of the wireless LAN controller must be entered for each AP in the <b>System Management-&gt;Global Settings-&gt;System</b> menu in the <b>Manual WLAN Controller IP Address</b> field.</p> <p>Possible values:</p> <ul style="list-style-type: none"> <li>• <i>External or static</i> (default value): An external DHCP server with an CAPWAP option 138 enabled assigns the IP addresses to the APs or you can give static IP addresses to the APs.</li> <li>• <i>Internal</i>: Your device, on which the CAPWAP option 138 is active, assigns the IP addresses to the APs.</li> </ul>
<b>IP Address Range</b>	<p>Only for <b>DHCP Server</b> = <i>Internal</i></p> <p>Enter the start and end IP address of the range. These IP addresses and your device must originate from the same network.</p>
<b>Slave AP location</b>	<p>Select whether the APs that the wireless LAN controller is to manage are located in the LAN or the WAN.</p> <p>Possible values:</p> <ul style="list-style-type: none"> <li>• <i>Local (LAN)</i> (default value)</li> <li>• <i>Remote (WAN)</i></li> </ul> <p>The <i>Remote (WAN)</i> setting is useful if, for example, there is a wireless LAN controller installed at head office and its APs are distributed to different branches. If the APs are linked via VPN, it may be that a connection is terminated. If this happens, the relevant AP with the setting <i>Remote (WAN)</i> maintains its configuration until the connection is reestablished. It then boots up</p>

Field	Description
	and the controller and the AP then resynchronize.
<b>Slave AP LED mode</b>	<p>Select the lighting scheme of the slave AP LEDs.</p> <p>Possible values:</p> <ul style="list-style-type: none"> <li>• <i>State</i> (default value): All LEDs show their standard behavior.</li> <li>• <i>Flashing</i>: Only the status LED flashes once per second.</li> <li>• <i>Off</i>: All LEDs are deactivated.</li> </ul>

## 15.2.2 Slave AP Autoprofile

The Wireless LAN Controller offers the option of automatically including and configuring an access point that is being integrated into the network accessible by the WLAN Controller. In order to be able to automatically assign a configuration to a new access point you have to configure a profile that is valid for all new access points that match certain criteria.

### 15.2.2.1 Edit or New

The **Wireless LAN Controller->Controller Configuration->Slave AP Autoprofile->New** menu consists of the following fields:

#### Fields in the Access Point Filter menu

Field	Description
<b>MAC Address</b>	<p>Enter the MAC address of an access point that is to be configured automatically when it is integrated into the network.</p> <p>By default, <b>All</b> is activated so that the entry matches every new access point.</p>
<b>IP Address / Netmask</b>	<p>Enter an IP address and a netmask. You can enter host as well as network addresses so that you can filter for individual access points as well as for groups of access points from a specific subnet.</p>

#### Fields in the Access Point Settings menu

Field	Description
<b>Location</b>	Specify the location of the AP.
<b>Description</b>	Enter a unique description for the AP.

**Fields in the Radio 1 or in the Radio 2**



Field	Description
<b>Operating Mode</b>	<p>Wählen Sie aus, ob der Betriebsmodus vom verwendeten Funkmodulprofil bestimmt werden soll.</p> <p>The function is activated by selecting <i>Enabled</i>. The function is enabled by default.</p>
<b>Active Radio Profile</b>	<p>Only for <b>Operating Mode</b> = <i>Enabled</i></p> <p>Select a radio profile.</p> <p>Possible values:</p> <ul style="list-style-type: none"> <li>• <i>2.4 GHz Radio Profile</i></li> <li>• <i>5 GHz Radio Profile</i></li> </ul>
<b>Assigned Wireless Network (VSS)</b>	<p>Only for <b>Operating Mode</b> = <i>Enabled</i></p> <p>Add a new radio profile with <b>Add</b>.</p>

## 15.3 Slave AP configuration

In this menu, you will find all of the settings that are required to manage the slave access points.

### 15.3.1 Slave Access Points

In the **Wireless LAN Controller**->**Slave AP configuration**->**Slave Access Points** menu a list of all APs found with the wizard is displayed.

You will see an entry with a parameter set for each access point ( **Location**, **Name**, **IP Address**, **LAN MAC Address**, **Channel**, **Search Channel**, **Status**, **Action**). Choose whether the selected Access Point is to be managed by the WLAN Controller by clicking the  button or the  button in the **Action** column.

You can disconnect the Access Point from the WLAN Controller and therefore remove it from your WLAN infrastructure by click on the  button. The Access Point then receives the *Discovered* status, but is no longer *Managed*.

Click on the **START** button under **Channel reallocation** in order to reassign any assigned

channels, e.g. when a new access point has been added.

#### Possible values for Status

Status	Meaning
<b>Discovered</b>	The AP has registered at the wireless LAN controller. The controller has prompted the required parameters from the AP.
<b>Initialising</b>	The WLAN controller and the APs "communicate" via CAPWAP. The configuration is transferred and enabled to the APs.
<b>Managed</b>	The AP is set to "Managed" status. The controller has sent a configuration to the AP and has enabled this. The AP is managed centrally from the controller and cannot be configured via the <b>GUI</b> .
<b>No License Available</b>	The AP does not have an unassigned licence for this AP.
<b>Offline</b>	The AP is either administratively disabled or switched off or has its power supply cut off etc.

#### 15.3.1.1 Edit

Choose the  icon to edit existing entries.

You can also delete entries using the  icon. If you have deleted APs, these will be located again but shall not be configured.

The data for wireless module 1 and wireless module 2 are displayed in the **Wireless LAN Controller->Slave AP configuration->Slave Access Points->**  menu if the corresponding device has two wireless modules. With devices featuring a single wireless module, the data for wireless module 1 are displayed.

The menu consists of the following fields:

#### Fields in the Access Point Settings menu.

Field	Description
<b>Device</b>	Displays the type of device for the AP.
<b>Location</b>	Displays the locality of the AP. The locations are given numbers if no location has been entered. You can enter another locality.
<b>Name</b>	Displays the name of the AP. You can change the name.
<b>Description</b>	Enter a unique description for the AP.



Field	Description
<b>CAPWAP Encryption</b>	<p>Select whether communication between the master and slaves is to be encrypted.</p> <p>The function is activated by selecting <i>Enabled</i>.</p> <p>The function is enabled by default.</p> <p>You can override the encryption in order to view the communication for debugging purposes.</p>

#### Fields in the **Wireless module1** or in the **Wireless module 2** menu.

Field	Description
<b>Operation Mode</b>	<p>Displays the mode in which the wireless module is to be operated. You can change the mode.</p> <p>Possible values:</p> <ul style="list-style-type: none"> <li>• <i>On</i> (default value): The wireless module is used as an access point in your network.</li> <li>• <i>Off</i>: The wireless module is not active.</li> </ul>
<b>Active Radio Profile</b>	<p>Displays the wireless module profile that is currently selected. You can select another wireless module profile from the list if more than one wireless module profile are being set up.</p>
<b>Channel</b>	<p>Displays the channel that is assigned. You can select another channel.</p> <p>The number of channels you can select depends on the country setting. Please consult the data sheet for your device.</p> <p>Access Point mode</p> <p>Configuring the network name (SSID) in Access Point mode means that wireless networks can be logically separated from each other, but they can still physically interfere with each other if they are operating on the same or closely adjacent wireless channels. So if you are operating two or more radio networks close to each other, it is advisable to allocate the networks to different channels. Each of these should be spaced at least four channels apart, as a network also partially occupies the adjacent channels.</p>

Field	Description
	<p>In the case of manual channel selection, please make sure first that the APs actually support these channels.</p> <p>Possible values (according to the selected wireless module profile):</p> <ul style="list-style-type: none"> <li>• For <b>Active Radio Profile = 2.4 GHz Radio Profile</b> Possible values are <i>1</i> to <i>13</i> and <i>Auto</i> (default value).</li> <li>• For <b>Active Radio Profile = 5 GHz Radio Profile</b> Possible values are <i>36</i>, <i>40</i>, <i>44</i>, <i>48</i> and <i>Auto</i> (default value)</li> </ul>
<b>Used Channel</b>	<p>Only for managed APs.</p> <p>Displays the channel that is currently in use.</p>
<b>Transmit Power</b>	<p>Displays the transmission power. You can select another transmission power.</p> <p>Possible values:</p> <ul style="list-style-type: none"> <li>• <i>Max.</i> (default value): The maximum antenna power is used.</li> <li>• <i>5 dBm</i></li> <li>• <i>8 dBm</i></li> <li>• <i>11 dBm</i></li> <li>• <i>14 dBm</i></li> <li>• <i>16 dBm</i></li> <li>• <i>17 dBm</i></li> </ul>
<b>Assigned Wireless Network (VSS)</b>	<p>Displays the wireless networks that are currently assigned.</p>

### 15.3.2 Radio Profiles

An overview of all created wireless module profiles is displayed in the **Wireless LAN Controller->Slave AP configuration->Radio Profiles** menu. A profile with 2.4 GHz and a profile with 5 GHz are created by default; the 2.4 GHz profile cannot be deleted.

For each wireless module profile you will see an entry with a parameter set (**Radio**

, **Configured Radio Modules, Operation Band, Wireless Mode**).

### 15.3.2.1 Edit or New

Choose the  icon to edit existing entries. Select the **New** button in order to create new wireless module profiles.

The **Wireless LAN Controller->Slave AP configuration->Radio Profiles->**  / **New** menu consists of the following fields:

#### Fields in the menu Radio Profile Definition

Field	Description
<b>Description</b>	Enter the desired description of the wireless module profile.
<b>Operation Mode</b>	<p>Define the mode in which the wireless module profile is to be operated.</p> <p>Possible values:</p> <ul style="list-style-type: none"> <li>• <i>Off</i> (default value): The wireless module profile is not active.</li> <li>• <i>Access Point</i>: Your device is used as an access point in your network.</li> </ul>
<b>Operation Band</b>	<p>Select the frequency band of the wireless module profile.</p> <p>Possible values:</p> <ul style="list-style-type: none"> <li>• <i>2.4 GHz In/Outdoor</i> (default value): Your device is operated at 2.4 GHz inside or outside buildings.</li> <li>• <i>5 GHz Indoor</i>: Your device is operated at 5 GHz inside buildings.</li> <li>• <i>5 GHz Outdoor</i>: Your device is operated at 5 GHz outside buildings.</li> <li>• <i>5 GHz In/Outdoor</i>: Your device is operated at 5 GHz inside or outside buildings.</li> <li>• <i>5.8 GHz Outdoor</i>: Only for so-called Broadband Fixed Wireless Access (BFWA) applications. The frequencies in the frequency range from 5755 MHz to 5875 MHz may only be used in conjunction with commercial offers for public network accesses and requires registration with the Federal Network Agency.</li> </ul>

Field	Description
<b>Bandwidth</b>	<p>Not for <b>Operation Band = 2.4 GHz In/Outdoor</b></p> <p>Select how many channels are to be used.</p> <p>Possible values:</p> <ul style="list-style-type: none"> <li>• <i>20 MHz</i> (default value): One channel with 20 MHz bandwidth is used.</li> <li>• <i>40 MHz</i>: Two channels each with 20 MHz bandwidth are used. In the case one channel acts as a control channel and the other as an expansion channel.</li> <li>• <i>80 MHz</i>: In 802.11 ac mode, a bandwidth of 80 MHz is additionally available.</li> </ul>

#### Fields in the menu Performance Settings

Field	Description
<b>Wireless Mode</b>	<p>Select the wireless technology that the access point is to use.</p> <p>For <b>Operation Band = 2.4 GHz In/Outdoor</b></p> <p>Possible values:</p> <ul style="list-style-type: none"> <li>• <i>802.11g</i>: The device operates only in accordance with 802.11g. 802.11b clients have no access.</li> <li>• <i>802.11b</i>: Your device operates only in accordance with 802.11b and forces all clients to adapt to it.</li> <li>• <i>802.11 mixed (b/g)</i>: Your device adapts to the client technology and operates according to either 802.11b or 802.11g.</li> <li>• <i>802.11 mixed long (b/g)</i>: Your device adapts to the client technology and operates according to either 802.11b or 802.11g. Only a data rate of 1 and 2 mbps needs to be supported by all clients (basic rates). This mode is also needed for Centrino clients if connection problems occur.</li> <li>• <i>802.11 mixed short (b/g)</i>: Your device adapts to the client technology and operates according to either 802.11b or 802.11g. The following applies for mixed-short: The data rates 5.5 and 11 mbps must be supported by all clients (basic rates).</li> <li>• <i>802.11b/g/n</i>: Your device operates according to either 802.11b, 802.11g or 802.11n.</li> </ul>

Field	Description
	<ul style="list-style-type: none"> <li>• <i>802.11g/n</i>: Your device operates according to either 802.11g or 802.11n.</li> <li>• <i>802.11n</i>: Your device operates only according to 802.11n.</li> </ul> <p><b>For Operation Band = 5 GHz Indoor, 5 GHz Outdoor, 5 GHz In/Outdoor or 5.8 GHz Outdoor</b></p> <p>Possible values:</p> <ul style="list-style-type: none"> <li>• <i>802.11a</i>: The device operates only in accordance with 802.11a.</li> <li>• <i>802.11n</i>: Your device operates only according to 802.11n.</li> <li>• <i>802.11a/n</i>: Your device operates according to either 802.11a or 802.11n.</li> <li>• <i>802.11a/n</i>: Your device operates according to 802.11ac, 802.11a or 802.11n.</li> <li>• <i>802.11a/n</i>: Your device operates according to either 802.11ac or 802.11n.</li> </ul>
<b>Number of Spatial Streams</b>	<p>Select how many traffic flows are to be used in parallel.</p> <p>Possible values:</p> <ul style="list-style-type: none"> <li>• 3: Three traffic flows are used.</li> <li>• 2: Two traffic flows are used.</li> <li>• 1: One traffic flow is used.</li> </ul>
<b>Max. Transmission Rate</b>	<p>Select the transmission speed.</p> <p>Possible values:</p> <ul style="list-style-type: none"> <li>• <i>Auto</i> (default value): The transmission speed is determined automatically.</li> <li>• <i>&lt;Value&gt;</i>: According to setting for <b>Operation Band, Bandwidth, Number of Spatial Streams</b> and <b>Wireless Mode</b> various fixed values in mbps are available.</li> </ul>
<b>Airtime fairness</b>	<p>This function is not available for all devices.</p> <p>The <b>Airtime fairness</b> function ensures that the access point's send resources are distributed intelligently to the connected clients. This means that a powerful client (e. g. a 802.11n client) cannot achieve only a poor flow level, because a less powerful</p>

Field	Description
	<p>client (e. g. a 802.11a client) is treated in the same way when apportioning.</p> <p>The function is enabled with <i>Enabled</i>.</p> <p>The function is disabled by default.</p> <p>This function is only applied to unprioritized frames of the WMM Classe "Background".</p>
<b>Cyclic Background Scanning</b>	<p>Not all devices support this function.</p> <p>You can enable the <b>Cyclic Background Scanning</b> function so that a search is run at regular intervals for neighbouring or rogue access points in the network. This search is run without negatively impacting the function as an access point.</p> <p>Enable or disable the function <b>Cyclic Background Scanning</b>.</p> <p>The function is enabled with <i>Enabled</i>.</p> <p>The function is not activated by default.</p>

The menu **Advanced Settings** consists of the following fields:

#### Fields in the menu **Advanced Settings**

Field	Description
<b>Channel Plan</b>	<p>Select the desired channel plan.</p> <p>The channel plan makes a preselection when a channel is selected. This ensures that no channels overlap, i.e. a distance of four channels is maintained between the channels used. This is useful if more access points are used with overlapping radio cells.</p> <p>Possible values:</p> <ul style="list-style-type: none"> <li>• <i>All</i>: All channels can be dialled when a channel is selected.</li> <li>• <i>Auto</i>: Depending on the region, operation band, wireless mode and bandwidth, the channels that have a distance of 4 channels are provided.</li> <li>• <i>User defined</i>: You can select the desired channels yourself.</li> </ul>

Field	Description
<b>User Defined Channel Plan</b>	<p>Only for <b>Channel Plan</b> = <i>User defined</i></p> <p>The currently selected channels are displayed here.</p> <p>With <b>Add</b> you can add channels. If all available channels are displayed, you cannot add any more entries.</p> <p>You can also delete entries using the  icon.</p>
<b>Beacon Period</b>	<p>Enter the time in milliseconds between the sending of two beacons.</p> <p>This value is transmitted in Beacon and Probe Response Frames.</p> <p>Possible values are <i>1</i> to <i>65535</i>.</p> <p>The default value is <i>100</i>.</p>
<b>DTIM Period</b>	<p>Enter the interval for the Delivery Traffic Indication Message (DTIM).</p> <p>The DTIM field is a data field in transmitted beacons that informs clients about the window to the next broadcast or multicast transmission. If clients operate in power save mode, they come alive at the right time and receive the data.</p> <p>Possible values are <i>1</i> to <i>255</i>.</p> <p>The default value is <i>2</i>.</p>
<b>RTS Threshold</b>	<p>Here you can specify the data packet length threshold in bytes (1..2346) as of which the RTS/CTS mechanism is to be used. This makes sense if several clients that are not in each other's wireless range are run in one access point.</p>
<b>Short Guard Interval</b>	<p>Enable this function to reduce the guard interval (= time between transmission of two data symbols) from 800 ns to 400 ns.</p>
<b>Max. Transmission Rate</b>	<p>Select the transmission speed.</p> <p>Possible values:</p> <ul style="list-style-type: none"> <li>• <i>Auto</i> (default value): The transmission speed is determined</li> </ul>

Field	Description
	<p>automatically.</p> <ul style="list-style-type: none"> <li>• <i>&lt;Value&gt;</i>: According to setting for <b>Operation Band</b>, <b>Bandwidth</b>, <b>Number of Spatial Streams</b> and <b>Wireless Mode</b> various fixed values in mbps are available.</li> </ul>
<b>Short Retry Limit</b>	<p>Enter the maximum number of attempts to send a frame with length less than or equal to the value defined in <b>RTS Threshold</b>. After this many failed attempts, the packet is discarded.</p> <p>Possible values are <i>1</i> to <i>255</i>.</p> <p>The default value is <i>7</i>.</p>
<b>Long Retry Limit</b>	<p>Enter the maximum number of attempts to send a data packet of length greater than the value defined in <b>RTS Threshold</b>. After this many failed attempts, the packet is discarded.</p> <p>Possible values are <i>1</i> to <i>255</i>.</p> <p>The default value is <i>4</i>.</p>
<b>Fragmentation Threshold</b>	<p>Enter the maximum size as of which the data packets are to be fragmented (i.e. split into smaller units). Low values are recommended for this field in areas with poor reception and in the event of radio interference.</p> <p>Possible values are <i>256</i> to <i>2346</i>.</p> <p>The default value is <i>2346</i>.</p>

### 15.3.3 Wireless Networks (VSS)

An overview of all created wireless networks is displayed in the **Wireless LAN Controller->Slave AP configuration->Wireless Networks (VSS)** menu. A wireless network is created by default.

For every wireless network (VSS), you see an entry with a parameter set (**VSS Description**, **Network Name (SSID)**, **Number of associated radio modules**, **Security**, **Status**, **Action**).

Under **Assign unassigned VSS to all radio modules** click on the **Start** button to assign a newly-created VSS to all wireless modules.



### 15.3.3.1 Edit or New

Choose the  icon to edit existing entries. Choose the **New** button to configure additional wireless networks.

The **Wireless LAN Controller->Slave AP configuration->Wireless Networks (VSS)->New** menu consists of the following fields:

#### Fields in the menu **Service Set Parameters**

Field	Description
<b>Network Name (SSID)</b>	<p>Enter the name of the wireless network (SSID).</p> <p>Enter an ASCII string with a maximum of 32 characters.</p> <p>Also select whether the <b>Network Name (SSID)</b> is to be transmitted.</p> <p>The network name is displayed by selecting <i>Visible</i>.</p> <p>It is visible by default.</p>
<b>Intra-cell Repeating</b>	<p>Select whether communication between the WLAN clients is to be permitted within a radio cell.</p> <p>The function is activated by selecting <i>Enabled</i>.</p> <p>The function is enabled by default.</p>
<b>ARP Processing</b>	<p>Select whether the ARP processing function should be enabled. The ARP data traffic is reduced in the network by the fact that ARP broadcasts that have been converted to ARP unicasts are forwarded to IP addresses that are known internally. Unicasts are quicker and clients with an enabled power save function are not addressed.</p> <p>The function is activated by selecting <i>Enabled</i>.</p> <p>The function is disabled by default.</p> <p>Make sure that ARP processing cannot be applied together with the MAC bridge function.</p>
<b>WMM</b>	<p>Select whether voice or video prioritisation via WMM (Wireless Multimedia) is to be activated for the wireless network so that</p>

Field	Description
	<p>optimum transmission quality is always achieved for time-critical applications. Data prioritisation is supported in accordance with DSCP (Differentiated Services Code Point) or IEEE802.1d.</p> <p>The function is activated by selecting <i>Enabled</i>.</p> <p>The function is enabled by default.</p>
<b>IGMP Snooping</b>	<p>IGMP snooping reduces the data traffic and thus the network load, as Multicast packets from the LAN are not forwarded. Only those Multicast packets will be forwarded that are requested by the respective clients. When you enable IGMP snooping, IGMP snooping, therefore, provides the framework in which Multicast is applied.</p> <p>The function is activated by selecting <i>Enabled</i>.</p> <p>The function is disabled by default.</p>

#### Fields in the menu **Security Settings**

Field	Description
<b>Security Mode</b>	<p>Select the security mode (encryption and authentication) for the wireless network.</p> <p>Possible values:</p> <ul style="list-style-type: none"> <li>• <i>Inactive</i> (default value): Neither encryption nor authentication</li> <li>• <i>WEP 40</i>: WEP 40 bits</li> <li>• <i>WEP 104</i>: WEP 104 bits</li> <li>• <i>WPA-PSK</i>: WPA Preshared Key</li> <li>• <i>WPA Enterprise</i>: 802.11x</li> </ul>
<b>Transmit Key</b>	<p>Only for <b>Security Mode</b> = <i>WEP 40</i> or <i>WEP 104</i></p> <p>Select one of the keys configured in <b>WEP Key</b> as a standard key.</p> <p>The default value is <i>Key 1</i>.</p>
<b>WEP Key 1-4</b>	<p>Only for <b>Security Mode</b> = <i>WEP 40</i>, <i>WEP 104</i></p> <p>Enter the WEP key.</p>

Field	Description
	<p>Enter a character string with the right number of characters for the selected WEP mode. For <i>WEP 40</i> you need a character string with 5 characters, for <i>WEP 104</i> with 13 characters, e. g. <i>hello</i> for <i>WEP 40</i>, <i>wep1</i> for <i>WEP 104</i>.</p>
<b>WPA Mode</b>	<p>Only for <b>Security Mode</b> = <i>WPA-PSK</i> and <i>WPA Enterprise</i></p> <p>Select whether you want to use WPA (with TKIP encryption) or WPA 2 (with AES encryption), or both.</p> <p>Possible values:</p> <ul style="list-style-type: none"> <li>• <i>WPA and WPA 2</i> (default value): WPA and WPA 2 can be used.</li> <li>• <i>WPA</i>: Only WPA is used.</li> <li>• <i>WPA 2</i>: Only WPA2 is used.</li> </ul>
<b>WPA Cipher</b>	<p>Only for <b>Security Mode</b> = <i>WPA-PSK</i> and <i>WPA Enterprise</i> and for <b>WPA Mode</b> = <i>WPA</i> and <i>WPA and WPA 2</i></p> <p>Select the type of encryption you want to apply to WPA.</p> <p>Possible values:</p> <ul style="list-style-type: none"> <li>• <i>TKIP</i> (default value): TKIP is used.</li> <li>• <i>AES</i>: AES is used.</li> <li>• <i>AES and TKIP</i>: AES or TKIP is used.</li> </ul>
<b>WPA2 Cipher</b>	<p>Only for <b>Security Mode</b> = <i>WPA-PSK</i> and <i>WPA Enterprise</i> and for <b>WPA Mode</b> = <i>WPA 2</i> and <i>WPA and WPA 2</i></p> <p>Select the type of encryption you want to apply to WPA2.</p> <p>Possible values:</p> <ul style="list-style-type: none"> <li>• <i>AES</i> (default value): AES is used.</li> <li>• <i>TKIP</i>: TKIP is used.</li> <li>• <i>AES and TKIP</i>: AES or TKIP is used.</li> </ul>
<b>Preshared Key</b>	<p>Only for <b>Security Mode</b> = <i>WPA-PSK</i></p> <p>Enter the WPA password.</p>

Field	Description
	<p>Enter an ASCII string with 8 - 63 characters.</p> <p>Note: Change the default Preshared Key! If the key has not been changed, your device will not be protected against unauthorised access!</p>
<b>Radius Server</b>	<p>You can control access to a wireless network via a RADIUS server.</p> <p>With <b>Add</b>, you can create new entries. Enter the IP address and the password of the RADIUS server.</p>
<b>EAP Preauthentication</b>	<p>Only for <b>Security Mode</b> = <i>WPA Enterprise</i></p> <p>Select whether the EAP preauthentication function is to be activated. This function tells your device that WLAN clients, which are already connected to another access point, can first carry out 802.1x authentication as soon as they are within range. Such WLAN clients can then simply connect over the existing network connection with your device.</p> <p>The function is activated by selecting <i>Enabled</i>.</p> <p>The function is enabled by default.</p>

#### Fields in the menu Client load balancing

Field	Description
<b>Max. number of clients - hard limit</b>	<p>Enter the maximum number of clients that can be connected to this wireless network (SSID)</p> <p>The maximum number of clients that can register with a wireless module depends on the specifications of the respective WLAN module. This maximum is distributed across all wireless networks configured for this radio module. No more new wireless networks can be created and a warning message will appear if the maximum number of clients is reached.</p> <p>Possible values are whole numbers between <i>1</i> and <i>254</i>.</p> <p>The default value is <i>32</i>.</p>
<b>Max. number of clients - soft limit</b>	<p>Not all devices support this function.</p>

Field	Description
	<p>To avoid a radio module being fully utilised, you can set a "soft" restriction on the number of connected clients. If this number is reached, new connection queries are initially rejected. If the client cannot find another wireless network and, therefore, repeats its query, the connection is accepted. Queries are only definitively rejected when the <b>Max. number of clients - hard limit</b> is reached.</p> <p>The value of the <b>Max. number of clients - soft limit</b> must be the same as or less than that of the <b>Max. number of clients - hard limit</b>.</p> <p>The default value is <i>28</i>.</p> <p>You can disable this function if you set <b>Max. number of clients - soft limit</b> and <b>Max. number of clients - hard limit</b> to identical values.</p>
<b>Client Band select</b>	<p>Not all devices support this function.</p> <p>This function requires a dual radio setup where the same wireless network is configured on both radio modules, but in different frequency bands.</p> <p>The <b>Client Band select</b> option enables clients to be moved from the frequency band originally selected to a less busy one, providing the client supports this. To achieve a changeover, the connection attempt of a client is initially refused so that the client repeats the attempt in a different frequency band.</p> <p>Possible values:</p> <ul style="list-style-type: none"> <li>• <i>Disabled - optimized for fast roaming</i> (default value): The function is not used for this VSS. This is useful if clients are to switch between different radio cells with as little delay as possible, e. g. with Voice over WLAN.</li> <li>• <i>2,4 GHz band preferred</i>: Preference is given to accepting clients in the 2.4 GHz band.</li> <li>• <i>5 GHz band preferred</i>: Preference is given to accepting clients in the 5 GHz band.</li> </ul>

#### Fields in the menu **MAC-Filter**

Field	Description
<b>Access Control</b>	<p>Select whether only certain clients are to be permitted for this wireless network.</p> <p>The function is activated by selecting <i>Enabled</i>.</p> <p>The function is disabled by default.</p>
<b>Allowed Addresses</b>	<p>Use <b>Add</b> to make entries and enter the MAC addresses (<b>MAC Address</b>) of the clients to be permitted.</p>
<b>Dynamic blacklisting</b>	<p>You can use the <b>Dynamic blacklisting</b> function to identify clients that want to gain possibly unauthorised access to the network and block them for a certain length of time. A client is blocked if the number of unsuccessful login attempts with a specified time exceeds a certain number. This threshold value and the duration of the block can be configured. A blocked client is blocked at all the APs that are managed by the wireless LAN controller for the VSS concerned, so neither are they able to log into a different radio cell in that VSS. If a client needs to be blocked permanently, this can be done in the <b>Wireless LAN Controller-&gt;Monitoring-&gt;Rogue Clients</b> menu.</p> <p>The function is activated by selecting <i>Enabled</i>.</p> <p>The function is activated by default.</p>
<b>Failed attempts per Time</b>	<p>Enter the number of failed attempts that have to originate from a specific MAC address during a certain time for a blacklist entry to be created.</p> <p>Default values are <i>10</i> failed attempts during <i>60</i> seconds.</p>
<b>Blacklist blocktime</b>	<p>Enter the time for which an entry in the dynamic blacklist remains valid.</p> <p>Default value is <i>500</i> seconds.</p>

#### Fields in the menu VLAN

Field	Description
<b>VLAN</b>	<p>Select whether the VLAN segmentation is to be used for this wireless network.</p> <p>The function is activated by selecting <i>Enabled</i>.</p>

Field	Description
	The function is disabled by default.
<b>VLAN ID</b>	Enter the number that identifies the VLAN.  Possible values are 2 to 4094.  VLAN ID 1 is not possible as it is already in use.

#### Fields in the menu **Bandwidth limitation for each WLAN client**

Field	Description
<b>Rx Shaping</b>	Select a bandwidth limitation in the receive direction.  Possible values are <ul style="list-style-type: none"> <li>• <i>No limit</i> (default value)</li> <li>• <i>0,25 Mbit/s, 0,5 Mbit/s, 1 Mbit/s up to 10 Mbit/s in single Mbit/s steps, 15 Mbit/s, 20 Mbit/s, 30 Mbit/s, 40 Mbit/s and 50 Mbit/s.</i></li> </ul>
<b>Tx Shaping</b>	Select a bandwidth limitation in the transmit direction.  Possible values are <ul style="list-style-type: none"> <li>• <i>No limit</i> (default value)</li> <li>• <i>0,25 Mbit/s, 0,5 Mbit/s, 1 Mbit/s up to 10 Mbit/s in single Mbit/s steps, 15 Mbit/s, 20 Mbit/s, 30 Mbit/s, 40 Mbit/s and 50 Mbit/s.</i></li> </ul>

## 15.4 Monitoring

This menu is used to monitor your WLAN infrastructure.



### Note

In order to ensure adequate timing between the WLAN Controller and the connected Slave APs, the internal time server of the WLAN Controller should be enabled.

### 15.4.1 WLAN Controller

In the **Wireless LAN Controller->Monitoring->WLAN Controller** menu, an overview of

the most relevant Wireless LAN Controller parameters is displayed. The display is refreshed every 30 seconds.

#### Values in the Overview list

Status	Meaning
<b>AP discovered</b>	Displays the number of discovered access points.
<b>AP offline</b>	Displays the number of access points not connected to the Wireless LAN Controller.
<b>AP managed</b>	Displays the number of managed access points.
<b>WLAN Controller: VSS throughput</b>	Displays the data traffic in receive and transmit direction in bytes per second.
<b>CPU usage [%]</b>	Displays the percentaged CPU load over time.
<b>Memory usage [%]</b>	Displays the percentaged memory consumption over time.
<b>Connected clients/VSS</b>	Displays the number of connected clients per wireless network (VSS) over time.

## 15.4.2 Slave Access Points

The menu **Wireless LAN Controller->Monitoring->Slave Access Points** shows a survey of all detected access points. Each access point is displayed along with the following parameters: **Location, Name, IP Address, LAN MAC Address, Channel, Tx Bytes** and **Rx Bytes**. Moreover, you can see if an access point is in *Managed* or *Discovered* state.

Via the  icon, you can open an summary with additional details about the **Slave Access Points**.

### 15.4.2.1 Overview

In the **Overview** menu, additional information about the selected access point is displayed. The display is refreshed every 30 seconds.

#### Values in the Overview list

Status	Meaning
<b>Throughput</b>	Displays the received and transmitted data traffic per radio module over time.
<b>Connected clients</b>	Displays the number of connected clients per radio module over time.



### 15.4.2.2 Radio 1

In the **Radio Module** menu, the received and transmitted data traffic per client is displayed over time. Each graph in the display is distinctly assigned to a client by its color and MAC address.

#### Values in the Radio list

Status	Meaning
Throughput/client	Displays the received and transmitted data traffic per client over time.

### 15.4.3 Active Clients

In the **Wireless LAN Controller->Monitoring->Active Clients** menu, current values of all active clients are displayed.

For each client you will see an entry with the following parameter set: **Location, Slave AP Name, VSS, Client MAC, Client IP Address, Signal : Noise (dBm) , Tx Bytes, Rx Bytes, Tx Discards, Rx Discards, Status, Uptime.**

#### Possible values for Status

Status	Meaning
None	The client is no longer in a valid status.
Logon	The client is currently logging on with the WLAN.
Associated	The client is logged on with the WLAN.
Authenticate	The client is in the process of being authenticated.
Authenticated	The client is authenticated.

Via the  icon, you can open a summary with additional details about the **Active Clients**.

#### Value in the list WLAN Client list

Status	Meaning
Throughput	Displays the data traffic - separated into received and transmitted traffic - for the selected WLAN client over time.
Signal	Displays the signal strength of the selected WLAN client over time.

## 15.4.4 Wireless Networks (VSS)

In the **Wireless LAN Controller->Monitoring->Wireless Networks (VSS)** menu, an overview of the currently used AP is displayed. You see which wireless module is assigned to which wireless network. For each wireless a parameter set is displayed (**Location, Slave AP Name, VSS, MAC Address (VSS), Channel, Status**).

## 15.4.5 Client Management

The **Wireless LAN Controller->Monitoring->Client Management** menu displays information on the client management by the access points. You can, e.g., see the number of connected clients, the number of clients that are affected by the **2,4/5 GHz changeover** and the number of rejected clients.

You can delete the values of an entry using the  symbol.

## 15.5 Neighbor Monitoring

This menu serves the monitoring of remote access points.

### 15.5.1 Neighbor APs

In the **Wireless LAN Controller->Neighbor Monitoring->Neighbor APs** menu, the adjacent AP's found during the scan are displayed. **Rogue APs**, i.e. APs which are not managed by the WLAN controller but are using an SSID managed by the WLAN controller are highlighted in red.



#### Note

Check the rogue APs shown carefully, as an attacker could attempt to spy on data in your network using a rogue AP.

Although each AP is found more than once, it is only displayed once with the strongest signal. You see the following parameters for each AP: **SSID, MAC Address, Signal dBm, Channel, Security, Last seen, Strongest signal received by, Total detections**.

The entries are displayed in alphabetical order by **SSID**. **Security** shows the security settings of the AP. Under **Strongest signal received by**, you will see the parameters **Location** and **Name** of the APs in which the displayed AP was found. **Total detections** shows

how often the corresponding AP was found during the scan.

Click under **New Neighborscan** on **Start**, to rescan adjacent AP's. You will receive a warning that the wireless modules of the access points must also be disabled for a certain period of time. When you start the process with **OK**, a progress bar is displayed. The located AP display is updated every ten seconds.

## 15.5.2 Rogue APs

APs which are using an SSID from their own network but are not managed by **Wireless LAN Controller** are displayed in the **Wireless LAN Controller->Neighbor Monitoring->Rogue APs** menu. **Rogue APs** which have been found for the first time are displayed with a red background.

For each rogue AP you will see an entry with the following parameter set: **SSID, MAC Address, Signal dBm, Channel, Last seen, Detected via AP, Accepted**.



### Note

Check the rogue APs shown carefully, as an attacker could attempt to spy on data in your network using a rogue AP.

You can class a rogue AP as trustworthy by enabling the **Accepted** checkbox. If an alarm has been configured, this is then removed and no longer sent. The red background disappears.

Click under **New Neighborscan** on **Start**, to rescan adjacent AP's. You will receive a warning that the wireless modules of the access points must also be disabled for a certain period of time. When you start the process with **OK**, a progress bar is displayed. The located AP display is updated every ten seconds.

## 15.5.3 Rogue Clients

The **Wireless LAN Controller->Neighbor Monitoring->Rogue Clients** menu displays the clients which have attempted to gain unauthorised access to the network and which are therefore on the blacklist. The blacklist is configured for each VSS in the **Wireless LAN Controller->Slave AP configuration->Wireless Networks (VSS)** menu. You can also add a new entry to the static blacklist.

**Possible values for Rogue Clients**

Status	Meaning
<b>Rogue Client MAC Address</b>	Displays the MAC address of the client on the blacklist.
<b>Network Name (SSID)</b>	Displays the SSID involved.
<b>Attacked Access Point</b>	Displays the AP concerned.
<b>Signal dBm</b>	Displays the signal strength of the client during the attempted access.
<b>Type of attack</b>	This displays the type of potential attack, e. g. an incorrect authentication.
<b>First seen</b>	Displays the time of the first registered attempted access.
<b>Last seen</b>	Displays the time of the last registered attempted access.
<b>Static Blacklist</b>	You can categorise a rogue client as untrustworthy by selecting the checkbox in the <b>Static Blacklist</b> column. The block on the client does not then end automatically, rather you need to lift it manually.
<b>Delete</b>	You can delete entries with the  symbol.

### 15.5.3.1 New

Choose the **New** button to configure additional blacklist entries.

The menu consists of the following fields:

#### Fields in the New Blacklist Entry menu

Field	Description
<b>Rogue Client MAC Address</b>	Enter the MAC address of the client you intend to include in the static blacklist.
<b>Network Name (SSID)</b>	Pick the wireless network you want to exclude the rogue client from.

## 15.6 Maintenance

This menu is used for the maintenance of your managed APs.

### 15.6.1 Firmware Maintenance

In the **Wireless LAN Controller->Maintenance->Firmware Maintenance** menu, a list of all **Managed Access Points** is displayed.

For each managed AP you will see an entry with the following parameter set: **Update firmware, Location, Device, IP Address, LAN MAC Address, Firmware Version, Status**.

Click the **Select all** button to select all of the entries for a firmware update. Click the **Deselect all** button to disable all entries and to then select individual entries if required (e.g. if there is a large number of entries and only individual APs are to be given software updates).

#### Possible values for Status

Status	Meaning
<b>Image already exists.</b>	The software image already exists; no update is required.
<b>Error</b>	An error has occurred.
<b>Running</b>	The operation is currently in progress.
<b>Done</b>	The update is complete.

The **Wireless LAN Controller->Maintenance->Firmware Maintenance** menu consists of the following fields:

#### Fields in the Firmware Maintenance menu

Field	Description
<b>Action</b>	<p>Select the action you wish to execute.</p> <p>After each task, a window is displayed showing the other steps that are required.</p> <p>Possible values:</p> <ul style="list-style-type: none"> <li>• <i>Update system software</i>: You can also start an update of the system software.</li> <li>• <i>Save configuration with state information</i>: You can save a configuration which contains the AP status information.</li> </ul>
<b>Source Location</b>	<p>Select the source for the action.</p> <p>Possible values:</p> <ul style="list-style-type: none"> <li>• <i>HTTP server</i> (default value): The file is stored respectively on a remote server specified in the <b>URL</b>.</li> <li>• <i>Current Software from Update Server</i>: The file is on</li> </ul>

Field	Description
	<p>the official update server. (Only for <b>Action</b>= <i>Update system software</i>)</p> <ul style="list-style-type: none"><li>• <i>TFTP server</i>: The file is stored respectively on a TFTP server specified in the <b>URL</b>.</li></ul>
<b>URL</b>	<p>Only for <b>Source Location</b> = <i>HTTP server</i> or <i>TFTP server</i> Enter the URL of the update server from which the system software file is loaded or on which the configuration file is saved.</p>

## Chapter 16 Networking

### 16.1 Routes

#### Default Route

With a default route, all data is automatically forwarded to one connection if no other suitable route is available. If you set up access to the Internet, you must configure the route to your Internet Service Provider (ISP) as a default route. If, for example, you configure a corporate network connection, only enter the route to the head office or branch office as a default route if you do not configure Internet access over your device. If, for example, you configure both Internet access and a corporate network connection, enter a default route to the ISP and a network route to the head office. You can enter several default routes on your device, but only one default route can be active at any one time. If you enter several default routes, you should thus note differing values for **Metric**.

#### 16.1.1 IPv4 Route Configuration

A list of all configured routes is displayed in the **Network->Routes->IPv4 Route Configuration** menu.

In the ex works state, a predefined entry with the parameters **Destination IP Address** = `192.168.0.0`, **Netmask** = `255.255.255.0`, **Gateway** = `192.168.0.250`, **Interface** = `LAN_EN1-0`, **Route Type** = `Network Route via Interface` is displayed.

##### 16.1.1.1 Edit or New

Choose the  icon to edit existing entries. Choose the **New** button to create additional routes.

If the *Extended* option is selected for the **Route Class**, an extra configuration section opens.

The **Network->Routes->IPv4 Route Configuration->New** menu consists of the following fields:

**Fields in the menu Basic Parameters**

Field	Description
Route Type	<p>Select the type of route.</p> <p>Possible values:</p> <ul style="list-style-type: none"> <li>• <i>Default Route via Interface</i>: Route via a specific interface which is to be used if no other suitable route is available.</li> <li>• <i>Default Route via Gateway</i>: Route via a specific gateway which is to be used if no other suitable route is available.</li> <li>• <i>Host Route via Interface</i>: Route to an individual host via a specific interface.</li> <li>• <i>Host Route via Gateway</i>: Route to an individual host via a specific gateway.</li> <li>• <i>Network Route via Interface</i> (default value): Route to a network via a specific interface.</li> <li>• <i>Network Route via Gateway</i>: Route to a network via a specific gateway.</li> </ul> <p>Only for interfaces that are operated in DHCP client mode:</p> <p>Even if an interface is configured for DHCP client mode, routes can still be configured for data traffic via that interface. The settings received from the DHCP server are then copied, along with those configured here, to the active routing table. This enables, e. g., in the case of dynamically changing gateway addresses, particular routes to be maintained, or routes with different metrics (i. e. of differing priority) to be specified. However, if the DHCP server sends static routes, the settings configured here are not copied to the routing.</p> <ul style="list-style-type: none"> <li>• <i>Default Route Template per DHCP</i>: The information of the gateway to be used is received via DHCP and integrated into the route.</li> <li>• <i>Host Route Template per DHCP</i>: The settings received by DHCP are supplemented by routing information about a particular host.</li> <li>• <i>Network Route Template per DHCP</i>: The settings received by DHCP are supplemented by routing information about a particular network.</li> </ul>



Field	Description
	<div style="border: 1px solid gray; padding: 5px;">  <p><b>Note</b></p> <p>When the DHCP lease expires or when the device is restarted, the routes that consist from the combination of DHCP settings and those made here are initially deleted once more from the active routing. If the DHCP is reconfigured they are re-generated and re-activated.</p> </div>
<b>Interface</b>	Select the interface to be used for this route.
<b>Route Class</b>	<p>Select the type of <b>Route Class</b>.</p> <p>Possible values:</p> <ul style="list-style-type: none"> <li>• <i>Standard</i> (default value): Defines a route with the default parameters.</li> <li>• <i>Extended</i>: Select whether the route is to be defined with extended parameters. If the function is active, a route is created with extended routing parameters such as source interface and source IP address, as well as protocol, source and destination port, type of service (TOS) and the status of the device interface.</li> </ul>

#### Fields in the menu **Route Parameters**

Field	Description
<b>Local IP Address</b>	<p>Only for <b>Route Type</b> = <i>Default Route via Interface</i>, <i>Host Route via Interface</i> or <i>Network Route via Interface</i></p> <p>Enter the own IP address of the router on the selected interface.</p>
<b>Destination IP Address/Netmask</b>	<p>Only for <b>Route Type</b> <i>Host Route via Interface</i> or <i>Network Route via Interface</i></p> <p>Enter the IP address of the destination host or destination network.</p> <p>When <b>Route Type</b> = <i>Network Route via Interface</i></p> <p>Also enter the relevant netmask in the second field.</p>

Field	Description
<b>Gateway IP Address</b>	<p>Only for <b>Route Type</b> = <i>Default Route via Gateway, Host Route via Gateway</i> or <i>Network Route via Gateway</i></p> <p>Enter the IP address of the gateway to which your device is to forward the IP packets.</p>
<b>Metric</b>	<p>Select the priority of the route.</p> <p>The lower the value, the higher the priority of the route.</p> <p>Value range from 0 to 15. The default value is 1.</p>

#### Fields in the menu **Extended Route Parameters**

Field	Description
<b>Description</b>	Enter a description for the IP route.
<b>Source Interface</b>	<p>Select the interface over which the data packets are to reach the device.</p> <p>The default value is <i>None</i>.</p>
<b>Source IP Address/ Netmask</b>	Enter the IP address and netmask of the source host or source network.
<b>Layer 4 Protocol</b>	<p>Select a protocol.</p> <p>Possible values: <i>AH, Any, ESP, GRE, ICMP, IGMP, L2TP, OSPF, PIM, TCP, UDP</i>.</p> <p>The default value is <i>Any</i>.</p>
<b>Source Port</b>	<p>Only for <b>Layer 4 Protocol</b> = <i>TCP</i> or <i>UDP</i></p> <p>Enter the source port.</p> <p>First select the port number range.</p> <p>Possible values:</p> <ul style="list-style-type: none"> <li>• <i>Any</i> (default value): The route is valid for all port numbers.</li> <li>• <i>Single</i>: Enables the entry of a port number.</li> </ul>

Field	Description
	<ul style="list-style-type: none"> <li>• <i>Range</i>: Enables the entry of a range of port numbers.</li> <li>• <i>Privileged</i>: Entry of privileged port numbers: 0 ... 1023.</li> <li>• <i>Server</i>: Entry of server port numbers: 5000 ... 32767.</li> <li>• <i>Clients 1</i>: Entry of client port numbers: 1024 ... 4999.</li> <li>• <i>Clients 2</i>: Entry of client port numbers: 32768 ... 65535.</li> <li>• <i>Not privileged</i>: Entry of unprivileged port numbers: 1024 ... 65535.</li> </ul> <p>Enter the appropriate values for the individual port or start port of a range in <b>Port</b> and, for a range, the end port in <b>to Port</b>.</p>
<b>Destination Port</b>	<p>Only for <b>Layer 4 Protocol</b> = <i>TCP</i> or <i>UDP</i></p> <p>Enter the destination port.</p> <p>First select the port number range.</p> <p>Possible values:</p> <ul style="list-style-type: none"> <li>• <i>Any</i> (default value): The route is valid for all port numbers.</li> <li>• <i>Single</i>: Enables the entry of a port number.</li> <li>• <i>Range</i>: Enables the entry of a range of port numbers.</li> <li>• <i>Privileged</i>: Entry of privileged port numbers: 0 ... 1023.</li> <li>• <i>Server</i>: Entry of server port numbers: 5000 ... 32767.</li> <li>• <i>Clients 1</i>: Entry of client port numbers: 1024 ... 4999.</li> <li>• <i>Clients 2</i>: Entry of client port numbers: 32768 ... 65535.</li> <li>• <i>Not privileged</i>: Entry of unprivileged port numbers: 1024 ... 65535.</li> </ul> <p>Enter the appropriate values for the individual port or start port of a range in <b>Port</b> and, for a range, the end port in <b>to Port</b>.</p>
<b>DSCP / TOS Value</b>	<p>Select the Type of Service (TOS).</p> <p>Possible values:</p> <ul style="list-style-type: none"> <li>• <i>Ignore</i> (default value): The type of service is ignored.</li> <li>• <i>DSCP Binary Value</i>: Differentiated Services Code Point according to RFC 3260 is used to signal the priority of IP packets (indicated in binary format).</li> <li>• <i>DSCP Decimal Value</i>: Differentiated Services Code Point</li> </ul>

Field	Description
	<p>according to RFC 3260 is used to signal the priority of IP packets (indicated in decimal format).</p> <ul style="list-style-type: none"> <li>• <i>DSCP Hexadecimal Value</i>: Differentiated Services Code Point according to RFC 3260 is used to signal the priority of IP packets (indicated in hexadecimal format).</li> <li>• <i>TOS Binary Value</i>: The TOS value is specified in binary format, e.g. 00111111.</li> <li>• <i>TOS Decimal Value</i>: The TOS value is specified in decimal format, e.g. 63.</li> <li>• <i>TOS Hexadecimal Value</i>: The TOS value is specified in hexadecimal format, e.g. 3F.</li> </ul> <p>Enter the relevant value for <i>DSCP Binary Value</i>, <i>DSCP Decimal Value</i>, <i>DSCP Hexadecimal Value</i>, <i>TOS Binary Value</i>, <i>TOS Decimal Value</i> and <i>TOS Hexadecimal Value</i>.</p>
<b>Mode</b>	<p>Select when the interface defined in <b>Route Parameters -&gt; Interface</b> is to be used.</p> <p>Possible values:</p> <ul style="list-style-type: none"> <li>• <i>Dialup and wait</i> (default value): The route can be used if the interface is "up". If the interface is "dormant", then dial and wait until the interface is "up".</li> <li>• <i>Authoritative</i>: The route can always be used.</li> <li>• <i>Dialup and continue</i>: The route can be used when the interface is "up". If the interface is "dormant", then select and use the alternative route (rerouting) until the interface is "up".</li> <li>• <i>Never dialup</i>: The route can be used when the interface is "up".</li> <li>• <i>Always dialup</i>: The route can be used when the interface is "up". If the interface is "dormant", then dial and wait until the interface is "up". In this case, an alternative interface with a poorer metric is used for routing until the interface is "up".</li> </ul>

## 16.1.2 IPv6 Route Configuration

A list of all configured IPv6 routes is displayed in the **Network->Routes->IPv6 Route Configuration** menu.

### 16.1.2.1 Edit or New

Choose the  icon to edit existing entries. Choose the **New** button to create additional routes.

Routes without an  icon have been created by the router automatically and cannot be edited.

The **Network->Routes->IPv6 Route Configuration->New** menu consists of the following fields:

#### Fields in the Route Parameters menu

Field	Description
<b>Description</b>	Enter a description for the IPv6 route.
<b>Route Active</b>	Select if the route is to be active or inactive..  With <i>Enabled</i> the status of the route will be set to active.  The function is enabled by default.
<b>Route Type</b>	Select the type of route.  Possible values: <ul style="list-style-type: none"> <li>• <i>Default Route via Interface</i> : Route via a specific interface which is used if no other adequate route is available.</li> <li>• <i>Default Route via Gateway</i> : Route via a specific gateway which is used if no other adequate route is available.</li> <li>• <i>Host Route via Interface</i>: Route to a single host via a specific interface.</li> <li>• <i>Host Route via Gateway</i>: Route to a single host via a specific gateway.</li> <li>• <i>Network Route via Interface</i>: Route to a network via a specific interface.</li> <li>• <i>Network Route via Gateway</i> (default value): Route to a network via a specific gateway.</li> </ul>
<b>Destination Interface</b>	Select the IPv6 interface to be used for this route.  You can choose from those interfaces available under <b>LAN-&gt;IP Configuration-&gt;Interfaces-&gt;New</b> that are IPv6-enabled.

Field	Description
<b>Source Address / Length</b>	<p>Enter the source IPv6 address along with the corresponding prefix length.</p> <p>: : describes an unspecific address.</p> <p>By default the prefix length <i>64</i> is predefined.</p>
<b>Destination Address / Length</b>	<p>Enter the destination IPv6 address along with the corresponding prefix length.</p> <p>: : describes an unspecific address.</p> <p>By default the prefix length <i>64</i> is predefined.</p>
<b>Gateway Address</b>	Enter a the IPv6 address for the next hop.
<b>Metric</b>	<p>Select the priority of the route.</p> <p>The lower the value, the higher the priority of the route.</p> <p>Value range from <i>0</i> to <i>15</i>. The default value is <i>1</i>.</p>

### 16.1.3 IPv4 Routing Table

A list of all IPv4 routes is displayed in the **Network->Routes->IPv4 Routing Table** menu. The routes do not all need to be active, but can be activated at any time by relevant data traffic.

In the ex works state, a predefined entry with the parameters **Destination IP Address** = *192.168.0.0*, **Netmask** = *255.255.255.0*, **Gateway** = *192.168.0.250*, **Interface** = *LAN\_EN1-0*, **Route Type** = *Network Route via Interface*, **Protocol** = *Local* is displayed.

#### Fields in the menu IPv4 Routing Table

Field	Description
<b>Destination IP Address</b>	Displays the IP address of the destination host or destination network.
<b>Netmask</b>	Displays the netmask of the destination host or destination network.
<b>Gateway</b>	Displays the gateway IP address. Nothing is displayed here

Field	Description
	when routes are received by DHCP.
<b>Interface</b>	Displays the interface used for this route.
<b>Metric</b>	Displays the route's priority. The lower the value, the higher the priority of the route.
<b>Route Type</b>	Displays the route type.
<b>Extended Route</b>	Displays whether a route has been configured with advanced parameters.
<b>Protocol</b>	Displays how the entry has been created , e.g. manually ( <i>Local</i> ) or via one of the available protocols.
<b>Delete</b>	You can delete entries with the  symbol.

## 16.1.4 IPv6 Routing Table

A list of all configured IPv6 routes is displayed in the **Network->Routes->IPv6 Routing Table** menu.

### Fields in the IPv6 Routing Table menu

Field	Description
<b>Route</b>	Displays the source and destination address, which is used for this route, as well as the gateway IP address. Nothing is displayed here when routes are received by DHCP.
<b>Interface</b>	Displays the interface used for this route.
<b>Metric</b>	Displays the route's priority. The lower the value, the higher the priority of the route.
<b>Protocol</b>	Displays how the entry has been created , e.g. manually ( <i>Local</i> ) or via one of the available protocols.

## 16.1.5 Options

### Back Route Verify

The term Back Route Verify describes a very simple but powerful function. If a check is activated for an interface, incoming data packets are only accepted over this interface if outgoing response packets are routed over the same interface. You can therefore prevent the acceptance of packets with false IP addresses - even without using filters.

In the ex works state, the two entries *en1-0* and *ethoa35-5* are displayed by default setting *Enable for specific interfaces*.

The **Networking->Routes->Options** menu consists of the following fields:

#### Fields in the Back Route Verify menu.

Field	Description
<b>Mode</b>	Select how the interfaces to be activated for Back Route Verify are to be specified.  Possible values: <ul style="list-style-type: none"> <li>• <i>Enable for all interfaces</i>: Back Route Verify is activated for all interfaces.</li> <li>• <i>Enable for specific interfaces</i> (default value): A list of all interfaces is displayed in which Back Route Verify is only enabled for specific interfaces.</li> <li>• <i>Disable for all interfaces</i>: Back route verify is disabled for all interfaces.</li> </ul>
<b>No.</b>	Only for <b>Mode</b> = <i>Enable for specific interfaces</i>  Displays the serial number of the list entry.
<b>Interface</b>	Only for <b>Mode</b> = <i>Enable for specific interfaces</i>  Displays the name of the interface.
<b>Back Route Verify</b>	Only for <b>Mode</b> = <i>Enable for specific interfaces</i>  Select whether <i>Back Route Verify</i> is to be activated for the interface.  The function is enabled with <i>Enabled</i> .



Field	Description
	By default, the function is deactivated for all interfaces.

## 16.2 IPv6 General Prefixes

**IPv6 General Prefixes** are usually distributed by IPv6 providers. They can be statically assigned or obtained through DHCP. In most cases, they define /48 or /56 networks. You can derive /64 subnets from these prefixes and have them distributed in your network.

General Prefixes have two key advantages:

- A single route is sufficient for all traffic between the provider and the customer.
- If your provider assigns a new General Prefix through DHCP or changes the static General Prefix assigned to you, there is little or no configuration to be done: In the case of DHCP you obtain the new General Prefix automatically; and in the case of a statically assigned General Prefix, you need to introduce it into your system once. All subnets and IPv6 addresses derived from the General Prefix change automatically after an update.

In order to IPv6 you need to configure how subnets and IPV6 addresses are created and distributed (see Configuring IPv6 addresses in *Interfaces* on page 277 and the menu **LAN->IP Configuration->Interfaces** for the IPv6-relevant parameters.

### 16.2.1 General Prefix Configuration

A list of all configured IPv6 prefixes is displayed in the **Networking->IPv6 General Prefixes->General Prefix Configuration** menu.

#### 16.2.1.1 Edit or New

Choose the  icon to edit existing entries. Choose the **New** button to create additional prefixes.

**Fields in the Basic Parameters menu.**

Field	Description
<b>General Prefix active</b>	Select if the prefix is to be active or inactive..  With <i>Enabled</i> the status of the prefix will be set to active.  The function is enabled by default.
<b>Name</b>	Enter a name for the General Prefix.

Field	Description
	A meaningful name helps selecting the General Prefix from a prefix list.
<b>Type</b>	<p>Specify how the address range is to be assigned.</p> <p>Possible values:</p> <ul style="list-style-type: none"> <li>• <i>Dynamic</i> (default value): The general prefix will be set dynamically by DHCP transmission, e.g. from a provider.</li> <li>• <i>Static</i>: The prefix is fixed, e. g. by a provider.</li> </ul>
<b>From Interface</b>	<p>Only with <b>Type</b> = <i>Dynamic</i></p> <p>Select the IPv6 interface from which a General Prefix is to be obtained.</p> <p>You can choose from all interfaces that are available under <b>LAN-&gt;IP Configuration-&gt;Interfaces-&gt;New</b> and that fulfill the following conditions:</p> <ul style="list-style-type: none"> <li>• <b>IPv6</b> is <i>Enabled</i>.</li> <li>• <b>IPv6 Mode</b> = <i>Host</i></li> <li>• <b>DHCP Client</b> is <i>Enabled</i>.</li> </ul>
<b>Used Prefix / Length</b>	<p>Only with <b>Type</b> = <i>Static</i></p> <p>Enter the prefix to be used. Enter the corresponding length. This prefix must end with ::.</p> <p>The default value is <i>48</i>.</p>

## 16.3 NAT

Network Address Translation (NAT) is a function on your device for defined conversion of source and destination addresses of IP packets. If NAT is activated, IP connections are still only allowed by default in one direction, outgoing (forward) (= protective function). Exceptions to the rule can be configured (in [NAT Configuration](#) on page 338).

Specific instructions for configuring NAT, see the end of the chapter [NAT - Configuration example](#) on page 344.

### 16.3.1 NAT Interfaces

A list of all NAT interfaces is displayed in the **Networking->NAT->NAT Interfaces** menu.

For every NAT interface, the *NAT active*, *Loopback active*, *Silent Deny* and *PPTP Passthrough* can be selected.

In addition, *Portforwardings* displays how many port forwarding rules were configured for this interface.

#### Options in the menu NAT Interfaces

Field	Description
<b>NAT active</b>	Select whether NAT is to be activated for the interface.  The function is disabled by default.
<b>Loopback active</b>	The NAT loopback function also enables network address translation for connectors whereby NAT is not activated. This is often used in order to interpret queries from the LAN as if they were coming from the WAN. You can use this to test the server services.  The function is disabled by default.
<b>Silent Deny</b>	Select whether IP packets are to be silently denied by NAT. If this function is deactivated, the sender of the denied IP packet is informed by means of an appropriate ICMP or TCP RST message.  The function is disabled by default.
<b>PPTP Passthrough</b>	Select whether the setup and operation of several simultaneous, outgoing PPTP connections from hosts in the network are also to be permitted if NAT is activated.  The function is disabled by default.  If <b>PPTP Passthrough</b> is enabled, the device itself cannot be configured as a tunnel endpoint.
<b>Portforwardings</b>	Shows the number of portforwarding rules configured in <b>Networking-&gt;NAT-&gt;NAT Configuration</b> .

## 16.3.2 NAT Configuration

In the **Networking->NAT->NAT Configuration** menu you can exclude data from NAT simply and conveniently as well as translate addresses and ports. For outgoing data traffic you can configure various NAT methods, i.e. you can determine how an external host establishes a connection to an internal host.

### 16.3.2.1 New

Choose the **New** button to set up NAT.

The **Networking->NAT->NAT Configuration ->New** menu consists of the following fields:

#### Fields in the menu Basic Parameters

Field	Description
<b>Description</b>	Enter a description for the NAT configuration.
<b>Interface</b>	Select the interface for which NAT is to be configured.  Possible values: <ul style="list-style-type: none"> <li>• <i>Any</i> (default value): NAT is configured for all interfaces.</li> <li>• <i>&lt;Interface name&gt;</i>: Select one of the interfaces from the list.</li> </ul>
<b>Type of traffic</b>	Select the type of data traffic for which NAT is to be configured.  Possible values: <ul style="list-style-type: none"> <li>• <i>incoming (Destination NAT)</i> (default value): The data traffic that comes from outside.</li> <li>• <i>outgoing (Source NAT)</i>: Outgoing data traffic.</li> <li>• <i>excluding (Without NAT)</i>: Data traffic excluded from NAT.</li> </ul>
<b>NAT method</b>	Only for <b>Type of traffic</b> = <i>outgoing (Source NAT)</i>  Select the NAT method for outgoing data traffic. The starting point for choosing the NAT method is a NAT scenario in which an "internal" source host has initiated an IP connection to an "external" destination host over the NAT interface, and in which an internally valid source address and internally valid source port are translated to an externally valid source address and an ex-

Field	Description
	<p>ternally valid source port.</p> <p>Possible values:</p> <ul style="list-style-type: none"> <li>• <i>full-cone</i> (UDP only): Any given external host may send IP packets via the external address and the external port to the initiating source address and the initial source port.</li> <li>• <i>restricted-cone</i> (UDP only): Like full-cone NAT; as external host, however, only the initial "external" destination host is allowed.</li> <li>• <i>port-restricted-cone</i> (UDP only): Like restricted-cone NAT; however, exclusively data from the initial destination port are allowed.</li> <li>• <i>symmetric</i> (standard value) any protocol: Outbound, an externally valid source address and an externally valid source port are administratively set. Inbound, only response packets within the existing connection are allowed.</li> </ul>

In the **NAT Configuration** -> **Specify original traffic** menu, you can configure for which data traffic NAT is to be used.

#### Fields in the menu **Specify original traffic**

Field	Description
<b>Service</b>	<p>Not for <b>Type of traffic</b> = <i>outgoing</i> (Source NAT) and <b>NAT method</b> = <i>full-cone</i>, <i>restricted-cone</i> or <i>port-restricted-cone</i>.</p> <p>Select one of the preconfigured services.</p> <p>Possible values:</p> <ul style="list-style-type: none"> <li>• <i>User-defined</i> (default value)</li> <li>• <i>&lt;service name&gt;</i></li> </ul>
<b>Action</b>	<p>Only for <b>Type of traffic</b> = <i>excluding</i> (Without NAT)</p> <p>Select which data packets are to be excluded by NAT.</p> <p>Possible values:</p> <ul style="list-style-type: none"> <li>• <i>Exclude</i> (default value): All the data packets that match the following parameters that are to be configured (protocol, source IP address/network mask, destination IP address/net-</li> </ul>

Field	Description
	<p>mask, etc.) are excluded by NAT.</p> <ul style="list-style-type: none"> <li>• <i>Do not exclude</i>: All the data packets that do not match the following parameters that are to be configured (protocol, source IP address/network mask, destination IP address/net-mask, etc.) are excluded by NAT.</li> </ul>
<b>Protocol</b>	<p>Only for certain services.</p> <p>Not for <b>Type of traffic</b> = <i>outgoing (Source NAT)</i> and <b>NAT method</b> = <i>full-cone, restricted-cone</i> or <i>port-restricted-cone</i>. In this case UDP is automatically defined.</p> <p>Select a protocol. According to the selected <b>Service</b>, different protocols are available.</p> <p>Possible values:</p> <ul style="list-style-type: none"> <li>• <i>Any</i> (default value)</li> <li>• <i>AH</i></li> <li>• <i>Chaos</i></li> <li>• <i>EGP</i></li> <li>• <i>ESP</i></li> <li>• <i>GGP</i></li> <li>• <i>GRE</i></li> <li>• <i>HMP</i></li> <li>• <i>ICMP</i></li> <li>• <i>IGMP</i></li> <li>• <i>IGP</i></li> <li>• <i>IGRP</i></li> <li>• <i>IP</i></li> <li>• <i>IPinIP</i></li> <li>• <i>IPv6</i></li> <li>• <i>IPX in IP</i></li> <li>• <i>ISO-IP</i></li> <li>• <i>Kryptolan</i></li> <li>• <i>L2TP</i></li> <li>• <i>OSPF</i></li> </ul>

Field	Description
	<ul style="list-style-type: none"> <li>• PUP</li> <li>• RDP</li> <li>• RSVP</li> <li>• SKIP</li> <li>• TCP</li> <li>• TLSP</li> <li>• UDP</li> <li>• VRRP</li> <li>• XNS-IDP</li> </ul>
<b>Source IP Address/Netmask</b>	<p>Only for <b>Type of traffic</b> = <i>incoming (Destination NAT)</i> or <i>excluding (Without NAT)</i></p> <p>Enter the source IP address and corresponding netmask of the original data packets, as the case arises.</p>
<b>Original Destination IP Address/Netmask</b>	<p>Only for <b>Type of traffic</b> = <i>incoming (Destination NAT)</i></p> <p>Enter the destination IP address and corresponding netmask of the original data packets, as the case arises.</p>
<b>Original Destination Port/Range</b>	<p>Only for <b>Type of traffic</b> = <i>incoming (Destination NAT)</i>, <b>Service</b> = <i>user-defined</i> and <b>Protocol</b> = <i>TCP, UDP, TCP/UDP</i></p> <p>Enter the destination port or the destination port range of the original data packets. The default setting <i>-All-</i> means that the port is not specified.</p>
<b>Original Source IP Address/Netmask</b>	<p>Only for <b>Type of traffic</b> = <i>outgoing (Source NAT)</i></p> <p>Enter the source IP address and corresponding netmask of the original data packets, as the case arises.</p>
<b>Original Source Port/Range</b>	<p>Only for <b>Type of traffic</b> = <i>outgoing (Source NAT)</i>, <b>NAT method</b> = <i>symmetric</i>, <b>Service</b> = <i>user-defined</i> and <b>Protocol</b> = <i>TCP, UDP, TCP/UDP</i></p> <p>Enter the source port of the original data packets. The default setting <i>-All-</i> means that the port remains unspecified.</p>

Field	Description
	If you select <i>Specify port</i> you can specify a single port, if you select <i>Specify port range</i> you can specify a continuous range of ports which will be applied for filtering the outgoing data traffic
<b>Source Port/Range</b>	Only for <b>Type of traffic</b> = <i>excluding (Without NAT)</i> , <b>Service</b> = <i>user-defined</i> and <b>Protocol</b> = <i>TCP, UDP, TCP/UDP</i>  Enter the source port or the source port range of the original data packets. The default setting <i>-All-</i> means that the port remains unspecified.
<b>Destination IP Address/Netmask</b>	Only for <b>Type of traffic</b> = <i>excluding (Without NAT)</i> or <i>outgoing (Source NAT)</i> and <b>NAT method</b> = <i>symmetric</i>  Enter the destination IP address and corresponding netmask of the original data packets, as the case arises.
<b>Destination Port/Range</b>	Only for <b>Type of traffic</b> = <i>outgoing (Source NAT)</i> , <b>NAT method</b> = <i>symmetric</i> , <b>Service</b> = <i>user-defined</i> and <b>Protocol</b> = <i>TCP, UDP, TCP/UDP</i> or <b>Type of traffic</b> = <i>excluding (Without NAT)</i> , <b>Service</b> = <i>user-defined</i> and <b>Protocol</b> = <i>TCP, UDP, TCP/UDP</i>  Enter the destination port or the destination port range of the original data packets. The default setting <i>-All-</i> means that the port remains unspecified.

In the **NAT Configuration** -> **Replacement Values** menu you can define, depending on whether you're dealing with inbound or outbound data traffic, new addresses and ports, to which specific addresses and ports from the **NAT Configuration** -> **Specify original traffic** menu can be translated.

#### Fields in the menu Replacement Values

Field	Description
<b>New Destination IP Address/Netmask</b>	Only for <b>Type of traffic</b> = <i>incoming (Destination NAT)</i>  Enter the destination IP address and corresponding netmask to which the original destination IP address is to be translated.
<b>New Destination Port</b>	Only for <b>Type of traffic</b> = <i>incoming (Destination NAT)</i> , <b>Service</b> = <i>user-defined</i> and <b>Protocol</b> = <i>TCP, UDP, TCP/</i>



Field	Description
	<p><i>UDP</i></p> <p>Leave the destination port as it appears or enter the destination port to which the original destination port is to be translated.</p> <p>Select <i>Original</i> to leave the original destination port. If you disable <i>Original</i>, an input field appears and you can enter a new destination port.</p> <p><i>Original</i> is active by default.</p>
<p><b>New Source IP Address/Netmask</b></p>	<p>Only for <b>Type of traffic</b> = <i>outgoing (Source NAT)</i> and <b>NAT method</b> = <i>symmetric</i></p> <p>Enter the source IP address to which the original source IP address is to be translated, with corresponding netmask, as the case arises.</p>
<p><b>New Source Port</b></p>	<p>Only for <b>Type of traffic</b> = <i>outgoing (Source NAT)</i>, <b>NAT method</b> = <i>symmetric</i>, <b>Service</b> = <i>user-defined</i>, <b>Protocol</b> = <i>TCP, UDP, TCP/UDP</i> and <b>Original Source Port/Range</b> = <i>-All- or Specify port</i></p> <p>Leave the source port as it appears or enter a new source port to which the original source port is to be translated.</p> <p><i>Original</i> leaves the original source port. If you disable <i>Original</i>, an input field appears in which you can enter a new source port. <i>Original</i> is active by default.</p> <p>If you select <i>Specify port range</i> for <b>Original Source Port/Range</b>, you can choose from the following options:</p> <ul style="list-style-type: none"> <li>• <i>Use Original Source Port/Range</i>: The range specified for <b>Original Source Port/Range</b> is not changed, all port numbers are retained.</li> <li>• <i>Use Source Port/Range starting with</i>: There is an input field for you to specify the port number with which to start the port range that replaces the original port range. The count of ports is retained.</li> </ul>

### 16.3.3 NAT - Configuration example

#### Requirements

- Basic configuration of the gateway
- A working Internet access. For example, **Company Connect** with 8 IP addresses.
- The Ethernet interface **ETH** is connected to the access router to the internet (IP address *62.10.10.1/29*)
- The IP address *62.10.10.2* to *62.10.10.6* are entered on Ethernet interface **ETH**.

#### Example scenario

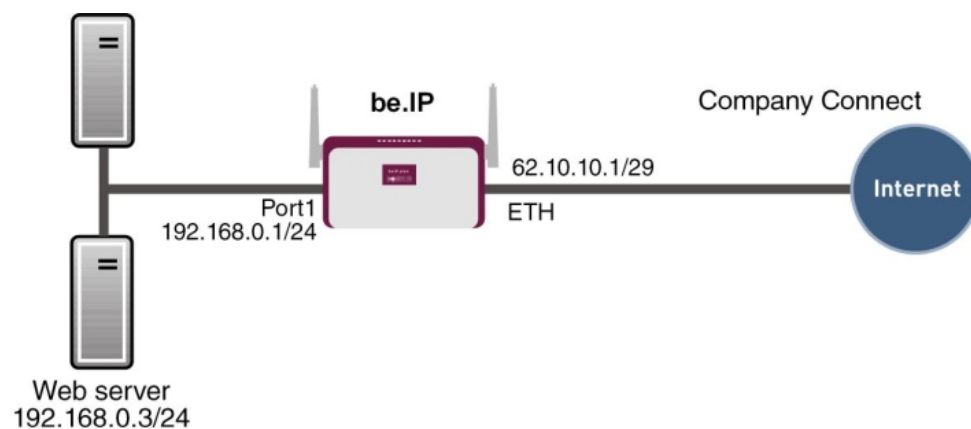

#### Configuration target

- You configure NAT enables for accessing your gateway over HTTP.
- You also want to access your terminal server and the corporate web server over the Internet.

#### Overview of Configuration Steps

##### Enable NAT

Field	Menu	Value
NAT active	Network->NAT->NAT Interfaces	Enabled for LAN_EN5-0
Silent Deny	Network->NAT->NAT Interfaces	Enabled for LAN_EN5-0

##### Configured NAT enables

Field	Menu	Value
Description	Network->NAT->NAT Configuration->New	e.g. <i>GUI</i>
Interface	Network->NAT->NAT Configuration->New	<i>LAN_EN5-0</i>
Type of traffic	Network->NAT->NAT Configuration->New	<i>incoming (Destination NAT)</i>
Service	Network->NAT->NAT Configuration->New	<i>User-defined</i>
Protocol	Network->NAT->NAT Configuration->New	<i>TCP</i>
Original Destination IP Address/Netmask	Network->NAT->NAT Configuration->New	<i>Host, e.g. 62.10.10.2</i>
Original Destination Port/Range	Network->NAT->NAT Configuration->New	<i>80</i>
New Destination IP Address/Netmask	Network->NAT->NAT Configuration->New	<i>127.0.0.1</i>
New Destination Port	Network->NAT->NAT Configuration->New	<i>Original disabled, 80</i>

#### Web server

Field	Menu	Value
Description	Network->NAT->NAT Configuration->New	e.g. <i>Webserver</i>
Interface	Network->NAT->NAT Configuration->New	<i>LAN_EN5-0</i>
Type of traffic	Network->NAT->NAT Configuration->New	<i>incoming (Destination NAT)</i>
Service	Network->NAT->NAT Configuration->New	<i>http</i>
Protocol	Network->NAT->NAT Configuration->New	<i>Host, e.g. 62.10.10.3</i>
Original Destination IP Address/Netmask	Network->NAT->NAT Configuration->New	<i>Host, e.g. 192.168.0.3</i>
New Destination Port	Network->NAT->NAT Configuration->New	<i>Original</i>

**Terminal Server**

Field	Menu	Value
<b>Description</b>	Network->NAT->NAT Configuration->New	e.g. <i>Terminal-Server</i>
<b>Interface</b>	Network->NAT->NAT Configuration->New	<i>LAN_EN5-0</i>
<b>Type of traffic</b>	Network->NAT->NAT Configuration->New	<i>incoming (Destination NAT)</i>
<b>Service</b>	Network->NAT->NAT Configuration->New	<i>User-defined</i>
<b>Protocol</b>	Network->NAT->NAT Configuration->New	<i>TCP</i>
<b>Original Destination IP Address/Netmask</b>	Network->NAT->NAT Configuration->New	<i>96</i>
<b>Original Destination Port/Range</b>	Network->NAT->NAT Configuration->New	<i>3389</i>
<b>New Destination IP Address/Netmask</b>	Network->NAT->NAT Configuration->New	<i>Host, e.g. 192.168.0.2</i>
<b>New Destination Port</b>	Network->NAT->NAT Configuration->New	<i>Original</i>

## 16.4 Load Balancing

The increasing amount of data traffic over the Internet means it is necessary to send data over different interfaces to increase the total bandwidth available. IP load balancing enables the distribution of data traffic within a certain group of interfaces to be controlled.

Specific instructions for configuring load balancing, see [Load balancing - Configuration example](#) on page 353.

### 16.4.1 Load Balancing Groups

If interfaces are combined to form groups, the data traffic within a group is divided according to the following principles:

- In contrast to Multilink PPP-based solutions, load balancing also functions with accounts with different providers.
- Session-based load balancing is achieved.

- Related (dependent) sessions are always routed over the same interface.
- A decision on distribution is only made for outgoing sessions.

A list of all configured load balancing groups is displayed in the **Networking->Load Balancing->Load Balancing Groups** menu. You can click the  icon next to any list entry to go to an overview of the basic parameters that affect this group.



#### Note

Note that the interfaces that are combined into a load balancing group must have routes with the same metric. If necessary, go to the **Networking->Routes** menu and check the entries there.

### 16.4.1.1 New

Choose the **New** button to create additional groups.

The menu **Networking->Load Balancing->Load Balancing Groups->New** consists of the following fields:

#### Fields in the Basic Parameters menu.

Field	Description
<b>Group Description</b>	Enter the desired description of the interface group.
<b>Distribution Policy</b>	<p>Select the way the data traffic is to be distributed to the interfaces configured for the group.</p> <p>Possible values:</p> <ul style="list-style-type: none"> <li>• <i>Session-Round-Robin</i> (default value): A newly added session is assigned to one of the group interfaces according to the percentage assignment of sessions to the interfaces. The number of sessions is decisive.</li> <li>• <i>Load-dependent Bandwidth</i>: A newly added session is assigned to one of the group interfaces according to the share of the total data rate handled by the interfaces. The current data rate based on the data traffic is decisive in both the send and receive direction.</li> </ul>
<b>Consider</b>	<p>Only for <b>Distribution Policy</b> = <i>Load-dependent Bandwidth</i></p> <p>Choose the direction in which the current data rate is to be con-</p>

Field	Description
	<p>sidered.</p> <p>Options:</p> <ul style="list-style-type: none"> <li>• <i>Download</i>: Only the data rate in the receive direction is considered.</li> <li>• <i>Upload</i>: Only the data rate in the send direction is considered.</li> </ul> <p>By default, the <i>Download</i> and <i>Upload</i> options are disabled.</p>
<b>Distribution Mode</b>	<p>Select the state the interfaces in the group may have if they are to be included in load balancing.</p> <p>Possible values:</p> <ul style="list-style-type: none"> <li>• <i>Always</i> (default value): Also includes idle interfaces.</li> <li>• <i>Only use active interfaces</i>: Only interfaces in the up state are included.</li> </ul>

In the **Interface** area, you add interfaces that match the current group context and configure these. You can also delete interfaces.

Use **Add** to create more entries.

#### Fields in the **Basic Parameters** menu.

Field	Description
<b>Group Description</b>	Shows the description of the interface group.
<b>Distribution Policy</b>	Displays the type of data traffic selected.

#### Fields in the **Interface Selection for Distribution** menu.

Field	Description
<b>Interface</b>	Select the interfaces that are to belong to the group from the available interfaces.
<b>Distribution Ratio</b>	<p>Enter the percentage of the data traffic to be assigned to an interface.</p> <p>The meaning differs according to the <b>Distribution Ratio</b> employed:</p>

Field	Description
	<ul style="list-style-type: none"> <li>• For <i>Session-Round-Robin</i> is based on the number of distributed sessions.</li> <li>• For <i>Load-dependent Bandwidth</i>, the data rate is the decisive factor.</li> </ul>

The menu **Advanced Settings** consists of the following fields:

#### Fields in the **Advanced Settings** menu.

Field	Description
<b>Route Selector</b>	<p>The <b>Route Selector</b> parameter is an additional criterion to help define a load balancing group more precisely. Here, routing information is added to the "interface" entry within a load balancing group. The route selector is required in certain scenarios to enable the IP sessions managed by the router to be balanced uniquely for each load balancing group. The following rules apply when using the parameter:</p> <ul style="list-style-type: none"> <li>• If an interface is only assigned to one load balancing group, it is not necessary to configure the route selector.</li> <li>• If an interface is assigned to multiple load balancing groups, configuration of the route selector is essential.</li> <li>• The route selector must be configured identically for all interface entries within a load balancing group.</li> </ul> <p>Select the <b>Destination IP Address</b> of the desired route.</p> <p>You can choose between all routes and all extended routes.</p>
<b>Tracking IP Address</b>	<p>You can use the <b>Tracking IP Address</b> parameter to have a particular route monitored.</p> <p>The load balancing status of the interface and the status of the routes connected to the interface can be influenced using this parameter. This means that routes can be enabled or disabled irrespective of the interface's operation status. The connection is monitored using the gateway's host surveillance function here. Host surveillance entries must be configured in order to use this function. These can be configured in the <b>Local Services-&gt;Surveillance-&gt;Hosts</b> menu. Here, it is important that only the host surveillance entries with the action <b>Monitor</b> are</p>

Field	Description
	<p>taken into account in the context of load balancing. Links between the load balancing function and the host surveillance function are made through the configuration of the <b>Tracking IP Address</b> in the <b>Load Balancing-&gt;Load Balancing Groups-&gt;Advanced Settings</b> menu. The interface's load balancing status now varies according to the status of the assigned host surveillance entry.</p> <p>Select the IP address for the route to be monitored.</p> <p>You can choose from the IP addresses you have entered in the <b>Local Services-&gt;Surveillance-&gt;Hosts-&gt;New</b> menu under <b>Monitored IP Address</b> and which are monitored with the aid of the <b>Action to be executed</b> field (<b>Action</b> = <i>Monitor</i>).</p>

## 16.4.2 Special Session Handling

**Special Session Handling** enables you to route part of the data traffic to your device via a particular interface. This data traffic is excluded from the **Load Balancing** function.

You can use the **Special Session Handling** function with online banking, for example, to ensure that the HTTPS data traffic is sent to a particular link. Since a check is run in online banking to see whether all the data traffic comes from the same source, data transmission using **Load Balancing** might be terminated at times without **Special Session Handling**.

The **Networking->Load Balancing->Special Session Handling** menu displays a list of entries. If you have not configured any entries, the list is empty.

Every entry contains parameters which describe the properties of a data packet in more or less detail. The first data packet which the properties configured here match specifies the route for particular subsequent data packets.

Which data packets are subsequently routed via this route is configured in the **Networking->Load Balancing->Special Session Handling->New->Advanced Settings** menu.

If in the **Networking->Load Balancing->Special Session Handling->New** menu, for example, you select the parameter **Service** = *http (SSL)* (and leave the default value for all the other parameters), the first HTTPS packet specifies the **Destination Address** and the **Destination Port** (i. e. Port 443 with HTTPS) for data packets sent subsequently.

If, under **Frozen Parameters**, for the two parameters **Destination Address** and **Destination Port** you leave the default setting *enabled*, the HTTPS packets with the same source IP address as the first HTTPS packet are routed via port 443 to the same **Destination Address** via the same interface as the first HTTPS packet.



### 16.4.2.1 Edit or New

Choose the  icon to edit existing entries. Select the **New** button create new entries.

The **Networking->Load Balancing->Special Session Handling->New** menu consists of the following fields:

#### Fields in the **Basic Parameters** menu.

Field	Description
<b>Admin Status</b>	<p>Select whether the Special Session Handling should be activated.</p> <p>The function is activated by selecting <i>Enabled</i>.</p> <p>The function is enabled by default.</p>
<b>Description</b>	Enter a name for the entry.
<b>Service</b>	<p>Select one of the preconfigured services, if required. The extensive range of services configured ex works includes the following:</p> <ul style="list-style-type: none"> <li>• <i>activity</i></li> <li>• <i>apple-qt</i></li> <li>• <i>auth</i></li> <li>• <i>charge</i></li> <li>• <i>clients_1</i></li> <li>• <i>daytime</i></li> <li>• <i>dhcp</i></li> <li>• <i>discard</i></li> </ul> <p>The default value is <i>User defined</i>.</p>
<b>Protocol</b>	Select a protocol, if required. The <i>Any</i> option (default value) matches any protocol.
<b>Destination IP Address/Netmask</b>	<p>Enter, if required, the destination IP address and netmask of the data packets.</p> <p>Possible values:</p>

Field	Description
	<ul style="list-style-type: none"> <li>• <i>Any</i> (default value)</li> <li>• <i>Host</i>: Enter the IP address of the host.</li> <li>• <i>Network</i>: Enter the network address and the related netmask.</li> </ul>
<b>Destination Port/Range</b>	<p>Enter, if required, a destination port number or a range of destination port numbers.</p> <p>Possible values:</p> <ul style="list-style-type: none"> <li>• <i>-All-</i> (default value): The destination port is not specified.</li> <li>• <i>Specify port</i>: Enter a destination port.</li> <li>• <i>Specify port range</i>: Enter a destination port range.</li> </ul>
<b>Source Interface</b>	If required, select your device's source interface.
<b>Source IP Address/Netmask</b>	<p>Enter, if required, the source IP address and netmask of the data packets.</p> <p>Possible values:</p> <ul style="list-style-type: none"> <li>• <i>Any</i> (default value)</li> <li>• <i>Host</i>: Enter the IP address of the host.</li> <li>• <i>Network</i>: Enter the network address and the related netmask.</li> </ul>
<b>Source Port/Range</b>	<p>Enter, if required, a source port number or a range of source port numbers.</p> <p>Possible values:</p> <ul style="list-style-type: none"> <li>• <i>-All-</i> (default value): The destination port is not specified.</li> <li>• <i>Specify port</i>: Enter a destination port.</li> <li>• <i>Specify port range</i>: Enter a destination port range.</li> </ul>
<b>Special Handling Timer</b>	<p>Enter the time period during which the specified data packets are to be routed via the route that has been defined.</p> <p>The default value is <i>900</i> seconds.</p>

The menu **Advanced Settings** consists of the following fields:

### Fields in the Advanced Settings menu.

Field	Description
<b>Frozen Parameters</b>	<p>Specify whether, when data packets are subsequently sent, the two parameters <b>Destination Address</b> and <b>Destination Port</b> must have the same value as the first data packet, i. e. whether the subsequent data packets must be routed via the same <b>Destination Port</b> to the same <b>Destination Address</b>.</p> <p>The two parameters <b>Destination Address</b> and <b>Destination Port</b> are enabled by default.</p> <p>If you leave the default setting <i>Enabled</i> for one or both parameters, the value of the parameter concerned must be the same as in the first data packet with data packets sent subsequently.</p> <p>You can disable one or both parameters if you wish.</p> <p>The <b>Source IP Address</b> parameter must always have the same value in data packets sent subsequently as it did in the first data packet. So it cannot be disabled.</p>

## 16.4.3 Load balancing - Configuration example

### Requirements

- Gateway with the ADSL modem integrated
- An external ADSL modem
- Two independent ADSL Internet connections

### Example scenario

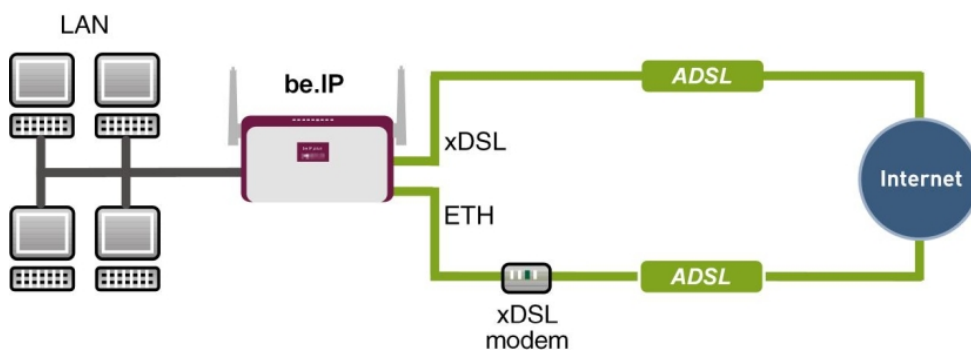

## Configuration target

- The data traffic is distributed half and half to the two ADSL lines based on IP sessions.
- We shall then take the example of encrypted HTTP connections (HTTPS) to describe how to effectively avoid any loss of connection that might occur when distributing to different Internet accesses.



### Note

When creating the ADSL connections, besides the public IP address, the bintec R3002 also obtains the IP addresses of the DNS servers for resolving the name of the configured Internet provider. Particularly when using different Internet providers, the use of the DSN servers needs to be connection-specific.

The configuration of the DNS servers is automatically created when you create the ADSL connections and can be seen in the menu **Local ServicesDNSDNS Server**.

## Overview of Configuration Steps

### Set up first Internet connection

Field	Menu	Value
Connection Type	Assistants->Internet Access->Internet Connections->New	Internal ADSL Modem
Description	Assistants->Internet Access->Internet Connections->New->Next	e.g. ADSL-1
Type	Assistants->Internet Access->Internet Connections->New->Next	User-defined via PPP over Ethernet (PPPoE)
Login Name	Assistants->Internet Access->Internet Connections->New->Next	e.g. feste_ip@provider.de
Password	Assistants->Internet Access->Internet Connections->New->Next	e.g. test12345



### Note

The message you get when you create the second ADSL connection may be ignored. The IP load distribution avoids routing conflicts due to multiple standard routes!

## Set up the second Internet connection

Field	Menu	Value
Connection Type	Assistants->Internet Access->Internet Connections->New	<i>External xDSL Mo-dem</i>
Description	Assistants->Internet Access->Internet Connections->New->Next	e.g. <i>ADSL-2</i>
Physical Ethernet Port	Assistants->Internet Access->Internet Connections->New->Next	e.g. <i>ETH5</i>
Type	Assistants->Internet Access->Internet Connections->New->Next	<i>User-defined</i>
Login Name	Assistants->Internet Access->Internet Connections->New->Next	e.g. <i>#0001@t-online.de</i>
Password	Assistants->Internet Access->Internet Connections->New->Next	e.g. <i>test12345</i>

## Create a load balancing group

Field	Menu	Value
Group Description	Network->Load Balancing->Load Balancing Groups->New	e.g. <i>Internet Access</i>
Distribution Policy	Network->Load Balancing->Load Balancing Groups->New	<i>Session-Round-Robin</i>
Distribution Mode	Network->Load Balancing->Load Balancing Groups->New	<i>Always</i>
Interface	Network->Load Balancing->Load Balancing Groups->New->Add	<i>WAN_ADSL-1</i>
Distribution Ratio	Network->Load Balancing->Load Balancing Groups->New->Add	<i>50</i>
Interface	Network->Load Balancing->Load Balancing Groups->New->Add	<i>WAN_ADSL-2</i>
Distribution Ratio	Network->Load Balancing->Load Balancing Groups->New->Add	<i>50</i>

## Special Session Handling

Field	Menu	Value
Description	Network->Load Balancing->Special Session Handling->New	e.g. <i>HTTPS</i>
Service	Network->Load Balancing->Special Session Handling->New	<i>http (SSL)</i>

Field	Menu	Value
Special Handling Timer	Network->Load Balancing->Special Session Handling->New	900 seconds

## 16.5 QoS

QoS (Quality of Service) makes it possible to distribute the available bandwidths effectively and intelligently. Certain applications can be given preference and bandwidth reserved for them. This is an advantage, especially for time-critical applications such as VoIP.

The QoS configuration consists of three parts:

- Creating IP filters
- Classifying data
- Prioritising data

### 16.5.1 IPv4/IPv6 Filter

In the **Networking->IPv4/IPv6 Filter->QoS Filter** menu IP filters are configured.

The list also displays any configured entries from **Networking->Access Rules->Rule Chains**.

#### 16.5.1.1 New

Choose the **New** button to define more IP filters.

The **Networking->IPv4/IPv6 Filter->QoS Filter->New** menu consists of the following fields:

**Fields in the Basic Parameters menu.**

Field	Description
Description	Enter the name of the filter.
Service	Select one of the preconfigured services. The extensive range of services configured ex works includes the following: <ul style="list-style-type: none"> <li>• <i>activity</i></li> <li>• <i>apple-qt</i></li> <li>• <i>auth</i></li> <li>• <i>charge</i></li> </ul>

Field	Description
	<ul style="list-style-type: none"> <li>• <i>clients_1</i></li> <li>• <i>daytime</i></li> <li>• <i>dhcp</i></li> <li>• <i>discard</i></li> </ul> <p>The default value is <i>User defined</i>.</p>
<b>Protocol</b>	<p>Select a protocol.</p> <p>The <i>Any</i> option (default value) matches any protocol.</p>
<b>Type</b>	<p>Only for <b>Protocol</b> = <i>ICMP</i></p> <p>Select the type.</p> <p>Possible values: <i>Any, Echo reply, Destination unreachable, Source quench, Redirect, Echo, Time exceeded, Timestamp, Timestamp reply</i>.</p> <p>See RFC 792.</p> <p>The default value is <i>Any</i>.</p>
<b>Connection State</b>	<p>With <b>Protocol</b> = <i>TCP</i>, you can define a filter that takes the status of the TCP connections into account.</p> <p>Possible values:</p> <ul style="list-style-type: none"> <li>• <i>Established</i>: All TCP packets that would not open any new TCP connection on routing over the gateway match the filter.</li> <li>• <i>Any</i> (default value): All TCP packets match the filter.</li> </ul>
<b>Destination IPv4 Address/Netmask</b>	<p>Enter the destination IPv4 address of the data packets and the corresponding netmask.</p> <p>Possible values:</p> <ul style="list-style-type: none"> <li>• <i>Any</i> (default value): The destination IP address/netmask are not specified.</li> <li>• <i>Host</i>: Enter the destination IP address of the host.</li> <li>• <i>Network</i>: Enter the destination network address and the corresponding netmask.</li> </ul>
<b>Destination IPv6 Address/Length</b>	<p>Enter the destination IPv6 address of the data packets and the prefix length.</p>

Field	Description
	<p>Possible values:</p> <ul style="list-style-type: none"> <li>• <i>Any</i> (default value): The destination IP address/length are not specified.</li> <li>• <i>Host</i>: Enter the destination IP address of the host.</li> <li>• <i>Network</i>: Enter the destination network address and the prefix length.</li> </ul>
<b>Destination Port/Range</b>	<p>Only for <b>Protocol</b> = <i>TCP</i>, <i>UDP</i> or <i>TCP/UDP</i></p> <p>Enter a destination port number or a range of destination port numbers.</p> <p>Possible values:</p> <ul style="list-style-type: none"> <li>• <i>-All-</i> (default value): The destination port is not specified.</li> <li>• <i>Specify port</i>: Enter a destination port.</li> <li>• <i>Specify port range</i>: Enter a destination port range.</li> </ul>
<b>Source IPv4 Address/Netmask</b>	<p>Enter the source IPv4 address of the data packets and the corresponding netmask.</p> <p>Possible values:</p> <ul style="list-style-type: none"> <li>• <i>Any</i> (default value): The source IP address/netmask are not specified.</li> <li>• <i>Host</i>: Enter the source IP address of the host.</li> <li>• <i>Network</i>: Enter the source network address and the corresponding netmask.</li> </ul>
<b>Source IPv6 Address/Length</b>	<p>Enter the source IPv6 address of the data packets and the prefix length.</p> <p>Possible values:</p> <ul style="list-style-type: none"> <li>• <i>Any</i> (default value): The source IP address/length are not specified.</li> <li>• <i>Host</i>: Enter the source IP address of the host.</li> <li>• <i>Network</i>: Enter the source network address and the prefix length.</li> </ul>
<b>Source Port/Range</b>	<p>Only for <b>Protocol</b> = <i>TCP</i>, <i>UDP</i> or <i>TCP/UDP</i></p> <p>Enter a source port number or a range of source port numbers.</p>



Field	Description
	<p>Possible values:</p> <ul style="list-style-type: none"> <li>• <i>-All-</i> (default value): The source port is not specified.</li> <li>• <i>Specify port</i>: Enter a source port.</li> <li>• <i>Specify port range</i>: Enter a source port range.</li> </ul>
<p><b>DSCP/TOS Filter (Layer 3)</b></p>	<p>Select the Type of Service (TOS).</p> <p>Possible values:</p> <ul style="list-style-type: none"> <li>• <i>Ignore</i> (default value): The type of service is ignored.</li> <li>• <i>DSCP Binary Value</i>: Differentiated Services Code Point according to RFC 3260 is used to signal the priority of IP packets (indicated in binary format, 6 bit).</li> <li>• <i>DSCP Decimal Value</i>: Differentiated Services Code Point according to RFC 3260 is used to signal the priority of IP packets (indicated in decimal format).</li> <li>• <i>DSCP Hexadecimal Value</i>: Differentiated Services Code Point according to RFC 3260 is used to signal the priority of IP packets (indicated in hexadecimal format).</li> <li>• <i>TOS Binary Value</i>: The TOS value is specified in binary format, e.g. 00111111.</li> <li>• <i>TOS Decimal Value</i>: The TOS value is specified in decimal format, e.g. 63.</li> <li>• <i>TOS Hexadecimal Value</i>: The TOS value is specified in hexadecimal format, e.g. 3F.</li> </ul>
<p><b>COS Filter (802.1p/Layer 2)</b></p>	<p>Enter the service class of the IP packets (Class of Service, CoS).</p> <p>Value range 0 to 7.</p> <p>The default value is 0.</p> <p>The default value is <i>Ignore</i>.</p>

## 16.5.2 QoS Classification

The data traffic is classified in the **Networking->QoS->QoS Classification** menu, i.e. the data traffic is associated using class IDs of various classes. To do this, create class plans for classifying IP packets based on pre-defined IP filters. Each class plan is associated to at least one interface via its first filter.

### 16.5.2.1 New

Choose the **New** button to create additional data classes.

The **Networking->QoS->QoS Classification->New** menu consists of the following fields:

#### Fields in the **Basic Parameters** menu.

Field	Description
<b>Class map</b>	<p>Choose the class plan you want to create or edit.</p> <p>Possible values:</p> <ul style="list-style-type: none"> <li><i>New</i> (default value): You can create a new class plan with this setting.</li> <li><i>&lt;Name of class plan&gt;</i>: Shows a class plan that has already been created, which you can select and edit. You can add new filters.</li> </ul>
<b>Description</b>	<p>Only for <b>Class map</b> = <i>New</i></p> <p>Enter the name of the class plan.</p>
<b>Filter</b>	<p>Select an IP filter.</p> <p>If the class plan is new, select the filter to be set at the first point of the class plan.</p> <p>If the class plan already exists, select the filter to be attached to the class plan.</p> <p>To select a filter, at least one filter must be configured in the <b>Networking-&gt;QoS-&gt;QoS Filter</b> menu.</p>
<b>Direction</b>	<p>Select the direction of the data packets to be classified.</p> <p>Possible values:</p>

Field	Description
	<ul style="list-style-type: none"> <li>• <i>Incoming</i>: Incoming data packets are assigned to the class (<b>Class ID</b>) that is then to be defined.</li> <li>• <i>Outgoing</i> (default value): Outgoing data packets are assigned to the class (<b>Class ID</b>) that is then to be defined.</li> <li>• <i>Both</i>: Incoming and outgoing data packets are assigned to the class (<b>Class ID</b>) that is then to be defined.</li> </ul>
<b>High Priority Class</b>	<p>Enable or disable the high priority class. If the high priority class is active, the data packets are associated with the class with the highest priority and priority 0 is set automatically.</p> <p>The function is enabled with <i>Enabled</i>.</p> <p>The function is disabled by default.</p>
<b>Class ID</b>	<p>Only for <b>High Priority Class</b> not active.</p> <p>Choose a number which assigns the data packets to a class.</p> <div data-bbox="539 821 1316 978" style="border: 1px solid gray; background-color: #f0f0f0; padding: 5px; margin: 10px 0;">  <p><b>Note</b></p> <p>The class ID is a label to assign data packets to specific classes. (The class ID does not define the priority.)</p> </div> <p>Possible values are whole numbers between <i>1</i> and <i>254</i>.</p>
<b>Set DSCP/Traffic Class Filter (Layer 3)</b>	<p>Here you can set or change the DSCP/TOS value of the IP data packets, based on the class (<b>Class ID</b>) that has been defined.</p> <p>Possible values:</p> <ul style="list-style-type: none"> <li>• <i>Preserve</i> (default value): The DSCP/TOS value of the IP data packets remains unchanged.</li> <li>• <i>DSCP Binary Value</i>: Differentiated Services Code Point according to RFC 3260 is used to signal the priority of IP packets (indicated in binary format).</li> <li>• <i>DSCP Decimal Value</i>: Differentiated Services Code Point according to RFC 3260 is used to signal the priority of IP packets (indicated in decimal format).</li> <li>• <i>DSCP Hexadecimal Value</i>: Differentiated Services Code Point according to RFC 3260 is used to signal the priority of IP packets (indicated in hexadecimal format).</li> </ul>

Field	Description
	<ul style="list-style-type: none"> <li>• <i>TOS Binary Value</i>: The TOS value is specified in binary format, e.g. 00111111.</li> <li>• <i>TOS Decimal Value</i>: The TOS value is specified in decimal format, e.g. 63.</li> <li>• <i>TOS Hexadecimal Value</i>: The TOS value is specified in hexadecimal format, e.g. 3F.</li> </ul>
<b>Set COS value (802.1p/Layer 2)</b>	<p>In the header of the Ethernet packets filtered by the selected filter, you can here set/change the service class (Layer 2 priority).</p> <p>Possible values are whole numbers between 0 and 7.</p> <p>The default value is <i>Preserve</i>.</p>
<b>Interfaces</b>	<p>Only for <b>Class map = New</b></p> <p>When creating a new class plan, select the interfaces to which you want to link the class plan. A class plan can be assigned to multiple interfaces.</p>

### 16.5.3 QoS Interfaces/Policies

In the **Networking->QoS->QoS Interfaces/Policies** menu, you set prioritisation of data.



#### Note

Data can only be prioritized in the outgoing direction.

Packets in the high-priority class always take priority over data with class IDs 1 - 254.

It is possible to assign or guarantee each queue and thus each data class a certain part of the total bandwidth of the interface. In addition, you can optimise the transmission of voice data (real time data).

Depending on the respective interface, a queue is created automatically for each class, but only for data traffic classified as outgoing and for data traffic classified in both directions. A priority is assigned to these automatic queues. The value of the priority is equal to the value of the class ID. You can change the default priority of a queue. If you add new queues, you can also use classes in other class plans via the class ID.

### 16.5.3.1 New

Choose the **New** button to create additional prioritisations.

The **Networking->QoS->QoS Interfaces/Policies->New** menu consists of the following fields:

#### Fields in the **Basic Parameters** menu.

Field	Description
<b>Interface</b>	Select the interface for which QoS is to be configured.
<b>Prioritisation Algorithm</b>	<p>Select the algorithm according to which the queues are to be processed. This activates and deactivates QoS on the selected interface.</p> <p>Possible values:</p> <ul style="list-style-type: none"> <li>• <i>Priority Queueing</i>: QoS is activated on the interface. The available bandwidth is distributed strictly according to the queue priority.</li> <li>• <i>Weighted Round Robin</i>: QoS is activated on the interface. The available bandwidth is distributed according to the weighting (weight) of the queue. Exception: High-priority packets are always handled with priority.</li> <li>• <i>Weighted Fair Queueing</i>: QoS is activated on the interface. The available bandwidth is distributed as “fairly” as possible among the (automatically detected) traffic flows in a queue. Exception: High-priority packets are always handled with priority.</li> <li>• <i>Disabled</i> (default value): QoS is deactivated on the interface. The existing configuration is not deleted, but can be activated again if required.</li> </ul>
<b>Traffic shaping</b>	<p>Activate or deactivate data rate limiting in the send direction.</p> <p>The function is enabled with <i>Enabled</i>.</p> <p>The function is disabled by default.</p>
<b>Maximum Upload Speed</b>	<p>Only for <b>Traffic shaping</b> = enabled.</p> <p>Enter a maximum data rate for the selected interface in the</p>

Field	Description
	<p>send direction in kbit per second.</p> <p>Possible values are <i>0</i> to <i>1000000</i>.</p> <p>The default value is <i>0</i>, i.e. no limits are set, the selected interface can occupy its maximum bandwidth.</p>
<p><b>Protocol Header Size below Layer 3</b></p>	<p>Only for <b>Traffic shaping</b> = enabled.</p> <p>Choose the interface type to include the size of the respective overheads of a datagram when calculating the bandwidth.</p> <p>Possible values:</p> <ul style="list-style-type: none"> <li>• <i>User defined</i>: Value in byte.</li> </ul> <p>Possible values are <i>0</i> to <i>100</i>.</p> <ul style="list-style-type: none"> <li>• <i>Undefined (Protocol Header Offset=0)</i> (default value)</li> </ul> <p>Can only be selected for Ethernet interfaces</p> <ul style="list-style-type: none"> <li>• <i>Ethernet</i></li> <li>• <i>Ethernet and VLAN</i></li> <li>• <i>PPP over Ethernet</i></li> <li>• <i>PPP over Ethernet and VLAN</i></li> </ul> <p>Can only be selected for IPSec interfaces:</p> <ul style="list-style-type: none"> <li>• <i>IPSec over Ethernet</i></li> <li>• <i>IPSec over Ethernet and VLAN</i></li> <li>• <i>IPSec via PPP over Ethernet</i></li> <li>• <i>IPSec via PPPoE and VLAN</i></li> </ul>
<p><b>Encryption Method</b></p>	<p>Only if an IPSec Peers is selected as <b>Interface</b>, <b>Traffic shaping</b> is <i>Active</i> and <b>Protocol Header Size below Layer 3</b> is not <i>Undefiniert (Protocol Header Offset=0)</i>.</p> <p>Select the encryption method used for the IPSec connection. The encryption algorithm determines the length of the block cipher which is taken into account during bandwidth calculation.</p> <p>Possible values:</p>

Field	Description
	<ul style="list-style-type: none"> <li>• <i>DES, 3DES, Blowfish, Cast</i> - (cipher block size = 64 Bit)</li> <li>• <i>AES128, AES192, AES256, Twofish</i> - (cipher block size = 128 Bit)</li> </ul>
<b>Real Time Jitter Control</b>	<p>Only for <b>Traffic shaping</b> = enabled</p> <p>Real Time Jitter Control optimises latency when forwarding real time datagrams. The function ensures that large data packets are fragmented according to the available upload bandwidth.</p> <p>Real Time Jitter Control is useful for small upload bandwidths (&lt; 800 kbps).</p> <p>Activate or deactivate Real Time Jitter Control.</p> <p>The function is enabled with <i>Enabled</i>.</p> <p>The function is disabled by default.</p>
<b>Control Mode</b>	<p>Only for <b>Real Time Jitter Control</b> = enabled.</p> <p>Select the mode for optimising voice transmission.</p> <p>Possible values:</p> <ul style="list-style-type: none"> <li>• <i>All RTP Streams</i>: All RTP streams are optimised. The function activates the RTP stream detection mechanism for the automatic detection of RTP streams. In this mode, the Real Time Jitter Control is activated as soon as an RTP stream has been detected.</li> <li>• <i>Inactive</i>: Voice data transmission is not optimised.</li> <li>• <i>Controlled RTP Streams only</i>: This mode is used if either the VoIP Application Layer Gateway (ALG) or the VoIP Media Gateway (MGW) is active. Real Time Jitter Control is activated by the control instances ALG or MGW.</li> <li>• <i>Always</i>: Real Time Jitter Control is always active, even if no real time data is routed.</li> </ul>
<b>Queues/Policies</b>	<p>Configure the desired QoS queues.</p> <p>For each class created from the class plan, which is associated with the selected interface, a queue is generated automatically and displayed here (only for data traffic classified as outgoing</p>

Field	Description
	<p>and for data traffic classified as moving in both directions).</p> <p>Add new entries with <b>Add</b>. The <b>Edit Queue/Policy</b> menu opens.</p> <p>By creating a QoS policy a DEFAULT entry with the lowest priority 255 is automatically created.</p>

The menu **Edit Queue/Policy** consists of the following fields:

#### Fields in the **Edit Queue/Policy** menu.

Field	Description
<b>Description</b>	Enter the name of the queue/policy.
<b>Outbound Interface</b>	Shows the interface for which the QoS queues are being configured.
<b>Prioritisation queue</b>	<p>Select the queue priority type.</p> <p>Possible values:</p> <ul style="list-style-type: none"> <li>• <i>Class Based</i> (default value): Queue for data classified as “normal”.</li> <li>• <i>High Priority</i>: Queue for data classified as “high priority”.</li> <li>• <i>Default</i>: Queue for data that has not been classified or data of a class for which no queue has been configured.</li> </ul>
<b>Class ID</b>	<p>Only for <b>Prioritisation queue</b> = <i>Class Based</i></p> <p>Select the QoS packet class to which this queue is to apply.</p> <p>To do this, at least one class ID must be given in the <b>Networking-&gt;QoS-&gt;QoS Classification</b> menu.</p>
<b>Priority</b>	<p>Only for <b>Prioritisation queue</b> = <i>Class Based</i></p> <p>Choose the priority of the queue. Possible values are 1 (high priority) to 254 (low priority).</p> <p>The default value is 1.</p>
<b>Weight</b>	<p>Only for <b>Prioritisation Algorithm</b> = <i>Weighted Round Robin</i> or <i>Weighted Fair Queueing</i></p>



Field	Description
	<p>Choose the priority of the queue. Possible values are 1 to 254.</p> <p>The default value is 1.</p>
<b>RTT Mode (Realtime Traffic Mode)</b>	<p>Active or deactivate the real time transmission of the data.</p> <p>The function is enabled with <i>Enabled</i>.</p> <p>The function is disabled by default.</p> <p>RTT mode should be activated for QoS classes in which real time data has priority. This mode improves latency when forwarding real time datagrams.</p> <p>It is possible to configure multiple queues when RTT mode is enabled. Queues with enabled RTT mode must always have a higher priority than queues with disabled RTT mode.</p>
<b>Traffic Shaping</b>	<p>Activate or deactivate data rate (=Traffic Shaping) limiting in the send direction.</p> <p>The data rate limit applies to the selected queue. (This is not the limit that can be defined on the interface.)</p> <p>The function is enabled with <i>Enabled</i>.</p> <p>The function is disabled by default.</p>
<b>Maximum Upload Speed</b>	<p>Only for <b>Traffic Shaping</b> = enabled.</p> <p>Enter a maximum data rate for the queue in kbits.</p> <p>Possible values are 0 to 1000000.</p> <p>The default value is 0.</p>
<b>Overbooking allowed</b>	<p>Only for <b>Traffic Shaping</b> = enabled.</p> <p>Enable or disable the function. The function controls the bandwidth limit.</p> <p>If <b>Overbooking allowed</b> is activated, the bandwidth limit set for this queue can be exceeded, as long as free bandwidth exists on the interface.</p> <p>If <b>Overbooking allowed</b> is deactivated, the queue can never</p>

Field	Description
	<p>occupy bandwidth beyond the bandwidth limit that has been set.</p> <p>The function is enabled with <i>Enabled</i>.</p> <p>The function is disabled by default.</p>
<b>Burst size</b>	<p>Only for <b>Traffic Shaping</b> = enabled.</p> <p>Enter the maximum number of bytes that may still be transmitted temporarily when the data rate permitted for this queue has been reached.</p> <p>Possible values are 0 to 64000.</p> <p>The default value is 0.</p>

The menu **Advanced Settings** consists of the following fields:

#### Fields in the **Advanced Settings** menu.

Field	Description
<b>Dropping Algorithm</b>	<p>Choose the procedure for rejecting packets in the QoS queue, if the maximum size of the queue is exceeded.</p> <p>Possible values:</p> <ul style="list-style-type: none"> <li>• <i>Tail Drop</i> (default value): The newest packet received is dropped.</li> <li>• <i>Head Drop</i>: The oldest packet in the queue is dropped.</li> <li>• <i>Random Drop</i>: A randomly selected packet is dropped from the queue.</li> </ul>
<b>Congestion Avoidance (RED)</b>	<p>Enable or disable preventative deletion of data packets.</p> <p>Packets which have a data size of between <b>Min. queue size</b> and <b>Max. queue size</b> are preventively dropped to prevent queue overflow (RED=Random Early Detection). This procedure ensures a smaller long-term queue size for TCP-based data traffic, so that traffic bursts can also usually be transmitted without large packet losses.</p> <p>The function is activated with <i>Enabled</i>.</p> <p>The function is disabled by default.</p>

Field	Description
<b>Min. queue size</b>	<p>Enter the lower threshold value for the process <b>Congestion Avoidance (RED)</b> in bytes.</p> <p>Possible values are <i>0</i> to <i>262143</i>.</p> <p>The default value is <i>0</i>.</p>
<b>Max. queue size</b>	<p>Enter the upper threshold value for the process <b>Congestion Avoidance (RED)</b> in bytes.</p> <p>Possible values are <i>0</i> to <i>262143</i>.</p> <p>The default value is <i>16384</i>.</p>

## 16.6 Access Rules

Accesses to data and functions are restricted with access lists (which user gets to use which services and files).

You define filters for IP packets in order to allow or block access from or to the various hosts in connected networks. This enables you to prevent undesired connections being set up via the gateway. Access lists define the type of IP traffic the gateway is to accept or deny. The access decision is based on information contained in the IP packets, e.g.:

- source and/or destination IP address
- packet protocol
- source and/or destination port (port ranges are supported)

Access lists are an effective means if, for example, sites with LANs interconnected over a bintec elmeg gateway wish to deny all incoming FTP requests or only allow Telnet sessions between certain hosts.

Access filters in the gateway are based on the combination of filters and actions for filter rules (= rules) and the linking of these rules to form rule chains. They act on the incoming data packets to allow or deny access to the gateway for certain data.

A filter describes a certain part of the IP data traffic based on the source and/or destination IP address, netmask, protocol and source and/or destination port.

You use the rules that you set up in the access lists to tell the gateway what to do with the filtered data packets, i.e. whether it should allow or deny them. You can also define several rules, which you arrange in the form of a chain to obtain a certain sequence.

There are various approaches for the definition of rules and rule chains:

Allow all packets that are not explicitly denied, i.e.:

- Deny all packets that match Filter 1.
- Deny all packets that match Filter 2.
- ...
- Allow the rest.

or

Allow all packets that are explicitly allowed, i.e.:

- Allow all packets that match Filter 1.
- Allow all packets that match Filter 2.
- ...
- Deny the rest.

or

Combination of the two possibilities described above.

A number of separate rule chains can be created. The same filter can also be used in different rule chains.

You can also assign a rule chain individually to each interface.



### Caution

Make sure you don't lock yourself out when configuring filters.

If possible, access your gateway for filter configuration over the serial console (not available for all devices) interface or ISDN Login.

## 16.6.1 Access Filter

This menu is for configuration of access filter. Each filter describes a certain part of the IP traffic and defines, for example, the IP addresses, the protocol, the source port or the destination port.

A list of all access filters is displayed in the **Networking->Access Rules->Access Filter** menu.

### 16.6.1.1 Edit or New

Choose the  icon to edit existing entries. To configure access filters, select the **New** button.

The **Networking->Access Rules->Access Filter->New** menu consists of the following fields:

#### Fields in the **Basic Parameters** menu.

Field	Description
<b>Description</b>	Enter a description for the filter.
<b>Service</b>	<p>Select one of the preconfigured services. The extensive range of services configured ex works includes the following:</p> <ul style="list-style-type: none"> <li>• <i>activity</i></li> <li>• <i>apple-qt</i></li> <li>• <i>auth</i></li> <li>• <i>charge</i></li> <li>• <i>clients_1</i></li> <li>• <i>daytime</i></li> <li>• <i>dhcp</i></li> <li>• <i>discard</i></li> </ul> <p>The default value is <i>User defined</i>.</p>
<b>Protocol</b>	<p>Select a protocol.</p> <p>The <i>Any</i> option (default value) matches any protocol.</p>
<b>Type</b>	<p>Only if <b>Protocol</b> = <i>ICMP</i></p> <p>Possible values:</p> <ul style="list-style-type: none"> <li>• <i>Any</i></li> <li>• <i>Echo reply</i></li> <li>• <i>Destination unreachable</i></li> <li>• <i>Source quench</i></li> <li>• <i>Redirect</i></li> <li>• <i>Echo</i></li> </ul>

Field	Description
	<ul style="list-style-type: none"> <li>• <i>Time exceeded</i></li> <li>• <i>Timestamp</i></li> <li>• <i>Timestamp reply</i></li> </ul> <p>The default value is <i>Any</i>.</p> <p>See RFC 792.</p>
<b>Connection State</b>	<p>Only if <b>Protocol</b> = <i>TCP</i></p> <p>You can define a filter that takes the status of the TCP connections into account.</p> <p>Possible values:</p> <ul style="list-style-type: none"> <li>• <i>Any</i> (default value): All TCP packets match the filter.</li> <li>• <i>Established</i>: All TCP packets that would not open any new TCP connection on routing over the gateway match the filter.</li> </ul>
<b>Destination IPv4 Address/Netmask</b>	<p>Enter the destination IPv4 address of the data packets and the corresponding netmask.</p> <p>Possible values:</p> <ul style="list-style-type: none"> <li>• <i>Any</i> (default value): The destination IP address/netmask are not specified.</li> <li>• <i>Host</i>: Enter the destination IP address of the host.</li> <li>• <i>Network</i>: Enter the destination network address and the corresponding netmask.</li> </ul>
<b>Destination IPv6 Address/Length</b>	<p>Enter the destination IPv6 address of the data packets and the prefix length.</p> <p>Possible values:</p> <ul style="list-style-type: none"> <li>• <i>Any</i> (default value): The destination IP address/length are not specified.</li> <li>• <i>Host</i>: Enter the destination IP address of the host.</li> <li>• <i>Network</i>: Enter the destination network address and the prefix length.</li> </ul>
<b>Destination Port/Range</b>	<p>Only if <b>Protocol</b> = <i>TCP, UDP</i></p> <p>Enter a destination port number or a range of destination port numbers that matches the filter.</p>

Field	Description
	<p>Possible values:</p> <ul style="list-style-type: none"> <li>• <i>-All-</i> (default value): The filter is valid for all port numbers</li> <li>• <i>Specify port</i>: Enables the entry of a port number.</li> <li>• <i>Specify port range</i>: Enables the entry of a range of port numbers.</li> </ul>
<b>Source IPv4 Address/Netmask</b>	<p>Enter the source IPv4 address of the data packets and the corresponding netmask.</p> <p>Possible values:</p> <ul style="list-style-type: none"> <li>• <i>Any</i> (default value): The source IP address/netmask are not specified.</li> <li>• <i>Host</i>: Enter the source IP address of the host.</li> <li>• <i>Network</i>: Enter the source network address and the corresponding netmask.</li> </ul>
<b>Source IPv6 Address/Length</b>	<p>Enter the source IPv6 address of the data packets and the prefix length.</p> <p>Possible values:</p> <ul style="list-style-type: none"> <li>• <i>Any</i> (default value): The source IP address/length are not specified.</li> <li>• <i>Host</i>: Enter the source IP address of the host.</li> <li>• <i>Network</i>: Enter the source network address and the prefix length.</li> </ul>
<b>Source Port/Range</b>	<p>Only if <b>Protocol</b> = <i>TCP, UDP</i></p> <p>Enter a source port number or the range of source port numbers.</p> <p>Possible values:</p> <ul style="list-style-type: none"> <li>• <i>-All-</i> (default value): The filter is valid for all port numbers</li> <li>• <i>Specify port</i>: Enables the entry of a port number.</li> <li>• <i>Specify port range</i>: Enables the entry of a range of port numbers.</li> </ul>
<b>DSCP/TOS Filter (Layer 3)</b>	<p>Select the Type of Service (TOS).</p> <p>Possible values:</p>

Field	Description
	<ul style="list-style-type: none"> <li>• <i>Ignore</i> (default value): The type of service is ignored.</li> <li>• <i>DSCP Binary Value</i>: Differentiated Services Code Point according to RFC 3260 is used to signal the priority of IP packets (indicated in binary format, 6 bit).</li> <li>• <i>DSCP Decimal Value</i>: Differentiated Services Code Point according to RFC 3260 is used to signal the priority of IP packets (indicated in decimal format).</li> <li>• <i>DSCP Hexadecimal Value</i>: Differentiated Services Code Point according to RFC 3260 is used to signal the priority of IP packets (indicated in hexadecimal format).</li> <li>• <i>TOS Binary Value</i>: The TOS value is specified in binary format, e.g. 00111111.</li> <li>• <i>TOS Decimal Value</i>: The TOS value is specified in decimal format, e.g. 63.</li> <li>• <i>TOS Hexadecimal Value</i>: The TOS value is specified in hexadecimal format, e.g. 3F.</li> </ul>
<b>COS Filter (802.1p/Layer 2)</b>	<p>Enter the service class of the IP packets (Class of Service, CoS).</p> <p>Possible values are whole numbers between 0 and 7.</p> <p>The default value is <i>Ignore</i>.</p>

## 16.6.2 Rule Chains

Rules for IP filters are configured in the **Rule Chains** menu. These can be created separately or incorporated in rule chains.

In the **Networking->Access Rules->Rule Chains** menu, all created filter rules are listed.

### 16.6.2.1 Edit or New

Choose the  icon to edit existing entries. To configure access lists, select the **New** button.

The **Networking->Access Rules->Rule Chains->New** menu consists of the following fields:

**Fields in the Basic Parameters menu.**



Field	Description
<b>Rule Chain</b>	<p>Select whether to create a new rule chain or to edit an existing one.</p> <p>Possible values:</p> <ul style="list-style-type: none"> <li>• <i>New</i> (default value): You can create a new rule chain with this setting.</li> <li>• <i>&lt;Name of the rule chain&gt;</i>: Select an already existing rule chain, and thus add another rule to it.</li> </ul>
<b>Description</b>	Enter the name of the rule chain.
<b>Access Filter</b>	<p>Select an IP filter.</p> <p>If the rule chain is new, select the filter to be set at the first point of the rule chain.</p> <p>If the rule chain already exists, select the filter to be attached to the rule chain.</p>
<b>Action</b>	<p>Define the action to be taken for a filtered data packet.</p> <p>Possible values:</p> <ul style="list-style-type: none"> <li>• <i>Allow if filter matches</i> (default value): Allow packet if it matches the filter.</li> <li>• <i>Allow if filter does not match</i>: Allow packet if it does not match the filter.</li> <li>• <i>Deny if filter matches</i>: Deny packet if it matches the filter.</li> <li>• <i>Deny if filter does not match</i>: Deny packet if it does not match the filter.</li> <li>• <i>Ignore</i>: Use next rule.</li> </ul>

To set the rules of a rule chain in a different order select the  button in the list menu for the entry to be shifted. A dialog box opens, in which you can decide under **Move** whether the entry *below* (default value) or *above* another rule of this rule chain is to be shifted.

### 16.6.3 Interface Assignment

In this menu, the configured rule chains are assigned to the individual interfaces and the gateway's behavior is defined for denying IP packets.

A list of all configured interface assignments is displayed in the **Networking->Access Rules->Interface Assignment** menu.

### 16.6.3.1 Edit or New

Choose the  icon to edit existing entries. Choose the **New** button to configure additional assignments.

The **Networking->Access Rules->Interface Assignment->New** menu consists of the following fields:

#### Fields in the **Basic Parameters** menu.

Field	Description
<b>Interface</b>	Select the interface for which a configured rule chain is to be assigned.
<b>Rule Chain</b>	Select a rule chain.
<b>Silent Deny</b>	<p>Define whether the sender is to be informed if an IP packet is denied.</p> <ul style="list-style-type: none"> <li>• <i>Enabled</i> (default value): The sender is not informed.</li> <li>• <i>Disabled</i>: The sender receives an ICMP message.</li> </ul>
<b>Reporting Method</b>	<p>Define whether a syslog message is to be generated if a packet is denied.</p> <p>Possible values:</p> <ul style="list-style-type: none"> <li>• <i>No report</i>: No syslog message.</li> <li>• <i>Info</i> (default value): A syslog message is generated with the protocol number, source IP address and source port number.</li> <li>• <i>Dump</i>: A syslog message is generated with the contents of the first 64 bytes of the denied packet.</li> </ul>

## Chapter 17 Multicast

### What is multicasting?

Many new communication technologies are based on communication from one sender to several recipients. Therefore, modern telecommunication systems such as voice over IP or video and audio streaming (e.g. IPTV or Webradio) focus on reducing data traffic, e.g. by offering TriplePlay (voice, video, data). Multicast is a cost-effective solution for effective use of bandwidth because the sender of the data packet, which can be received by several recipients, only needs to send the packet once. The packet is sent to a virtual address defined as a multicast group. Interested recipients log in to these groups.

### Other areas of use

One classic area in which multicast is used is for conferences (audio/video) with several recipients. The most well-known are probably the Mbone Multimedia Audio Tool (VAT), Video Conferencing Tool (VIC) and Whiteboard (WB). VAT can be used to hold audio conferences. All subscribers are displayed in a window and the speaker(s) are indicated by a black box. Other areas of use are of particular interest to companies. Here, multicasting makes it possible to synchronise the databases of several servers, which is valuable for multinationals or even companies with just a few locations.

### Address range for multicast

For, IPv4 the IP addresses 224.0.0.0 to 239.255.255.255 (224.0.0.0/4) are reserved for multicast in the class D network. An IP address from this range represents a multicast group to which several recipients can log in. The multicast router then forwards the required packets to all subnets with logged in recipients.

### Multicast basics

Multicast is connectionless, which means that any trouble-shooting or flow control needs to be guaranteed at application level.

At transport level, UDP is used almost exclusively, as, in contrast to TCP, it is not based on a point-to-point connection.

At IP level, the main difference is therefore that the destination address does not address a

dedicated host, but rather a group, i.e. during the routing of multicast packets, the decisive factor is whether a recipient is in a logged-in subnet.

In the local network, all hosts are required to accept all multicast packets. For Ethernet or FDD, this is based on MAC mapping, where the group address is encoded into the destination MAC address. For routing between several networks, the routers first need to make themselves known to all potential recipients in the subnet. This is achieved by means of Membership Management protocols such as IGMP for IPv4 and MLP for IPv6.

## Membership Management protocol

In IPv4, IGMP (Internet Group Management Protocol) is a protocol that hosts can use to provide the router with multicast membership information. IP addresses of the class D address range are used for addressing. An IP address in this class represents a group. A sender (e.g. Internet radio) sends data to this group. The addresses (IP) of the various senders within a group are called the source (addresses). Several senders (with different IP addresses) can therefore transmit to the same multicast group, leading to a 1-to-n relationship between groups and source addresses. This information is forwarded to the router by means of reports. In the case of incoming multicast data traffic, a router can use this information to decide whether a host in its subnet wants to receive it. Your device supports the current version IGMP V3, which is upwardly compatible, which means that both V3 and V1/V2 hosts can be managed.

Your device supports the following multicast mechanisms:

- Forwarding: This relates to static forwarding, i.e. incoming data traffic for a group is passed in all cases. This is a useful option if multicast data traffic is to be permanently passed.
- IGMP: IGMP is used to gather information about the potential recipients in a subnet. In the case of a hop, incoming multicast data traffic can thus be selected.



### Tip

With multicast, the focus is on excluding data traffic from unwanted multicast groups. Note that if forwarding is combined with IGMP, the packets can be forwarded to the groups specified in the forwarding request.

## 17.1 General

## 17.1.1 General

In the **Multicast->General->General** menu you can disable or enable the multicast function.

The **Multicast->General->General** menu consists of the following fields:

### Fields in the Basic Settings menu.

Field	Description
<b>Multicast Routing</b>	<p>Select whether <b>Multicast Routing</b> should be used.</p> <p>The function is enabled with <i>Enabled</i>.</p> <p>The function is disabled by default.</p>

## 17.2 IGMP

IGMP (Internet Group Management Protocol, see RFC 3376) is used to signal the information about group (membership) in a subnet. As a result, only the packets explicitly wanted by a host enter the subnet.

Special mechanisms ensure that the requirements of the individual clients are taken into consideration. At the moment there are three versions of IGMP (V1 - V3); most current systems use V3, and less often V2.

Two packet types play a central role in IGMP: queries and reports.

Queries are only transmitted from a router. If several IGMP routers exist in a network, the router with the lowest IP address is the "querier". We differentiate here between a general query (sent to 224.0.0.1), a group-specific query (sent to a group address) and the group-and-source-specific query (sent to a specific group address). Reports are only sent by hosts to respond to queries.

### 17.2.1 IGMP

In this menu, you configure the interfaces on which IGMP is to be enabled.

#### 17.2.1.1 Edit or New

Choose the  icon to edit existing entries. Choose the **New** button to configure IGMP on other interfaces.

The **Multicast->IGMP->IGMP->New** menu consists of the following fields:

**Fields in the IGMP Settings menu.**

Field	Description
<b>Interface</b>	Select the interface on which IGMP is to be enabled, i.e. queries are sent and responses are accepted.
<b>Query Interval</b>	Enter the interval in seconds in which IGMP queries are to be sent.  Possible values are <i>0 to 600</i> .  The default value is <i>125</i> .
<b>Maximum Response Time</b>	For the sending of queries, enter the time interval in seconds within which hosts must respond. The hosts randomly select a time delay from this interval before sending the response. This spreads the load in networks with several hosts, improving performance.  Possible values are <i>0,0 to 25,0</i> .  The default value is <i>10,0</i> .
<b>Robustness</b>	Select the multiplier for controlling the timer values. A higher value can e.g. compensate for packet loss in a network susceptible to loss. If the value is too high, however, the time between logging off and stopping of the data traffic can be increased (leave latency).  Possible values are <i>2 to 8</i> .  The default value is <i>2</i> .
<b>Last Member Query Interval</b>	Define the time after a query for which the router waits for an answer.  If you shorten the interval, it will be more quickly detected that the last member has left a group so that no more packets for this group should be forwarded to this interface.  Possible values are <i>0,0 to 25,0</i> .  The default value is <i>1,0</i> .

Field	Description
<b>IGMP State Limit</b>	Limit the number of reports/queries per second for the selected interface.
<b>Mode</b>	Specify whether the interface defined here only works in host mode or in both host mode and routing mode.  Possible values: <ul style="list-style-type: none"> <li>• <i>Routing</i> (default value): The interface is operated in Routing mode.</li> <li>• <i>Host</i>: The interface is only operated in host mode.</li> </ul>

### IGMP Proxy

IGMP Proxy enables you to simulate several locally connected interfaces as a subnet to an adjacent router. Queries coming in to the IGMP Proxy interface are forwarded to the local subnets. Local reports are forwarded on the IPGM Proxy interface.

The menu **Advanced Settings** consists of the following fields:

#### Fields in the **Advanced Settings** menu.

Field	Description
<b>IGMP Proxy</b>	Select whether your device is to forward the hosts' IGMP messages in the subnet via its defined <b>Proxy Interface</b> .
<b>Proxy Interface</b>	Only for <b>IGMP Proxy</b> = enabled  Select the interface on your device via which queries are to be received and collected.
<b>Fallback Proxy Interface 1</b>	Only for <b>IGMP Proxy</b> = enabled  Select the fallback interface 1 on your device via which queries are to be received and collected. This interface will be used if the proxy function cannot be carried out on the <b>Proxy Interface</b> .
<b>Fallback Proxy Interface 2</b>	Only for <b>IGMP Proxy</b> = enabled  Select the fallback interface 2 on your device via which queries are to be received and collected. This interface will be used if the proxy function cannot be carried out on the <b>Fallback Proxy Interface 1</b> .

## 17.2.2 Options

In this menu, you can enable and disable IGMP on your system. You can also define whether IGMP is to be used in compatibility mode or only IGMP V3 hosts are to be accepted.

The **Multicast->IGMP->Options** menu consists of the following fields:

### Fields in the Basic Settings menu.

Field	Description
<b>IGMP Status</b>	<p>Select the IGMP status.</p> <p>Possible values:</p> <ul style="list-style-type: none"> <li>• <i>Auto</i> (default value): Multicast is activated automatically for hosts if the hosts open applications that use multicast.</li> <li>• <i>Up</i>: Multicast is always on.</li> <li>• <i>Down</i>: Multicast is always off.</li> </ul>
<b>Mode</b>	<p>Only for <b>IGMP Status</b> = <i>Up</i> or <i>Auto</i></p> <p>Select Multicast Mode.</p> <p>Possible values:</p> <ul style="list-style-type: none"> <li>• <i>Compatibility Mode</i> (default value): The router uses IGMP version 3. If it notices a lower version in the network, it uses the lowest version it could detect.</li> <li>• <i>Version 3 only</i>: Only IGMP version 3 is used.</li> </ul>
<b>Maximum Groups</b>	<p>Enter the maximum number of groups to be permitted, both internally and in reports.</p> <p>The default value is <i>64</i>.</p>
<b>Maximum Sources</b>	<p>Enter the maximum number of sources that are specified in version 3 reports and the maximum number of internally managed sources per group.</p> <p>The default value is <i>64</i>.</p>
<b>IGMP State Limit</b>	<p>Enter the maximum permitted total number of incoming queries and messages per second.</p>



Field	Description
	The default value is 0, i.e. the number of IGMP status messages is not limited.

## 17.3 Forwarding

### 17.3.1 Forwarding

In this menu, you specify which multicast groups are always passed between the interfaces of your device.

#### 17.3.1.1 New

Choose the **New** button to create forwarding rules for new multicast groups.

The **Multicast->Forwarding->Forwarding->New** menu consists of the following fields:

#### Fields in the Basic Parameters menu.

Field	Description
<b>All Multicast Groups</b>	Select whether all multicast groups, i.e. the complete multicast address range 224.0.0.0/4, are to be forwarded from the defined <b>Source Interface</b> to the defined <b>Destination Interface</b> . To do this, check <i>Enabled</i>  Disable the option if you only want to forward one defined multicast group to a particular interface.  The option is deactivated by default.
<b>Multicast Group Address</b>	Only for <b>All Multicast Groups</b> = not active.  Enter here the address of the multicast group you want to forward from a defined <b>Source Interface</b> to a defined <b>Destination Interface</b> .
<b>Source Interface</b>	Select the interface on your device to which the selected multicast group is sent.
<b>Destination Interface</b>	Select the interface on your device to which the selected multicast group is to be forwarded.

## Chapter 18 WAN

This menu offers various options for configuring accesses or connections from your LAN to the WAN. You can also optimise voice transmission here for telephone calls over the Internet.

### 18.1 Internet + Dialup

In this menu, you can set up Internet access or dialup connections.

In addition, you can create address pools for the dynamic assignment of IP addresses.

To enable your device to set up connections to networks or hosts outside your LAN, you must configure the partners you want to connect to on your device. This applies to outgoing connections (your device dials its WAN partner) and incoming connections (a remote partner dials the number of your device).

If you want to set up Internet access, you must set up a connection to your Internet Service Provider (ISP). For broadband Internet access, your device provides the PPP-over-Ethernet (PPPoE), PPP-over-PPTP and PPP-over-ATM (PPPoA) protocols.



#### Note



Note your provider's instructions.

Dialin connections over ISDN are used to establish a connection to networks or hosts outside your LANs.

All the entered connections are displayed in a list, which contains the **Description**, the **User Name**, the **Authentication** and the current **Status**.

The **Status** field can have the following values:

#### Possible values for Status

Field	Description
	connected
	not connected (dialup connection); connection setup possible
	not connected (e.g. because of an error during setup of an outgoing connection, a renewed attempt is only possible after a specified number of seconds)

Field	Description
	administratively set to down (deactivated); connection setup not possible

## 18.1.1 PPPoE

A list of all PPToE interfaces is displayed in the **WAN->Internet + Dialup->PPPoE** menu.

PPP over Ethernet (PPPoE) is the use of the Point-to-Point Protocol (PPP) network protocol over an Ethernet connection. Today, PPPoE is used for ADSL connections in Germany. In Austria, the Point To Point Tunnelling Protocol (PPTP) was originally used for ADSL access. However, PPPoE is now offered here too by some providers.

### 18.1.1.1 New

Choose the **New** button to set up new PPPoE interfaces.

The menu **WAN->Internet + Dialup->PPPoE->New** consists of the following fields:

#### Fields in the Basic Parameters menu.

Field	Description
<b>Description</b>	Enter a name to uniquely identify the PPPoE partner. The first character in this field must not be a number No special characters or umlauts must be used.
<b>PPPoE Mode</b>	<p>Select whether you want to use a standard Internet connection over PPPoE ( <i>Standard</i>) or your Internet access is to be set up over several interfaces ( <i>Multilink</i>). If you choose <i>Multilink</i>, you can connect several DSL connections from a provider over PPP as a static bundle in order to obtain more bandwidth. Each of these DSL connections should use a separate Ethernet connection for this. At the moment, many providers are still in the process of preparing the PPPoE Multilink function.</p> <p>For PPPoE Multilink, we recommend using your device's Ethernet switch in Split-Port mode and to use a separate Ethernet interface e.g. <i>en1-1</i>, <i>en1-2</i> for each PPPoE connection.</p> <p>If you also want to use an external modem for PPPoE Multilink, you must run your device's Ethernet switch in Split-Port mode.</p>
<b>PPPoE Ethernet Interface</b>	Only for <b>PPPoE Mode</b> = <i>Standard</i>

Field	Description
	<p>Select the Ethernet interface specified for a standard PPPoE connection.</p> <p>If you want to use an external DSL modem, select the Ethernet port to which the modem is connected.</p> <p>When using the internal DSL modem, select here the EthoA interface configured in <b>WAN-&gt;ATM-&gt;Profiles-&gt;New</b>.</p> <p>Select <i>Automatic</i> in order to enable the automatic VDSL/ADSL mode. In this mode, the interface for the Internet connection is selected automatically. Note that there has to be an interface entry in the <b>ATM</b> menu. This is not required for a VDSL connection.</p>
<b>PPPoE Interfaces for Multilink</b>	<p>Only for <b>PPPoE Mode</b> = <i>Multilink</i></p> <p>Select the interfaces you want to use for your Internet connection. Click the <b>Add</b> button to create new entries.</p>
<b>User Name</b>	Enter the user name.
<b>Password</b>	Enter the password.
<b>VLAN</b>	Certain Internet service providers require a VLAN-ID. Activate this function to be able to enter a value under <b>VLAN ID</b> .
<b>VLAN ID</b>	<p>Only if <b>VLAN</b> is enabled.</p> <p>Enter the VLAN-ID that you received from your provider.</p>
<b>Always on</b>	<p>Select whether the interface should always be activated.</p> <p>The function is enabled with <i>Enabled</i>.</p> <p>The function is disabled by default.</p> <p>Only activate this option if you have Internet access with a flat-rate charge.</p>
<b>Connection Idle Timeout</b>	<p>Only if <b>Always on</b> is disabled.</p> <p>Enter the idle time in seconds for static short hold. The static short hold setting determines how many seconds should pass between sending the last traffic data packet and clearing the</p>

Field	Description
	<p>connection.</p> <p>Possible values are <i>0</i> to <i>3600</i> (seconds). <i>0</i> deactivates the short hold.</p> <p>The default value is <i>300</i>.</p> <p>Example: <i>10</i> for FTP transmission, <i>20</i> for LAN-to-LAN transmission, <i>90</i> for Internet connections.</p>

#### Fields in the IPv4 Settings menu.

Field	Description
<b>Security Policy</b>	<p>Select the security settings to be used with the interface.</p> <p>Possible values:</p> <ul style="list-style-type: none"> <li>• <i>Trusted</i>: All IP packets are allowed through except for those which are explicitly prohibited.</li> <li>• <i>Untrusted</i> (default value): Only those packets are transmitted that can be attributed to a connection that has been initiated from a trusted zone.</li> </ul> <p>You can configure exceptions for the selected setting in the <a href="#">Firewall</a> on page 460 menu.</p>
<b>IP Address Mode</b>	<p>Select whether your device is to be assigned a static IP address or whether it should be assigned this dynamically.</p> <p>Possible values:</p> <ul style="list-style-type: none"> <li>• <i>Get IP Address</i> (default value): Your device is dynamically assigned an IP address.</li> <li>• <i>Static</i>: You enter a static IP address.</li> </ul>
<b>Default Route</b>	<p>Select whether the route to this connection partner is to be defined as the default route.</p> <p>The function is enabled with <i>Enabled</i>.</p> <p>The function is enabled by default.</p>
<b>Create NAT Policy</b>	<p>Specify whether Network Address Translation (NAT) is to be activated.</p>

Field	Description
	<p>The function is enabled with <i>Enabled</i>.</p> <p>The function is enabled by default.</p>
<b>Local IP Address</b>	<p>Only if <b>IP Address Mode</b> = <i>Static</i></p> <p>Enter the static IP address of the connection partner.</p>
<b>Route Entries</b>	<p>Only if <b>IP Address Mode</b> = <i>Static</i></p> <p>Define other routing entries for this connection partner.</p> <p>Add new entries with <b>Add</b>.</p> <ul style="list-style-type: none"> <li>• <i>Remote IP Address</i>: IP address of the destination host or network.</li> <li>• <i>Netmask</i>: Netmask for <b>Remote IP Address</b> If no entry is made, your device uses a default netmask.</li> <li>• <i>Metric</i>: The lower the value, the higher the priority of the route (range of values 0... 15). The default value is 1.</li> </ul>

#### Fields in the IPv6 Settings menu

Field	Description
<b>IPv6</b>	<p>Select whether the selected PPPoE interface should use Internet Protocol version 6 (IPv6) for data transmission.</p> <p>The function is activated by selecting <i>Enabled</i> .</p> <p>The function is disabled by default.</p>
<b>Security Policy</b>	<p>Select the security settings to be used with the interface.</p> <p>Possible values:</p> <ul style="list-style-type: none"> <li>• <i>Untrusted</i> (default value): Only those packets are transmitted that can be attributed to a connection that has been initiated from a trusted zone.</li> </ul> <p>We recommend you use this setting if you want to use IPv6 outside of your LAN.</p> <ul style="list-style-type: none"> <li>• <i>Trusted</i>: All IP packets are allowed through except for those which are explicitly prohibited.</li> </ul>

Field	Description
	<p>We recommend you use this setting if you want to use IPv6 on your LAN.</p> <p>You can configure exceptions for the selected setting in the <a href="#">Firewall</a> on page 460 menu.</p>
<b>IPv6 Mode</b>	<p>Only for <b>IPv6</b> = <i>Enabled</i></p> <p>The selected PPPoE interface is operated in host mode.</p>
<b>Accept Router Advertisement</b>	<p>Only for <b>IPv6</b> = <i>Enabled</i> and <b>IPv6 Mode</b> = <i>Host</i></p> <p>Select if Router Advertisements are to be received on the selected interface. Router Advertisements are used, e.g., to create the prefix list.</p> <p>The function is activated by selecting <i>Enabled</i> .</p> <p>The function is enabled by default.</p>
<b>DHCP Client</b>	<p>Only for <b>IPv6</b> = <i>Enabled</i> and <b>IPv6 Mode</b> = <i>Host</i></p> <p>Determine if your device is to act as DHCP client.</p> <p>The function is activated by selecting <i>Enabled</i> .</p> <p>The function is enabled by default.</p>

The menu **Advanced Settings** consists of the following fields:

#### Fields in the **Advanced Settings** menu.

Field	Description
<b>Block after connection failure for</b>	<p>Enter the wait time in seconds before the device should try again after an attempt to set up a connection has failed. The default value is <i>60</i>.</p>
<b>Maximum Number of Dialup Retries</b>	<p>Enter the number of unsuccessful attempts to setup a connection before the interface is blocked.</p> <p>Possible values are <i>0</i> to <i>100</i>.</p> <p>The default value is <i>5</i>.</p>
<b>Authentication</b>	<p>Select the authentication protocol for this connection partner.</p>

Field	Description
	<p>Select the authentication specified by your provider.</p> <p>Possible values:</p> <ul style="list-style-type: none"> <li>• <i>PAP</i> (default value): Only run PAP (PPP Password Authentication Protocol); the password is transferred unencrypted.</li> <li>• <i>CHAP</i>: Only run CHAP (PPP Challenge Handshake Authentication Protocol as per RFC 1994); password is transferred encrypted.</li> <li>• <i>PAP/CHAP</i>: Primarily run CHAP, otherwise PAP.</li> <li>• <i>MS-CHAPv1</i>: Only run MS-CHAP version 1 (PPP Microsoft Challenge Handshake Authentication Protocol).</li> <li>• <i>PAP/CHAP/MS-CHAP</i>: Primarily run CHAP, on denial then the authentication protocol required by the connection partner. (MSCHAP version 1 or 2 possible.)</li> <li>• <i>MS-CHAPv2</i>: Run MS-CHAP version 2 only.</li> <li>• <i>None</i>: Some providers use no authentication. In this case, select this option.</li> </ul>
<b>DNS Negotiation</b>	<p>Select whether your device receives IP addresses for <b>Primary DNS Server</b> and <b>Secondary DNS Server</b> from the connection partner or sends these to the connection partner.</p> <p>The function is enabled with <i>Enabled</i>.</p> <p>The function is enabled by default.</p>
<b>Prioritize TCP ACK Packets</b>	<p>Select whether the TCP download is to be optimised in the event of intensive TCP upload. This function can be specially applied for asymmetrical bandwidths (ADSL).</p> <p>The function is enabled with <i>Enabled</i>.</p> <p>The function is disabled by default.</p>
<b>LCP Alive Check</b>	<p>Select whether the availability of the remote terminal is to be checked by sending LCP echo requests or replies. This makes it possible to switch to a backup connection more quickly in the event of line faults.</p> <p>The function is enabled with <i>Enabled</i>.</p> <p>The function is enabled by default.</p>



### Fields in the IPv4 Advanced Settings menu

Field	Description
<b>MTU</b>	<p>Enter the maximum packet size (Maximum Transfer Unit, MTU) in bytes that is allowed for the connection.</p> <p>With default value <i>Automatic</i>, the value is specified by link control at connection setup.</p> <p>If you disable <i>Automatic</i>, you can enter a value.</p> <p>Possible values are <i>1</i> to <i>8192</i>.</p> <p>The default value is <i>0</i>.</p>

## 18.1.2 PPTP

A list of all PPTP interfaces is displayed in the **WAN->Internet + Dialup->PPTP** menu.

In this menu, you configure an Internet connection that uses the Point Tunneling Protocol (PPTP) to set up a connection. This is required in Austria, for example.

### 18.1.2.1 New

Choose the **New** button to set up new PPTP interfaces.

The menu **WAN->Internet + Dialup->PPTP->New** consists of the following fields:

#### Fields in the Basic Parameters menu.

Field	Description
<b>Description</b>	<p>Enter a name for uniquely identifying the internet connection.</p> <p>The first character in this field must not be a number No special characters or umlauts must be used.</p>
<b>PPTP Ethernet Interface</b>	<p>Select the IP interface over which packets are to be transported to the remote PPTP terminal.</p> <p>If you want to use an external DSL modem, select the Ethernet port to which the modem is connected.</p> <p>When using the internal DSL modem, select here the EthoA interface configured in <b>Physical Interfaces-&gt;ATM-&gt;Profiles-&gt;New</b>, e.g. <i>ethoa50-0</i>.</p>

Field	Description
<b>User Name</b>	Enter the user name.
<b>Password</b>	Enter the password.
<b>Always on</b>	<p>Select whether the interface should always be activated.</p> <p>The function is enabled with <i>Enabled</i>.</p> <p>The function is disabled by default.</p> <p>Only activate this option if you have Internet access with a flat-rate charge.</p>
<b>Connection Idle Timeout</b>	<p>Only if <b>Always on</b> is disabled.</p> <p>Enter the idle interval in seconds. This determines how many seconds should pass between sending the last traffic data packet and clearing the connection.</p> <p>Possible values are <i>0</i> to <i>3600</i> (seconds). <i>0</i> deactivates the timeout.</p> <p>The default value is <i>300</i>.</p> <p>Example: <i>10</i> for FTP transmission, <i>20</i> for LAN-to-LAN transmission, <i>90</i> for Internet connections.</p>

#### Fields in the IPv4 Settings menu.

Field	Description
<b>Security Policy</b>	<p>Select the security settings to be used with the interface.</p> <p>Possible values:</p> <ul style="list-style-type: none"> <li>• <i>Trusted</i>: All IP packets are allowed through except for those which are explicitly prohibited..</li> <li>• <i>Untrusted</i> (default value): Only those packets are transmitted that can be attributed to a connection that has been initiated from a trusted zone.</li> </ul> <p>You can configure exceptions for the selected setting in the <a href="#">Firewall</a> on page 460 menu.</p>
<b>IP Address Mode</b>	Select whether your device is to be assigned a static IP address

Field	Description
	<p>or whether it should be assigned this dynamically.</p> <p>Possible values:</p> <ul style="list-style-type: none"> <li>• <i>Get IP Address</i> (default value): Your device is automatically assigned a temporarily valid IP address from the provider.</li> <li>• <i>Static</i> : You enter a static IP address.</li> </ul>
<b>Default Route</b>	<p>Select whether the route to this connection partner is to be defined as the default route.</p> <p>The function is enabled with <i>Enabled</i>.</p> <p>The function is enabled by default.</p>
<b>Create NAT Policy</b>	<p>Specify whether Network Address Translation (NAT) is to be activated.</p> <p>The function is enabled with <i>Enabled</i>.</p> <p>The function is enabled by default.</p>
<b>Local IP Address</b>	<p>Only for <b>IP Address Mode</b> = <i>Static</i></p> <p>Assign an IP address from your LAN to the PPT interface, which is to be used as your device's internal source address.</p>
<b>Route Entries</b>	<p>Only if <b>IP Address Mode</b> = <i>Static</i></p> <p>Define other routing entries for this PPTP partner.</p> <p>Add new entries with <b>Add</b>.</p> <ul style="list-style-type: none"> <li>• <i>Remote IP Address</i>: IP address of the destination host or network.</li> <li>• <i>Netmask</i>: Netmask for <b>Remote IP Address</b> If no entry is made, your device uses a default netmask.</li> <li>• <i>Metric</i>: The lower the value, the higher the priority of the route (range of values 0... 15). The default value is 1.</li> </ul>

The menu **Advanced Settings** consists of the following fields:

**Fields in the Advanced Settings menu.**

Field	Description
<b>Block after connection failure for</b>	Enter the wait time in seconds before the device should try again after an attempt to set up a connection has failed. The default value is <i>60</i> .
<b>Maximum Number of Dialup Retries</b>	Enter the number of unsuccessful attempts to setup a connection before the interface is blocked.  Possible values are <i>0</i> to <i>100</i> .  The default value is <i>5</i> .
<b>Authentication</b>	Select the authentication protocol for this Internet connection. Select the authentication specified by your provider.  Possible values: <ul style="list-style-type: none"> <li>• <i>PAP</i> (default value): Only run PAP (PPP Password Authentication Protocol); the password is transferred unencrypted.</li> <li>• <i>CHAP</i>: Only run CHAP (PPP Challenge Handshake Authentication Protocol as per RFC 1994); password is transferred encrypted.</li> <li>• <i>PAP/CHAP</i>: Primarily run CHAP, otherwise PAP.</li> <li>• <i>MS-CHAPv1</i>: Only run MS-CHAP version 1 (PPP Microsoft Challenge Handshake Authentication Protocol).</li> <li>• <i>PAP/CHAP/MS-CHAP</i>: Primarily run CHAP, on denial then the authentication protocol required by the connection partner. (MSCHAP version 1 or 2 possible.)</li> <li>• <i>MS-CHAPv2</i>: Run MS-CHAP version 2 only.</li> <li>• <i>None</i>: Some providers use no authentication. In this case, select this option.</li> </ul>
<b>DNS Negotiation</b>	Select whether your device receives IP addresses for <b>Primary DNS Server</b> and <b>Secondary DNS Server</b> from the connection partner or sends these to the connection partner.  The function is enabled with <i>Enabled</i> .  The function is enabled by default.
<b>Prioritize TCP ACK Packets</b>	Select whether the TCP download is to be optimised in the event of intensive TCP upload. This function can be specially applied for asymmetrical bandwidths (ADSL).

Field	Description
	<p>The function is enabled with <i>Enabled</i>.</p> <p>The function is disabled by default.</p>
<b>PPTP Address Mode</b>	<p>Displays the address mode. The value cannot be changed.</p> <p>Possible values:</p> <ul style="list-style-type: none"> <li>• <i>Static</i>: The <b>Local PPTP IP Address</b> will be assigned to the selected Ethernet port.</li> </ul>
<b>Local PPTP IP Address</b>	<p>Assign the PPTP interface an IP address that is used as the source address.</p> <p>The default value is <i>10.0.0.140</i>.</p>
<b>Remote PPTP IP Address</b>	<p>Enter the IP address of the PPTP partner.</p> <p>The default value is <i>10.0.0.138</i>.</p>
<b>LCP Alive Check</b>	<p>Select whether the availability of the remote terminal is to be checked by sending LCP echo requests or replies. This makes it possible to switch to a backup connection more quickly in the event of line faults.</p> <p>The function is enabled with <i>Enabled</i>.</p> <p>The function is enabled by default.</p>

### 18.1.3 PPPoA

A list of all PPPoA interfaces is displayed in the **WAN->Internet + Dialup->PPPoA** menu.

In this menu, you configure a xDSL connection used to set up PPPoA connections. With PPPoA, the connection is configured so that the PPP data flow is transported directly over an ATM network (RFC 2364). This is required by some providers. Note your provider's specifications.

When using the internal DSL modem, a PPPoA interface must be configured with **Client Type = On Demand** for this connection in **WAN->ATM->Profiles->New**.

#### 18.1.3.1 New

Choose the **New** button to set up new PPPoA interfaces.

The menu **WAN->Internet + Dialup->PPPoA->New** consists of the following fields:

#### Fields in the **Basic Parameters** menu.

Field	Description
<b>Description</b>	Enter a name for uniquely identifying the connection partner. The first character in this field must not be a number. No special characters or umlauts must be used.
<b>ATM PVC</b>	Select an ATM profile created in the <b>ATM-&gt;Profiles</b> menu, indicated by the global identifiers VPI and VCI specified by the provider.
<b>User Name</b>	Enter the user name.
<b>Password</b>	Enter the password for the PPPoA connection.
<b>Always on</b>	Select whether the interface should always be activated.  The function is enabled with <i>Enabled</i> .  The function is disabled by default.  Only activate this option if you have Internet access with a flat-rate charge.
<b>Connection Idle Timeout</b>	Only if <b>Always on</b> is disabled.  Enter the idle time in seconds for static short hold. The static short hold setting determines how many seconds should pass between sending the last traffic data packet and clearing the connection.  Possible values are <i>0</i> to <i>3600</i> (seconds). <i>0</i> deactivates the short hold.  The default value is <i>300</i> .  Example: <i>10</i> for FTP transmission, <i>20</i> for LAN-to-LAN transmission, <i>90</i> for Internet connections.

#### Fields in the **IPv4 Settings** menu.

Field	Description
<b>Security Policy</b>	Select the security settings to be used with the interface.

Field	Description
	<p>Possible values:</p> <ul style="list-style-type: none"> <li>• <i>Trusted</i> : All IP packets are allowed through except for those which are explicitly prohibited..</li> <li>• <i>Untrusted</i> (default value): Only those packets are transmitted that can be attributed to a connection that has been initiated from a trusted zone.</li> </ul> <p>You can configure exceptions for the selected setting in the <a href="#">Firewall</a> on page 460 menu.</p>
<b>IP Address Mode</b>	<p>Choose whether your device has a static IP address or is assigned one dynamically.</p> <p>Possible values:</p> <ul style="list-style-type: none"> <li>• <i>Get IP Address</i> (default value): Your device is dynamically assigned an IP address.</li> <li>• <i>Static</i>: You enter a static IP address.</li> </ul>
<b>Default Route</b>	<p>Select whether the route to this connection partner is to be defined as the default route.</p> <p>The function is enabled with <i>Enabled</i>.</p> <p>The function is enabled by default.</p>
<b>Create NAT Policy</b>	<p>Specify whether Network Address Translation (NAT) is to be activated.</p> <p>The function is enabled with <i>Enabled</i>.</p> <p>The function is enabled by default.</p>
<b>Local IP Address</b>	<p>Only for <b>IP Address Mode</b> = <i>Static</i></p> <p>Enter the static IP address you received from your provider.</p>
<b>Route Entries</b>	<p>Only if <b>IP Address Mode</b> = <i>Static</i></p> <p>Define other routing entries for this connection partner.</p> <p>Add new entries with <b>Add</b>.</p> <ul style="list-style-type: none"> <li>• <i>Remote IP Address</i>: IP address of the destination host or</li> </ul>

Field	Description
	<p>network.</p> <ul style="list-style-type: none"> <li>• <i>Netmask</i>: Netmask for <b>Remote IP Address</b>. If no entry is made, your device uses a default netmask.</li> <li>• <i>Metric</i>: The lower the value, the higher the priority of the route (range of values 0... 15). The default value is 1.</li> </ul>

#### Fields in the IPv6 Settings menu

Field	Description
<b>IPv6</b>	<p>Select whether the selected ATM profile should use Internet Protocol version 6 (IPv6) for data transmission.</p> <p>The function is activated by selecting <i>Enabled</i> .</p> <p>The function is disabled by default.</p>
<b>Security Policy</b>	<p>Select the security settings to be used with the ATM profile.</p> <p>Possible values:</p> <ul style="list-style-type: none"> <li>• <i>Untrusted</i> (default value): Only those packets are transmitted that can be attributed to a connection that has been initiated from a trusted zone.</li> </ul> <p>We recommend you use this setting if you want to use IPv6 outside of your LAN.</p> <ul style="list-style-type: none"> <li>• <i>Trusted</i>: All IP packets are allowed through except for those which are explicitly prohibited.</li> </ul> <p>We recommend you use this setting if you want to use IPv6 on your LAN.</p> <p>You can configure exceptions for the selected setting in the <a href="#">Firewall</a> on page 460 menu.</p>
<b>IPv6 Mode</b>	<p>Only for <b>IPv6</b> = <i>Enabled</i></p> <p>The selected PPPoE interface is operated in host mode.</p>
<b>Accept Router Advertisement</b>	<p>Only for <b>IPv6</b> = <i>Enabled</i> and <b>IPv6 Mode</b> = <i>Host</i></p> <p>Determine if Router Advertisements are to be received over this ATM profile. Router Advertisements are used to create the default router list as well as the prefix list.</p>



Field	Description
	<p>The function is activated by selecting <i>Enabled</i> .</p> <p>The function is enabled by default.</p>
<b>DHCP Client</b>	<p>Only for <b>IPv6</b> = <i>Enabled</i> and <b>IPv6 Mode</b> = <i>Host</i></p> <p>Determine if your device is to act as DHCP client.</p> <p>The function is activated by selecting <i>Enabled</i> .</p> <p>The function is enabled by default.</p>

The menu **Advanced Settings** consists of the following fields:

#### Fields in the **Advanced Settings** menu.

Field	Description
<b>Block after connection failure for</b>	<p>Enter the wait time in seconds before the device should try again after an attempt to set up a connection has failed. The default value is <i>60</i>.</p>
<b>Maximum Number of Dialup Retries</b>	<p>Enter the number of unsuccessful attempts to setup a connection before the interface is blocked.</p> <p>Possible values are <i>0</i> to <i>100</i>.</p> <p>The default value is <i>5</i>.</p>
<b>Authentication</b>	<p>Select the authentication protocol for this Internet connection. Select the authentication specified by your provider.</p> <p>Possible values:</p> <ul style="list-style-type: none"> <li>• <i>PAP</i> (default value): Only run PAP (PPP Password Authentication Protocol); the password is transferred unencrypted.</li> <li>• <i>CHAP</i>: Only run CHAP (PPP Challenge Handshake Authentication Protocol as per RFC 1994); password is transferred encrypted.</li> <li>• <i>PAP/CHAP</i>: Primarily run CHAP, otherwise PAP.</li> <li>• <i>MS-CHAPv1</i>: Only run MS-CHAP version 1 (PPP Microsoft Challenge Handshake Authentication Protocol).</li> <li>• <i>PAP/CHAP/MS-CHAP</i>: Primarily run CHAP, on denial then the authentication protocol required by the connection partner.</li> </ul>

Field	Description
	<p>(MSCHAP version 1 or 2 possible.)</p> <ul style="list-style-type: none"> <li>• <i>MS-CHAPv2</i>: Run MS-CHAP version 2 only.</li> <li>• <i>None</i>: Some providers use no authentication. In this case, select this option.</li> </ul>
<b>DNS Negotiation</b>	<p>Select whether your device receives IP addresses for <b>Primary DNS Server</b> and <b>Secondary DNS Server</b> from the connection partner or sends these to the connection partner.</p> <p>The function is enabled with <i>Enabled</i>.</p> <p>The function is enabled by default.</p>
<b>Prioritize TCP ACK Packets</b>	<p>Select whether the TCP download is to be optimised in the event of intensive TCP upload. This function can be specially applied for asymmetrical bandwidths (ADSL).</p> <p>The function is enabled with <i>Enabled</i>.</p> <p>The function is disabled by default.</p>
<b>LCP Alive Check</b>	<p>Select whether the availability of the remote terminal is to be checked by sending LCP echo requests or replies. This is recommended for leased lines, PPTP and L2TP connections.</p> <p>The function is enabled with <i>Enabled</i>.</p> <p>The function is enabled by default.</p>

## 18.1.4 ISDN

A list of all ISDN interfaces in TE mode (ISDN extern) is displayed in the **WAN->Internet + Dialup->ISDN** menu.

In this menu, you configure the following ISDN connections:

- Internet access over ISDN
- LAN to LAN connection over ISDN
- Remote (Mobile) dial-in
- Use of the ISDN Callback function

### 18.1.4.1 New

Choose the **New** button to set up new ISDN interfaces.

The menu **WAN->Internet + Dialup->ISDN->New** consists of the following fields:

#### Fields in the **Basic Parameters** menu.

Field	Description
<b>Description</b>	<p>Enter a name for uniquely identifying the connection partner.</p> <p>The first character in this field must not be a number No special characters or umlauts must be used.</p>
<b>Connection Type</b>	<p>Select which layer 1 protocol your device should use.</p> <p>This setting applies for outgoing connections to the connection partner and only for incoming connections from the connection partner if they could be identified on the basis of the calling party number.</p> <p>Possible values:</p> <ul style="list-style-type: none"> <li>• <i>ISDN 64 kbps</i>: For 64-kbps ISDN data connections.</li> <li>• <i>ISDN 56 kbps</i>: For 56-kbps ISDN data connections.</li> </ul>
<b>User Name</b>	Enter your device code (local PPP user name).
<b>Remote User (for Dial-in only)</b>	Enter the code of the remote terminal (remote PPP user name).
<b>Password</b>	Enter the password.
<b>Always on</b>	<p>Select whether the interface should always be activated.</p> <p>The function is enabled with <i>Enabled</i>.</p> <p>The function is disabled by default.</p> <p>Only activate this option if you have Internet access with a flat-rate charge.</p>
<b>Connection Idle Timeout</b>	<p>Only if <b>Always on</b> is disabled.</p> <p>Enter the idle interval in seconds. This determines how many</p>

Field	Description
	<p>seconds should pass between sending the last traffic data packet and clearing the connection.</p> <p>Possible values are <i>0</i> to <i>3600</i> (seconds). <i>0</i> deactivates the timeout. The default value is <i>20</i>.</p>

#### Fields in the **IP Mode and Routes** menu.

Field	Description
<b>IP Address Mode</b>	<p>Select whether your device is to be assigned a static IP address or whether it should be assigned this dynamically.</p> <p>Possible values:</p> <ul style="list-style-type: none"> <li>• <i>Static</i> (default value): You enter a static IP address.</li> <li>• <i>Provide IP Address</i>: Your device dynamically assigns an IP address to the remote terminal.</li> <li>• <i>Get IP Address</i>: Your device is dynamically assigned an IP address.</li> </ul>
<b>Default Route</b>	<p>Only for <b>IP Address Mode</b> = <i>Static</i> and <i>Get IP Address</i></p> <p>Select whether the route to this connection partner is to be defined as the default route.</p> <p>The function is enabled with <i>Enabled</i>.</p> <p>The function is disabled by default.</p>
<b>Create NAT Policy</b>	<p>Only for <b>IP Address Mode</b> = <i>Static</i> and <i>Get IP Address</i></p> <p>When you configure an ISDN Internet connection, specify whether Network Address Translation (NAT) is to be activated.</p> <p>The function is enabled with <i>Enabled</i>.</p> <p>The function is disabled by default.</p>
<b>Local IP Address</b>	<p>Only if <b>IP Address Mode</b> = <i>Static</i></p> <p>Assign the IP address from your LAN to the ISDN interface which is to be used as your device's internal source address.</p>
<b>Route Entries</b>	<p>Only if <b>IP Address Mode</b> = <i>Static</i></p>

Field	Description
	<p>Define other routing entries for this connection partner.</p> <ul style="list-style-type: none"> <li>• <i>Remote IP Address</i>: IP address of the destination host or network.</li> <li>• <i>Netmask</i>: Netmask for <b>Remote IP Address</b>. If no entry is made, your device uses a default netmask.</li> <li>• <i>Metric</i>: The lower the value, the higher the priority of the route (range of values 0... 15). The default value is 1.</li> </ul>
<b>IP Assignment Pool</b>	<p>Only if <b>IP Address Mode</b> = <i>Provide IP Address</i></p> <p>Select IP pools configured in the <b>WAN-&gt;Internet + Dialup-&gt;IP Pools</b> menu. If an IP pool has not been configured here yet, the message <i>Not yet defined</i> appears in this field.</p>

The menu **Advanced Settings** consists of the following fields:

#### Fields in the **Advanced Settings** menu.

Field	Description
<b>Block after connection failure for</b>	<p>Enter the wait time in seconds before the device should try again after an attempt to set up a connection has failed.</p> <p>The default value is 300.</p>
<b>Maximum Number of Dialup Retries</b>	<p>Enter the number of unsuccessful attempts to setup a connection before the interface is blocked.</p> <p>Possible values are 0 to 100.</p> <p>The default value is 5.</p>
<b>Usage Type</b>	<p>If necessary, select a special interface use.</p> <p>Possible values:</p> <ul style="list-style-type: none"> <li>• <i>Standard</i> (default value): No special type is selected.</li> <li>• <i>Dialin only</i>: The interface is used for incoming dialup connections and callbacks initiated externally.</li> <li>• <i>Multi-User (Dialin only)</i>: The interface is defined as multi-user connection partner, i.e. several clients dial in with the same user name and password.</li> </ul>

Field	Description
<b>Authentication</b>	<p>Select the authentication protocol for this PPTP partner.</p> <p>Possible values:</p> <ul style="list-style-type: none"> <li>• <i>PAP</i> (default value): Only run PAP (PPP Password Authentication Protocol); the password is transferred unencrypted.</li> <li>• <i>CHAP</i>: Only run CHAP (PPP Challenge Handshake Authentication Protocol as per RFC 1994); password is transferred encrypted.</li> <li>• <i>PAP/CHAP</i>: Primarily run CHAP, otherwise PAP.</li> <li>• <i>MS-CHAPv1</i>: Only run MS-CHAP version 1 (PPP Microsoft Challenge Handshake Authentication Protocol).</li> <li>• <i>PAP/CHAP/MS-CHAP</i>: Primarily run CHAP, on denial then the authentication protocol required by the connection partner. (MSCHAP version 1 or 2 possible.)</li> <li>• <i>MS-CHAPv2</i>: Run MS-CHAP version 2 only.</li> <li>• <i>None</i>: Some providers use no authentication. In this case, select this option.</li> </ul>
<b>Encryption</b>	<p>Only for <b>Authentication</b> = <i>MS-CHAPv2</i></p> <p>If necessary, select the type of encryption that should be used for data traffic to the connection partner. This is only possible if STAC or MS-STAC compression is not activated for the connection. If <b>Encryption</b> is set, the remote terminal must also support it, otherwise a connection cannot be set up.</p> <p>Possible values:</p> <ul style="list-style-type: none"> <li>• <i>None</i> (default value): MPP encryption is not used.</li> <li>• <i>Enabled</i>: MPP encryption V2 with 128 bit is used to RFC 3078.</li> <li>• <i>Windows compatible</i>: MPP encryption V2 with 128 bit is used as compatible with Microsoft and Cisco.</li> </ul>
<b>Callback Mode</b>	<p>Select the Callback Mode function.</p> <p>Possible values:</p> <ul style="list-style-type: none"> <li>• <i>None</i> (default value): Your device does not call back.</li> <li>• <i>Active</i>: Select one of the following options:</li> </ul>

Field	Description
	<ul style="list-style-type: none"> <li>• <i>No PPP negotiation</i>: Your device calls the connection partner to request a callback.</li> <li>• <i>Windows Client Mode</i>: Your device calls the connection partner to request a callback via CBCP (Callback Control Protocol). Needed for Windows clients.</li> <li>• <i>Passive</i>: Select one of the following options: <ul style="list-style-type: none"> <li>• <i>PPP Negotiation or CLID</i>: Your device calls back immediately when requested to do so by the connection partner.</li> <li>• <i>Windows Server Mode</i>: Your device calls back after a period of time suggested by the Microsoft client (NT: 10 seconds, new systems: 12 seconds. It uses the call number (<b>Entries-&gt;Call Number</b>) with the <b>Mode</b> <i>Outgoing</i> or <i>Both</i> entered for the connection partner. If no number is entered, the required number can be reported by the caller in a PPP negotiation. This setting should be avoided where possible for security reasons. At present, this cannot be avoided when connecting mobile Microsoft clients via a DCN.</li> <li>• <i>Delayed, CLID only</i>: Your device calls back after approx. four seconds if your device is requested to do so by the connection partner. Only makes sense for CLID.</li> <li>• <i>Windows Server Mode, Callback optional</i>: like <i>Windows Server Mode</i> with the option of termination. This setting should be avoided for security reasons. The Microsoft client also has the option of aborting callback and maintaining the initial connection to your device without callback. This only applies if no fixed, outgoing number has been configured for the connection partner. This is done by closing the dialog box that appears with <b>Cancel</b>.</li> </ul> </li> </ul>

#### Fields in the **Bandwith on Demand Options** menu.

Field	Description
<b>Channel Bundling</b>	<p>Select whether channel bundling is to be used for ISDN connections with the connection partner, and if so, what type.</p> <p>Your device supports dynamic and static channel bundling for dialup connections. Only one B-channel is initially opened when a connection is set up. Dynamic channel bundling means that</p>

Field	Description
	<p>your device connects other ISDN B channels to increase the throughput for connections if this is required, e.g. for large data rates. If the amount of data traffic drops, the additional B-channels are closed again. In static channel bundling, you specify right from the start how many B-channels your device is to use, regardless of the transferred data rate.</p> <p>Possible values:</p> <ul style="list-style-type: none"> <li>• <i>None</i> (default value): No channel bundling, only one B-channel is ever available for connections.</li> <li>• <i>Static</i>: Static channel bundling.</li> <li>• <i>Dynamic</i>: Dynamic channel bundling.</li> </ul>

#### Fields in the **Dial Numbers** menu

Field	Description
<b>Entries</b>	Add new entries with <b>Add</b> .

#### Fields in menu **Dial Number Configuration** (appears only for **Entries = Add**)

Field	Description
<b>Mode</b>	<p>Only if <b>Entries = Add</b></p> <p>The calling party number of the call is compared with the number entered under <b>Call Number</b>. Defines whether <b>Call Number</b> should be used for incoming or outgoing calls or for both. Possible values:</p> <ul style="list-style-type: none"> <li>• <i>Both</i> (default value): For incoming and outgoing calls.</li> <li>• <i>Incoming</i>: For incoming calls, where your connection partner dials in to your device.</li> <li>• <i>Outgoing</i>: For outgoing calls, where you dial your connection partner.</li> </ul> <p>The calling party number of the incoming call is compared with the number entered under <b>Call Number</b>.</p>
<b>Call Number</b>	Enter the connection partner's numbers.
<b>Number of Used Ports</b>	Select which port is used.

#### Fields in the **IP Options** menu.



Field	Description
<b>OSPF Mode</b>	<p>Select whether and how routes are propagated via the interface and/or OSPF protocol packets are sent.</p> <p>Possible values:</p> <ul style="list-style-type: none"> <li>• <i>Passive</i> (default value): OSPF is not activated for this interface, i.e. no routes are propagated or OSPF protocol packets sent over this interface. Networks reachable over this interface are, however, included when calculating the routing information and propagated over active interfaces.</li> <li>• <i>Active</i>: OSPF is activated for this interface, i.e. routes are propagated or OSPF protocol packets sent over this interface.</li> <li>• <i>Inactive</i>: OSPF is disabled for this interface.</li> </ul>
<b>Proxy ARP Mode</b>	<p>Select whether and how ARP requests from your own LAN are to be responded to for the specified connection partner.</p> <p>Possible values:</p> <ul style="list-style-type: none"> <li>• <i>Inactive</i> (default value): Deactivates Proxy ARP for this connection partner.</li> <li>• <i>Up or Dormant</i>: Your device only responds to an ARP request if the status of the connection to the connection partner is <i>Up</i> or <i>Dormant</i>. In the case of <i>Dormant</i>, your device only responds to the ARP request; the connection is not set up until someone actually wants to use the route.</li> <li>• <i>Up only</i>: Your device responds to an ARP request only if the status of the connection to the connection partner is <i>Up</i>, i.e. a connection already exists to the connection partner.</li> </ul>
<b>DNS Negotiation</b>	<p>Select whether your device receives IP addresses for <b>Primary DNS Server</b> and <b>Secondary DNS Server</b> and <b>WINS Server Primary</b> and <b>Secondary</b> from the connection partner or sends these to the connection partner.</p> <p>The function is enabled with <i>Enabled</i>.</p> <p>The function is enabled by default.</p>

## 18.1.5 UMTS/LTE



### Note

Please note that the **UMTS/LTE** menu is only available for devices with an integrated UMTS/HSDPA modem, or with devices supporting the use of a UMTS/HSDPA/LTE USB stick!

A list of all configured GPRS/UMTS/LTE connections is displayed in the **WAN->Internet + Dialup->UMTS/LTE** menu.

With mobile standards GPRS, UMTS and LTE, you can establish an internet connection via the mobile network.

### 18.1.5.1 New

Choose the **New** button to create additional connections.

The **WAN->Internet + Dialup->UMTS/LTE->New** menu consists of the following fields:

#### Fields in the **Basic Parameters** menu.

Field	Description
<b>Description</b>	Enter a name for uniquely identifying the internet connection. The first character in this field must not be a number No special characters or umlauts must be used.
<b>UMTS/LTE Interface</b>	Select the UMTS/LTE interface. In <b>RS120wu</b> the integrated modem with slot 6 unit 0 UMTS is preselected; for devices with an optional plug-in UMTS/LTE stick the USB port of the device is preselected.
<b>User Name</b>	Enter the user name.
<b>Password</b>	Enter the password.
<b>Always on</b>	Select whether the interface should always be activated.  The function is enabled with <i>Enabled</i> .  The function is disabled by default.  Only activate this option if you have Internet access with a flat-rate charge.

Field	Description
<b>Connection Idle Timeout</b>	<p>Only if <b>Always on</b> is disabled.</p> <p>Enter the idle time in seconds for static short hold. The static short hold setting determines how many seconds should pass between sending the last traffic data packet and clearing the connection.</p> <p>Possible values are 0 to 3600 (seconds). 0 deactivates the short hold.</p> <p>The default value is 300.</p>

#### Fields in the IP Mode and Routes menu.

Field	Description
<b>IP Address Mode</b>	<p>Select whether your device is to be assigned a static IP address or whether it should be assigned this dynamically.</p> <p>Possible values:</p> <ul style="list-style-type: none"> <li>• <i>Get IP Address</i> (default value): Your device is dynamically assigned an IP address.</li> <li>• <i>Static</i>: You enter a static IP address.</li> </ul>
<b>Default Route</b>	<p>Select whether the route to this connection partner is to be defined as the default route.</p> <p>The function is enabled with <i>Enabled</i>.</p> <p>The function is enabled by default.</p>
<b>Create NAT Policy</b>	<p>Specify whether Network Address Translation (NAT) is to be activated.</p> <p>The function is enabled with <i>Enabled</i>.</p> <p>The function is enabled by default.</p>
<b>Local IP Address</b>	<p>Only if <b>IP Address Mode</b> = <i>Static</i></p> <p>Enter the static IP address of the connection partner.</p>
<b>Route Entries</b>	<p>Only if <b>IP Address Mode</b> = <i>Static</i></p> <p>Define other routing entries for this connection partner.</p>

Field	Description
	<p>Add new entries with <b>Add</b>.</p> <ul style="list-style-type: none"> <li>• <i>Remote IP Address</i>: IP address of the destination host or network.</li> <li>• <i>Netmask</i>: Netmask for <b>Remote IP Address</b>. If no entry is made, your device uses a default netmask.</li> <li>• <i>Metric</i>: The lower the value, the higher the priority of the route (range of values <i>0... 15</i>). The default value is <i>1</i>.</li> </ul>

The menu **Advanced Settings** consists of the following fields:

#### Fields in the **Advanced Settings** menu.

Field	Description
<b>Block after connection failure for</b>	Enter the wait time in seconds before the device should try again after an attempt to set up a connection has failed. The default value is <i>60</i> .
<b>Maximum Number of Dialup Retries</b>	Enter the number of unsuccessful attempts to setup a connection before the interface is blocked.  Possible values are <i>0</i> to <i>100</i> .  The default value is <i>5</i> .
<b>Authentication</b>	<p>Select the authentication protocol for this connection partner. Select the authentication specified by your provider.</p> <p>Possible values:</p> <ul style="list-style-type: none"> <li>• <i>PAP</i> (default value): Only run <i>PAP</i> (PPP Password Authentication Protocol); the password is transferred unencrypted.</li> <li>• <i>CHAP</i>: Only run <i>CHAP</i> (PPP Challenge Handshake Authentication Protocol as per RFC 1994); password is transferred encrypted.</li> <li>• <i>PAP/CHAP</i>: Primarily run CHAP, otherwise PAP.</li> <li>• <i>MS-CHAPv1</i>: Only run MS-CHAP version 1 (PPP Microsoft Challenge Handshake Authentication Protocol).</li> <li>• <i>PAP/CHAP/MS-CHAP</i>: Primarily run CHAP, on denial then the authentication protocol required by the connection partner. (MSCHAP version 1 or 2 possible.)</li> <li>• <i>MS-CHAPv2</i>: Run MS-CHAP version 2 only.</li> </ul>

Field	Description
	<ul style="list-style-type: none"> <li>• <i>None</i>: Some providers use no authentication. In this case, select this option.</li> </ul>
<b>DNS Negotiation</b>	<p>Select whether your device receives IP addresses for <b>DNS Server</b> primary domain name server <b>Primary</b> and <b>DNS Server</b> secondary domain name server <b>Secondary</b> from the connection partner or sends these to the connection partner.</p> <p>The function is enabled with <i>Enabled</i>.</p> <p>The function is enabled by default.</p>
<b>Prioritize TCP ACK Packets</b>	<p>Select whether the TCP download is to be optimised in the event of intensive TCP upload. This function can be specially applied for asymmetrical bandwidths (ADSL).</p> <p>The function is enabled with <i>Enabled</i>.</p> <p>The function is disabled by default.</p>
<b>LCP Alive Check</b>	<p>Select whether the availability of the remote terminal is to be checked by sending LCP echo requests or replies. This makes it possible to switch to a backup connection more quickly in the event of line faults.</p> <p>The function is enabled with <i>Enabled</i>.</p> <p>The function is enabled by default.</p>

## 18.1.6 IP Pools

The **IP Pools** menu displays a list of all IP pools.

Your device can operate as a dynamic IP address server for PPP connections. You can use this function by providing one or more pools of IP addresses. These IP addresses can be assigned to dialling-in connection partners for the duration of the connection.

Any host routes entered always have priority over IP addresses from the address pools. This means that, if an incoming call has been authenticated, your device first checks whether a host route is entered in the routing table for this caller. If not, your device can allocate an IP address from an address pool (if available). If address pools have more than one IP address, you cannot specify which connection partner receives which address. The addresses are initially assigned in order. If a new dial-in takes place within an interval of one hour, an attempt is made to allocate the same IP address that was assigned to this

partner the previous time.

### 18.1.6.1 Edit or New

Choose the **New** button to set up new IP address pools. Choose the  icon to edit existing entries.

#### Fields in the menu Basic Parameters

Field	Description
<b>IP Pool Name</b>	Enter any description to uniquely identify the IP pool.
<b>IP Address Range</b>	Enter the first (first field) and last (second field) IP address of the IP address pool.
<b>DNS Server</b>	<p><b>Primary:</b> Enter the IP address of the DNS server that is to be used, preferably, by clients who draw an address from this pool.</p> <p><b>Secondary:</b> Optionally, enter the IP address of an alternative DNS server.</p>

## 18.2 ATM

ATM (Asynchronous Transfer Mode) is a data transmission procedure that was originally designed for broadband ISDN.

ATM is currently used in high-speed networks. You will need ATM, for example, if you want high-speed access to the Internet via the integrated ADSL or SHDSL modem.

In an ATM network, different applications such as speech, video and data, can be transmitted side-by-side in the asynchronous time multiplex procedure. Each transmitter is provided with time sections for transmitting data. With asynchronous transmission, unused time sections of a transmitter are used by another transmitter.

With ATM, the packet switching procedure is connected-based. A virtual connection is used for data transmission that negotiates between the transmitter and recipient or is configured on both sides. This determines the route that the data should take, for example. Multiple virtual connections can be set up over a single physical interface.

The data is transmitted in so-called cells or slots of constant size. Each cell consists of 48 bytes of usage data and 5 bytes of control information. The control information contains, amongst other things, the ATM address which is similar to the Internet address. The ATM address is made up of the Virtual Path Identifier (VPI) and the Virtual Connection Identifier

(VCI); this identifies the virtual connection.

Various types of traffic flows are transported over ATM. To take account of the various demands of these traffic flows on the networks, e.g. in terms of cell loss and delay time, suitable values can be defined using the service categories. Uncompressed video data, for example, requires different parameters to time-uncritical data.

In ATM networks Quality of Service (QoS) is available, i.e. the size of various network parameters, such as bit rate, delay and jitter can be guaranteed.

OAM (Operation, Administration and Maintenance) is used to monitor the data transmission in ATM. OAM includes configuration management, error management and performance measurement.

## 18.2.1 Profiles

A list of all ATM profiles is displayed in the **WAN->ATM->Profiles** menu.

If the connection for your Internet access is set up using the internal modem, the ATM connection parameters must be set for this. An ATM profile combines a set of parameters for a specific provider.

By default an ATM profile with the description *AUTO-CREATED* is preconfigured. Its values (VPI 1 and VCI 32) are suitable for a Telekom ATM connection, for example.



### Note

The ATM encapsulations are described in RFCs 1483 and 2684. You will find the RFCs on the relevant pages of the IETF ([www.ietf.org/rfc.html](http://www.ietf.org/rfc.html)).

### 18.2.1.1 New

Choose the **New** button to set up new ATM profiles.

The menu **WAN->ATM->Profiles->New** consists of the following fields:

#### Fields in the ATM Profiles Parameter menu.

Field	Description
<b>Provider</b>	Select one of the preconfigured ATM profiles for your provider from the list or manually define the profile using <code>-- User-defined --</code> .

Field	Description
<b>Description</b>	<p>Only for <b>Provider</b> = -- <i>User-defined</i> --</p> <p>Enter the desired description for the connection.</p>
<b>ATM Interface</b>	<p>Only if several ATM interfaces are available, e.g. if several interfaces are separately configured in devices with SHDSL.</p> <p>Select the ATM interface that you wish to use for the connection.</p>
<b>Type</b>	<p>Only for <b>Provider</b> = -- <i>User-defined</i> --</p> <p>Select the protocol for the ATM connection.</p> <p>Possible values:</p> <ul style="list-style-type: none"> <li>• <i>Ethernet over ATM</i> (default value): Ethernet over ATM (EthoA) is used for the ATM connection (Permanent Virtual Circuit, PVC).</li> <li>• <i>Routed Protocols over ATM</i>: Routed Protocols over ATM (RPoA) is used for the ATM connection (Permanent Virtual Circuit, PVC).</li> <li>• <i>PPP over ATM</i>: PPP over ATM (PPPoA) is used for the ATM connection (Permanent Virtual Circuit, PVC).</li> </ul>
<b>Virtual Path Identifier (VPI)</b>	<p>Only for <b>Provider</b> = -- <i>User-defined</i> --</p> <p>Enter the VPI value of the ATM connection. The VPI is the identification number of the virtual path to be used. Note your provider's instructions.</p> <p>Possible values are 0 to 255.</p> <p>The default value is 8.</p>
<b>Virtual Channel Identifier (VCI)</b>	<p>Only for <b>Provider</b> = -- <i>User-defined</i> --</p> <p>Enter the VCI value of the ATM connection. The VCI is the identification number of the virtual channel. A virtual channel is the logical connection for the transport of ATM cells between two or more points. Note your provider's instructions.</p> <p>Possible values are 32 to 65535.</p> <p>The default value is 32.</p>



Field	Description
<b>Encapsulation</b>	<p>Only for <b>Provider</b> = <i>-- User-defined --</i></p> <p>Select the encapsulation to be used. Note your provider's instructions.</p> <p>Possible values (in accordance with RFC 2684):</p> <ul style="list-style-type: none"> <li>• <i>LLC Bridged no FCS</i> (Default value for Ethernet over ATM : Is only displayed for <b>Type</b> = <i>Ethernet over ATM</i>. Bridged Ethernet with LLC/SNAP encapsulation without Frame Check Sequence (checksums).</li> <li>• <i>LLC Bridged FCS</i>: only displayed for <b>Type</b> = <i>Ethernet over ATM</i>. Bridged Ethernet with LLC/SNAP encapsulation with Frame Check Sequence (checksums).</li> <li>• <i>Non ISO</i> (default value for Routed Protocols over ATM): Is only displayed for <b>Type</b> = <i>Routed Protocols over ATM</i>. Encapsulation with LLC/SNAP header, suitable for IP routing.</li> <li>• <i>LLC</i>: only displayed for <b>Type</b> = <i>PPP over ATM</i>. Encapsulation with LLC header.</li> <li>• <i>VC Multiplexing</i> (default value for PPP over ATM): Bridged Ethernet without additional encapsulation (Null Encapsulation) with Frame Check Sequence (checksums).</li> </ul>

**Fields in menu Ethernet over ATM Settings (appears only for Type = Ethernet over ATM)**

Field	Description
<b>Default Ethernet for PPPoE Interfaces</b>	<p>Only for <b>Type</b> = <i>Ethernet over ATM</i></p> <p>Select whether this Ethernet-over-ATM interface is to be used for all PPPoE connections</p> <p>The function is enabled with <i>Enabled</i>.</p> <p>The function is disabled by default.</p>
<b>Address Mode</b>	<p>Only for <b>Type</b> = <i>Ethernet over ATM</i></p> <p>Select how an IP address is to be assigned to the interface.</p>

Field	Description
	<p>Possible values:</p> <ul style="list-style-type: none"> <li>• <i>Static</i> (default value): The interface is assigned a static IP address in <b>IP Address / Netmask</b>.</li> <li>• <i>DHCP</i>: An IP address is assigned to the interface dynamically via DHCP.</li> </ul>
<b>IP Address/Netmask</b>	<p>Only for <b>Address Mode</b> = <i>Static</i></p> <p>Enter the IP addresses (<b>IP Address</b>) and the corresponding netmasks (<b>Netmask</b>) of the ATM interfaces. Add new entries with <b>Add</b>.</p>
<b>MAC Address</b>	<p>Enter a MAC address for the internal router interface of ATM connection, e.g. <i>00:a0:f9:06:bf:03</i>. An entry is only required in special cases.</p> <p>For Internet connections, it is sufficient to select the option <b>Use built-in</b> (default setting). An address is used which is derived from the MAC address of the <i>en1-0</i>.</p>
<b>DHCP MAC Address</b>	<p>Only for <b>Address Mode</b> = <i>DHCP</i></p> <p>Enter the MAC address of the internal router interface of ATM connection, e.g. <i>00:e1:f9:06:bf:03</i>.</p> <p>If your provider has assigned you a MAC address for DHCP, enter this here.</p> <p>You can also select the <b>Use built-in</b> option (default setting) An address is used which is derived from the MAC address of the <i>en1-0</i>.</p>
<b>DHCP Hostname</b>	<p>Only for <b>Address Mode</b> = <i>DHCP</i></p> <p>If necessary, enter the host name registered with the provider to be used by your device for DHCP requests.</p> <p>The maximum length of the entry is 45 characters.</p>

**Fields in menu Routed Protocols over ATM Settings (appears only for Type = Routed Protocols over ATM)**

Field	Description
<b>IP Address/Netmask</b>	Enter the IP addresses ( <b>IP Address</b> ) and the corresponding netmasks ( <b>Netmask</b> ) of the ATM interface. Add new entries with <b>Add</b> .
<b>Prioritize TCP ACK Packets</b>	Select whether the TCP download is to be optimised in the event of intensive TCP upload. This function can be specially applied for asymmetrical bandwidths (ADSL).  The function is enabled with <i>Enabled</i> .  The function is disabled by default.

#### Field in menu **PPP over ATM Settings** (appears only for **Type = PPP over ATM**)

Field	Description
<b>Client Type</b>	Select whether the PPPoA connection is to be set up permanently or on demand.  Possible values:  <ul style="list-style-type: none"> <li>• <i>On Demand</i> (default value): The PPPoA is only set up on demand, e.g. for Internet access.</li> </ul> <p>You'll find additional information on PPP over ATM under <a href="#">PPPoA</a> on page 395.</p>

## 18.2.2 Service Categories

In the **WAN->ATM->Service Categories** menu is displayed a list of already configured ATM connections (PVC, Permanent Virtual Circuit) to which specific data traffic parameters were assigned.

Your device supports QoS (Quality of Service) for ATM interfaces.



### Caution

ATM QoS should only be used if your provider specifies a list of data traffic parameters (traffic contract).

The configuration of ATM QoS requires extensive knowledge of ATM technology and the way the bintec elmeg devices function. An incorrect configuration can cause considerable disruption during operation. If applicable, save the original configuration on your PC.

### 18.2.2.1 New

Choose the **New** button to create additional categories.

The menu **WAN->ATM->Service Categories->New** consists of the following fields:

#### Fields in the **Basic Parameters** menu.

Field	Description
<b>Virtual Channel Connection (VCC)</b>	Select the already configured ATM connection (displayed by the combination of VPI and VCI) for which the service category is to be defined.
<b>ATM Service Category</b>	<p>Select how the data traffic of the ATM connection is to be controlled.</p> <p>A priority is implicitly assigned when you select the ATM service category: from CBR (highest priority) through VBR.1 /VBR.3 to VBR (lowest priority).</p> <p>Possible settings:</p> <ul style="list-style-type: none"> <li>• <i>Unspecified Bit Rate (UBR)</i> (default value): No specific data rate is guaranteed for the connection. The <b>Peak Cell Rate (PCR)</b> specifies the limit above which data is discarded. This category is suitable for non-critical applications.</li> <li>• <i>Constant Bit Rate (CBR)</i>: (Constant Bit Rate) The connection is assigned a guaranteed data rate determined by the <b>Peak Cell Rate (PCR)</b>. This category is suitable for critical (real-time) applications that require a guaranteed data rate.</li> <li>• <i>Variable Bit Rate V.1 (VBR.1)</i>: A guaranteed data rate is assigned to the connection - <b>Sustained Cell Rate (SCR)</b>. This may be exceeded by the volume configured in <b>Maximum Burst Size (MBS)</b>. Any additional ATM traffic is discarded. The <b>Peak Cell Rate (PCR)</b> constitutes the maximum possible data rate. This category is suitable for non-critical applications with burst data traffic.</li> <li>• <i>Variable Bit Rate V.3 (VBR.3)</i>: A guaranteed data rate is assigned to the connection - <b>Sustained Cell Rate (SCR)</b>. This may be exceeded by the volume configured in <b>Maximum Burst Size (MBS)</b>. Additional ATM traffic is marked and handled with low priority based on the utilisation of the destination network, i.e. is discarded if necessary. The <b>Peak Cell Rate (PCR)</b> constitutes the maximum possible data</li> </ul>

Field	Description
	rate. This category is suitable for critical applications with burst data traffic.
<b>Peak Cell Rate (PCR)</b>	<p>Enter a value for the maximum data rate in bits per second.</p> <p>Possible values: 0 to 10000000.</p> <p>The default value is 0.</p>
<b>Sustained Cell Rate (SCR)</b>	<p>Only for <b>ATM Service Category</b> = <i>Variable Bit Rate V.1 (VBR.1)</i> or <i>Variable Bit Rate V.3 (VBR.3)</i></p> <p>Enter a value for the minimum available, guaranteed data rate in bits per second.</p> <p>Possible values: 0 to 10000000.</p> <p>The default value is 0.</p>
<b>Maximum Burst Size (MBS)</b>	<p>Only for <b>ATM Service Category</b> = <i>Variable Bit Rate V.1 (VBR.1)</i> or <i>Variable Bit Rate V.3 (VBR.3)</i></p> <p>Enter a value for the maximum number of bits per second by which the PCR can be exceeded briefly.</p> <p>Possible values: 0 to 100000.</p> <p>The default value is 0.</p>

### 18.2.3 OAM Controlling

OAM is a service for monitoring ATM connections. A total of five hierarchies (flow level F1 to F5) are defined for OAM information flow. The most important information flows for an ATM connection are F4 and F5. The F4 information flow concerns the virtual path (VP) and the F5 information flow the virtual channel (VC). The VP is defined by the VPI value, the VC by VPI and VCI.



#### Note

Generally, monitoring is not carried out by the terminal but is initiated by the ISP. Your device then only needs to react correctly to the signals received. This is ensured without a specific OAM configuration for both flow level 4 and flow level 5.

Two mechanisms are available for monitoring the ATM connection: Loopback Tests and OAM Continuity Check (OAM CC). These can be configured independently of each other.



### Caution

The configuration of OAM requires extensive knowledge of ATM technology and the way the bintec elmeg devices functions. An incorrect configuration can cause considerable disruption during operation. If applicable, save the original configuration on your PC.

In the **WAN->ATM->OAM Controlling** menu, a list of all monitored OAM flow levels is displayed.

#### 18.2.3.1 New

Choose the **New** button to set up monitoring for other flow levels.

The menu **WAN->ATM->OAM Controlling->New** consists of the following fields:

#### Fields in the OAM Flow Configuration menu.

Field	Description
<b>OAM Flow Level</b>	Select the OAM flow level to be monitored.  Possible values: <ul style="list-style-type: none"> <li>• <i>F5</i>: (virtual channel level) The OAM settings are used for the virtual channel (default value).</li> <li>• <i>F4</i> : (virtual path level) The OAM settings are used on the virtual path.</li> </ul>
<b>Virtual Channel Connection (VCC)</b>	Only for <b>OAM Flow Level</b> = <i>F5</i>  Select the already configured ATM connection to be monitored (displayed by the combination of VPI and VCI).
<b>Virtual Path Connection (VPC)</b>	Only for <b>OAM Flow Level</b> = <i>F4</i>  Select the already configured virtual path connection to be monitored (displayed by the VPI).

#### Fields in the Loopback menu.

Field	Description
<b>Loopback End-to-End</b>	<p>Select whether you activate the loopback test for the connection between the endpoints of the VCC or VPC.</p> <p>The function is enabled with <i>Enabled</i>.</p> <p>The function is disabled by default.</p>
<b>End-to-End Send Interval</b>	<p>Only if <b>Loopback End-to-End</b> is enabled.</p> <p>Enter the time in seconds after which a loopback cell is to be sent.</p> <p>Possible values are <i>0</i> to <i>999</i>.</p> <p>The default value is <i>5</i>.</p>
<b>End-to-End Pending Requests</b>	<p>Only if <b>Loopback End-to-End</b> is enabled.</p> <p>Enter the number of directly consecutive loopback cells that may fail to materialise before the connection is regarded as interrupted ("down"). Possible values are <i>1</i> to <i>99</i>.</p> <p>The default value is <i>5</i>.</p>
<b>Loopback Segment</b>	<p>Select whether you want to activate the loopback test for the segment connection (segment = connection of the local endpoint to the next connection point) of the VCC or VPC.</p> <p>The function is enabled with <i>Enabled</i>.</p> <p>The function is disabled by default.</p>
<b>Segment Send Interval</b>	<p>Only if <b>Loopback Segment</b> is enabled.</p> <p>Enter the time in seconds after which a loopback cell is sent.</p> <p>Possible values are <i>0</i> to <i>999</i>.</p> <p>The default value is <i>5</i>.</p>
<b>Segment Pending Requests</b>	<p>Only if <b>Loopback Segment</b> is enabled.</p> <p>Enter the number of directly consecutive loopback cells that may fail to materialise before the connection is regarded as interrupted ("down").</p>

Field	Description
	<p>Possible values are 1 to 99.</p> <p>The default value is 5.</p>

#### Fields in the CC Activation menu.

Field	Description
<b>Continuity Check (CC) End-to-End</b>	<p>Select whether you activate the OAM-CC test for the connection between the endpoints of the VCC or VPC.</p> <p>Possible values:</p> <ul style="list-style-type: none"> <li>• <i>Passive</i> (default value): OAM CC requests are responded to after CC negotiation (CC activation negotiation).</li> <li>• <i>Active</i>: OAM CC requests are sent after CC negotiation (CC activation negotiation).</li> <li>• <i>Both</i>: OAM CC requests are sent and answered after CC negotiation (CC activation negotiation).</li> <li>• <i>No negotiation</i>: Depending on the setting in the <b>Direction</b> field, OAM CC requests are either sent and/or responded to. There is no CC negotiation.</li> <li>• <i>Passive</i>: The function is disabled.</li> </ul> <p>Also select whether the test cells of the OAM CC are to be sent or received.</p> <p>Possible values:</p> <ul style="list-style-type: none"> <li>• <i>Both</i> (default value): CC data is both received and generated.</li> <li>• <i>Sink</i>: CC data is received.</li> <li>• <i>Source</i>: CC data is generated.</li> </ul>
<b>Continuity Check (CC) Segment</b>	<p>Select whether you want to activate the OAM-CC test for the segment connection (segment = connection of the local endpoint to the next connection point) of the VCC or VPC.</p> <p>Possible values:</p> <ul style="list-style-type: none"> <li>• <i>Passive</i> (default value): OAM CC requests are responded to after CC negotiation (CC activation negotiation).</li> <li>• <i>Active</i>: OAM CC requests are sent after CC negotiation (CC</li> </ul>



Field	Description
	<p>activation negotiation).</p> <ul style="list-style-type: none"> <li>• <i>Both</i>: OAM CC requests are sent and answered after CC negotiation (CC activation negotiation).</li> <li>• <i>No negotiation</i>: Depending on the setting in the <b>Direction</b> field, OAM CC requests are either sent and/or responded to. There is no CC negotiation.</li> <li>• <i>None</i>: The function is disabled.</li> </ul> <p>Also select whether the test cells of the OAM CC are to be sent or received.</p> <p>Possible settings:</p> <ul style="list-style-type: none"> <li>• <i>Both</i> (default value): CC data is both received and generated.</li> <li>• <i>Sink</i>: CC data is received.</li> <li>• <i>Source</i>: CC data is generated.</li> </ul>

## 18.3 Real Time Jitter Control

When telephoning over the Internet, voice data packets normally have the highest priority. Nevertheless, if the upstream bandwidth is low, noticeable delays in voice transmission can occur when other packets are routed at the same time.

The real time jitter control function solves this problem. So that the "line" is not blocked for too long for the voice data packets, the size of the other packets can be reduced, if required, during a telephone call.

### 18.3.1 Controlled Interfaces

In the **WAN->Real Time Jitter Control->Controlled Interfaces** a list of functions is displayed for which the Real Time Jitter Control function is configured.

#### 18.3.1.1 New

Click the **New** button to optimise voice transmission for other interfaces.

The menu **WAN->Real Time Jitter Control->Controlled Interfaces->New** consists of the following fields:

**Fields in the Basic Settings menu.**

Field	Description
<b>Interface</b>	Define for which interfaces voice transmission is to be optimised.
<b>Control Mode</b>	Select the mode for the optimisation.  Possible values: <ul style="list-style-type: none"><li>• <i>Controlled RTP Streams only</i> (default value): By means of the data routed via the media gateway, the system detects voice data traffic and optimises the voice transmission.</li><li>• <i>All RTP Streams</i>: All RTP streams are optimised.</li><li>• <i>Inactive</i>: Voice data transmission is not optimised.</li><li>• <i>Always</i>: Voice data transmission is always optimised.</li></ul>
<b>Maximum Upload Speed</b>	Enter the maximum available upstream bandwidth in kbp/s for the selected interface.

## Chapter 19 VPN

A connection that uses the Internet as a "transport medium" but is not publicly accessible is referred to as a VPN (Virtual Private Network). Only authorised users have access to such a VPN, which is seemingly also referred to as a VPN tunnel. Normally the data transported over a VPN is encrypted.

A VPN allows field staff or staff working from home offices to access data on the company's network. Subsidiaries can also connect to head office over VPN.

The connection partner is authenticated with a password, using preshared keys or certificates.

With IPSec the data is encrypted using AES or 3DES, for example.

### 19.1 IPSec

IPSec enables secure connections to be set up between two locations (VPN). This enables sensitive business data to be transferred via an unsecure medium such as the Internet. The devices used function here as the endpoints of the VPN tunnel. IPSec involves a number of Internet Engineering Task Force (IETF) standards, which specify mechanisms for the protection and authentication of IP packets. IPSec offers mechanisms for encrypting and decrypting the data transferred in the IP packets. The IPSec implementation can also be smoothly integrated in a Public Key Infrastructure (PKI, see [Certificates](#) on page 77). IPSec implementation achieves this firstly by using the Authentication Header (AH) protocol and Encapsulated Security Payload (ESP) protocol and secondly through the use of cryptographic key administration mechanisms like the Internet Key Exchange (IKE) protocol.

#### Additional IPv4 Traffic Filter

**bintec elmeg** gateways support two different methods of setting up IPSec connections:

- a method based on policies and
- a method based on routing.

The policy-based method uses data traffic filters to negotiate the IPSec phase 2 SAs. This allows for a very "fine-grained" filter to be applied to the IP packet, even at the level of the protocol and the port.

The routing-based method offers various advantages over the policy-based method, e.g., NAT/PAT within a tunnel, IPSec in combination with routing protocols and the creation of VPN backup scenarios. With the routing-based method, the configured or dynamically

learned routes are used to negotiate the IPsec phase 2 SAs. Although this method does simplify many configurations, problems may also be caused by competing routes or the "coarser" filtering of data traffic.

The **Additional IPv4 Traffic Filter** parameter fixes this problem. You can apply a "finer" filter, i.e. you can enter the source IP address or the source port. If a **Additional IPv4 Traffic Filter** is configured, this is used to negotiate the IPsec phase 2 SAs; the route now only determines which data traffic is to be routed.

If an IP packet does not match the defined **Additional IPv4 Traffic Filter**, it is rejected.

If an IP packet meets the requirements in an **Additional IPv4 Traffic Filter**, IPsec phase 2 negotiation begins and data traffic is transferred over the tunnel.



#### Note

The parameter **Additional IPv4 Traffic Filter** is exclusively relevant for the initiator of the IPsec connection, it is only used for outgoing traffic.



#### Note

Please note that the phase 2 policies must be configured identically on both of the IPsec tunnel endpoints.

## 19.1.1 IPsec Peers

An endpoint of a communication is defined as peer in a computer network. Each peer offers its services and uses the services of other peers.

A list of all configured IPsec Peers is sorted by priority displayed in the **VPN->IPsec->IPsec Peers** menu.

### Peer Monitoring

The menu for monitoring a peer is called by selecting the  button for the peer in the peer list. See *Values in the IPsec Tunnels list* on page 579.

#### 19.1.1.1 New

Choose the **New** button to set up more IPsec peers.

The menu **VPN->IPSec->IPSec Peers->New** consists of the following fields:

#### Fields in the menu Peer Parameters

Field	Description
<b>Administrative Status</b>	<p>Select the status to which you wish to set the peer after saving the peer configuration.</p> <p>Possible values:</p> <ul style="list-style-type: none"> <li>• <i>Up</i> (default value): The peer is available for setting up a tunnel immediately after saving the configuration.</li> <li>• <i>Down</i>: The peer is initially not available after the configuration has been saved.</li> </ul>
<b>Description</b>	<p>Enter a description of the peer that identifies it.</p> <p>The maximum length of the entry is 255 characters.</p>
<b>Peer Address</b>	<p>Select the <b>IP Version</b>. You can choose if IPv4 or IPv6 is to be preferred or if only one IP version is to be permitted.</p> <div data-bbox="539 918 1315 1072" style="border: 1px solid gray; background-color: #f0f0f0; padding: 5px; margin: 10px 0;"> <p> <b>Note</b></p> <p>This selection is only relevant if an IP address is entered as host name.</p> </div> <p>Possible values:</p> <ul style="list-style-type: none"> <li>• <i>IPv4 Preferred</i></li> <li>• <i>IPv6 Preferred</i></li> <li>• <i>IPv4 Only</i></li> <li>• <i>IPv6 Only</i></li> </ul> <p>Enter the public IP address of the peer or a resolvable host name.</p> <p>This entry can be omitted in certain configurations, but in that case your device cannot initiate an IPSec connection.</p>
<b>Peer ID</b>	<p>Select the ID type and enter the peer ID.</p> <p>This entry is not necessary in certain configurations.</p>

Field	Description
	<p>The maximum length of the entry is 255 characters.</p> <p>Possible ID types:</p> <ul style="list-style-type: none"> <li>• <i>Fully Qualified Domain Name (FQDN)</i>: Any string</li> <li>• <i>E-mail Address</i></li> <li>• <i>IPV4 Address</i></li> <li>• <i>ASN.1-DN (Distinguished Name)</i></li> <li>• <i>Key ID</i>: Any string</li> </ul> <p>On the peer device, this ID corresponds to the <b>Local ID Value</b>.</p>
<b>Internet Key Exchange</b>	<p>Select the version of the Internet Exchange Protocol to be used.</p> <p>Possible values:</p> <ul style="list-style-type: none"> <li>• <i>IKEv1</i> (default value): Internet Key Exchange Protocol Version 1</li> <li>• <i>IKEv2</i>: Internet Kex Exchange Protocol Version 2</li> </ul>
<b>Authentication Method</b>	<p>Only for <b>Internet Key Exchange = IKEv2</b></p> <p>Select the authentication method.</p> <p>Possible values:</p> <ul style="list-style-type: none"> <li>• <i>Preshared Keys</i> (default value): If you do not use certificates for the authentication, you can select Preshared Keys. These are configured during peer configuration in the <b>IPSec Peers</b>. The preshared key is the shared password.</li> <li>• <i>RSA Signature</i>: Phase 1 key calculations are authenticated using the RSA algorithm.</li> </ul>
<b>Local ID Type</b>	<p>Only for <b>Internet Key Exchange = IKEv2</b></p> <p>Select the local ID type.</p> <p>Possible ID types:</p> <ul style="list-style-type: none"> <li>• <i>Fully Qualified Domain Name (FQDN)</i></li> <li>• <i>E-mail Address</i></li> <li>• <i>IPV4 Address</i></li> <li>• <i>ASN.1-DN (Distinguished Name)</i></li> </ul>

Field	Description
	<ul style="list-style-type: none"> <li>• <i>Key ID</i>: Any string</li> </ul>
<b>Local ID</b>	<p>Only for <b>Internet Key Exchange</b> = <i>IKEv2</i></p> <p>Enter the ID of your device.</p> <p>For <b>Authentication Method</b> = <i>DSA Signature</i> or <i>RSA Signature</i> the option <b>Use Subject Name from certificate</b> is displayed.</p> <p>When you enable the option <b>Use Subject Name from certificate</b>, the first alternative subject name indicated in the certificate is used, or, if none is specified, the subject name of the certificate is used.</p> <p>Note: If you use certificates for authentication and your certificate contains alternative subject names (see <a href="#">Certificates</a> on page 77), you must make sure your device selects the first alternative subject name by default. Make sure you and your peer both use the same name, i.e. that your local ID and the peer ID your partner configures for you are identical.</p>
<b>Preshared Key</b>	<p>Enter the password agreed with the peer.</p> <p>The maximum length of the entry is 50 characters. All characters are possible except for <i>0x</i> at the start of the entry.</p>
<b>IP Version of the tunneled Networks</b>	<p>Select if IPv4, IPv6 or both versions are allowed for the VPN tunnel.</p> <p>Possible values:</p> <ul style="list-style-type: none"> <li>• <i>IPv4</i></li> <li>• <i>IPv6</i></li> <li>• <i>IPv4 and IPv6</i></li> </ul>

**Fields in the menu IPv4 Interface Routes (appears only for IP Version of the tunneled Networks = IPv4 or IPv4 and IPv6)**

Field	Description
<b>Security Policy</b>	<p>Select the security settings to be used with the interface.</p> <p>Possible values:</p>

Field	Description
	<ul style="list-style-type: none"> <li>• <i>Trusted</i>: All IP packets are allowed through except for those which are explicitly prohibited.</li> <li>• <i>Untrusted</i> (default value): Only those packets are transmitted that can be attributed to a connection that has been initiated from a trusted zone.</li> </ul> <p>You can configure exceptions for the selected setting in the <a href="#">Firewall</a> on page 460 menu.</p>
<b>IP Address Assignment</b>	<p>Select the configuration mode of the interface.</p> <p>Possible values:</p> <ul style="list-style-type: none"> <li>• <i>Static</i> (default value): Enter a static IP address.</li> <li>• <i>IKE Config Mode Client</i>: Can only be selected for IKEv1. Select this option if your gateway receives an IP address from the server as IPSec client.</li> <li>• <i>IKE Config Mode Server</i>: Select this option if your gateway assigns an IP address as server for connecting clients. This is taken from the selected <b>IP Assignment Pool</b>.</li> </ul>
<b>Config Mode</b>	<p>Only where <b>IP Address Assignment</b> = <i>IKE Config Mode Server</i> or <i>IKE Config Mode Client</i></p> <p>Possible values:</p> <ul style="list-style-type: none"> <li>• <i>Pull</i> (default value): The client requests the IP address and the gateway answers the request.</li> <li>• <i>Push</i>: The gateway suggests an IP address to the client and the client must either accept or reject this.</li> </ul> <p>This value must be identical for both sides of the tunnel.</p>
<b>IP Assignment Pool</b>	<p>Only if <b>IP Address Assignment</b> = <i>IKE Config Mode Server</i></p> <p>Select an IP pool configured in the <b>VPN-&gt;IPSec-&gt;IP Pools</b> menu. If an IP pool has not been configured here yet, the message <i>Not yet defined</i> appears in this field.</p>
<b>Default Route</b>	<p>Only for <b>IP Address Assignment</b> = <i>Static</i> or <i>IKE Config Mode Client</i></p> <p>Select whether the route to this IPSec peer is to be defined as</p>



Field	Description
	<p>the default route.</p> <p>The function is enabled with <i>Enabled</i>.</p> <p>The function is disabled by default.</p>
<b>Local IP Address</b>	<p>Only for <b>IP Address Assignment</b> = <i>Static</i> or <i>IKE Config Mode Server</i></p> <p>Enter the WAN IP address of your IPsec tunnel. This can be the same IP address as the address configured on your router as the LAN IP address.</p>
<b>Metric</b>	<p>Only for <b>IP Address Assignment</b> = <i>Static</i> or <i>IKE Config Mode Client</i> and <b>Default Route</b> = <i>Enabled</i></p> <p>Select the priority of the route.</p> <p>The lower the value, the higher the priority of the route.</p> <p>Value range from <i>0</i> to <i>15</i>. The default value is <i>1</i>.</p>
<b>Route Entries</b>	<p>Only for <b>IP Address Assignment</b> = <i>Static</i> or <i>IKE Config Mode Client</i></p> <p>Define routing entries for this connection partner.</p> <ul style="list-style-type: none"> <li>• <i>Remote IP Address</i>: IP address of the destination host or LAN.</li> <li>• <i>Netmask</i>: Netmask for <i>Remote IP Address</i>.</li> <li>• <i>Metric</i>: The lower the value, the higher the priority of the route (possible values <i>0..15</i>). The default value is <i>1</i>.</li> </ul>

**Fields in the menu Additional IPv4 Traffic Filter (appears only for IP Version of the tunneled Networks = IPv4 or IPv4 and IPv6)**

Field	Description
<b>Additional IPv4 Traffic Filter</b>	<p>Only for <b>Internet Key Exchange</b> = <i>IKEv1</i></p> <p>Use <b>Add</b> to create a new filter.</p>

**Fields in the IPv6 Interface Routes menu (appears only for IP Version of the tunneled Networks = IPv6 or IPv4 and IPv6)**

Field	Description
<b>Security Policy</b>	<p>Select the security settings to be used with the interface..</p> <p>Possible values:</p> <ul style="list-style-type: none"> <li>• <i>Untrusted</i>: IP packets are only allowed through if the connection has been initiated from "inside".</li> </ul> <p>We recommend you use this setting if you want to use IPv6 outside of your LAN.</p> <ul style="list-style-type: none"> <li>• <i>Trusted</i> (default value): All IP packets are allowed through except for those which are explicitly prohibited.</li> </ul> <p>We recommend you use this setting if you want to use IPv6 on your LAN.</p> <p>You can configure exceptions for the selected setting in the <a href="#">Firewall</a> on page 460 menu.</p>
<b>Local IPv6 Network</b>	<p>Select a network. You can choose from the Link Prefixes available under <b>LAN-&gt;IP Configuration-&gt;Interfaces-&gt;New</b>.</p> <p>Enter the Local IPv6 address and the corresponding prefix length. The default prefix length is /64. This prefix must end with ::.</p>
<b>Remote IPv6 Network</b>	<p>Add a new prefix. Enter the address of the other tunnel endpoint. The default prefix <b>Length</b> is <i>64</i> and the default <b>Priority</b> is <i>1</i>. The lower the value entered for <b>Priority</b>, the higher the priority of the route.</p>

### Additional data traffic filters

**bintec elmeg** Gateways support two different methods for establishing IPSec connections:

- a method based on policies and
- a method based on routing.

The policy-based method uses data traffic filters to negotiate the IPSec phase 2 SAs. This enables the filtering of the IP packets to be very "fine grained" down to protocol and port level.

The routing-based method offers various advantages over the policy-based method, e.g., NAT/PAT within a tunnel, IPSec in combination with routing protocols and the creation of VPN backup scenarios. With the routing-based method, the configured or dynamically learned routes are used to negotiate the IPSec phase 2 SAs. While it is true that this meth-

od simplifies many configurations, at the same time there can be problems due to competing routes or the "coarser" filtering of the data traffic.

The **Additional IPv4 Traffic Filter** parameter fixes this problem. You can filter more "finely", i. e. you can, e. g., specify the source IP address or the source port. If there is a **Additional IPv4 Traffic Filter** configured, it is used to negotiate the IPSec phase 2 SAs; the route only determines which data traffic is to be routed.

If an IP packet does not match the defined **Additional IPv4 Traffic Filter** it is discarded.

If an IP packet meets the requirements in an **Additional IPv4 Traffic Filter**, IPSec phase 2 negotiation begins and data traffic is transferred over the tunnel.



#### Note

The parameter **Additional IPv4 Traffic Filter** is only relevant to the initiator of the IPSec connection, it only applies to outgoing data traffic.



#### Note

Please note that the phase 2 policies must be configured identically on both of the IPSec tunnel endpoints.

Add new entries with **Add**.

#### Fields in the menu **Basic Parameters**

Field	Description
<b>Description</b>	Enter a description for the filter.
<b>Protocol</b>	Select a protocol. The <i>Any</i> option (default value) matches all protocols.
<b>Source IP Address/ Netmask</b>	Enter, if required, the source IP address and netmask of the data packets.  Possible values: <ul style="list-style-type: none"> <li>• <i>Any</i></li> <li>• <i>Host</i>: Enter the IP address of the host.</li> <li>• <i>Network</i> (default value): Enter the network address and the</li> </ul>

Field	Description
	related netmask.
<b>Source Port</b>	Only for <b>Protocol</b> = <i>TCP</i> or <i>UDP</i>  Enter the source port of the data packets. The default setting <i>-All-</i> (= -1) means that the port remains unspecified.
<b>Destination IP Address/Netmask</b>	Enter the destination IP address and corresponding netmask of the data packets.
<b>Destination Port</b>	Only for <b>Protocol</b> = <i>TCP</i> or <i>UDP</i>  Enter the destination port of the data packets. The default setting <i>-All-</i> (= -1) means that the port remains unspecified.

The menu **Advanced Settings** consists of the following fields:

#### Fields in the menu **Advanced IPsec Options**

Field	Description
<b>Phase-1 Profile</b>	Select a profile for Phase 1. Besides user-defined profiles, pre-defined profiles are available.  Possible values: <ul style="list-style-type: none"> <li>• <i>None (use default profile)</i>: Uses the profile marked as standard in <b>VPN-&gt;IPsec-&gt;Phase-1 Profiles</b></li> <li>• <i>Multi-Proposal</i>: Uses a special profile which contains the proposals for Phase 1 3DES/MD5, AES/MD5 and Blowfish/MD5 regardless of the proposal selection in menu <b>VPN-&gt;IPsec-&gt;Phase-1 Profiles</b>.</li> <li>• <i>&lt;Profilname&gt;</i>: Uses a profile configured in menu <b>VPN-&gt;IPsec-&gt;Phase-1 Profiles</b> for Phase 1.</li> </ul>
<b>Phase-2 Profile</b>	Select a profile for Phase 2. Besides user-defined profiles, pre-defined profiles are available.  Possible values: <ul style="list-style-type: none"> <li>• <i>None (use default profile)</i>: Uses the profile marked as standard in <b>VPN-&gt;IPsec-&gt;Phase-2 Profiles</b></li> <li>• <i>Multi-Proposal</i>: Uses a special profile which contains the proposals for Phase 2 3DES/MD5, AES-128/MD5 and Blow-</li> </ul>

Field	Description
	<p>fish/MD5 regardless of the proposal selection in menu <b>VPN-&gt;IPSec-&gt;Phase-2 Profiles</b>.</p> <ul style="list-style-type: none"> <li>• <i>&lt;Profilname&gt;</i>: Uses a profile configured in menu <b>VPN-&gt;IPSec-&gt;Phase-2 Profiles</b> for Phase 2.</li> </ul>
<b>XAUTH Profile</b>	<p>Select a profile created in <b>VPN-&gt;IPSec-&gt;XAUTH Profiles</b> if you wish to use this IPSec peer XAuth for authentication.</p> <p>If XAuth is used together with IKE Config Mode, the transactions for XAuth are carried out before the transactions for IKE Config Mode.</p>
<b>Number of Admitted Connections</b>	<p>Choose how many users can connect using this peer profile.</p> <p>Possible values:</p> <ul style="list-style-type: none"> <li>• <i>One User</i> (default value): Only one peer can be connected with the data defined in this profile.</li> <li>• <i>Multiple Users</i>: Several peers can be connected with the data defined in this profile. The peer entry is duplicated for each connection request with the data defined in this profile.</li> </ul> <p>The dynamic peer configuration on the gateway must not specify a peer ID or a peer IP address. Clients connecting to the gateway, however, must have a peer ID specified in the client peer configuration, since the ID is still used to differentiate the tunnels created via the dynamic peer.</p> <p>The resulting gateway peer would match all incoming tunnel requests. It is, therefore, essential to put it at the end of the IPSec peer list on the gateway. Otherwise all peers that follow the dynamic peer in the peer list would be inactive.</p>
<b>Start Mode</b>	<p>Select how the peer is to be switched to the active state.</p> <p>Possible values:</p> <ul style="list-style-type: none"> <li>• <i>On Demand</i> (default value): The peer is switched to the active state by a trigger.</li> <li>• <i>Always up</i>: The peer is always active.</li> </ul>

#### Fields in the menu **Advanced IP Options**

Field	Description
<b>Public Interface</b>	Specify the public (or WAN) interface that this peer is to use to connect to its VPN partner. If you select <i>Chosen by Routing</i> , the decision as to via which interface the data traffic is routed is made based on the current routing table. If you select an interface, the interface is used taking into consideration the setting under <b>Public Interface Mode</b> .
<b>Public Interface Mode</b>	<p>Only when an interface is selected for <b>Public Interface</b>.</p> <p>Specify how strictly the setting is handled.</p> <p>Possible values:</p> <ul style="list-style-type: none"> <li>• <i>Force</i>: Only the selected interface is used, independently from the priorities in the current routing table.</li> <li>• <i>Preferred</i>: The priorities in the current routing table will be used. Only if several equivalent routes are available, the route via the selected interface will be applied.</li> </ul>
<b>Public Source IPv4 Address</b>	<p>If you are operating more than one Internet connection in parallel, here you can specify the public IP address that is to be used as the source address for the peer's data traffic. Select whether the <b>Public Source IPv4 Address</b> is to be enabled.</p> <p>The function is enabled with <i>Enabled</i>.</p> <p>In the input field, enter the public IP address that is to be used as the sender address.</p> <p>The function is disabled by default.</p>
<b>Public Source IPv6 Address</b>	<p>If you are operating more than one Internet connection in parallel, here you can specify the public IP address that is to be used as the source address for the peer's data traffic. Select whether the <b>Public Source IPv6 Address</b> is to be enabled.</p> <p>The function is enabled with <i>Enabled</i>.</p> <p>In the input field, enter the public IP address that is to be used as the sender address.</p> <p>The function is disabled by default.</p>
<b>IPv4 Back Route Verify</b>	Select whether a check on the back route should be activated for the interface to the connection partner.

Field	Description
	<p>The function is enabled with <i>Enabled</i>.</p> <p>The function is disabled by default.</p>
<b>MobiKE</b>	<p>Only for peers with IKEv2.</p> <p><b>MobiKE</b> In cases of changing public IP addresses, enables only these addresses to be updated in the SAs without the SAs themselves having to be renegotiated.</p> <p>The function is enabled by default.</p> <p>Note that MobiKE requires a current IPSec client, e. g. the current Windows 7 or Windows 8 client or the latest version of the bintec elmeg IPSec client.</p>
<b>IPv4 Proxy ARP</b>	<p>Select whether your device is to respond to ARP requests from its own LAN on behalf of the specific connection partner.</p> <p>Possible values:</p> <ul style="list-style-type: none"> <li>• <i>Inactive</i> (default value): Deactivates Proxy ARP for this IPSec peer.</li> <li>• <i>Up or Dormant</i>: Your device only responds to an ARP request if the status of the connection to the IPSec peer is <i>Up</i> (active) or <i>Dormant</i> (dormant). In the case of <i>Dormant</i>, your device only responds to the ARP request; the connection is not set up until someone actually wants to use the route.</li> <li>• <i>Up only</i>: Your device responds to an ARP request only if the status of the connection to the IPSec peer is <i>Up</i> (active), i.e. a connection already exists to the IPSec peer.</li> </ul>

### IPSec Callback

bintec elmeg devices support the DynDNS service to enable hosts without fixed IP addresses to obtain a secure connection over the Internet. This service enables a peer to be identified using a host name that can be resolved by DNS. You do not need to configure the IP address of the peer.

The DynDNS service does not signal whether a peer is actually online and cannot cause a peer to set up an Internet connection to enable an IPSec tunnel over the Internet. This possibility is created with IPSec callback: Using a direct ISDN call to a peer, you can signal that you are online and waiting for the peer to set up an IPSec tunnel over the Internet. If

the called peer currently has no connection to the Internet, the ISDN call causes a connection to be set up. This ISDN call costs nothing (depending on country), as it does not have to be accepted by your device. The identification of the caller from his or her ISDN number is enough information to initiate setting up a tunnel.

To set up this service, you must first configure a call number for IPsec callback on the passive side in the **Physical Interfaces->ISDN Ports->MSN Configuration->New** menu. The value *IPSec* is available for this purpose in the field **Service**. This entry ensures that incoming calls for this number are routed to the IPsec service.

If callback is active, the peer is caused to initiate setting up an IPsec tunnel by an ISDN call as soon as this tunnel is required. If callback is set to passive, setting up a tunnel to the peer is always initiated if an ISDN call is received on the relevant number (**MSN** in menu **Physical Interfaces->ISDN Ports->MSN Configuration->New** for **Service** *IPSec*). This ensures that both peers are reachable and that the connection can be set up over the Internet. The only case in which callback is not executed is if SAs (Security Associations) already exist, i.e. the tunnel to the peer already exists.



#### Note

If a tunnel is to be set up to a peer, the interface over which the tunnel is to be implemented is activated first by the IPsec Daemon. If IPsec with DynDNS is configured on the local device, the own IP address is propagated first and then the ISDN call is sent to the remote device. This ensures that the remote device can actually reach the local device if it initiates the tunnel setup.

### Transfer of IP Address over ISDN

Transferring the IP address of a device over ISDN (in the D channel and/or B channel) opens up new possibilities for the configuration of IPsec VPNs. This enables restrictions that occur in IPsec configuration with dynamic IP addresses to be avoided.



#### Note

To use the IP address transfer over ISDN function, you must obtain a free-of-charge extra licence.

You can obtain the licence data for extra licences via the online licensing pages in the support section at [www.bintec-elmeg.com](http://www.bintec-elmeg.com). Please follow the online licensing instructions.

Before System Software Release 7.1.4, IPsec ISDN callback only supported tunnel setup if



the current IP address of the initiator could be determined by indirect means (e.g. via DynDNS). However, DynDNS has serious disadvantages, such as the latency until the IP address is actually updated in the database. This can mean that the IP address propagated via DynDNS is not correct. This problem is avoided by transferring the IP address over ISDN. This type of transfer of dynamic IP addresses also enables the more secure ID Protect mode (main mode) to be used for tunnel setup.

Method of operation: Various modes are available for transferring your own IP address to the peer: The address can be transferred free in the D channel or in the B channel, but here the call must be accepted by the remote station and therefore incurs costs. If a peer whose IP address has been assigned dynamically wants to arrange for another peer to set up an IPsec tunnel, it can transfer its own IP address as per the settings described in [Fields in the menu IPv4 IPsec Callback](#) on page 440. Not all transfer modes are supported by all telephone companies. If you are not sure, automatic selection by the device can be used to ensure that all the available possibilities can be used.



#### Note

The callback configuration should be the same on the two devices so that your device is able to identify the IP address information from the called peer.

The following roles are possible:

- One side takes on the active role, the other the passive role.
- Both sides can take on both roles (both).

The IP address transfer and the start of IKE phase 1 negotiation take place in the following steps:

- (1) Peer A (the callback initiator) sets up a connection to the Internet in order to be assigned a dynamic IP address and be reachable for peer B over the Internet.
- (2) Your device creates a token with a limited validity and saves it together with the current IP address in the MIB entry belonging to peer B.
- (3) Your device sends the initial ISDN call to peer B, which transfers the IP address of peer A and the token as per the callback configuration.
- (4) Peer B extracts the IP address of peer A and the token from the ISDN call and assigns them to peer A based on the calling party number configured (the ISDN number used by peer A to send the initial call to peer B).
- (5) The IPsec Daemon at peer B's device can use the transferred IP address to initiate phase 1 negotiation with peer A. Here the token is returned to peer A in part of the payload in IKE negotiation.
- (6) Peer A is now able to compare the token returned by peer B with the entries in the

MIB and so identify the peer without knowing its IP address.

As peer A and peer B can now mutually identify each other, negotiations can also be conducted in the ID Protect mode using preshared keys.



#### Note

In some countries (e.g. Switzerland), the call in the D channel can also incur costs. An incorrect configuration at the called side can mean that the called side opens the B channel the calling side incurs costs.

The following options are only available on devices with an ISDN connection:

#### Fields in the menu IPv4 IPsec Callback

Field	Description
<b>Mode</b>	<p>Select the Callback Mode.</p> <p>Possible values:</p> <ul style="list-style-type: none"> <li>• <i>Inactive</i> (default value): IPsec callback is deactivated. The local device neither reacts to incoming ISDN calls nor initiates ISDN calls to the remote device.</li> <li>• <i>Passive</i>: The local device only reacts to incoming ISDN calls and, if necessary, initiates setting up an IPsec tunnel to the peer. No ISDN calls are sent to the remote device to cause this to set up an IPsec tunnel.</li> <li>• <i>Active</i>: The local device sends an ISDN call to the remote device to cause this to set up an IPsec tunnel. The device does not react to incoming ISDN calls.</li> <li>• <i>Both</i>: Your device can react to incoming ISDN calls and send ISDN calls to the remote device. The setting up of an IPsec tunnel is executed (after an incoming ISDN call) and initiated (by an outgoing ISDN call).</li> </ul>
<b>Incoming Phone Number</b>	<p>Only for <b>Mode</b> = <i>Passive</i> or <i>Both</i></p> <p>Enter the ISDN number from which the remote device calls the local device (calling party number). Wildcards may also be used.</p>
<b>Outgoing Phone Number</b>	<p>Only for <b>Mode</b> = <i>Active</i> or <i>Both</i></p>

Field	Description
	Enter the ISDN number with which the local device calls the remote device calls (called party number). Wildcards may also be used.
<b>Transfer own IP address over ISDN/GSM</b>	<p>Select whether the IP address of your own device is to be transferred over ISDN for IPsec callback.</p> <p>The function is enabled with <i>Enabled</i>.</p> <p>The function is disabled by default.</p>
<b>Transfer Mode</b>	<p>Only for <b>Transfer own IP address over ISDN/GSM</b> = enabled</p> <p>Select the mode in which your device is to attempt to transfer its IP address to the peer.</p> <p>Possible values:</p> <ul style="list-style-type: none"> <li>• <i>Autodetect best mode</i>: Your device automatically determines the most favourable mode. It first tries all D channel modes before switching to the B channel. (Costs are incurred for using the B channel.)</li> <li>• <i>Autodetect only D Channel Modes</i>: Your device automatically determines the most favourable D channel mode. The use of the B channel is excluded.</li> <li>• <i>Use specific D Channel Mode</i>: Your device tries to transfer the IP address in the mode set in the <b>Mode</b> field.</li> <li>• <i>Try specific D Channel Mode, fall back to B Channel</i>: Your device tries to transfer the IP address in the mode set in the <b>Mode</b> field. If this does not succeed, the IP address is transferred in the B channel. (This incurs costs.)</li> <li>• <i>Use only B Channel Mode</i>: Your device transfers the IP address in the B channel. This incurs costs.</li> </ul>
<b>D Channel Mode</b>	<p>Only for <b>Transfer Mode</b> = <i>Use specific D Channel Mode</i> or <i>Try specific D Channel Mode, fall back to B Channel</i></p> <p>Select the D channel mode in which your device tries to transfer the IP address.</p> <p>Possible values:</p>

Field	Description
	<ul style="list-style-type: none"> <li>• <i>LLC</i> (default value): The IP address is transferred in the "LLC information elements" of the D channel.</li> <li>• <i>SUBADDR</i>: The IP address is transferred in the subaddress "information elements" of the D channel.</li> <li>• <i>LLC and SUBADDR</i>: The IP address is transferred in both the "LLC" and "subaddress information elements".</li> </ul>

## 19.1.2 Phase-1 Profiles

A list of all configured tunnel profiles is displayed in the **VPN->IPSec->Phase-1 Profiles** menu.

In the **Default** column, you can mark the profile to be used as the default profile.

### 19.1.2.1 New

Choose the **New** (at **Create new IKEv1 Profile** or **Create new IKEv2 Profile**) button to create additional profiles.

The menu **VPN->IPSec->Phase-1 Profiles->New** consists of the following fields:

#### Fields in the Phase-1 (IKE) Parameters menu.

Field	Description
<b>Description</b>	Enter a description that uniquely defines the type of rule.
<b>Proposals</b>	<p>In this field, you can select any combination of encryption and message hash algorithms for IKE phase 1 on your device. The combination of six encryption algorithms and four message hash algorithms gives 24 possible values in this field. At least one proposal must exist. Therefore the first line of the table cannot be deactivated.</p> <p>Encryption algorithms (<b>Encryption</b>):</p> <ul style="list-style-type: none"> <li>• <i>3DES</i> (default value): 3DES is an extension of the DES algorithm with an effective key length of 112 bits, which is rated as secure. It is the slowest algorithm currently supported.</li> <li>• <i>Twofish</i>: Twofish was a final candidate for the AES (Advanced Encryption Standard). It is rated as just as secure as Rijndael (AES), but is slower.</li> </ul>

Field	Description
	<ul style="list-style-type: none"> <li>• <i>Blowfish</i>: Blowfish is a very secure and fast algorithm. Twofish can be regarded as the successor to Blowfish.</li> <li>• <i>CAST</i>: CAST is also a very secure algorithm, marginally slower than Blowfish, but faster than 3DES.</li> <li>• <i>DES</i>: DES is an older encryption algorithm, which is rated as weak due to its small effective length of 56 bits.</li> <li>• <i>AES</i>: Rijndael has been nominated as AES due to its fast key setup, low memory requirements, high level of security against attacks and general speed. The partner's AES key length is used here. If this has also selected the parameter <i>AES</i> , a key length of 128 bits is used.</li> <li>• <i>AES-128</i>: Rijndael has been nominated as AES due to its fast key setup, low memory requirements, high level of security against attacks and general speed. Here, it is used with a key length of 128 bits.</li> <li>• <i>AES-192</i>: Rijndael has been nominated as AES due to its fast key setup, low memory requirements, high level of security against attacks and general speed. Here, it is used with a key length of 192 bits.</li> <li>• <i>AES-256</i>: Rijndael has been nominated as AES due to its fast key setup, low memory requirements, high level of security against attacks and general speed. Here, it is used with a key length of 256 bits.</li> </ul> <p>Hash algorithms (<b>Authentication</b>):</p> <ul style="list-style-type: none"> <li>• <i>MD5</i> (default value): MD5 (Message Digest #5) is an older hash algorithm. It is used with a 96 bit digest length for IPSec.</li> <li>• <i>SHA1</i>: SHA1 (Secure Hash Algorithm #1) is a hash algorithm developed by NSA (United States National Security Association). It is rated as secure, but is slower than MD5. It is used with a 96 bit digest length for IPSec.</li> <li>• <i>RipeMD 160</i>: RipeMD 160 is a 160 bit hash algorithm. It is used as a secure replacement for MD5 and RipeMD.</li> <li>• <i>Tiger192</i>: Tiger 192 is a relatively new and very fast algorithm.</li> <li>• <i>SHA2-256</i>: SH2 (Secure Hash Algorithmus #2) is a hash algorithm which has been designed to supersede SHA 1. It can be used with hash lengths of 256, 384 or 512 bits.</li> <li>• <i>SHA2-384</i>: SHA-2 with 384 bit hash length.</li> </ul>

Field	Description
	<ul style="list-style-type: none"> <li>• <i>SHA2-512</i>: SHA-2 with 512 bit hash length.</li> </ul> <p>Depending on the hardware of your device some options may not be available.</p> <p>Please note that the quality of the algorithms is subject to relative aspects and may change due to mathematical or cryptographic developments.</p>
<b>DH Group</b>	<p>The Diffie-Hellman group defines the parameter set used as the basis for the key calculation during phase 1. "MODP" as supported by bintec elmeg devices stands for "modular exponentiation".</p> <p>The following groups with their corresponding bit values are available:</p> <ul style="list-style-type: none"> <li>• <i>1 (768 Bit)</i></li> <li>• <i>2 (1024 Bit)</i></li> <li>• <i>5 (1536 Bit)</i></li> <li>• <i>14 (2048 Bit)</i></li> <li>• <i>15 (3072 Bit)</i></li> <li>• <i>16 (4096 Bit)</i></li> </ul> <p>Depending on the hardware of your device some options may not be available.</p>
<b>Lifetime</b>	<p>Create a lifetime for phase 1 keys.</p> <p>The following options are available for defining the <b>Lifetime</b>:</p> <ul style="list-style-type: none"> <li>• Input in <b>Seconds</b>: Enter the lifetime for phase 1 key in seconds. The value can be a whole number from 0 to 2147483647. The default value is <i>14400</i>, which means the key must be renewed once four hours have elapsed.</li> <li>• Input in <b>kBytes</b>: Enter the lifetime for phase 1 keys as amount of data processed in kBytes. The value can be a whole number from 0 to 2147483647. The default value is <i>0</i>, which means that the number of transmitted kBytes is irrelevant.</li> </ul>
<b>Authentication Method</b>	<p>Only for <b>Phase-1 (IKE) Parameters</b></p> <p>Select the authentication method.</p>

Field	Description
	<p>Possible values:</p> <ul style="list-style-type: none"> <li>• <i>Preshared Keys</i> (default value): If you do not use certificates for the authentication, you can select Preshared Keys. These are configured during peer configuration in the <b>VPN-&gt;IPSec-&gt;IPSec Peers</b>. The preshared key is the shared password.</li> <li>• <i>DSA Signature</i>: Phase 1 key calculations are authenticated using the DSA algorithm.</li> <li>• <i>RSA Signature</i>: Phase 1 key calculations are authenticated using the RSA algorithm.</li> <li>• <i>RSA Encryption</i>: In RSA encryption the ID payload is also encrypted for additional security.</li> </ul>
<b>Local Certificate</b>	<p>Only for <b>Phase-1 (IKE) Parameters</b></p> <p>Only for <b>Authentication Method</b> = <i>DSA Signature</i>, <i>RSA Signature</i> or <i>RSA Encryption</i></p> <p>This field enables you to select one of your own certificates for authentication. It shows the index number of this certificate and the name under which it is saved. This field is only shown for authentication settings based on certificates and indicates that a certificate is essential.</p>
<b>Mode</b>	<p>Only for <b>Phase-1 (IKE) Parameters</b></p> <p>Select the phase 1 mode.</p> <p>Possible values:</p> <ul style="list-style-type: none"> <li>• <i>Aggressive</i> (default value): The Aggressive Mode is necessary if one of the peers does not have a static IP address and preshared keys are used for authentication. It requires only three messages to configure a secure channel.</li> <li>• <i>Main Mode (ID Protect)</i>: This mode (also designated Main Mode) requires six messages for a Diffie-Hellman key calculation and thus for configuring a secure channel, over which the IPSec SAs can be negotiated. A condition is that both peers have static IP addresses if preshared keys are used for authentication.</li> </ul> <p>Also define whether the selected mode is used exclusively</p>

Field	Description
	<b>Strict</b> ), or the peer can also propose another mode.
<b>Local ID Type</b>	<p>Only for <b>Phase-1 (IKE) Parameters</b></p> <p>Select the local ID type.</p> <p>Possible values:</p> <ul style="list-style-type: none"> <li>• <i>Fully Qualified Domain Name (FQDN)</i></li> <li>• <i>E-mail Address</i></li> <li>• <i>IPV4 Address</i></li> <li>• <i>ASN.1-DN (Distinguished Name)</i></li> </ul>
<b>Local ID Value</b>	<p>Only for <b>Phase-1 (IKE) Parameters</b></p> <p>Enter the ID of your device.</p> <p>For <b>Authentication Method</b> = <i>DSA Signature, RSA Signature</i> or <i>RSA Encryption</i> the <b>Use Subject Name from certificate</b> option is displayed.</p> <p>When you enable the <b>Use Subject Name from certificate</b> option, the first alternative subject name indicated in the certificate is used, or, if none is specified, the subject name of the certificate is used.</p> <p>Note: If you use certificates for authentication and your certificate contains alternative subject names (see <a href="#">Certificates</a> on page 77), you must make sure your device selects the first alternative subject name by default. Make sure you and your peer both use the same name, i.e. that your local ID and the peer ID your partner configures for you are identical.</p>

### Alive Check

During communication between two IPSec peers, one of the peers may become unavailable, e.g. due to routing problems or a reboot. However, this can only be detected when the end of the lifetime of the security connection is reached. Up until this point the data packets are lost. These are various methods of performing an alive check to prevent this happening. In the **Alive Check** field you can specify whether a method should be used to check the availability of a peer.

Two methods are available: Heartbeats and Dead Peer Detection.



The menu **Advanced Settings** consists of the following fields:

#### Fields in the **Advanced Settings** menu.

Field	Description
<b>Alive Check</b>	<p>Only for <b>Phase-1 (IKE) Parameters</b></p> <p>Select the method to be used to check the functionality of the IPsec connection.</p> <p>In addition to the default method Dead Peer Detection (DPD), the (proprietary) Heartbeat method is implemented. This sends and receives signals every 5 seconds, depending on the configuration. If these signals are not received after 20 seconds, the SA is discarded as invalid.</p> <p>Possible values:</p> <ul style="list-style-type: none"> <li>• <i>Autodetect</i> (default value): Your device detects and uses the mode supported by the remote terminal.</li> <li>• <i>Inactive</i>: Your device sends and expects no heartbeat. Set this option if you use devices from other manufacturers.</li> <li>• <i>Heartbeats (Expect only)</i>: Your device expects a heartbeat from the peer but does not send one itself.</li> <li>• <i>Heartbeats (Send only)</i>: Your device expects no heartbeat from the peer, but sends one itself.</li> <li>• <i>Heartbeats (Send &amp;Expect)</i>: Your device expects a heartbeat from the peer and sends one itself.</li> <li>• <i>Dead Peer Detection</i>: Use DPD (dead peer detection) in accordance with RFC 3706. DPD uses a request-reply protocol to check the availability of the remote terminal and can be configured independently on both sides. This option only checks the availability of the peer if data is to be sent to it.</li> <li>• <i>Dead Peer Detection (Idle)</i>: Use DPD (dead peer detection) in accordance with RFC 3706. DPD uses a request-reply protocol to check the availability of the remote terminal and can be configured independently on both sides. This option is used to carry out a check at certain intervals depending on forthcoming data transfers.</li> </ul> <p>Only for <b>Phase-1 (IKEv2) Parameters</b></p> <p>Enable or disable alive check.</p>

Field	Description
	The function is enabled by default.
<b>Block Time</b>	<p>Define how long a peer is blocked for tunnel setups after a phase 1 tunnel setup has failed. This only affects locally initiated setup attempts.</p> <p>Possible values are <i>-1</i> to <i>86400</i> (seconds); <i>-1</i> means the value in the default profile is used and <i>0</i> means that the peer is never blocked.</p> <p>The default value is <i>30</i>.</p>
<b>NAT Traversal</b>	<p>NAT Traversal (NAT-T) also enables IPsec tunnels to be opened via one or more devices on which network address translation (NAT) is activated.</p> <p>Without NAT-T, incompatibilities may arise between IPsec and NAT (see RFC 3715, section 2). These primarily prevent the setup of an IPsec tunnel from a host within a LANs and behind a NAT device to another host or device. NAT-T enables these kinds of tunnels without conflicts with NAT device, activated NAT is automatically detected by the IPsec Daemon and NAT-T is used.</p> <p>Only for <i>IKEv1 profiles</i></p> <p>Possible values:</p> <ul style="list-style-type: none"> <li>• <i>Enabled</i> (default value): NAT Traversal is enabled.</li> <li>• <i>Disabled</i>: NAT Traversal is disabled.</li> <li>• <i>Force</i>: The device always behaves as it would if NAT were in use.</li> </ul> <p>Only for <i>IKEv2 profiles</i></p> <p>The function is enabled with <i>Enabled</i>.</p> <p>The function is enabled by default.</p>
<b>CA Certificates</b>	<p>Only for <b>Phase-1 (IKE) Parameters</b></p> <p>Only for <b>Authentication Method</b> = <i>DSA Signature, RSA Signature</i> or <i>RSA Encryption</i></p> <p>If you enable the <b>Trust the following CA certificates</b> option,</p>

Field	Description
	<p>you can select up to three CA certificates that are accepted for this profile.</p> <p>This option can only be configured if certificates are loaded.</p>

### 19.1.3 Phase-2 Profiles

You can define profiles for phase 2 of the tunnel setup just as for phase 1.

In the **VPN->IPSec->Phase-2 Profiles** menu, a list of all configured IPsec phase 2 profiles is displayed.

In the **Default** column, you can mark the profile to be used as the default profile.

#### 19.1.3.1 New

Choose the **New** button to create additional profiles.

The menu **VPN->IPSec->Phase-2 Profiles->New** consists of the following fields:

#### Fields in the Phase-2 (IPSEC) Parameters menu.

Field	Description
<b>Description</b>	<p>Enter a description that uniquely identifies the profile.</p> <p>The maximum length of the entry is 255 characters.</p>
<b>Proposals</b>	<p>In this field, you can select any combination of encryption and message hash algorithms for IKE phase 2 on your default. The combination of six encryption algorithms and two message hash algorithms gives 12 possible values in this field.</p> <p>Encryption algorithms (<b>Encryption</b>):</p> <ul style="list-style-type: none"> <li>• <i>3DES</i> (default value): 3DES is an extension of the DES algorithm with an effective key length of 112 bits, which is rated as secure. It is the slowest algorithm currently supported.</li> <li>• <i>-- ALL --</i>: All options can be used.</li> <li>• <i>AES</i>: Rijndael has been nominated as AES due to its fast key setup, low memory requirements, high level of security against attacks and general speed. The partner's AES key length is used here. If this has also selected the parameter <i>AES</i> , a key length of 128 bits is used.</li> </ul>

Field	Description
	<ul style="list-style-type: none"> <li>• <i>AES-128</i>: Rijndael has been nominated as AES due to its fast key setup, low memory requirements, high level of security against attacks and general speed. Here, it is used with a key length of 128 bits.</li> <li>• <i>AES-192</i>: Rijndael has been nominated as AES due to its fast key setup, low memory requirements, high level of security against attacks and general speed. Here, it is used with a key length of 192 bits.</li> <li>• <i>AES-256</i>: Rijndael has been nominated as AES due to its fast key setup, low memory requirements, high level of security against attacks and general speed. Here, it is used with a key length of 256 bits.</li> <li>• <i>Twofish</i>: Twofish was a final candidate for the AES (Advanced Encryption Standard). It is rated as just as secure as Rijndael (AES), but is slower.</li> <li>• <i>Blowfish</i>: Blowfish is a very secure and fast algorithm. Twofish can be regarded as the successor to Blowfish.</li> <li>• <i>CAST</i>: CAST is also a very secure algorithm, marginally slower than Blowfish, but faster than 3DES.</li> <li>• <i>DES</i>: DES is an older encryption algorithm, which is rated as weak due to its small effective length of 56 bits.</li> </ul> <p>Hash algorithms (<b>Authentication</b>):</p> <ul style="list-style-type: none"> <li>• <i>MD5</i> (default value): MD5 (Message Digest #5) is an older hash algorithm. It is used with a 96 bit digest length for IPsec.</li> <li>• <i>-- ALL --</i>: All options can be used.</li> <li>• <i>SHA1</i>: SHA1 (Secure Hash Algorithm #1) is a hash algorithm developed by NSA (United States National Security Association). It is rated as secure, but is slower than MD5. It is used with a 96 bit digest length for IPsec.</li> <li>• <i>SHA2-256</i>: SH2 (Secure Hash Algorithmus #2) is a hash algorithm which has been designed to supersede SHA 1. It can be used with hash lengths of 256, 384 or 512 bits.</li> <li>• <i>SHA2-384</i>: SHA-2 with 384 bit hash length.</li> <li>• <i>SHA2-512</i>: SHA-2 with 512 bit hash length.</li> </ul> <p>Note that RipeMD 160 and Tiger 192 are not available for message hashing in phase 2.</p>

Field	Description
	Depending on the hardware of your device some options may not be available.
<b>Use PFS Group</b>	<p>As PFS (Perfect Forward Secrecy) requires another Diffie-Hellman key calculation to create new encryption material, you must select the exponentiation features. If you enable PFS (<i>Enabled</i>), the options are the same as for the configuration of <b>DH Group</b> in the <b>VPN-&gt;IPSec-&gt;Phase-1 Profiles</b> menu. PFS is used to protect the keys of a renewed phase 2 SA, even if the keys of the phase 1 SA have become known.</p> <p>The following groups with their corresponding bit values are available:</p> <ul style="list-style-type: none"> <li>• 1 (768 Bit)</li> <li>• 2 (1024 Bit)</li> <li>• 5 (1536 Bit)</li> <li>• 14 (2048 Bit)</li> <li>• 15 (3072 Bit)</li> <li>• 16 (4096 Bit)</li> </ul> <p>Depending on the hardware of your device some options may not be available.</p>
<b>Lifetime</b>	<p>Define how the lifetime is defined that will expire before phase 2 SAs need to be renewed.</p> <p>The new SAs are negotiated shortly before expiry of the current SAs. As for RFC 2407, the default value is eight hours, which means the key must be renewed once eight hours have elapsed.</p> <p>The following options are available for defining the <b>Lifetime</b>:</p> <ul style="list-style-type: none"> <li>• Input in <b>Seconds</b>: Enter the lifetime for phase 2 key in seconds. The value can be a whole number from 0 to 2147483647. The default value is 7200.</li> <li>• Input in <b>kBytes</b>: Enter the lifetime for phase 2 keys as amount of data processed in kBytes. The value can be a whole number from 0 to 2147483647. The default value is 0.</li> </ul> <p><b>Rekey after</b>: Specify the percentage in the course of the lifetime</p>

Field	Description
	<p>at which the phase 2 keys are to be regenerated.</p> <p>The percentage entered is applied to both the lifetime in seconds and the lifetime in kBytes.</p> <p>The default value is <i>80 %</i>.</p>

The menu **Advanced Settings** consists of the following fields:

#### Fields in the **Advanced Settings** menu.

Field	Description
<b>IP Compression</b>	<p>Select whether compression is to be activated before data encryption. If data is compressed effectively, this can result in higher performance and a lower volume of data to be transferred. In the case of fast lines or data that cannot be compressed, you are advised against using this option as the performance can be significantly affected by the increased effort during compression.</p> <p>The function is enabled with <i>Enabled</i>.</p> <p>The function is disabled by default.</p>
<b>Alive Check</b>	<p>Select whether and how IPSec heartbeats are used.</p> <p>A bintec elmeg IPSec heartbeat is implemented to determine whether or not a Security Association (SA) is still valid. This function sends and receives signals every 5 seconds, depending on the configuration. If these signals are not received after 20 seconds, the SA is discarded as invalid.</p> <p>Possible values:</p> <ul style="list-style-type: none"> <li>• <i>Autodetect</i> (default value): Automatic detection of whether the remote terminal is a bintec elmeg device. If it is, <i>Heartbeats (Send &amp; Expect)</i> (for a remote terminal with bintec elmeg) or <i>Inactive</i> (for a remote terminal without bintec elmeg) is set.</li> <li>• <i>Inactive</i>: Your device sends and expects no heartbeat. Set this option if you use devices from other manufacturers.</li> <li>• <i>Heartbeats (Expect only)</i>: Your device expects a heartbeat from the peer but does not send one itself.</li> <li>• <i>Heartbeats (Send only)</i>: Your device expects no heart-</li> </ul>

Field	Description
	<p>beat from the peer, but sends one itself.</p> <ul style="list-style-type: none"> <li>• <i>Heartbeats (Send &amp;Expect)</i>: Your device expects a heartbeat from the peer and sends one itself.</li> </ul>
<b>Propagate PMTU</b>	<p>Select whether the PMTU (Path Maximum Transfer Unit) is to be propagated during phase 2.</p> <p>The function is enabled with <i>Enabled</i>.</p> <p>The function is enabled by default.</p>

## 19.1.4 XAUTH Profiles

In the **XAUTH Profiles** menu a list of all XAUTH profiles is displayed.

Extended Authentication for IPSec (XAuth) is an additional authentication method for IPSec tunnel users.

The gateway can take on two different roles when using XAuth as it can act as a server or as a client:

- As a server the gateway requires a proof of authorisation.
- As a client the gateway provides proof of authorisation.

In server mode multiple users can obtain authentication via XAuth, e.g. users of Apple iPhones. Authorisation is verified either on the basis of a list or via a Radius Server. If using a one time password (OTP), the password check can be carried out by a token server (e.g. SecOVID from Kobil), which is installed behind the Radius Server. If a company's headquarters is connected to several branches via IPSec, several peers can be configured. A specific user can then use the IPSec tunnel over various peers depending on the assignment of various profiles. This is useful, for example, if an employee works alternately in different branches, if each peer represents a branch and if the employee wishes to have on-site access to the tunnel.

XAuth is carried out once IPSec IKE (Phase 1) has been completed successfully and before IKE (Phase 2) begins.

If XAuth is used together with IKE Config Mode, the transactions for XAuth are carried out before the transactions for IKE Config Mode.

### 19.1.4.1 New

Choose the **New** button to create additional profiles.

The **VPN->IPSec->XAUTH Profiles->New** menu consists of the following fields:

**Fields in the Basic Parameters menu.**

Field	Description
<b>Description</b>	Enter a description for this XAuth profile.
<b>Role</b>	Select the role of the gateway for XAuth authentication.  Possible values: <ul style="list-style-type: none"> <li>• <i>Server</i> (default value): The gateway requires a proof of authorisation.</li> <li>• <i>Client</i>: The gateway provides proof of authorisation.</li> </ul>
<b>Mode</b>	Only for <b>Role</b> = <i>Server</i>  Select how authentication is carried out.  Possible values: <ul style="list-style-type: none"> <li>• <i>RADIUS</i> (default value): Authentication is carried out via a Radius server. It is configured in the <b>System Management-&gt;Remote Authentication-&gt;RADIUS</b> menu and selected in the <b>RADIUS Server Group ID</b> field.</li> <li>• <i>Local</i>: Authentication is carried out via a local list.</li> </ul>
<b>Name</b>	Only for <b>Role</b> = <i>Client</i>  Enter the authentication name of the client.
<b>Password</b>	Only for <b>Role</b> = <i>Client</i>  Enter the authentication password.
<b>RADIUS Server Group ID</b>	Only for <b>Role</b> = <i>Server</i>  Select the desired list in <b>System Management-&gt;Remote Authentication-&gt;RADIUS</b> configured RADIUS group.
<b>Users</b>	Only for <b>Role</b> = <i>Server</i> and <b>Mode</b> = <i>Local</i>  If your gateway is configured as an XAuth server, the clients can be authenticated via a locally configured user list. Define



Field	Description
	the members of the user group of this XAUTH profile here by entering the authentication name of the client ( <b>Name</b> ) and the authentication password ( <b>Password</b> ). Add new members with <b>Add</b> .

## 19.1.5 IP Pools

In the **IP Pools** menu a list of all IP pools for your configured IPSec connections is displayed.

If for an IPSec peer you have set **IP Address Assignment** *IKE Config Mode Server*, you must define the IP pools here from which the IP addresses are assigned.

### 19.1.5.1 Edit or New

Choose the **New** button to set up new IP address pools. Choose the  icon to edit existing entries.

#### Fields in the menu **Basic Parameters**

Field	Description
<b>IP Pool Name</b>	Enter any description to uniquely identify the IP pool.
<b>IP Address Range</b>	Enter the first (first field) and last (second field) IP address of the IP address pool.
<b>DNS Server</b>	<p><b>Primary:</b> Enter the IP address of the DNS server that is to be used, preferably, by clients who draw an address from this pool.</p> <p><b>Secondary:</b> Optionally, enter the IP address of an alternative DNS server.</p>

## 19.1.6 Options

The menu **VPN->IPSec->Options** consists of the following fields:

#### Fields in the **Global Options** menu.

Field	Description
<b>Enable IPSec</b>	Select whether you want to activate IPSec.

Field	Description
	<p>The function is enabled with <i>Enabled</i>.</p> <p>The function is active as soon as an IPSec Peer is configured.</p>
<b>Delete complete IPSec configuration</b>	<p>If you click the  icon, delete the complete IPSec configuration of your device.</p> <p>This cancels all settings made during the IPSec configuration. Once the configuration is deleted, you can start with a completely new IPSec configuration.</p> <p>You can only delete the configuration if <b>Enable IPSec</b> = not activated.</p>
<b>IPSec Debug Level</b>	<p>Select the priority of the syslog messages of the IPSec subsystem to be recorded internally.</p> <p>Possible values:</p> <ul style="list-style-type: none"> <li>• <i>Emergency</i> (highest priority)</li> <li>• <i>Alert</i></li> <li>• <i>Critical</i></li> <li>• <i>Error</i></li> <li>• <i>Warning</i></li> <li>• <i>Notice</i></li> <li>• <i>Information</i></li> <li>• <i>Debug</i> (default value, lowest priority)</li> </ul> <p>Syslog messages are only recorded internally if they have a higher or identical priority to that indicated, i.e. all messages generated are recorded at syslog level "debug".</p>

The **Advanced Settings** menu is for adapting certain functions and features to the special requirements of your environment, i.e. mostly interoperability flags are set. The default values are globally valid and enable your system to work correctly to other bintec elmeg devices, so that you only need to change these values if the remote terminal is a third-party product or you know special settings are necessary. These may be needed, for example, if the remote end operates with older IPSec implementations.

The menu **Advanced Settings** consists of the following fields:

**Fields in the Advanced Settings menu.**

Field	Description
<b>IPSec over TCP</b>	<p>Determine whether IPSec over TCP is to be used.</p> <p>IPSec over TCP is based on NCP pathfinder technology. This technology insures that data traffic (IKE, ESP, AH) between peers is integrated into a pseudo HTTPS session.</p> <p>The function is enabled with <i>Enabled</i>.</p> <p>The function is disabled by default.</p>
<b>Send Initial Contact Message</b>	<p>Select whether IKE Initial Contact messages are to be sent during IKE (phase 1) if no SAs with a peer exist.</p> <p>The function is enabled with <i>Enabled</i>.</p> <p>The function is enabled by default.</p>
<b>Sync SAs with ISP interface state</b>	<p>Select whether all SAs are to be deleted whose data traffic was routed via an interface on which the status has changed from <i>Up</i> to <i>Down</i>, <i>Dormant</i> or <i>Blocked</i>.</p> <p>The function is enabled with <i>Enabled</i>.</p> <p>The function is disabled by default.</p>
<b>Use Zero Cookies</b>	<p>Select whether zeroed ISAKMP Cookies are to be sent.</p> <p>These are equivalent to the SPI (Security Parameter Index) in IKE proposals; as they are redundant, they are normally set to the value of the negotiation currently in progress. Alternatively, your device can use zeroes for all values of the cookie. In this case, select <i>Enabled</i>.</p>
<b>Zero Cookie Size</b>	<p>Only for <b>Use Zero Cookies</b> = enabled.</p> <p>Enter the length in bytes of the zeroed SPI used in IKE proposals.</p> <p>The default value is <i>32</i>.</p>
<b>Dynamic RADIUS Authentication</b>	<p>Select whether RADIUS authentication is to be activated via IPSec.</p> <p>The function is enabled with <i>Enabled</i>.</p>

Field	Description
	The function is disabled by default.

#### Fields in the PKI Handling Options menu.

Field	Description
<b>Ignore Certificate Request Payloads</b>	<p>Select whether certificate requests received from the remote end during IKE (phase 1) are to be ignored.</p> <p>The function is enabled with <i>Enabled</i>.</p> <p>The function is disabled by default.</p>
<b>Send Certificate Request Payloads</b>	<p>Select whether certificate requests are to be sent during IKE (phase 1).</p> <p>The function is enabled with <i>Enabled</i>.</p> <p>The function is enabled by default.</p>
<b>Send Certificate Chains</b>	<p>Select whether complete certificate chains are to be sent during IKE (phase 1).</p> <p>The function is enabled with <i>Enabled</i>.</p> <p>The function is enabled by default.</p> <p>Deactivate this function if you do not wish to send the peer the certificates of all levels (from your level to the CA level).</p>
<b>Send CRLs</b>	<p>Select whether CRLs are to be sent during IKE (phase 1).</p> <p>The function is enabled with <i>Enabled</i>.</p> <p>The function is disabled by default.</p>
<b>Send Key Hash Payloads</b>	<p>Select whether key hash payloads are to be sent during IKE (phase 1).</p> <p>In the default setting, the public key hash of the remote end is sent together with the other authentication data. Only applies for RSA encryption. Activate this function with <i>Enabled</i> to suppress this behaviour.</p>

## 19.2 be.IP Secure Client

Here you can download the current Secure IPsec Client software for free.

## Chapter 20 Firewall

The Stateful Inspection Firewall (SIF) provided for bintec elmeg gateways is a powerful security feature.

The SIF with dynamic packet filtering has a decisive advantage over static packet filtering: The decision whether or not to send a packet cannot be made solely on the basis of source and destination addresses or ports but also using dynamic packet filtering based on the state of the connection to a partner.

This means packets that belong to an already active connection can also be forwarded. The SIF also accepts packets that belong to an "affiliated connection". The negotiation of an FTP connection takes place over port 21, for example, but the actual data exchange can take place over a completely different port.

### SIF and other security features

The Stateful Inspection Firewall fits into the existing security architecture of bintec elmeg. The configuration work for the SIF is comparatively straightforward with systems like Network Address Translation (NAT) and IP Access Lists (IPAL).

As SIF, NAT and IPAL are active in the system simultaneously, attention must be given to possible interaction: If any packet is rejected by one of the security instances, this is done immediately. This is irrelevant whether another instance would accept it or not. Your need for security features should therefore be accurately analysed.

The essential difference between SIF and NAT/IPAL is that the rules for the SIF are generally applied globally, i.e. not restricted to one interface.

In principle, the same filter criteria are applied to the data traffic as those used in NAT and IPAL:

- Source and destination address of the packet (with an associated netmask)
- Service (preconfigured, e.g. Echo, FTP, HTTP)
- Protocol
- Port number(s)

To illustrate the differences in packet filtering, a list of the individual security instances and their method of operation is given below.

### NAT

One of the basic functions of NAT is the translation of the local IP addresses of your LAN into the global IP addresses you are assigned by your ISP and vice versa. All connections initiated externally are first blocked, i.e. every packet your device cannot assign to an existing connection is rejected. This means that a connection can only be set up from inside to outside. Without explicit permission, NAT rejects every access from the WAN to the LAN.

## IP Access Lists

Here, packets are allowed or rejected exclusively on the basis of the criteria listed above, i.e. the state of the connection is not considered (except for **Services** = *TCP*).

## SIF

The SIF sorts out all packets that are not explicitly or implicitly allowed. The result can be a "deny", in which case no error message is sent to the sender of the rejected packet, or a "reject", where the sender is informed of the packet rejection.

The incoming packets are processed as follows:

- The SIF first checks if an incoming packet can be assigned to an existing connection. If so, it is forwarded. If the packet cannot be assigned to an existing connection, a check is made to see if a suitable connection is expected (e.g. as affiliated connection of an existing connection). If so, the packet is also accepted.
- If the packet cannot be assigned to any existing or expected connection, the SIF filter rules are applied: If a deny rule matches the packet, the packet is discarded without sending an error message to the sender of the packet; if a reject rule matches, the packet is discarded and an ICMP Host Unreachable message sent to the sender of the packet. The packet is only forwarded if an accept rule matches.
- All packets without matching rules are rejected without sending an error message to the sender when all the existing rules have been checked (=default behaviour).

Specific instructions for the configuration of Stateful Inspection Firewall (SIF), see the end of the chapter [Configuration](#) on page 474.

## 20.1 Policies

## 20.1.1 IPv4 Filter Rules

The default behaviour with **Action** = *Access* consists of two implicit filter rules: If an incoming packet can be assigned to an existing connection and if a suitable connection is expected (e.g. such as an affiliated connection of an existing connection), the packet is allowed.

The sequence of filter rules in the list is relevant: The filter rules are applied to each packet in succession until a rule matches. If overlapping occurs, i.e. more than one filter rule matches a packet, only the first rule is executed. This means that if the first rule denies a packet, whereas a later rule allows it, the packet is rejected. A deny rule also has no effect if a relevant packet has previously been allowed by another filter rule.

The security concept is based on the assumption that an infrastructure consists of trusted and untrusted zones. The security policies *Trusted* and *Untrusted* describe this assumption. They define the filter rules **Trusted Interfaces** and **Untrusted Interfaces** which are created by default and cannot be deleted.

If you use the **Security Policy** *Trusted*, all data packets are accepted. You can create additional filter rules that discard specific packets. In the same way, you can allow specific packets when using the *Untrusted* policy.

A list of all configured filter rules is displayed in the **Firewall->Policies+IPv4 Filter Rules** menu.

Using the  button in the line **Trusted Interfaces**, you can determine which interfaces are **Trusted**. A new window opens with an interface list. You can mark individual interfaces as trusted.

You can use the  button to insert another policy above the list entry. The configuration menu for creating a new policy opens.

You can use the  button to move the list entry. A dialog box opens, in which you can select the position to which the policy is to be moved.

### 20.1.1.1 New

Choose the **New** button to create additional parameters.

The menu **Firewall->Policies+IPv4 Filter Rules->New** consists of the following fields:

**Fields in the Basic Parameters** menu.



Field	Description
<b>Source</b>	<p>Select one of the preconfigured aliases for the source of the packet.</p> <p>In the list, all WAN/LAN interfaces, interface groups (see <b>Firewall-&gt;Interfaces-&gt;Groups</b>), addresses (see <b>Firewall-&gt;Addresses-&gt;Address List</b>) and address groups (see <b>Firewall-&gt;Addresses-&gt;Groups</b>) are available.</p> <p>The value <i>Any</i> means that neither the source interface nor the source address is checked.</p>
<b>Destination</b>	<p>Select one of the preconfigured aliases for the destination of the packet.</p> <p>In the list, all WAN/LAN interfaces, interface groups (see <b>Firewall-&gt;Interfaces-&gt;Groups</b>), addresses (see <b>Firewall-&gt;Addresses-&gt;Address List</b>) and address groups (see <b>Firewall-&gt;Addresses-&gt;Groups</b>).</p> <p>The value <i>Any</i> means that neither the destination interface nor the destination address is checked.</p>
<b>Service</b>	<p>Select one of the preconfigured services to which the packet to be filtered must be assigned.</p> <p>The extensive range of services configured ex works includes the following:</p> <ul style="list-style-type: none"> <li>• <i>ftp</i></li> <li>• <i>telnet</i></li> <li>• <i>smtp</i></li> <li>• <i>dns</i></li> <li>• <i>http</i></li> <li>• <i>nntp</i></li> <li>• <i>Internet</i></li> <li>• <i>Netmeeting</i></li> </ul> <p>Additional services are created in <b>Firewall-&gt;Services-&gt;Service List</b>.</p> <p>In addition, the service groups configured in <b>Firewall-&gt;Services-&gt;Groups</b> can be selected.</p>

Field	Description
<b>Action</b>	<p>Select the action to be applied to a filtered packet.</p> <p>Possible values:</p> <ul style="list-style-type: none"> <li>• <i>Access</i> (default value): The packets are forwarded on the basis of the entries.</li> <li>• <i>Deny</i>: The packets are rejected.</li> <li>• <i>Reject</i>: The packets are rejected. An error message is issued to the sender of the packet.</li> </ul>

## 20.1.2 IPv6 Filter Rules

The default behaviour with **Action** = *Access* consists of two implicit filter rules: If an incoming packet can be assigned to an existing connection and if a suitable connection is expected (e.g. such as an affiliated connection of an existing connection), the packet is allowed.

The sequence of filter rules in the list is relevant: The filter rules are applied to each packet in succession until a rule matches. If overlapping occurs, i.e. more than one filter rule matches a packet, only the first rule is executed. This means that if the first rule denies a packet, whereas a later rule allows it, the packet is rejected. A deny rule also has no effect if a relevant packet has previously been allowed by another filter rule.

The security concept is based on the assumption that an infrastructure consists of trusted and untrusted zones. The security policies *Trusted* and *Untrusted* describe this assumption. They define the filter rules **Trusted Interfaces** and **Untrusted Interfaces** which are created by default and cannot be deleted.

If you use the **Security Policy** *Trusted*, all data packets are accepted. You can create additional filter rules that discard specific packets. In the same way, you can allow specific packets when using the *Untrusted* policy.

A list of all configured filter rules is displayed in the **Firewall->Policies->IPv6 Filter Rules** menu.

Using the  button in the line **Trusted Interfaces**, you can determine which interfaces are **Trusted**. A new window opens with an interface list. You can mark individual interfaces as trusted.

You can use the  button to insert another policy above the list entry. The configuration menu for creating a new policy opens.

You can use the  button to move the list entry. A dialog box opens, in which you can select the position to which the policy is to be moved.

### 20.1.2.1 New

Choose the **New** button to create additional parameters.

The menu **Firewall->Policies->IPv6 Filter Rules->New** consists of the following fields:

#### Fields in the Basic Parameters menu

Field	Description
<b>Source</b>	<p>Select one of the preconfigured aliases for the source of the packet.</p> <p>In the list, all WAN/LAN interfaces, interface groups (see <b>Firewall-&gt;Interfaces-&gt;IPv6 Groups</b>), addresses (see <b>Firewall-&gt;Addresses-&gt;Address List</b>) and address groups (see <b>Firewall-&gt;Addresses-&gt;Groups</b>) are available for selection for IPv6.</p>
<b>Destination</b>	<p>Select one of the preconfigured aliases for the destination of the packet.</p> <p>In the list, all WAN/LAN interfaces, interface groups (see <b>Firewall-&gt;Interfaces-&gt;IPv6 Groups</b>), addresses (see <b>Firewall-&gt;Addresses-&gt;Address List</b>) and address groups (see <b>Firewall-&gt;Addresses-&gt;Groups</b>) are available for selection for IPv6.</p>
<b>Service</b>	<p>Select one of the preconfigured services to which the packet to be filtered must be assigned.</p> <p>The extensive range of services configured ex works includes the following:</p> <ul style="list-style-type: none"> <li>• <i>ftp</i></li> <li>• <i>telnet</i></li> <li>• <i>smtp</i></li> <li>• <i>dns</i></li> <li>• <i>http</i></li> <li>• <i>nntp</i></li> </ul> <p>Additional services are created in <b>Firewall-&gt;Services-&gt;Service List</b>.</p>

Field	Description
	In addition, the service groups configured in <b>Firewall-&gt;Services-&gt;Groups</b> can be selected.
<b>Action</b>	Select the action to be applied to a filtered packet.  Possible values: <ul style="list-style-type: none"> <li>• <i>Access</i> (default value): The packets are forwarded on the basis of the entries..</li> <li>• <i>Deny</i>: The packets are rejected.</li> <li>• <i>Reject</i>: The packets are rejected. An error message is issued to the sender of the packet.</li> </ul>

### 20.1.3 Options

In this menu, you can disable or enable the IPv4 firewall and can log its activities. In addition, you can define after how many seconds of inactivity a session shall be ended.



#### Note

The IPv6 firewall is always active and cannot be disabled.

The menu **Firewall->Policies->Options** consists of the following fields:

#### Fields in the Global Firewall Options menu

Field	Description
<b>IPv4 Firewall Status</b>	Enable or disable the IPv4 firewall function.  The function is enabled with <i>Enabled</i>  The function is enabled by default.
<b>Logged Actions</b>	Select the firewall syslog level.  The messages are output together with messages from other subsystems.  Possible values: <ul style="list-style-type: none"> <li>• <i>All</i> (default value): All firewall activities are displayed.</li> <li>• <i>Deny</i>: Only reject and deny events are shown, see "Action".</li> </ul>

Field	Description
	<ul style="list-style-type: none"> <li>• <i>Accept</i>: Only accept events are shown.</li> <li>• <i>None</i>: Syslog messages are not generated.</li> </ul>
<b>IPv4 Full Filtering</b>	<p>With TCP sessions, the SIF first verifies if a session has been established completely and correctly. The filtering itself is carried out in a second step. The default setting <b>IPv4 Full Filtering</b> has been designed to meet this "standard" case.</p> <p>If - in a two-way communication - one traffic direction is sent through the router, but the counter direction takes a different route, the data traffic of this connection will be blocked because the session is interpreted as "incomplete" by the SIF. This will happen even if there is a rule that allows the same kind data traffic in a complete session.</p> <p>In order to allow the data traffic of "incomplete" sessions you have to disable <b>IPv4 Full Filtering</b>.</p>
<b>STUN Handler</b>	<p>Enable this option if you intend to allow network devices (esp. SIP clients) to use STUN in order to identify the network address translation mode and the public IP address. The firewall creates temporary rules that allow RTP data traffic for SIP phone calls.</p>
<b>Port STUN server</b>	<p>Only for <b>STUN Handler</b>= Enabled</p> <p>Enter the number of the port to be used for the connection to the STUN server.</p> <p>The default value is 3478. A 5 digit sequence is possible.</p>

#### Fields in the **Session Timer** menu.

Field	Description
<b>UDP Inactivity</b>	<p>Enter the inactivity time after which a UDP session is to be regarded as expired (in seconds).</p> <p>Possible values are 30 to 86400.</p> <p>The default value is 180.</p>
<b>TCP Inactivity</b>	<p>Enter the inactivity time after which a TCP session is to be regarded as expired (in seconds).</p> <p>Possible values are 30 to 86400.</p>

Field	Description
	The default value is <i>3600</i> .
<b>PPTP Inactivity</b>	Enter the inactivity time after which a PPTP session is to be regarded as expired (in seconds).  Possible values are <i>30</i> to <i>86400</i> .  The default value is <i>86400</i> .
<b>Other Inactivity</b>	Enter the inactivity time after which a session of another type is to be regarded as expired (in seconds).  Possible values are <i>30</i> to <i>86400</i> .  The default value is <i>30</i> .

#### Fields in the **Factory Reset Firewall**

Field	Description
<b>Factory Reset Firewall</b>	Click <b>Reset</b> to reset the firewall to factory defaults.

## 20.2 Interfaces

### 20.2.1 IPv4 Groups

A list of all configured IPv4 interface routes is displayed in the **Firewall->Interfaces->IPv4 Groups** menu.

You can group together the interfaces of your device. This makes it easier to configure firewall rules.

#### 20.2.1.1 New

Choose the **New** button to set up new IPv4 interface groups.

The menu **Firewall->Interfaces->IPv4 Groups->New** consists of the following fields:

#### Fields in the **Basic Parameters** menu.

Field	Description
<b>Description</b>	Enter the desired description of the IPv4 interface group.

Field	Description
<b>Members</b>	Select the members of the group from the available interfaces. To do this, activate the field in the <b>Selection</b> column.

## 20.2.2 IPv6 Groups

A list of all configured IPv6 interface routes is displayed in the **Firewall->Interfaces+IPv6 Groups** menu.

You can group together the IPv6 interfaces of your device. This makes it easier to configure firewall rules.

### 20.2.2.1 New

Choose the **New** button to set up new IPv6 interface groups.

The menu **Firewall->Interfaces->IPv6 Groups->New** consists of the following fields

**Fields in the Basic Parameters menu.**

Field	Description
<b>Description</b>	Enter the desired description of the IPv6 interface group.
<b>Members</b>	Select the members of the group from the available interfaces. To do this, activate the field in the <b>Selection</b> column.

## 20.3 Addresses

### 20.3.1 Address List

A list of all configured addresses is displayed in the **Firewall->Addresses->Address List** menu.

#### 20.3.1.1 New

Choose the **New** button to create additional addresses.

The menu **Firewall->Addresses->Address List->New** consists of the following fields:

**Fields in the Basic Parameters menu.**

Field	Description
<b>Description</b>	Enter the desired description of the address.
<b>IPv4</b>	Allows configuration of IPv4 address lists. The function is enabled with <i>Enabled</i> . The function is enabled by default.
<b>Address Type</b>	Only for <b>IPv4</b> = <i>Enabled</i> Select the type of address you want to specify. Possible values: <ul style="list-style-type: none"> <li>• <i>Address / Subnet</i> (default value): Enter an IP address with subnet mask.</li> <li>• <i>Address Range</i>: Enter an IP address range with a start and end address.</li> </ul>
<b>Address / Subnet</b>	Only for <b>IPv4</b> = <i>Enabled</i> and <b>Address Type</b> = <i>Address / Subnet</i> Enter the IP address of the host or a network address and the related netmask. The default value is <i>0.0.0.0</i> .
<b>IPv6</b>	Allows configuration of IPv6 address lists. The function is enabled with <i>Enabled</i> . The function is disabled by default.
<b>Address / Prefix</b>	Only for <b>IPv6</b> = <i>Enabled</i> Enter IPv6 address and the related prefix.

### 20.3.2 Groups

A list of all configured address groups is displayed in the **Firewall->Addresses->Groups** menu.

You can group together addresses. This makes it easier to configure firewall rules.



### 20.3.2.1 New

Choose the **New** button to set up additional address groups.

The menu **Firewall->Addresses->Groups->New** consists of the following fields:

#### Fields in the Basic Parameters menu.

Field	Description
<b>Description</b>	Enter the desired description of the address group.
<b>IP Version</b>	Select the IP version used.  Possible values: <ul style="list-style-type: none"> <li>• <i>IPv4</i></li> <li>• <i>IPv6</i></li> </ul> <i>IPv4</i> is selected by default.
<b>Selection</b>	Select the members of the group from the available <b>Addresses</b> . To do this, activate the Fields in the <b>Selection</b> column.

## 20.4 Services

### 20.4.1 Service List

In the **Firewall->Services->Service List** menu, a list of all available services is displayed.

#### 20.4.1.1 New

Choose the **New** button to set up additional services.

The menu **Firewall->Services->Service List->New** consists of the following fields:

#### Fields in the Basic Parameters menu.

Field	Description
<b>Description</b>	Enter an alias for the service you want to configure.
<b>Protocol</b>	Select the protocol on which the service is to be based. The

Field	Description
	<p>most important protocols are available for selection.</p>
<b>Destination Port Range</b>	<p>Only for <b>Protocol</b> = <i>TCP</i>, <i>UDP/TCP</i> or <i>UDP</i></p> <p>In the first field, enter the destination port via which the service is to run.</p> <p>If a port number range is specified, in the second field enter the last port of the port range. By default the field does not contain an entry. If a value is displayed, this means that the previously specified port number is verified. If a port range is to be checked, enter the upper limit here.</p> <p>Possible values are <i>1</i> to <i>65535</i>.</p>
<b>Source Port Range</b>	<p>Only for <b>Protocol</b> = <i>TCP</i>, <i>UDP/TCP</i> or <i>UDP</i></p> <p>In the first field, enter the source port to be checked, if applicable.</p> <p>If a port number range is specified, in the second field enter the last port of the port range. By default the field does not contain an entry. If a value is displayed, this means that the previously specified port number is verified. If a port range is to be checked, enter the upper limit here.</p> <p>Possible values are <i>1</i> to <i>65535</i>.</p>
<b>Type</b>	<p>Only for <b>Protocol</b> = <i>ICMP</i></p> <p>The <b>Type</b> field shows the class of ICMP messages, the <b>Code</b> field specifies the type of message in greater detail.</p> <p>Possible values:</p> <ul style="list-style-type: none"> <li>• <i>Any</i> (default value)</li> <li>• <i>Echo Reply</i></li> <li>• <i>Destination unreachable</i></li> <li>• <i>Source Quench</i></li> <li>• <i>Redirect</i></li> <li>• <i>Echo</i></li> <li>• <i>Time Exceeded</i></li> </ul>

Field	Description
	<ul style="list-style-type: none"> <li>• <i>Parameter Problem</i></li> <li>• <i>Timestamp</i></li> <li>• <i>Timestamp Reply</i></li> <li>• <i>Information Request</i></li> <li>• <i>Information Reply</i></li> <li>• <i>Address Mask Request</i></li> <li>• <i>Address Mask Reply</i></li> </ul>
<b>Code</b>	<p>Selection options for the ICMP codes are only available for <b>Type</b> = <i>Destination unreachable</i></p> <p>Possible values:</p> <ul style="list-style-type: none"> <li>• <i>Any (default value)</i></li> <li>• <i>Net Unreachable</i></li> <li>• <i>Host Unreachable</i></li> <li>• <i>Protocol Unreachable</i></li> <li>• <i>Port Unreachable</i></li> <li>• <i>Fragmentation Needed</i></li> <li>• <i>Communication with Destination Network is Administratively Prohibited</i></li> <li>• <i>Communication with Destination Host is Administratively Prohibited</i></li> </ul>

## 20.4.2 Groups

A list of all configured service groups is displayed in the **Firewall->Services->Groups** menu.

You can group together services. This makes it easier to configure firewall rules.

### 20.4.2.1 New

Choose the **New** button to set up additional service groups.

The menu **Firewall->Services->Groups->New** consists of the following fields:

**Fields in the Basic Parameters menu.**

Field	Description
<b>Description</b>	Enter the desired description of the service group.
<b>Members</b>	Select the members of the group from the available service aliases. To do this, activate the Fields in the <b>Selection</b> column.

## 20.5 Configuration

### 20.5.1 SIF - Configuration example

#### Requirements

- Internet connection
- Your LAN must be connected to one of ports 1, 2, 3 or 4 on the gateway.

#### Example scenario

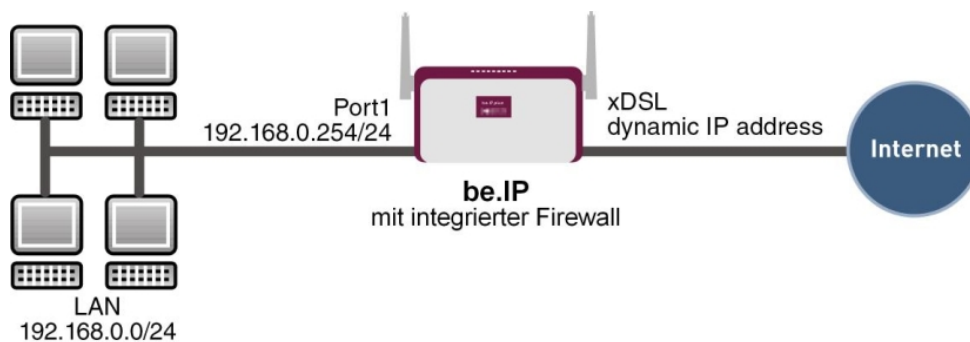

#### Configuration target

- Only certain Internet services are to be available for the staff of a company (HTTP, HTTPS, FTP, DNS).
- The gateway should operate as a DNS proxy, which means that the clients use the gateway as a DNS server.
- Only the system administrator and the director should be able to establish an HTTP and a Telnet connection to the gateway.
- The director must be able to use all services in the Internet.
- All other data traffic will be blocked.



**Important**

An incorrect configuration of the firewall can significantly disrupt the functionality of the gateway or drop the connections.

The usual principle for firewalls also applies: Everything that is not explicitly allowed is prohibited.

This means accurate planning of the filter rules and filter rule chain is necessary to ensure correct operation.

## Overview of Configuration Steps

### Aliases for IP addresses and network address

Field	Menu	Value
Description	Firewall->Addresses->Address List->New	e.g. <i>Administrator</i>
Address Type	Firewall->Addresses->Address List->New	<i>Address / Subnet</i>
Address / Subnet	Firewall->Addresses->Address List->New	e.g. <i>192.168.0.2</i> with <i>255.255.255.255</i>
Description	Firewall->Addresses->Address List->New	e.g. <i>Director</i>
Address Type	Firewall->Addresses->Address List->New	<i>Address / Subnet</i>
Address / Subnet	Firewall->Addresses->Address List->New	e.g. <i>192.168.0.3</i> with <i>255.255.255.255</i>
Description	Firewall->Addresses->Address List->New	e.g. <i>be.IP</i>
Address Type	Firewall->Addresses->Address List->New	<i>Address / Subnet</i>
Address / Subnet	Firewall->Addresses->Address List->New	e.g. <i>192.168.0.254</i> with <i>255.255.255.255</i>
Description	Firewall->Addresses->Address List->New	e.g. <i>Network Internal</i>
Address Type	Firewall->Addresses->Address List->New	<i>Address / Subnet</i>

Field	Menu	Value
Address / Subnet	Firewall->Addresses->Address List->New	e.g. <i>192.168.0.0</i> with <i>255.255.255.0</i>

### Address groups

Field	Menu	Value
Description	Gro Firewall->Addresses->ups->New	e.g. <i>be.IP</i>
IP Version	Gro Firewall->Addresses->ups->New	<i>IPv4</i>
Selection	Gro Firewall->Addresses->ups->New	e.g. <i>Administrator</i> and <i>Director</i>

### Service Sets

Field	Menu	Value
Description	Group Ne Firewall->Services->s->w	e.g. <i>Internet Ports</i>
Members	Group Ne Firewall->Services->s->w	e.g. <i>http, http (SSL) and ftp</i>
Description	Group Ne Firewall->Services->s->w	e.g. <i>Administration Ports</i>
Members	Group Ne Firewall->Services->s->w	e.g. <i>http</i> and <i>telnet</i>

### Filter rules 1: Manage Gateway (System administrator)

Field	Menu	Value
Source Location	Firewall->Policies->IPv4 Filter Rules->New	<i>be.IP</i>
Destination	Firewall->Policies->IPv4 Filter Rules->New	<i>be.IP</i>
Service	Firewall->Policies->IPv4 Filter Rules->New	<i>Administration Ports</i>

Field	Menu	Value
Action	Firewall->Policies->IPv4 Filter Rules->New	Access

#### Filter rules 2: Use gateway as DNS proxy

Field	Menu	Value
Source Location	Firewall->Policies->IPv4 Filter Rules->New	LOCAL
Destination	Firewall->Policies->IPv4 Filter Rules->New	ANY
Service	Firewall->Policies->IPv4 Filter Rules->New	dns
Action	Firewall->Policies->IPv4 Filter Rules->New	Access
Source Location	Firewall->Policies->IPv4 Filter Rules->New	Netzwerk_Intern
Destination	Firewall->Policies->IPv4 Filter Rules->New	be.IP
Service	Firewall->Policies->IPv4 Filter Rules->New	dns
Action	Firewall->Policies->IPv4 Filter Rules->New	Access

#### Filter rules 3: Deny access from outside to the Gateway

Field	Menu	Value
Source Location	Firewall->Policies->IPv4 Filter Rules->New	ANY
Destination	Firewall->Policies->IPv4 Filter Rules->New	be.IP
Service	Firewall->Policies->IPv4 Filter Rules->New	any
Action	Firewall->Policies->IPv4 Filter Rules->New	Deny

#### Filter rules 4: Allow access to all services on the Internet (Director)

Field	Menu	Value
Source Location	Firewall->Policies->IPv4 Filter Rules->New	Director
Destination	Firewall->Policies->IPv4	ANY

Field	Menu	Value
	Filter Rules->New	
Service	Firewall->Policies->IPv4 Filter Rules->New	<i>any</i>
Action	Firewall->Policies->IPv4 Filter Rules->New	<i>Access</i>

#### Filter rules 5: Allow access to the Internet (Staff)

Field	Menu	Value
Source Location	Firewall->Policies->IPv4 Filter Rules->New	<i>Network_Internal</i>
Destination	Firewall->Policies->IPv4 Filter Rules->New	<i>ANY</i>
Service	Firewall->Policies->IPv4 Filter Rules->New	<i>Internet Ports</i>
Action	Firewall->Policies->IPv4 Filter Rules->New	<i>Access</i>



## Chapter 21 Local Services

This menu offers services for the following application areas:

- Name resolution (DNS)
- Configuration via web browser (HTTPS)
- Locating of dynamic IP addresses using a DynDNS provider
- Configuration of gateway as a DHCP server (assignment of IP addresses)
- Assignment of incoming and outgoing data and voice calls to authorised users (CAPI server)
- Automation of tasks according to schedule (scheduling)
- Alive checks for hosts or interfaces, ping tests
- Realtime video/audio conferences (Messenger services, universal plug & play)
- Provision of public Internet accesses (hotspot).
- Start network devices that are switched off via an integrated network card (Wake-On-LAN)
- Data traffic of a specific interface (Trace Interface)

### 21.1 DNS

Each device in a TCP/IP network is usually located by its IP address. Because host names are often used in networks to reach different devices, it is necessary for the associated IP address to be known. This task can be performed by a DNS server, which resolves the host names into IP addresses. Alternatively, name resolution can also take place over the HOSTS file, which is available on all PCs.

Your device offers the following options for name resolution:

- DNS Proxy, for forwarding DNS requests sent to your device to a suitable DNS server. This also includes specific forwarding of defined domains (Forwarded Domains).
- DNS cache, for saving the positive and negative results of DNS requests.
- Static entries (static hosts), to manually define or prevent assignments of IP addresses to names.
- DNS monitoring (statistics), to provide an overview of DNS requests on your device.

#### Name server

Under **Local Services->DNS->DNS Servers->New** you enter the IP addresses of name servers that are queried if your device cannot answer requests itself or by forwarding entries. Global name servers and name servers that are attached to an interface can both be entered.

Your device can also receive the global name servers dynamically via PPP or DHCP and transfer them dynamically if necessary.

## Strategy for name resolution on your device

A DNS request is handled by your device as follows:

- (1) If possible, the request is answered directly from the static or dynamic cache with IP address or negative response.
- (2) Otherwise, if a suitable forwarding entry exists, the relevant DNS server is asked, depending on the configuration of the Internet or dialin connections, if necessary by setting up a WAN connection at extra cost. If the DNS server can resolve the name, the information is forwarded and a dynamic entry created in the cache.
- (3) Otherwise, if name servers have been entered, taking into account the priority configured and if the relevant interface status is "up", the primary DNS server is queried and then the secondary DNS server. If one of the DNS servers can resolve the name, the information is forwarded and a dynamic entry created in the cache.
- (4) Otherwise, if a suitable Internet or dialin connection is selected as the standard interface, the relevant DNS server is asked, depending on the configuration of the Internet or dialin connections, if necessary by setting up a WAN connection at extra cost. If one of the DNS servers can resolve the name, the information is forwarded and a dynamic entry created in the cache.
- (5) Otherwise, if overwriting the addresses of the global name servers is allowed in the **WAN->Internet + Dialup** menu (**Interface Mode** = *Dynamic*), a connection is set up – if necessary at extra cost – to the first Internet or dialin connection configured to enable DNS server addresses to be requested from DNS servers (**DNS Negotiation** = *Enabled*), if this has not been already attempted. When the name servers have been negotiated successfully, these name servers are then available for more queries.
- (6) Otherwise the initial request is answered with a server error.

If one of the DNS servers answers with `non-existent domain`, the initial request is immediately answered accordingly and a corresponding negative entry is made in the DNS cache of your device.

### 21.1.1 Global Settings

The menu **Local Services->DNS->Global Settings** consists of the following fields:

**Fields in the Basic Parameters menu**

Field	Description
<b>Domain Name</b>	Enter the standard domain name of your device.
<b>WINS Server</b>	Enter the IP address of the first and, if necessary, alternative global Windows Internet Name Server (=WINS) or NetBIOS Name Server (=NBNS).
<b>Primary</b>	
<b>Secondary</b>	

The menu **Advanced Settings** consists of the following fields:

**Fields in the Advanced Settings menu**

Field	Description
<b>Positive Cache</b>	<p>Select whether the positive dynamic cache is to be activated, i.e. successfully resolved names and IP addresses are to be stored in the cache.</p> <p>The function is activated by selecting <i>Enabled</i>.</p> <p>The function is enabled by default.</p>
<b>Negative Cache</b>	<p>Select whether the negative dynamic cache is to be activated, i.e. whether queried names for which a DNS server has sent a negative response are stored as negative entries in the cache.</p> <p>The function is activated by selecting <i>Enabled</i>.</p> <p>The function is enabled by default.</p>
<b>Cache Size</b>	<p>Enter the maximum total number of static and dynamic entries.</p> <p>Once this value is reached, the dynamic entry not requested for the longest period of time is deleted when a new entry is added. <b>Cache Size</b> is reduced by the user, dynamic entries are deleted if necessary. Statistical entries are not deleted. <b>Cache Size</b> cannot be set to lower than the current number of static entries.</p> <p>Possible values: <i>0.. 1000</i>.</p> <p>The default value is <i>100</i>.</p>
<b>Maximum TTL for Positive Cache Entries</b>	Enter the value to which the TTL is to be set for a positive dynamic DNS entry in the cache if its TTL is <i>0</i> or its TTL exceeds

Field	Description
	<p>the value for <b>Maximum TTL for Positive Cache Entries</b> .</p> <p>The default value is <i>86400</i>.</p>
<b>Maximum TTL for Negative Cache Entries</b>	<p>Enter the value set to which the TTL is to be set in the case of a negative dynamic entry in the cache.</p> <p>The default value is <i>86400</i>.</p>
<b>Fallback interface to get DNS server</b>	<p>Select the interface to which a connection is set up for name server negotiation if other name resolution attempts were not successful.</p> <p>The default value is <i>Automatic</i>, i.e. a one-time connection is set up to the first suitable connection partner configured in the system.</p>

#### Fields in the IP address to use for DNS/WINS server assignment menu

Field	Description
<b>As DHCP Server</b>	<p>Select which name server addresses are sent to the DHCP client if your device is used as DHCP server.</p> <p>Possible values:</p> <ul style="list-style-type: none"> <li>• <i>None</i>: No name server address is sent.</li> <li>• <i>Own IP Address</i> (default value): The address of your device is transferred as the name server address.</li> <li>• <i>DNS Setting</i>: The addresses of the global name servers entered on your device are sent.</li> </ul>
<b>As IPCP Server</b>	<p>Select which name server addresses are to be transmitted by your device in the event of dynamic server name negotiation if your device is used as the IPCP server for PPP connections.</p> <p>Possible values:</p> <ul style="list-style-type: none"> <li>• <i>None</i>: No name server address is sent.</li> <li>• <i>Own IP Address</i>: The address of your device is transferred as the name server address.</li> <li>• <i>DNS Setting</i> (default value): The addresses of the global name servers entered on your device are sent.</li> </ul>

## 21.1.2 DNS Servers

A list of all configured DNS servers is displayed in the **Local Services->DNS->DNS Servers** menu.

### 21.1.2.1 Edit or New

Choose the  icon to edit existing entries. Select the **New** button to set up additional DNS servers.

Here you can configure both global DNS servers and DNS servers that are to be assigned to a particular interface.

Configuring a DNS server for a particular interface can be useful, for example, if accounts with different providers have been set up via different interfaces and load balancing is being used.

The **Local Services->DNS->DNS Servers->New** menu consists of the following fields:

#### Fields in the Basic Parameters menu.

Field	Description
<b>Admin Status</b>	Select whether the DNS server should be enabled.  The function is activated by selecting <i>Enabled</i> .  The function is enabled by default.
<b>Description</b>	Enter a description for DNS server.
<b>Priority</b>	Assign a priority to the DNS server.  You can assign more than one pair of DNS servers ( <b>Primary DNS Server</b> and <b>Secondary DNS Server</b> ) to an interface (i. e. for example, to an Ethernet port or a PPPoE WAN partner). The pair with the highest priority is used if the interface is "up".  Possible values from 0 (highest priority) to 9 (lowest priority).  The default value is 5.
<b>Interface Mode</b>	Select whether the IP addresses of name servers for resolving the names of Internet addresses are to be obtained automatically or whether up to two fixed DNS server addresses are to be

Field	Description
	<p>entered, depending on the priority.</p> <p>Possible values:</p> <ul style="list-style-type: none"> <li>• <i>Static</i></li> <li>• <i>Dynamic</i> (default value)</li> </ul>
<b>Interface</b>	<p>Select the interface to which the DNS server pair is to be assigned.</p> <p>For <b>Interface Mode</b> = <i>Dynamic</i></p> <p>A global DNS server is created with the setting <i>None</i>.</p> <p>For <b>Interface Mode</b> = <i>Static</i></p> <p>A DNS server is configured for all interfaces with the <i>Any</i> setting.</p>
<b>IP Version</b>	<p>Select the IP version used.</p> <p>Possible values:</p> <ul style="list-style-type: none"> <li>• <i>IPv4</i></li> <li>• <i>IPv6</i></li> </ul> <p><i>IPv4</i> is selected by default.</p>
<b>Primary IPv4 DNS Server</b>	<p>Only if <b>Interface Mode</b> = <i>Static</i></p> <p>Enter the IPv4 address of the first name server for Internet address name resolution.</p>
<b>Secondary IPv4 DNS Server</b>	<p>Only if <b>Interface Mode</b> = <i>Static</i></p> <p>Optionally, enter the IPv4 address of an alternative name server.</p>
<b>Primary IPv6 DNS Server</b>	<p>Only if <b>Interface Mode</b> = <i>Static</i></p> <p>Enter the IPv6 address of the first name server for Internet address name resolution.</p>
<b>Secondary IPv6 DNS Server</b>	<p>Only if <b>Interface Mode</b> = <i>Static</i></p>

Field	Description
	Optionally, enter the IPv6 address of an alternative name server.

## 21.1.3 Static Hosts

A list of all configured static hosts is displayed in the **Local Services->DNS->Static Hosts** menu.

### 21.1.3.1 New

Choose the **New** button to set up new static hosts.

The menu **Local Services->DNS->Static Hosts->New** consists of the following fields:

#### Fields in the **Basic Parameters** menu.

Field	Description
<b>DNS Hostname</b>	<p>Enter the host name to which the <b>IP Address</b> defined in this menu is to be assigned if a positive response is received to a DNS request. If a negative response is received to a DNS request, no address is specified.</p> <p>The entry can also start with the wildcard *, e.g. *.bintec-elmeg.com.</p> <p>If a name is entered without a dot, this is completed with <b>OK</b> "&lt;Name.&gt;" after confirmation.</p> <p>Entries with spaces are not allowed.</p>
<b>Response</b>	<p>In this entry, select the type of response to DNS requests.</p> <p>Possible values:</p> <ul style="list-style-type: none"> <li>• <i>Negative</i>: A DNS request for <b>DNS Hostname</b> gets a negative response.</li> <li>• <i>Positive</i> (default value): A DNS request for <b>DNS Hostname</b> is answered with the related <b>IP Address</b>.</li> <li>• <i>None</i>: A DNS request is ignored; no answer is given.</li> </ul>
<b>IPv4 Address</b>	Only if <b>Response</b> = <i>Positive</i>

Field	Description
	Enter the IPv4 address assigned to <b>DNS Hostname</b> .
<b>IPv6 Address</b>	Only if <b>Response</b> = <i>Positive</i> Enter the IPv6 address assigned to <b>DNS Hostname</b> .

## 21.1.4 Domain Forwarding

In the **Local Services->DNS->Domain Forwarding** menu, a list of all configured forwardings for defined domains is displayed.

### 21.1.4.1 New

Choose the **New** button to set up additional forwardings.

The menu **Local Services->DNS->Domain Forwarding->New** consists of the following fields:

#### Fields in the Forwarding Parameters menu.

Field	Description
<b>Forward</b>	Select whether requests for a host or domain are to be forwarded.  Possible values: <ul style="list-style-type: none"> <li>• <i>Host</i> (default value)</li> <li>• <i>Domain</i></li> </ul>
<b>Host</b>	Only for <b>Forward</b> = <i>Host</i>  Enter the name of the host for which requests are to be forwarded.  If you enter a name without a ".", the entry is supplemented with the name supplied by the value specified in <b>Local Services-&gt;DNS-&gt;Global Settings</b> for <b>Domain Name</b> as soon as you confirm with <b>OK</b> .
<b>Domain</b>	Only for <b>Forward</b> = <i>Domain</i>  Enter the name of the domain for which requests are to be for-



Field	Description
	<p>warded.</p> <p>The entry can start with the wildcard "*", e.g. "*.bintec-elmeg.com".</p> <p>If you enter a name without a leading wildcard "*" a leading wildcard "*" is supplemented as soon as you confirm with <b>OK</b>.</p>
<b>Forward to</b>	<p>Select if matching DNS requests are to be forwarded to the DNS server of an <b>Interface</b> or to a manually specified <b>DNS Server</b>.</p> <p>Possible values:</p> <ul style="list-style-type: none"> <li>• <i>Interface</i> (default value): Requests are forwarded to the DNS server assigned to either an automatically selected or to a user-selected interface.</li> <li>• <i>DNS Server</i>: Requests are forwarded to the specified <b>DNS Server</b>.</li> </ul>
<b>Interface</b>	<p>Only for <b>Forward to</b> = <i>Interface</i></p> <p>Select the interface that has the DNS server assigned which is to receive the DNS requests.</p>
<b>Primary DNS Server (IPv4/IPv6)</b>	<p>Only for <b>Forward to</b> = <i>DNS Server</i></p> <p>Enter the IPv4/IPv6 address of the primary DNS server.</p>
<b>Secondary DNS Server (IPv4/IPv6)</b>	<p>Only for <b>Forward to</b> = <i>DNS Server</i></p> <p>Enter the IPv4/IPv6 address of the secondary DNS server.</p>

### 21.1.5 Dynamic Hosts

In the menu **Local Services->DNS->Dynamic Hosts**, you can find relevant information on dynamic DNS entries.

### 21.1.6 Cache

In the **Local Services->DNS->Cache** menu, a list of all available cache entries is displayed.

You can select individual entries using the checkbox in the corresponding line, or select them all using the **Select all** button.

A dynamic entry can be converted to a static entry by marking the entry and confirming with **Make static**. This corresponding entry disappears from the list and is displayed in the list in the **Static Hosts** menu. The TTL is transferred.

## 21.1.7 Statistics

In the **Local Services->DNS->Statistics** menu, the following statistical values are displayed:

### Fields in the DNS Statistics menu.

Field	Description
<b>Received DNS Packets</b>	Shows the number of received DNS packets addressed direct to your device, including the response packets for forwarded requests.
<b>Invalid DNS Packets</b>	Shows the number of invalid DNS packets received and addressed direct to your device.
<b>DNS Requests</b>	Shows the number of valid DNS requests received and addressed direct to your device.
<b>Cache Hits</b>	Shows the number of requests that were answered with static or dynamic entries from the cache.
<b>Forwarded Requests</b>	Shows the number of requests forwarded to other name servers.
<b>Cache Hitrate (%)</b>	Indicates the number of <b>Cache Hits</b> pro DNS request in percentage.
<b>Successfully Answered Queries</b>	Shows the number of successfully answered requests (positive and negative).
<b>Server Failures</b>	Shows the number of requests that were not answered by any name server (either positively or negatively).

## 21.2 HTTPS

You can operate the user interface of your device from any PC with an up-to-date Web browser via an HTTPS connection.

HTTPS (HyperText Transfer Protocol Secure) is the procedure used to establish an en-

encrypted and authenticated connection by SSL between the browser used for configuration and the device.

### 21.2.1 HTTPS Server

In the **Local Services->HTTPS->HTTPS Server** menu, configure the parameters of the backed up configuration connection via HTTPS.

The **Local Services->HTTPS->HTTPS Server** menu consists of the following fields:

**Fields in the HTTPS Parameters menu.**

Field	Description
<b>HTTPS TCP Port</b>	<p>Enter the port via which the HTTPS connection is to be established.</p> <p>Possible values are 0 to 65535.</p> <p>The default value is 443.</p>
<b>Local Certificate</b>	<p>Select a certificate that you want to use for the HTTPS connection.</p> <p>Possible values:</p> <ul style="list-style-type: none"> <li>• <i>Internal</i> (default value): Select this option if you want to use the certificate built into the device.</li> <li>• <i>&lt;Certificate name&gt;</i>: Under <b>System Management-&gt;Certificates-&gt;Certificate List</b> select entered certificate.</li> </ul>

## 21.3 DynDNS Client

The use of dynamic IP addresses has the disadvantage that a host in the network can no longer be found once its IP address has changed. DynDNS ensures that your device can still be reached after a change to the IP address.

The following configuration steps are necessary:

- Registration of a host name at a DynDNS provider
- Configuration of your device

### Registration

The registration of a host name means that you define an individual user name for the DynDNS service, e.g. *dyn\_client*. The service providers offer various domain names for this, so that a unique host name results for your device, e.g. *dyn\_client.provider.com*. The DynDNS provider relieves you of the task of answering all DNS requests concerning the host *dyn\_client.provider.com* with the dynamic IP address of your device.

To ensure that the provider always knows the current IP address of your device, your device contacts the provider when setting up a new connection and propagates its present IP address.

## 21.3.1 DynDNS Update

In the **Local Services->DynDNS Client->DynDNS Update** menu, a list of all configured DynDNS registrations for updating is displayed

### 21.3.1.1 New

Choose the **New** button to set up further DynDNS registrations to be updated.

The menu **Local Services->DynDNS Client->DynDNS Update->New** consists of the following fields:

#### Fields in the Basic Parameters menu.

Field	Description
<b>Host Name</b>	Enter the complete host name as registered with the DynDNS provider.
<b>Interface</b>	Select the WAN interface whose IP address is to be propagated over the DynDNS service (e.g. the interface of the Internet Service Provider).
<b>User Name</b>	Enter the user name as registered with the DynDNS provider.
<b>Password</b>	Enter the password as registered with the DynDNS provider.
<b>Provider</b>	Select the DynDNS provider with which the above data is registered.  A choice of DynDNS providers is already available in the unconfigured state and their protocols are supported.

Field	Description
	<p>Other DynDNS providers can be configured in the <b>Local Services-&gt;DynDNS Client-&gt;DynDNS Provider</b> menu.</p> <p>The default value is <i>DynDNS</i>.</p>
<b>Enable update</b>	<p>Select whether the DynDNS entry configured here is to be activated.</p> <p>The function is activated by selecting <i>Enabled</i>.</p> <p>The function is disabled by default.</p>

The menu **Advanced Settings** consists of the following fields:

#### Fields in the **Advanced Settings** menu.

Field	Description
<b>Mail Exchanger (MX)</b>	<p>Enter the full host name of a mail server to which e-mails are to be forwarded if the host currently configured is not to receive mail.</p> <p>Ask your provider about this forwarding service and make sure e-mails can be received from the host entered as MX.</p>
<b>Wildcard</b>	<p>Select whether forwarding of all subdomains of the <b>Host Name</b> is to be enabled for the current IP address of the <b>Interface</b> (advanced name resolution).</p> <p>The function is activated by selecting <i>Enabled</i>.</p> <p>The function is disabled by default.</p>

## 21.3.2 DynDNS Provider

A list of all configured DynDNS providers is displayed in the **Local Services->DynDNS Client->DynDNS Provider** menu.

### 21.3.2.1 New

Choose the **New** button to set up new DynDNS providers.

The menu **Local Services->DynDNS Client->DynDNS Provider->New** consists of the following fields:

**Fields in the Basic Parameters menu.**

Field	Description
<b>Provider Name</b>	Enter a name for this entry.
<b>Server</b>	Enter the host name or IP address of the server on which the provider's DynDNS service runs.
<b>Update Path</b>	Enter the path on the provider's server that contains the script for managing the IP address of your device.  Ask your provider for the path to be used.
<b>Port</b>	Enter the port at which your device is to reach your provider's server.  Ask your provider for the relevant port.  The default value is <i>80</i> .
<b>Protocol</b>	Select one of the protocols implemented.  Possible values: <ul style="list-style-type: none"> <li>• <i>DynDNS</i> (default value)</li> <li>• <i>Static DynDNS</i></li> <li>• <i>ODS</i></li> <li>• <i>HN</i></li> <li>• <i>DYNS</i></li> <li>• <i>GnuDIP-HTML</i></li> <li>• <i>GnuDIP-TCP</i></li> <li>• <i>Custom DynDNS</i></li> <li>• <i>DnsExit</i></li> </ul>
<b>Update Interval</b>	Enter the minimum time (in seconds) that your device must wait before it is allowed to propagate its current IP address to the DynDNS provider again.  The default value is <i>300</i> seconds.

## 21.4 DHCP Server

You can configure your device as a DHCP (Dynamic Host Configuration Protocol) server.

Your device and each PC in your LAN requires its own IP address. One option for allocating IP addresses in your LAN is the Dynamic Host Configuration Protocol (DHCP). If you configure your device as a DHCP server, the device automatically assigns IP addresses to requesting PCs in the LAN from a predefined IP address pool.

If a client requires an IP address for the first time, it sends a DHCP request (with its MAC address) to the available DHCP server as a network broadcast.\* The client then receives its IP address from bintec elmeg (as part of a brief exchange).

You therefore do not need to allocate fixed IP addresses to PCs, which reduces the amount of configuration work in your network. To do this, you set up a pool of IP addresses, from which your device assigns IP addresses to hosts in the LAN for a defined period of time. A DHCP server also transfers the addresses of the domain name server entered statically or by PPP negotiation (DNS), NetBIOS name server (WINS) and default gateway.

For specific instructions how to use your device as a DHCP server, DHCP client or DHCP relay agent, see the end of the chapter [DHCP - Configuration example](#) on page 500.

### 21.4.1 IP Pool Configuration

The **Local Services->DHCP Server->IP Pool Configuration** menu displays a list of all the configured IP pools. This list is global and also displays pools configured in other menus.

#### 21.4.1.1 Edit or New

Choose the **New** button to set up new IP address pools. Choose the  icon to edit existing entries.

#### Fields in the menu Basic Parameters

Field	Description
<b>IP Pool Name</b>	Enter any description to uniquely identify the IP pool.
<b>IP Address Range</b>	Enter the first (first field) and last (second field) IP address of the IP address pool.
<b>DNS Server</b>	<b>Primary:</b> Enter the IP address of the DNS server that is to be

Field	Description
	used, preferably, by clients who draw an address from this pool.  <b>Secondary:</b> Optionally, enter the IP address of an alternative DNS server.

## 21.4.2 DHCP Configuration

To activate your device as a DHCP server, you must first define IP address pools from which the IP addresses are distributed to the requesting clients.

A list of all configured DHCP pools is displayed in the **Local Services->DHCP Server->DHCP Configuration** menu.

In the list, for each entry, you have the possibility under **Status** of enabling or disabling the configured DHCP pools.



### Note

In the ex works state the DHCP pool is preconfigured with the IP addresses 192.168.0.10 to 192.168.0.49 and is used if there is no other DHCP server available in the network.

### 21.4.2.1 Edit or New

Choose the **New** button to set up new DHCP pools. Choose the  icon to edit existing entries.

The **Local Services->DHCP Server->DHCP Configuration->New** menu consists of the following fields:

#### Fields in the menu Basic Parameters

Field	Description
<b>Interface</b>	Select the interface over which the addresses defined in <b>IP Pool Name</b> are to be assigned to DHCP clients.  When a DHCP request is received over this <b>Interface</b> , one of the addresses from the address pool is assigned.
<b>IP Pool Name</b>	Select an IP pool name configured in the <b>Local Services-&gt;DHCP Server-&gt;IP Pool Configuration</b> menu.



Field	Description
<b>Pool Usage</b>	<p>Select if the DHCP pool is to be used for requests from clients in a network directly connected to an Ethernet interface, or if it is to be used for DHCP requests from a remote network that are sent to your device via a DHCP relay station.</p> <p>In the second case, it is possible to use an IP address pool for the remote network.</p> <p>Possible values:</p> <ul style="list-style-type: none"> <li>• <i>Local</i> (default value): The DHCP pool is only used for DHCP requests from a network directly connected to an Ethernet interface.</li> <li>• <i>Relay</i>: The DHCP pool is only used for DHCP requests forwarded from remote networks.</li> <li>• <i>Local/Relay</i>: The DHCP pool can be used for both kinds of requests.</li> </ul>

The menu **Advanced Settings** consists of the following fields:

#### Fields in the menu **Advanced Settings**

Field	Description
<b>Gateway</b>	<p>Select which IP address is to be transferred to the DHCP client as gateway.</p> <p>Possible values:</p> <ul style="list-style-type: none"> <li>• <i>Use router as gateway</i> (default value): Here, the IP address defined for the <b>Interface</b> is transferred.</li> <li>• <i>No gateway</i>: No IP address is sent.</li> <li>• <i>Specify</i>: Enter the corresponding IP address.</li> </ul>
<b>Lease Time</b>	<p>Enter the length of time (in minutes) for which an address from the pool is to be assigned to a host.</p> <p>After the <b>Lease Time</b> expires, the address can be reassigned by the server.</p> <p>The default value is <i>120</i>.</p>
<b>DHCP Options</b>	Specify which additional data is forwarded to the DHCP client.

Field	Description
	<p>Possible values for <b>Option</b>:</p> <ul style="list-style-type: none"> <li>• <i>Time Server</i> (default value): Enter the IP address of the time server to be sent to the client.</li> <li>• <i>DNS Server</i>: Enter the IP address of the DNS server to be sent to the client.</li> <li>• <i>DNS Domain Name</i>: Enter the DNS domain to be sent to the client.</li> <li>• <i>WINS/NBNS Server</i>: Enter the IP address of the WINS/NBNS server to be sent to the client.</li> <li>• <i>WINS/NBT Node Type</i>: Select the type of the WINS/NBT node to be sent to the client.</li> <li>• <i>TFTP Server</i>: Enter the IP address of the TFTP server to be sent to the client.</li> <li>• <i>CAPWAP Controller</i>: Enter the IP address of the CAPWAP controller to be sent to the client.</li> <li>• <i>URL (provisioning server)</i>: This option enables you to send a client any URL.</li> </ul> <p>Use this option to send querying <b>IP1x0</b> telephones the URL of the provisioning server if the telephones are to be provisioned automatically. The URL then needs to take the form <i>http://&lt;IP address of the provisioning server&gt;/eg_prov</i>.</p> <ul style="list-style-type: none"> <li>• <i>Vendor Group</i> (Vendor Specific Information): This enables you to send the client any manufacturer-specific information in any text string.</li> <li>• <i>Vendor String</i>: With this option, the configuration parameters (e. g. PIN and the SIM card's access point name (APN)) can be transferable.</li> </ul> <p>Several entries are possible. Add additional entries with the <b>Add</b> button.</p>

### Vendor Group

In the **Local Services->DHCP Server ->DHCP Configuration->Advanced Settings** menu you can edit an entry in the **DHCP Options** field, if **Option = Vendor Group** is selected.

Choose the  icon to edit an existing entry. In the popup menu, you configure manufacturer-specific settings in the DHCP server for specific telephones, for example.

#### Fields in the Basic Parameters menu

Field	Description
<b>Select vendor</b>	<p>Here, you can select for which manufacturer specific values shall be transmitted for the DHCP server.</p> <p>Possible values:</p> <ul style="list-style-type: none"> <li>• <i>Siemens</i> (default value)</li> <li>• <i>Other</i></li> </ul>
<b>Provisioning Server</b>	<p>Only für <b>Select vendor</b> = <i>Siemens</i></p> <p>Enter which manufacturer value shall be transmitted.</p> <p>For the setting <b>Select vendor</b> = <i>Siemens</i>, the default value <i>sdlp</i> is displayed.</p> <p>You can complete the IP address of the desired server.</p>
<b>Vendor Description</b>	<p>Only für <b>Select vendor</b> = <i>Other</i></p> <p>Type in the name of the manufacturer for which you want to transfer specific DHCP server settings.</p>
<b>Custom DHCP Options</b>	<p>Only für <b>Select vendor</b> = <i>Other</i></p> <p>Use <b>Add</b> to add more entries.</p> <p>You can add custom DHCP options.</p>

#### Vendor String

Go to the menu **Local Services->DHCP Server->DHCP Configuration->Advanced Settings**, proceed as follows in order to specify the respective parameter:

Click the **Add** button in the **DHCP Options** field and choose **Option** = *Vendor String*.  
Click the  button to edit the entry.

#### Fields in the Basic Parameters menu

Field	Description
<b>Select vendor</b>	Here, you can select for which manufacturer specific values

Field	Description
	shall be transmitted for the DHCP server.  Possible values: <ul style="list-style-type: none"> <li>• <i>Other</i> (default value)</li> <li>• <i>-bintec-</i></li> </ul>
<b>APN</b>	Only für <b>Select vendor</b> = <i>-bintec-</i>  Enter the Access Point Namen (APN) of the SIM card.
<b>PIN</b>	Only für <b>Select vendor</b> = <i>-bintec-</i>  Enter the PIN of the SIM card.
<b>Vendor Description</b>	Only für <b>Select vendor</b> = <i>Other</i>  Type in the name of the manufacturer for which you want to transfer specific DHCP server settings.
<b>Vendor Option String</b>	Only für <b>Select vendor</b> = <i>Other</i>  Enter the manufacturer specific configuration parameters.

### 21.4.3 IP/MAC Binding

The **Local Services->DHCP Server->IP/MAC Binding** menu displays a list of all clients that received an IP address from your device via DHCP.

You can allocate an IP address from a defined IP address pool to specific MAC addresses. You can do this by selecting the **Static Binding** option in the list to convert a list entry as a fixed binding, or you manually create a fixed IP/MAC binding by configuring this in the **New** sub-menu.



#### Note

You can only create new static IP/MAC bindings if IP address ranges were configured in **Local Services->DHCP Server->DHCP Pool**, and in the **Local Services->DHCP Server->IP Pool Configuration** menu is assigned a valid IP Pool.

### 21.4.3.1 New

Choose the **New** button to set up new IP/MAC bindings.

The menu **Local Services->DHCP Server->IP/MAC Binding->New** consists of the following fields:

#### Fields in the **Basic Parameters** menu.

Field	Description
<b>Description</b>	Enter the name of the host to which the <b>MAC Address</b> the <b>IP Address</b> is to be bound.  A character string of up to 256 characters is possible.
<b>IP Address</b>	Enter the IP address to be assigned to the MAC address specified in <b>MAC Address</b> is to be assigned.
<b>MAC Address</b>	Enter the MAC address to which the IP address specified in <b>IP Address</b> is to be assigned.

### 21.4.4 DHCP Relay Settings

If your device for the local network does not distribute any IP addresses to the clients by DHCP, it can still forward the DHCP requests on behalf of the local network to a remote DHCP server. The DHCP server then assigns the your device an IP address from its pool, which in turn sends this to the client in the local network.

The menu **Local Services->DHCP Server->DHCP Relay Settings** consists of the following fields:

#### Fields in the **Basic Parameters** menu.

Field	Description
<b>Primary DHCP Server</b>	Enter the IP address of a server to which BootP or DHCP requests are to be forwarded.  The default value is <code>0.0.0.0</code> .
<b>Secondary DHCP Server</b>	Enter the IP address of an alternative BootP or DHCP server.  The default value is <code>0.0.0.0</code> .

## 21.4.5 DHCP - Configuration example

### Requirements

- An optional DHCP server

### Example scenaria

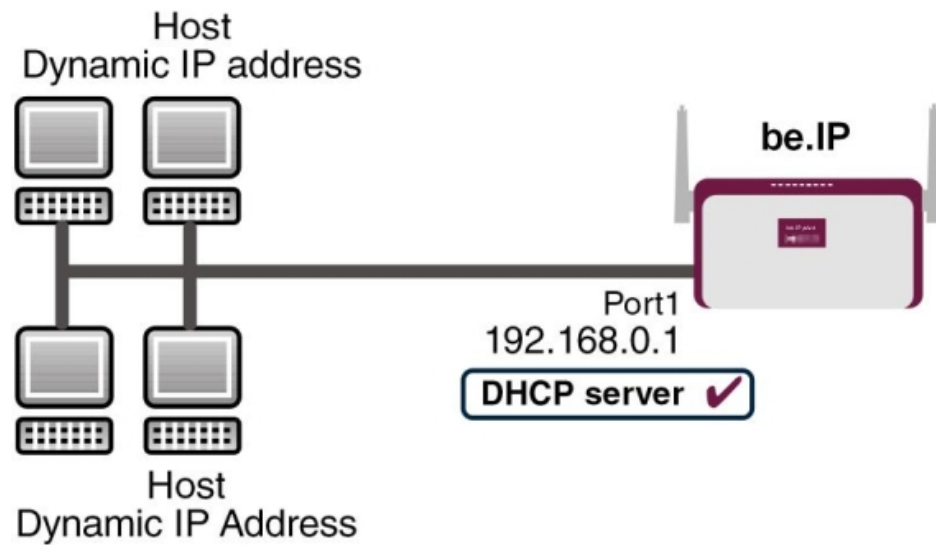

Example scenario as DHCP Server

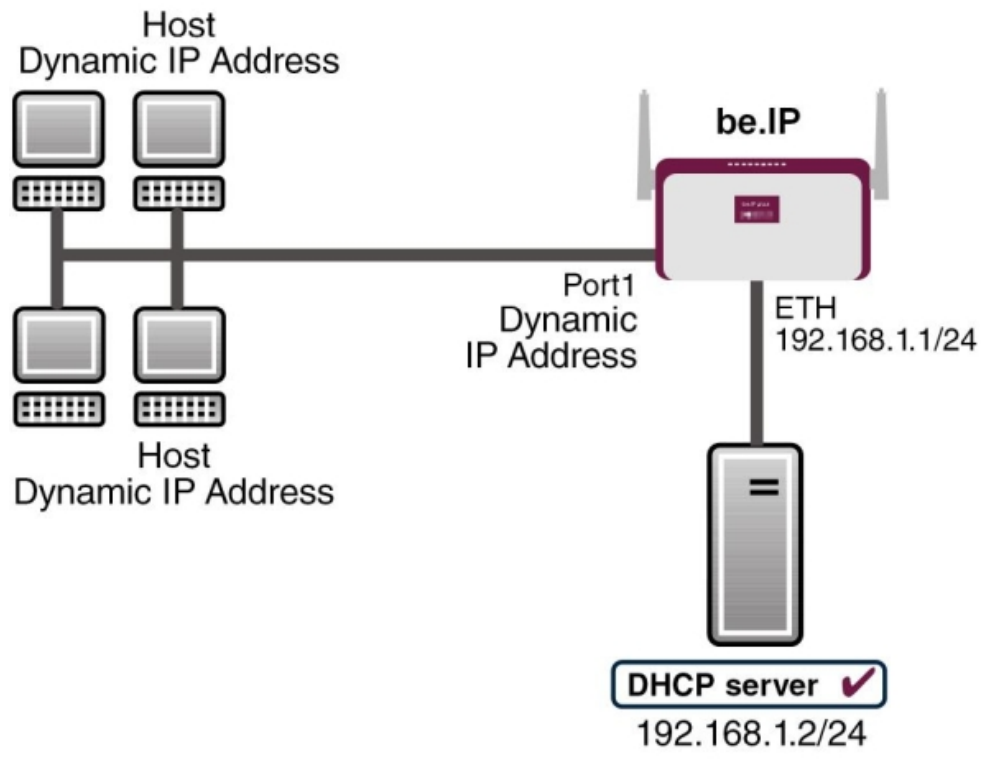

Example scenario as DHCP Client

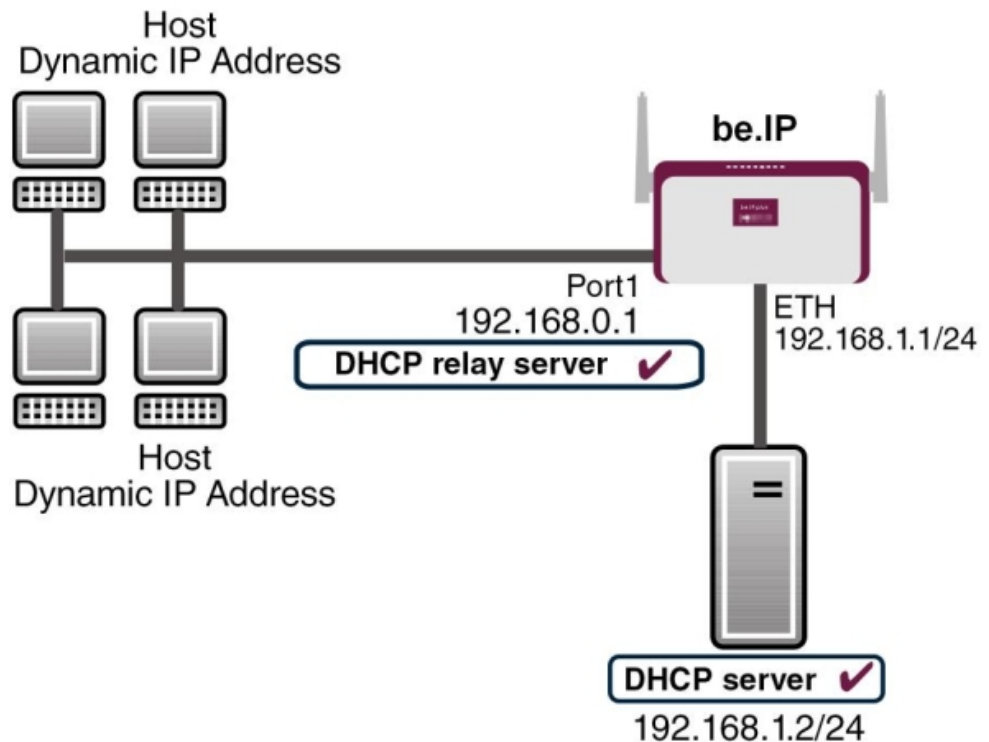

Example scenario as DHCP Relay Server

### Configuration target

You can use your device as a DHCP server, DHCP client or DHCP relay agent.

### Overview of Configuration Steps



#### DHCP Server

Field	Menu	Value
IP Pool Name	Local Services->DHCP Server->IP Pool Configuration->New	e.g. <i>IP-Pool-1</i>
IP Address Range	Local Services->DHCP Server->IP Pool Configuration->New	e.g. <i>192.168.0.2</i> and <i>192.168.0.10</i>
Interface	Local Services->DHCP Server->DHCP Configuration->New	e.g. <i>en1-0</i>
IP Pool Name	Local Services->DHCP Server->DHCP Configuration->New	<i>IP-Pool-1</i>
Pool Usage	Local Services->DHCP Server->DHCP Configuration->New	<i>Local</i>



Field	Menu	Value
Gateway	Local Services->DHCP Server->DHCP Configuration->New->Advanced Settings	Use Router as Gateway
Lease Time	Local Services->DHCP Server->DHCP Configuration->New->Advanced Settings	e.g. 120
IP address to use for DNS/WINS server assignment	Local Services->DNS->Global Settings->Advanced Settings	e.g. Own IP address

#### DHCP Client

Field	Menu	Value
Address Mode	LAN->IP Configuration->Interfaces-><en1-4>-> 	DHCP
DHCP MAC Address (optional)	LAN->IP Configuration->Interfaces-><en1-4> ->  ->Advanced Settings	MAC address for a specific DHCP server

#### DHCP Relay Server

Field	Menu	Value
Primary DHCP Server	Local Services->DHCP Server->DHCP Relay Settings	e.g. 192.168.1.2
Secondary DHCP Server (optional)	Local Services->DHCP Server->DHCP Relay Settings	if one exists

## 21.5 DHCPv6 Server

You can operate your device as a DHCPv6 server. The DHCPv6 server can either assign IP addresses as well as DHCPv6 options or DHCPv6 options only without any addresses. These parameters are collected in a so called "Option Set". An option set can be linked to an interface (see **Local Services->DHCPv6 Server->DHCPv6 Server->New**), or it can be configured globally (see **Local Services->DHCPv6 Server->DHCPv6 Global Options->New**). DHCP options can, e.g., contain information about DNS or time servers.



### Note

An IPv6 address pool is created by assigning an IPv6 Link Prefix (a subnet with a length of /64) to a DHCPv6 option set. The definition of a separate set of IP addresses like, e.g. fc00:1:2:3::1..fc00:1:2:3::100, is - in contrast with IPv4 - not specified for IPv6.

The following requirements must be met for the configuration of an IPV6 address pool:

- (a) IPv6 has to be activated for the respective interface.
- (b) An IPv6 Link Prefix (subnet) with a length of /64 has to be configured for the respective interface. An IPv6 link prefix can be defined in either of two ways:
  - The IPv6 Link Prefix is derived from a General IPv6 Prefix (a prefix with a length of, e.g., /56 or /48). In this case, the General IPv6 Prefix has to be configured in the menu **Networking->IPv6 General Prefixes->General Prefix Configuration**.
  - The IPv6 Link Prefix with a length of /64 is manually configured for the respective interface and is not derived from a General IPv6 Prefix.
- (c) The **DHCP Server** option has to be enabled for the interface.

Moreover, the following settings are recommended:

- The options **Preferred Lifetime** and **Valid Lifetime** should be set to values higher than the value configured for the option **Router Lifetime**.

With a **Router Lifetime** of 600 seconds a **Preferred Lifetime** of, e.g., 900 seconds and a **Valid Lifetime** of 1800 seconds are reasonable settings.

- The option **DHCP Mode** should be enabled.

In order to make the settings mentioned above, go to the menu **LAN->IP Configuration->Interfaces**. Choose the intended interface with the  icon. Activate IPv6 and set the **IPv6 Mode** to *Router (Transmit Router Advertisement)*. In the field **IPv6-Adressen**, click **Hinzufügen** and configure the Link Prefix. Confirm your configuration with **Accept**. The configuration of the recommended settings is then carried out in the following menus:

- **Router Lifetime:** **LAN->IP Configuration->Interfaces->New->Advanced Settings->Advanced IPv6 Settings**
- **Preferred Lifetime** and **Valid Lifetime:** **LAN->IP Configuration->Interfaces->New->Basic IPv6 Parameters->Add->Advanced**

## 21.5.1 DHCPv6 Server

Here you can create interface-related address pools and define DHCP options inside of an DHCP Option Set.

### 21.5.1.1 Edit or New

Use the **New** button in order to create an Option Set. Use the  icon in order to edit an existing entry.

The menu consists of the following fields:

#### Fields in the menu Basic Parameters

Field	Description
<b>Name</b>	Enter a name for the Option Set.
<b>Interface</b>	<p>Select the IPv6 interface the Option Set is assigned to.</p> <p>You can choose from interfaces with the following configuration:</p> <ul style="list-style-type: none"> <li>• IPv6 is enabled.</li> <li>• The option <b>DHCP Server</b> is enabled.</li> </ul> <p>In the ex works state, IPv6 is disabled for all interfaces. If the intended interface is not offered for selection, configure it according to the requirements detailed in the introduction of this section. Configuration is done on the menu <b>LAN-&gt;IP Configuration-&gt;Interfaces</b>.</p>
<b>Address assignment</b>	<p>The definition of an IPv6 address pools is carried out by assigning an IPv6 Link Prefix (subnet with a length of /64) to a DHCPv6 Option Set. The IPv6 address pool always comprises the complete 64 Bit address space of the selected IPv6 Link Prefix. Address assignment is random.</p> <p>Use <b>Add</b> to assign one or more IPv6 Link Prefixes to the IPv6 Option Set.</p>



#### Note

Note that only such IPv6 Link Prefixes are available for selection that are assigned to the selected interface.

### Fields in the menu **Server Options**

Field	Description
<b>DNS domains search list</b>	Use <b>Add</b> to create a list of domain names which is queried by the client during name resolution (DHCPv6 Option 24 "Domain Search List"). Domain names will be transmitted to the clients in the order defined by the list.

The menu **Advanced Settings** consists of the following fields:

### Fields in the menu **Advanced Server Options**

Field	Description
<b>DNS Server</b>	<p>Here you can configure the DNS servers that are propagated by DHCPv6. (DHCPv6 Option 23 "DNS Recursive Name Server").</p> <p>Per default, the global DNS server of the system are propagated. (Global DNS servers are configured by the field <b>DNS Propagation</b> in the menu <b>LAN-&gt;IP Configuration-&gt;Interfaces-&gt;  -&gt;Advanced Settings</b> if <b>IPv6 = Enabled</b>.)</p> <p>You can also manually specify DNS servers and have them propagated to the clients. To do this disable the option <b>Use RA or Global Fallback DNS Server</b> and create the desired DNS server entries using <b>Add</b>.</p>
<b>SNTP Server</b>	Here you can configure the time servers to be propagated by DHCPv6 (DHCPv6 Option 31 "Simple Network Time Protocol Server"). Use <b>Add</b> to create the desired time server entries.

## 21.5.2 DHCPv6 Global Options

In this menu, you can configure those DHCPv6 options which are globally valid for the DHCPv6 server. An option that has been configured here will be propagated if there is no more specific definition is available (e.g., no interface- or vendor-ID-specific definition).

The menu consist of the following fields:

### Fields in the menu **Basic Parameters**

Field	Description
<b>DNS domains search list</b>	Use <b>Add</b> to create a list of domain names which is queried by the client during name resolution (DHCPv6 Option 24 "Domain

Field	Description
	Search List"). Domain names will be transmitted to the clients in the order defined by the list. The domain name (e.g. dev.bintec.de.) must end with a dot (.).

The menu **Advanced Settings** consist of the following fields:

#### Fields in the menu **Server preference**

Field	Description
<b>Server preference</b>	<p>The DHCPv6 advertisements sent by the DHCPv6 server to the clients may contain the DHCPv6 option 7 "Preference".</p> <p>Possible values are <code>0 . . . 255</code>.</p> <p>In a network with multiple DHCPv6 servers this option controls which server takes the highest priority. If a client receives DHCPv6 advertisements with different priorities from different servers, it will usually accept the parameters from the highest priority server. The client can, however, also accept DHCPv6 advertisements with a lower priority if the set of parameters in the advertisement provides more of the options requested by the client.</p> <p>A value of <code>0</code> means "not specified" (lowest priority), <code>255</code> denotes the highest priority.</p>

#### Fields in the menu **Advanced Server Fallback Options**

Field	Description
<b>DNS Server</b>	<p>Here you can configure the DNS servers that are propagated by DHCPv6. (DHCPv6 Option 23 "DNS Recursive Name Server").</p> <p>Per default, the global DNS server of the system are propagated. (Global DNS servers are configured by the field <b>DNS Propagation</b> in the menu <b>LAN-&gt;IP Configuration-&gt;Interfaces-&gt;</b>  <b>-&gt;Advanced Settings</b> if <b>IPv6 = Enabled</b>.)</p> <p>You can also manually specify DNS servers and have them propagated to the clients. To do this disable the option <b>Use RA or Global Fallback DNS Server</b> and create the desired DNS server entries using <b>Add</b>.</p>
<b>SNTP Server</b>	<p>Here you can configure the time servers to be propagated by DHCPv6 (DHCPv6 Option 31 "Simple Network Time Protocol</p>

Field	Description
	Server"). Use <b>Add</b> to create the desired time server entries.

### 21.5.3 Stateful Clients

Here you see an entry for each Stateful Client that has contacted the server and has been assigned an IPv6 address.

### 21.5.4 Stateful Clients Configuration

During a stateful configuration of IPv6 clients not only the DHCP options, but also the IPv6 prefix is transmitted to the client.

#### 21.5.4.1 Edit or New

Use **New** to create entries for Stateful Clients. Normally, you do not have to create any entries. Use  in order to edit existing entries. You should check each automatically created entry once to verify the settings and adjust them if required.

The menu consists of the following fields.

#### Fields in the menu Basic Parameters

Field	Description
<b>DUID</b>	<p>Clients use the <b>DUID field</b> (DHCP Unique Identifier) in order to identify themselves and request an IP address from the DHCPv6 server.</p> <p>If you create an entry using <b>New</b> you can specify the <b>DUID</b> as a 16 - 20 digit HEX number. You can enter them using a "-" (minus) as separator (Windows style), or you can enter them in a single block (Linux style).</p>
<b>Accept Client FQDN</b>	If <b>Accept Client FQDN</b> is enabled, the client is entered into the cache of the Domain Name Server with the parameter FQDN (Fully Qualified Domain Name).
<b>Administrative FQDNs</b>	With <b>Add</b> , you can specify an FQDN (Fully Qualified Domain Name) - even for automatically created entries.
<b>Static Interface Identifier</b>	The field <b>Static Interface Identifier</b> is the host portion of the

Field	Description
	IPv6 address, i.e., the last 64 Bit of the IP address. This prefix must start with ::.

## 21.6 CAPI Server

You can use the CAPI Server function to assign user names and passwords to users of the CAPI applications on your device. This makes sure that only authorised users can receive incoming calls and make outgoing calls via CAPI.

The CAPI service allows connection of incoming and outgoing data and voice calls to communications applications on hosts in the LAN that access the Remote CAPI interface of your device. This enables, for example, hosts connected to your device to receive and send faxes.



### Note

All incoming calls to the CAPI are offered to all registered and "eavesdropping" CAPI applications in the LAN.

In the ex works state, a user with the user name *default* and no password is entered for the CAPI subsystem.

Once you've created your intended users with password, you should delete the *default* user without password.

### 21.6.1 User

A list of all configured CAPI users is displayed in the **Local Services->CAPI Server->User** menu.

#### 21.6.1.1 New

Choose the **New** button to set up new CAPI users.

The menu **Local Services->CAPI Server->User->New** consists of the following fields:

#### Fields in the Basic Parameters menu.

Field	Description
<b>User Name</b>	Enter the user name for which access to the CAPI service is to

Field	Description
	be allowed or denied.
<b>Password</b>	Enter the password which the user <b>User Name</b> shall use for identification to gain access to the CAPI service.
<b>Access</b>	Select whether access to the CAPI service is to be permitted or denied for the user.  The function is activated by selecting <i>Enabled</i> .  The function is enabled by default.

## 21.6.2 Options

The menu **Local Services->CAPI Server->Options** consists of the following fields:

### Fields in the **Basic Parameters** menu.

Field	Description
<b>Enable server</b>	Select whether your device is to be enabled as a CAPI server.  The function is activated by selecting <i>Enabled</i> .  The function is enabled by default.
<b>Faxheader</b>	Only for devices the <b>RTxxx2</b> series.  Select whether the fax header should be printed at the top of outgoing faxes.  The function is activated by selecting <i>Enabled</i> .  The function is disabled by default.
<b>CAPI Server TCP Port</b>	The field can only be edited if <b>Enable server</b> is enabled.  Enter the TCP port number for remote CAPI connections.  The default value is <i>2662</i> .



## 21.7 Scheduling

Your device has an event scheduler which enables certain standard actions (activation or deactivation of interfaces, for example) to be carried out. In addition, every existing MIB variable can be configured with any value.

You configure the desired **Actions** and define the triggers controlling the date and other conditions of the **Actions**. A trigger may be a single event or a sequence of events collected in an **Event List**. For a single event, create an **Event List** containing only one element.

It is possible to trigger operations on a time-controlled basis. What's more, the status or accessibility of interfaces, or their data traffic can lead to performance of the configured operations, as also the validity of licences. Here again, it is possible to configure every MIB variable with any value as initiator.

Activate the **Schedule Interval** option under **Options** to put the event scheduler into operation. The system uses this time interval to check if at least one event has occurred. This triggers the configured action.

Specific instructions for configuring Time-controlled Tasks (Scheduling), see the end of the chapter [Configuration example - Time-controlled Tasks \(Scheduling\)](#) on page 528.



### Caution

The configuration of actions that are not available as defaults requires extensive knowledge of the method of operation of bintec elmeg gateways. An incorrect configuration can cause considerable disruption during operation. If applicable, save the original configuration on your PC.



### Note

To run the event scheduler, the date configured on your device must be 1.1.2000 or later.

### 21.7.1 Trigger

All configured event lists are displayed in the **Local Services->Scheduling->Trigger** menu. Each event list contains at least one event intended to trigger a configured action.

### 21.7.1.1 New

Choose the **New** button to create additional event lists.

The menu **Local Services->Scheduling->Trigger->New** consists of the following fields:

#### Fields in the Basic Parameters menu

Field	Description
<b>Event List</b>	<p>You can create a new event list with <i>New</i> (default value). You give this list a name with <b>Description</b>. You use the remaining parameters to create the first event in the list.</p> <p>If you want to add to an existing event list, select the event list you want and add at least one more event to it.</p> <p>You can use event lists to create complex conditions for initiating an action. The events are processed in the same order in which they are created in the list.</p>
<b>Description</b>	<p>Only for <b>Event List</b> <i>New</i></p> <p>Enter your chosen designation for the <b>Event List</b>.</p>
<b>Event Type</b>	<p>Select the type of initiator.</p> <p>Possible values:</p> <ul style="list-style-type: none"> <li>• <i>Time</i> (default value): The operations configured and assigned in <b>Actions</b> are initiated at specific points in time.</li> <li>• <i>MIB/SNMP</i>: The operations configured and assigned in <b>Actions</b> are initiated when the defined MIB variables assumes the assigned values.</li> <li>• <i>Interface Status</i>: Operations configured and assigned in <b>Actions</b> are initiated, when the defined interfaces take on a specified status.</li> <li>• <i>Interface Traffic</i>: Operations configured and assigned in <b>Actions</b> are initiated when the data traffic on the specified interfaces falls below or exceeds the defined value.</li> <li>• <i>Ping Test</i>: Operations configured and assigned in <b>Actions</b> are initiated when the specified IP address is / is not accessible.</li> <li>• <i>Certificate Lifetime</i>: Operations configured and as-</li> </ul>

Field	Description
	<p>signed in <b>Actions</b> are initiated when the defined period of validity is reached.</p> <ul style="list-style-type: none"> <li>• <i>Function Button</i>: The option <i>Function Button</i> determines that pushing the function button on the device can serve as a trigger for any configured action. Pushing the button for approx. one second (but less than three seconds) sets the button status to <i>Active</i>, pushing it for more than three seconds sets it to <i>Inactive</i>. Actions depending on the state of the button are then carried out after the next cyclical query determined by the <b>Schedule Interval</b>. In this way, e.g., a WLAN interface can be activated when the button is pushed for a second. Pushing the button for more than three seconds deactivates the interface again.</li> </ul>
<b>Monitored Variable</b>	<p>Only for <b>Event Type</b> <i>MIB/SNMP</i></p> <p>Select the MIB variable whose defined value is to be configured as initiator. First, select the <b>System</b> in which the MIB variable is saved, then the <b>MIB Table</b> and finally the <b>MIB Variable</b> itself. Only the MIB tables and MIB variables present in the respective area are displayed.</p>
<b>Compare Condition</b>	<p>Only for <b>Event Type</b> <i>MIB/SNMP</i></p> <p>Select whether the MIB variable <i>Greater</i> (default value), <i>Equal</i>, <i>Less</i>, <i>Not Equal</i> must have the value given in <i>Compare Value</i> or must lie within <i>Range</i> to initiate the operation.</p>
<b>Compare Value</b>	<p>Only for <b>Event Type</b> <i>MIB/SNMP</i></p> <p>Enter the value of the MIB variable.</p>
<b>Index Variables</b>	<p>Only for <b>Event Type</b> <i>MIB/SNMP</i></p> <p>If required, select MIB variables to uniquely identify a specific data set in a <b>MIB Table</b>, e.g. <i>ConnIfIndex</i>. The combination of <b>Index Variable</b> (normally an index variable labelled by a *) and <b>Index Value</b> creates the unique identification of a specific table entry.</p> <p>Create additional <b>Index Variables</b> with <b>Add</b>.</p>
<b>Monitored Interface</b>	<p>Only for <b>Event Type</b> <i>Interface Status</i> and <i>Interface</i></p>

Field	Description
	<p><i>Traffic</i></p> <p>Select the interface whose defined status or data traffic shall initiate an event.</p>
<b>Interface Status</b>	<p>Only for <b>Event Type</b> <i>Interface Status</i></p> <p>Select the status that the interface must have in order to initiate the intended operation.</p> <p>Possible values:</p> <ul style="list-style-type: none"> <li>• <i>Up</i> (default value): The function is enabled.</li> <li>• <i>Down</i>: The interface is disabled.</li> </ul>
<b>Traffic Direction</b>	<p>Only for <b>Event Type</b> <i>Interface Traffic</i></p> <p>Select the direction of the data traffic whose values should be monitored as initiating an operation.</p> <p>Possible values:</p> <ul style="list-style-type: none"> <li>• <i>RX</i> (default value): Incoming data traffic is monitored.</li> <li>• <i>TX</i>: Outgoing data traffic is monitored.</li> </ul>
<b>Interface Traffic Condition</b>	<p>Only for <b>Event Type</b> <i>Interface Traffic</i></p> <p>Select whether the value for data traffic must be <i>Greater</i> (default value) or <i>Less</i> the value specified in <i>Transferred Traffic</i> in order to initiate the operation.</p>
<b>Transferred Traffic</b>	<p>Only for <b>Event Type</b> <i>Interface Traffic</i></p> <p>Enter the desired value in <b>kBytes</b> for the data traffic to serve as comparison.</p> <p>The default value is <i>0</i>.</p>
<b>Destination IP Address</b>	<p>Only for <b>Event Type</b> <i>Ping Test</i></p> <p>Enter the IP address whose accessibility is to be checked.</p>
<b>Source IP Address</b>	<p>Only for <b>Event Type</b> <i>Ping Test</i></p> <p>Enter an IP address to be used as sender address for the ping test.</p>

Field	Description
	<p>Possible values:</p> <ul style="list-style-type: none"> <li>• <i>Automatic</i> (default value): The IP address of the interface over which the ping is sent is automatically entered as sender address.</li> <li>• <i>Specific</i>: Enter the desired IP address in the input field.</li> </ul>
<b>Status</b>	<p>Only for <b>Event Type</b> <i>Ping Test</i></p> <p>Select whether <b>Destination IP Address</b> <i>Reacheable</i> must be (default value) or <i>Unreacheable</i> in order to initiate the operation.</p>
<b>Interval</b>	<p>Only for <b>Event Type</b> <i>Ping Test</i></p> <p>Enter the time in <b>Seconds</b> after which a ping must be resent.</p> <p>The default value is 60 seconds.</p>
<b>Trials</b>	<p>Only for <b>Event Type</b> <i>Ping Test</i></p> <p>Enter the number of ping tests to be performed until <b>Destination IP Address</b> as <i>Unreacheable</i> applies.</p> <p>The default value is 3.</p>
<b>Monitored Certificate</b>	<p>Only for <b>Event Type</b> <i>Certificate Lifetime</i></p> <p>Select the certificate whose validity should be checked.</p>
<b>Remaining Validity</b>	<p>Only for <b>Event Type</b> <i>Certificate Lifetime</i></p> <p>Indicate the remaining validity of the certificate in percentage.</p>
<b>Function Button Status</b>	<p>Only for <b>Event Type</b> <i>Function Button</i>.</p> <p>When creating the trigger the dropdown selection <b>Function Button Status</b> allows you to choose which status of the function button activates or deactivates the trigger. If you set the status to <i>On</i>, the trigger becomes active if the status of the function button is <i>Active</i>, and inactive, if the state of the function button is <i>Inactive</i>. If your set it to <i>Off</i>, the trigger becomes active if the state of the function button is <i>Inactive</i>, and inactive if the state of the function button is <i>Active</i>. The current</p>

Field	Description
	state is checked cyclically at the configured schedule interval.

#### Fields in the **Select time interval** menu

Field	Description
<b>Time Condition</b>	<p>Only for <b>Event Type</b> = <i>Time</i></p> <p>First select the type of time entry in <b>Condition Type</b>.</p> <p>Possible values:</p> <ul style="list-style-type: none"> <li>• <i>Weekday</i>: Select a weekday in <b>Condition Settings</b>.</li> <li>• <i>Periods</i> (default value): In <b>Condition Settings</b>, select a particular period.</li> <li>• <i>Day of Month</i>: Select a specific day of the month in <b>Condition Settings</b>.</li> </ul> <p>Possible values for <b>Condition Settings</b> in <b>Condition Type</b> = <i>Weekday</i>:</p> <p><i>Monday</i> (default value) ... <i>Sunday</i>.</p> <p>Possible values for <b>Condition Settings</b> in <b>Condition Type</b> = <i>Periods</i>:</p> <ul style="list-style-type: none"> <li>• <i>Daily</i>: The initiator becomes active daily (default value).</li> <li>• <i>Monday - Friday</i>: The initiator becomes active daily from Monday to Friday.</li> <li>• <i>Monday - Saturday</i>: The initiator becomes active daily from Monday to Saturday.</li> <li>• <i>Saturday - Sunday</i>: The initiator becomes active on Saturdays and Sundays.</li> </ul> <p>Possible values for <b>Condition Settings</b> in <b>Condition Type</b> = <i>Day of Month</i>:</p> <p><i>1 ... 31</i>.</p>
<b>Start Time</b>	Enter the time from which the initiator is to be activated. Activation is carried on the next scheduling interval. the default value of this interval is 55 seconds.
<b>Stop Time</b>	Enter the time from which the initiator is to be deactivated. De-

Field	Description
	activation is carried on the next scheduling interval. If you do not enter a <b>Stop Time</b> or set a <b>Stop Time = Start Time</b> , the initiation is activated, and deactivated after 10 seconds.

## 21.7.2 Actions

In the **Local Services->Scheduling->Actions** menu is displayed a list of all operations to be initiated by events or event chains configured in **Local Services->Scheduling->Trigger**.

### 21.7.2.1 New

Choose the **New** button to configure additional operations.

The menu **Local Services->Scheduling->Actions->New** consists of the following fields:

#### Fields in the menu **Basic Parameters**

Field	Description
<b>Description</b>	Enter your chosen designation for the action.
<b>Command Type</b>	<p>Select the desired action.</p> <p>Possible values:</p> <ul style="list-style-type: none"> <li>• <i>Reboot</i> (default value): Your device is rebooted.</li> <li>• <i>MIB/SNMP</i>: The desired value is entered for a MIB variable.</li> <li>• <i>Interface Status</i>: The status of an interface is modified.</li> <li>• <i>Wlan Status</i>: Only for devices with a wireless LAN. The status of a WLAN-SSID is modified.</li> <li>• <i>Software Update</i>: A software update is initiated.</li> <li>• <i>Configuration Management</i>: A configuration file is loaded onto your device or backed up by your device.</li> <li>• <i>Ping Test</i>: Accessibility of an IP address is checked.</li> <li>• <i>Certificate Management</i>: A certificate is to be renewed, deleted or entered.</li> <li>• <i>5 GHz WLAN Bandscan</i>: Only for devices with a wireless LAN. A scan of the 5 GHz frequency band is performed.</li> <li>• <i>5.8 GHz WLAN Bandscan</i>: Only for devices with a wireless</li> </ul>

Field	Description
	<p>LAN. A scan of the 5.8 GHz frequency range is performed.</p> <ul style="list-style-type: none"> <li>• <i>WLC: New Neighbor Scan</i>: Only for devices with a WLAN controller. A Neighbor Scan is initiated by the WLAN network controlled by the WLAN controller.</li> <li>• <i>WLC: VSS State</i>: Only for devices with a WLAN controller. The status of a wireless network is modified.</li> <li>• <i>WLAN: Operation Mode</i>: The operating mode of a WLAN radio module is modified.</li> </ul>
<b>Event List</b>	Select the event list you want which has been created in <b>Local Services-&gt;Scheduling-&gt;Trigger</b> .
<b>Event List Condition</b>	<p>For the selected chains of events, select how many of the configured events must occur for the operation to be initiated.</p> <p>Possible values:</p> <ul style="list-style-type: none"> <li>• <i>All</i> (default value): The operation is initiated if all events occur.</li> <li>• <i>One</i>: The operation is initiated if a single event occurs.</li> <li>• <i>None</i>: The operation is triggered if no event occurs.</li> <li>• <i>One not</i>: The operation is triggered if one of the events does not occur.</li> </ul>
<b>Reboot device after</b>	<p>Only if <b>Command Type</b> = <i>Reboot</i></p> <p>Enter the timespan in seconds that must elapse after occurrence of the event until the device is restarted.</p> <p>The default value is 60 seconds.</p>
<b>MIB/SNMP Variable to add/edit</b>	<p>Only if <b>Command Type</b> = <i>MIB/SNMP</i></p> <p>Select the MIB table in which the MIB variable whose value shall be changed is saved. First, select the <b>System</b>, then the <b>MIB Table</b>. Only the MIB tables present in the respective area are displayed.</p>
<b>Command Mode</b>	<p>Only if <b>Command Type</b> = <i>MIB/SNMP</i></p> <p>Select how the MIB entry is to be manipulated.</p> <p>Possible settings:</p>



Field	Description
	<ul style="list-style-type: none"> <li>• <i>Change existing entry</i> (default value): An existing entry shall be modified.</li> <li>• <i>Create new MIB entry</i>: A new entry shall be created.</li> </ul>
<b>Index Variables</b>	<p>Only if <b>Command Type</b> = <i>MIB/SNMP</i></p> <p>Where required, select MIB variables to uniquely identify a specific data set in <b>MIB Table</b>, e.g. <i>ConnIfIndex</i>. The unique identification of a particular table entry is derived from the combination of <b>Index Variable</b> (usually an index variable which is flagged with *) and <b>Index Value</b>.</p> <p>Use <b>Index Variables</b> to create more entries with <b>Add</b>.</p>
<b>Trigger Status</b>	<p>Only if <b>Command Type</b> = <i>MIB/SNMP</i></p> <p>Select what status the event must have in order to modify the MIB variable as defined.</p> <p>Possible values:</p> <ul style="list-style-type: none"> <li>• <i>Active</i> (default value): The value of the MIB variable is modified if the initiator is active.</li> <li>• <i>Inactive</i>: The value of the MIB variable is modified if the initiator is inactive.</li> <li>• <i>Both</i>: The value of the MIB variable is differentially modified if the initiator status changes.</li> </ul>
<b>MIB Variables</b>	<p>Only if <b>Command Type</b> = <i>MIB/SNMP</i></p> <p>Select the MIB variable whose value is to be configured as dependent upon initiator status.</p> <p>If the initiator is active (<b>Trigger Status</b> <i>Active</i>), the MIB variable is described with the value entered in <b>Active Value</b>.</p> <p>If the initiator is inactive (<b>Trigger Status</b> <i>Inactive</i>), the MIB variable is described with the value entered in <b>Inactive Value</b>.</p> <p>If the MIB variable is to be modified, depending on whether the initiator is active or inactive (<b>Trigger Status</b> <i>Both</i>), it is described with an active initiator with the value entered in <b>Active Value</b> and with an inactive initiator with the value in <b>Inactive Value</b>.</p>

Field	Description
	Use <b>Add</b> to create more entries.
<b>Interface</b>	<p>Only if <b>Command Type</b> = <i>Interface Status</i></p> <p>Select the interface whose status should be changed.</p>
<b>Set interface status</b>	<p>Only if <b>Command Type</b> = <i>Interface Status</i></p> <p>Select the status to be set for the interface.</p> <p>Possible values:</p> <ul style="list-style-type: none"> <li>• <i>Up</i> (default value)</li> <li>• <i>Down</i></li> <li>• <i>Reset</i></li> </ul>
<b>Local WLAN SSID</b>	<p>Only if <b>Command Type</b> = <i>Wlan Status</i></p> <p>Select the desired wireless network whose status shall be changed.</p>
<b>Set status</b>	<p>Only if <b>Command Type</b> = <i>Wlan Status</i> or <i>WLC: VSS State</i></p> <p>Select the status for the wireless network.</p> <p>Possible values:</p> <ul style="list-style-type: none"> <li>• <i>Activate</i> (default value)</li> <li>• <i>Deactivate</i></li> </ul>
<b>Source Location</b>	<p>Only if <b>Command Type</b> = <i>Software Update</i></p> <p>Select the source for the software update.</p> <p>Possible values:</p> <ul style="list-style-type: none"> <li>• <i>Current Software from Update Server</i> (default value): The latest software will be downloaded from the update server.</li> <li>• <i>HTTP Server</i>: The latest software will be downloaded from an HTTP server that you define in <i>Server URL</i>.</li> <li>• <i>HTTPS Server</i>: The latest software will be downloaded from an HTTPS server that you define in <i>Server URL</i>.</li> </ul>

Field	Description
	<ul style="list-style-type: none"> <li>• <i>TFTP Server</i>: The latest software will be downloaded from an TFTP server that you define in <i>Server URL</i>.</li> </ul>
<b>Server URL</b>	<p>Where <b>Command Type</b> = <i>Software Update</i> if <b>Source Location</b> not <i>Current Software from Update Server</i></p> <p>Enter the URL of the server from which the desired software version is to be retrieved.</p> <p>Where <b>Command Type</b> = <i>Configuration Management</i> with <b>Action</b> = <i>Import configuration</i> or <i>Export configuration</i></p> <p>Enter the URL of the server from which a configuration file is to be retrieved, or on which the configuration file is to be backed up.</p>
<b>File Name</b>	<p>For <b>Command Type</b> = <i>Software Update</i></p> <p>Enter the file name of the software version.</p> <p>Where <b>Command Type</b> = <i>Certificate Management</i> with <b>Action</b> = <i>Import certificate</i></p> <p>Enter the file name of the certificate file.</p>
<b>Action</b>	<p>For <b>Command Type</b> = <i>Configuration Management</i></p> <p>Select which operation is to be performed on a configuration file.</p> <p>Possible values:</p> <ul style="list-style-type: none"> <li>• <i>Import configuration</i> (default value)</li> <li>• <i>Export configuration</i></li> <li>• <i>Rename configuration</i></li> <li>• <i>Delete configuration</i></li> <li>• <i>Copy configuration</i></li> </ul> <p>For <b>Command Type</b> = <i>Certificate Management</i></p> <p>Select which operation you wish to perform on a certificate file.</p> <p>Possible values:</p>

Field	Description
	<ul style="list-style-type: none"> <li>• <i>Import certificate</i> (default value)</li> <li>• <i>Delete certificate</i></li> <li>• <i>SCEP</i></li> </ul>
<b>Protocol</b>	<p>Only for <b>Command Type</b> = <i>Certificate Management</i> and <i>Configuration Management</i> if <b>Action</b> = <i>Import configuration</i></p> <p>Select the protocol for the data transfer.</p> <p>Possible values:</p> <ul style="list-style-type: none"> <li>• <i>HTTP</i> (default value)</li> <li>• <i>HTTPS</i></li> <li>• <i>TFTP</i></li> </ul>
<b>CSV File Format</b>	<p>Only where <b>Command Type</b> = <i>Configuration Management</i> and <b>Action</b> = <i>Import configuration</i> or <i>Export configuration</i></p> <p>Select whether the file is to be sent in the CSV format.</p> <p>The CSV format can easily be read and modified. In addition, you can view the corresponding file clearly using Microsoft Excel for example.</p> <p>The function is enabled by default.</p>
<b>Remote File Name</b>	<p>Only if <b>Command Type</b> = <i>Configuration Management</i></p> <p>For <b>Action</b> = <i>Import configuration</i></p> <p>Enter the name of the file under which it is saved on the server from which it is to be retrieved.</p> <p>For <b>Action</b> = <i>Export configuration</i></p> <p>Enter the file name under which it should be saved on the server.</p>
<b>Local File Name</b>	<p>Only where <b>Command Type</b> = <i>Configuration Management</i> and <b>Action</b> = <i>Import configuration</i>, <i>Rename configuration</i> or <i>Copy configuration</i></p>

Field	Description
	At import, renaming or copying enter a name for the configuration file under which to save it locally on the device.
<b>File Name in Flash</b>	<p>Where <b>Command Type</b> = <i>Configuration Management</i> and <b>Action</b> = <i>Export configuration</i></p> <p>Select the file to be exported.</p> <p>Where <b>Command Type</b> = <i>Configuration Management</i> and <b>Action</b> = <i>Rename configuration</i></p> <p>Select the file to be renamed.</p> <p>Where <b>Command Type</b> = <i>Configuration Management</i> and <b>Action</b> = <i>Delete configuration</i></p> <p>Select the file to be deleted.</p> <p>Where <b>Command Type</b> = <i>Configuration Management</i> and <b>Action</b> = <i>Copy configuration</i></p> <p>Select the file to be copied.</p>
<b>Configuration contains certificates/keys</b>	<p>Only where <b>Command Type</b> = <i>Configuration Management</i> and <b>Action</b> = <i>Import configuration</i> or <i>Export configuration</i></p> <p>Select whether the certificates and keys contained in the configuration are to be imported or exported.</p> <p>The function is disabled by default.</p>
<b>Encrypt configuration</b>	<p>Only where <b>Command Type</b> = <i>Configuration Management</i> and <b>Action</b> = <i>Import configuration</i> or <i>Export configuration</i></p> <p>Define whether the data of the selected <b>Action</b> are to be encrypted..</p> <p>The function is disabled by default.</p>
<b>Reboot after execution</b>	<p>Only if <b>Command Type</b> = <i>Configuration Management</i></p> <p>Select whether your device should restart after the intended <b>Action</b>.</p>

Field	Description
	The function is disabled by default.
<b>Version Check</b>	<p>Only where <b>Command Type</b> = <i>Configuration Management</i> and <b>Action</b> = <i>Import configuration</i></p> <p>Select whether, when importing a configuration file, to check on the server for the presence of a more current version of the already loaded configuration. If not, the file import is interrupted.</p> <p>The function is disabled by default.</p>
<b>Destination IP Address</b>	<p>Only if <b>Command Type</b> = <i>Ping Test</i></p> <p>Enter the IP address whose accessibility is to be checked.</p>
<b>Source IP Address</b>	<p>Only if <b>Command Type</b> = <i>Ping Test</i></p> <p>Enter an IP address to be used as sender address for the ping test.</p> <p>Possible values:</p> <ul style="list-style-type: none"> <li>• <i>Automatic</i> (default value): The IP address of the interface over which the ping is sent is automatically entered as sender address.</li> <li>• <i>Specific</i>: Enter the desired IP address in the input field.</li> </ul>
<b>Interval</b>	<p>Only if <b>Command Type</b> = <i>Ping Test</i></p> <p>Enter the time in <b>Seconds</b> after which a ping must be resent.</p> <p>The default value is 1 second.</p>
<b>Count</b>	<p>Only if <b>Command Type</b> = <i>Ping Test</i></p> <p>Enter the number of ping tests to be performed until <b>Destination IP Address</b> is considered unreachable.</p> <p>The default value is 3.</p>
<b>Server Address</b>	<p>Only where <b>Command Type</b> = <i>Certificate Management</i> and <b>Action</b> = <i>Import certificate</i></p> <p>Enter the URL of the server from which a certificate file is to be retrieved.</p>

Field	Description
<b>Local Certificate Description</b>	<p>Where <b>Command Type</b> = <i>Certificate Management</i> and <b>Action</b> = <i>Import certificate</i></p> <p>Enter a description for the certificate under which to save it on the device.</p> <p>Where <b>Command Type</b> = <i>Certificate Management</i> and <b>Action</b> = <i>Delete certificate</i></p> <p>Select the certificate to be deleted.</p>
<b>Password for protected Certificate</b>	<p>Only where <b>Command Type</b> = <i>Certificate Management</i> and <b>Action</b> = <i>Import certificate</i></p> <p>Select whether to use a secure certificate requiring a password and enter it into the entry field.</p> <p>The function is disabled by default.</p>
<b>Overwrite similar certificate</b>	<p>Only where <b>Command Type</b> = <i>Certificate Management</i> and <b>Action</b> = <i>Import certificate</i></p> <p>Select whether to overwrite a certificate already present on the your device with the new one.</p> <p>The function is disabled by default.</p>
<b>Write certificate in configuration</b>	<p>Only where <b>Command Type</b> = <i>Certificate Management</i> and <b>Action</b> = <i>Import certificate</i></p> <p>Select whether to integrate the certificate in a configuration file; and if so, select the desired configuration file.</p> <p>The function is disabled by default.</p>
<b>Certificate Request Description</b>	<p>Only where <b>Command Type</b> = <i>Certificate Management</i> and <b>Action</b> = <i>SCEP</i></p> <p>Enter a description under which the SCEP certificate on your device is to be saved.</p>
<b>URL SCEP Server URL</b>	<p>Only where <b>Command Type</b> = <i>Certificate Management</i> and <b>Action</b> = <i>SCEP</i></p> <p>Enter the URL of the SCEP server, e.g. <i>ht-</i></p>

Field	Description
	<p><i>tp://scep.bintec-elmeg.com:8080/scep/scep.dll</i></p> <p>Your CA administrator can provide you with the necessary data.</p>
<b>Subject Name</b>	<p>Only where <b>Command Type</b> = <i>Certificate Management</i> and <b>Action</b> = <i>SCEP</i></p> <p>Enter a subject name with attributes.</p> <p>Example: "CN=VPNServer, DC=mydomain, DC=com, c=DE"</p>
<b>CA Name</b>	<p>Only where <b>Command Type</b> = <i>Certificate Management</i> and <b>Action</b> = <i>SCEP</i></p> <p>Enter the name of the CA certificate of the certification authority (CA) from which you wish to request your certificate, e.g. <i>cawindows</i>. Your CA administrator can provide you with the necessary data.</p>
<b>Password</b>	<p>Only where <b>Command Type</b> = <i>Certificate Management</i> and <b>Action</b> = <i>SCEP</i></p> <p>To obtain certificates, you may need a password from the certification authority. Enter the password you received from the certification authority here.</p>
<b>Key Size</b>	<p>Only where <b>Command Type</b> = <i>Certificate Management</i> and <b>Action</b> = <i>SCEP</i></p> <p>Select the length of the key to be created. Possible values are <i>1024</i> (default value), <i>2048</i> and <i>4096</i>.</p>
<b>Autosave Mode</b>	<p>Only where <b>Command Type</b> = <i>Certificate Management</i> and <b>Action</b> = <i>SCEP</i></p> <p>Select whether your device automatically stores the various steps of the enrolment internally. This is an advantage if enrolment cannot be concluded immediately. If the status has not been saved, the incomplete registration cannot be completed. As soon as the enrolment is completed and the certificate has been downloaded from the CA server, it is automatically saved in the device configuration.</p> <p>The function is enabled by default.</p>



Field	Description
<b>Use CRL</b>	<p>Only where <b>Command Type</b> = <i>Certificate Management</i> and <b>Action</b> = <i>SCEP</i></p> <p>Define the extent to which certificate revocation lists (CRLs) are to be included in the validation of certificates issued by the owner of this certificate.</p> <p>Possible values:</p> <ul style="list-style-type: none"> <li>• <i>Auto</i> (default value): In case there is an entry for a CDP, CRL distribution point this should be evaluated in addition to the CRLs globally configured in the device.</li> <li>• <i>Yes</i>: CRLs are always checked.</li> <li>• <i>No</i>: No checking of CRLs.</li> </ul>
<b>Select radio</b>	<p>Only where <b>Command Type</b> = <i>5 GHz WLAN Bandscan, 5.8 GHz WLAN Bandscan</i> or <i>WLAN: Operation Mode</i></p> <p>Select the WLAN module on which to perform the frequency band scan.</p>
<b>WLC SSID</b>	<p>Only where <b>Command Type</b> = <i>WLC: VSS State</i></p> <p>Select the wireless network administered over the WLAN controller whose status should be changed.</p>
<b>Operation Mode (Active)</b>	<p>Only where <b>Command Type</b> = <i>WLAN: Operation Mode</i></p> <p>Select the required operating mode for the selected radio module if it currently has the status <i>Active</i>. You may select from any of the operating modes that your device supports. So the choice may vary from device to device.</p>
<b>Operation Mode (Inactive)</b>	<p>Only where <b>Command Type</b> = <i>WLAN: Operation Mode</i></p> <p>Select the required operating mode for the selected radio module if it currently has the status <i>Down</i>. You may select from any of the operating modes that your device supports. So the choice may vary from device to device.</p>

### 21.7.3 Options

You configure the schedule interval in the **Local Services->Scheduling->Options** menu.

The **Local Services->Scheduling->Options** menu consists of the following fields:

#### Fields in the Scheduling Options menu

Field	Description
<b>Schedule Interval</b>	<p>Select whether the schedule interval is to be enabled.</p> <p>Enter the interval in seconds after which the system checks whether events have occurred.</p> <p>Possible values are <i>0</i> to <i>65535</i>.</p> <p>The value <i>300</i> is recommended (5 minute accuracy).</p>

### 21.7.4 Configuration example - Time-controlled Tasks (Scheduling)

#### Requirements

- Basic configuration of the gateway.

#### Example scenario

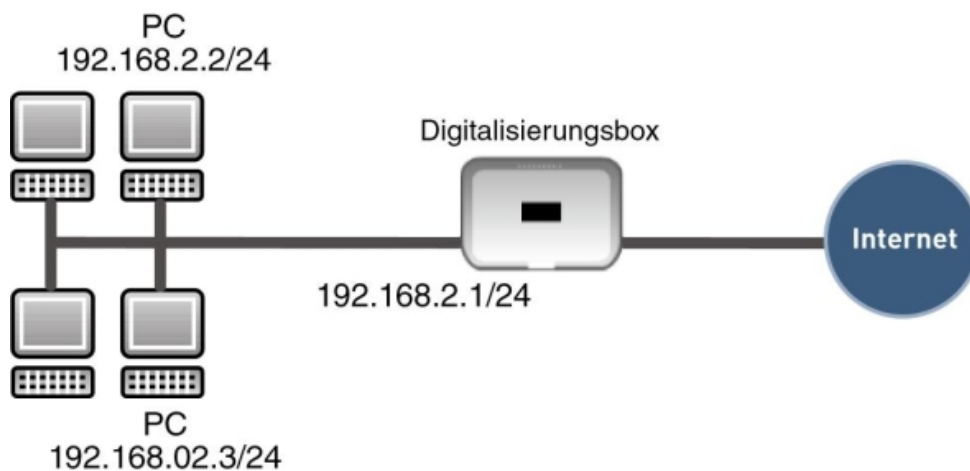

Example scenario Time-controlled Tasks

## Configuration target

- You want to reboot your gateway automatically overnight.
- The WLAN interface is to be suspended at the weekend.
- In addition, the configuration is to be backed up automatically once a month on a TFTP server.

## Overview of Configuration Steps

### Daily reboot

Field	Menu	Value
Event List	<b>Local Services -&gt; Scheduling -&gt; Trigger -&gt; New</b>	<i>New</i>
Description	<b>Local Services -&gt; Scheduling -&gt; Trigger -&gt; New</b>	<i>e.g. Trigger Reboot</i>
Event Type	<b>Local Services -&gt; Scheduling -&gt; Trigger -&gt; New</b>	<i>Time</i>
Time Condition	<b>Local Services -&gt; Scheduling -&gt; Trigger -&gt; New</b>	Condition Type = <i>Periods</i> , Condition Settings = <i>Daily</i>
Start Time	<b>Local Services -&gt; Scheduling -&gt; Trigger -&gt; New</b>	Hour <i>02</i> Minute <i>00</i>
Description	<b>Local Services -&gt; Scheduling -&gt; Actions -&gt; New</b>	<i>e.g. Reboot the devicet</i>
Command Type	<b>Local Services -&gt; Scheduling -&gt; Actions -&gt; New</b>	<i>Reboot</i>
Event List	<b>Local Services -&gt; Scheduling -&gt; Actions -&gt; New</b>	<i>Trigger Reboot</i>
Event List Condition	<b>Local Services -&gt; Scheduling -&gt; Actions -&gt; New</b>	<i>All</i>
Reboot device after	<b>Local Services -&gt; Scheduling -&gt; Actions -&gt; New</b>	<i>e.g. 60 Seconds</i>
Schedule Intervall	<b>Local Services -&gt; Scheduling -&gt; Options</b>	<i>Enabled, 55 sec</i>

### Suspending the WLAN interface

Field	Menu	Value
Event List	<b>Local Services -&gt; Scheduling -&gt; Trigger -&gt; New</b>	<i>New</i>

Field	Menu	Value
Description	<b>Local Services -&gt; Scheduling -&gt; Trigger -&gt; New</b>	e.g. <i>Trigger switch off WLAN interface</i>
Event Type	<b>Local Services -&gt; Scheduling -&gt; Trigger -&gt; New</b>	<i>Time</i>
Time Condition	<b>Local Services -&gt; Scheduling -&gt; Trigger -&gt; New</b>	Condition Type = <i>Periods</i> , Condition Settings = <i>Saturday - Sunday</i>
Start Time	<b>Local Services -&gt; Scheduling -&gt; Trigger -&gt; New</b>	Hour <i>00</i> Minute <i>00</i>
Stop Time	<b>Local Services -&gt; Scheduling -&gt; Trigger -&gt; New</b>	Hour <i>23</i> Minute <i>59</i>
Description	<b>Local Services -&gt; Scheduling -&gt; Actions -&gt; New</b>	e.g. <i>Switch off WLAN interface</i>
Command Type	<b>Local Services -&gt; Scheduling -&gt; Actions -&gt; New</b>	<i>Interface Status</i>
Event List	<b>Local Services -&gt; Scheduling -&gt; Actions -&gt; New</b>	<i>Trigger switch off WLAN interface</i>
Event List Condition	<b>Local Services -&gt; Scheduling -&gt; Actions -&gt; New</b>	<i>All</i>
Interface	<b>Local Services -&gt; Scheduling -&gt; Actions -&gt; New</b>	e.g. <i>vss1-0</i>
Set interface status	<b>Local Services -&gt; Scheduling -&gt; Actions -&gt; New</b>	<i>Down</i>
Schedule Intervall	<b>Local Services -&gt; Scheduling -&gt; Options</b>	<i>Enabled, 55 sec</i>

#### Monthly configuration backup

Field	Menu	Value
Event List	<b>Local Services -&gt; Scheduling -&gt; Trigger -&gt; New</b>	<i>New</i>
Description	<b>Local Services -&gt; Scheduling -&gt; Trigger -&gt; New</b>	e.g. <i>Trigger configuration backup</i>
Event Type	<b>Local Services -&gt; Scheduling -&gt; Trigger -&gt; New</b>	<i>Time</i>
Time Condition	<b>Local Services -&gt; Scheduling -&gt; Trigger -&gt; New</b>	Condition Type = <i>Day of Month</i> , Condition Settings = <i>1</i>

Field	Menu	Value
Start Time	<b>Local Services -&gt; Scheduling -&gt; Trigger -&gt; New</b>	Hour <i>03</i> Minute <i>00</i>
Description	<b>Local Services -&gt; Scheduling -&gt; Actions -&gt; New</b>	Configuration backup
Command Type	<b>Local Services -&gt; Scheduling -&gt; Actions -&gt; New</b>	Configuration Management
Event List	<b>Local Services -&gt; Scheduling -&gt; Actions -&gt; New</b>	Trigger configuration backup
Event List Condition	<b>Local Services -&gt; Scheduling -&gt; Actions -&gt; New</b>	All
Aktion	<b>Local Services -&gt; Scheduling -&gt; Actions -&gt; New</b>	Export configuration
Server URL	<b>Local Services -&gt; Scheduling -&gt; Actions -&gt; New</b>	e.g. <i>tftp://192.168.2.5</i>
CSV File Format	<b>Local Services -&gt; Scheduling -&gt; Actions -&gt; New</b>	<i>Enabled</i>
Remote File Name	<b>Local Services -&gt; Scheduling -&gt; Actions -&gt; New</b>	e.g. <i>monthly-backup.cf</i>
File Name in Flash	<b>Local Services -&gt; Scheduling -&gt; Actions -&gt; New</b>	<i>boot</i>
Configuration contains certificates/keys	<b>Local Services -&gt; Scheduling -&gt; Actions -&gt; New</b>	<i>Enabled</i>
Schedule Intervall	<b>Local Services -&gt; Scheduling -&gt; Options</b>	<i>Enabled, 55 sec</i>

## 21.8 Surveillance

In this menu, you can configure an automatic availability check for hosts or interfaces and automatic ping tests.

You can monitor temperature with devices from the **bintec WI** series.



### Note

This function cannot be configured on your device for connections that are authenticated via a RADIUS server.

## 21.8.1 Hosts

A list of all monitored hosts is displayed in the **Local Services->Surveillance->Hosts** menu.

### 21.8.1.1 Edit or New

Choose the  icon to edit existing entries. Choose the **New** button to create additional monitoring tasks.

The menu **Local Services->Surveillance->Hosts->New** consists of the following fields:

#### Fields in the Host Parameters menu

Field	Description
<b>Group ID</b>	<p>If the availability of a group of hosts or the default gateway is to be monitored by your device, select an ID for the group or the default gateway.</p> <p>The group IDs are automatically created from <i>0</i> to <i>255</i>. If an entry has not yet been created, a new group is created using the <i>New ID</i> option. If entries have been created, you can select one from the list of created groups.</p> <p>Each host to be monitored must be assigned to a group.</p> <p>The operation configured in <b>Interface</b> is only executed if no group member can be reached.</p>

#### Fields in the Trigger menu.

Field	Description
<b>Monitored IP Address</b>	<p>Enter the IP address of the host to be monitored.</p> <p>Possible values:</p> <ul style="list-style-type: none"> <li>• <i>Default Gateway</i> (default value): The default gateway is monitored.</li> <li>• <i>Specific</i>: Enter the IP address of the host to be monitored manually in the adjacent input field.</li> </ul>
<b>Source IP Address</b>	<p>Select how the IP address is to be determined that your device uses as the source address of the packet sent to the host to be</p>

Field	Description
	<p>monitored.</p> <p>Possible values:</p> <ul style="list-style-type: none"> <li>• <i>Automatic</i> (default value): The IP address is determined automatically.</li> <li>• <i>Specific</i>; Enter the IP address in the adjacent input field.</li> </ul>
<b>Interval</b>	<p>Enter the time interval (in seconds) to be used for checking the availability of hosts.</p> <p>Possible values are <i>1</i> to <i>65536</i>.</p> <p>The default value is <i>10</i>.</p> <p>Within a group, the smallest <b>Interval</b> of the group members is used.</p>
<b>Successful Trials</b>	<p>Specify how many pings need to be answered for the host to be regarded as accessible.</p> <p>You can use this setting to specify, for example, when a host is deemed to be accessible once more, and used again, instead of a backup device.</p> <p>Possible values are <i>1</i> to <i>65536</i>.</p> <p>The default value is <i>3</i>.</p>
<b>Unsuccessful Trials</b>	<p>Specify how many pings need to be unanswered for the host to be regarded as inaccessible.</p> <p>You can use this setting to specify, for example, when a host is deemed to be inaccessible, and that a backup device should be used.</p> <p>Possible values are <i>1</i> to <i>65536</i>.</p> <p>The default value is <i>3</i>.</p>
<b>Action to be performed</b>	<p>Select which <b>Action</b> should be run. For most actions, you select an <b>Interface</b> to which the <b>Action</b> relates.</p> <p>All physical and virtual interfaces can be selected.</p>

Field	Description
	<p>For each interface, select whether it is to be enabled ( <i>Enable</i>), disabled ( <i>Disable</i> default value), reset ( <i>Reset</i>), or the connection reestablished ( <i>Redial</i>).</p> <p>With <b>Action</b> = <i>Monitor</i> you can monitor the IP address that is specified under <b>Monitored IP Address</b>. This information can be used for other functions, such as the <b>Tracking IP Address</b>.</p>

## 21.8.2 Interfaces

A list of all monitored hosts is displayed in the **Local Services->Surveillance->Interfaces** menu.

### 21.8.2.1 Edit or New

Choose the  icon to edit existing entries. Choose the **New** button to set up monitoring for other interfaces.

The menu **Local Services->Surveillance->Interfaces->New** consists of the following fields:

#### Fields in the **Basic Parameters** menu.

Field	Description
<b>Monitored Interface</b>	Select the interface on your device that is to be monitored.
<b>Trigger</b>	<p>Select the state or state transition of <b>Monitored Interface</b> that is to trigger a particular <b>Interface Action</b>.</p> <p>Possible values:</p> <ul style="list-style-type: none"> <li>• <i>Interface goes up</i> (default value)</li> <li>• <i>Interface goes down</i></li> </ul>
<b>Interface Action</b>	<p>Select the action that is to follow the state or state transition defined in <b>Trigger</b>.</p> <p>The action is applied to the Interface(s) selected in <b>Interface</b>.</p> <p>Possible values:</p> <ul style="list-style-type: none"> <li>• <i>Enable</i> (default value): Activation of interface(s)</li> </ul>



Field	Description
	<ul style="list-style-type: none"> <li>• <i>Disable</i>: Deactivation of interface(s)</li> </ul>
<b>Interface</b>	<p>Select the interface(s) for which the action defined in <b>Interface</b> is to be performed.</p> <p>You can choose all physical and virtual interfaces as well as options <i>All PPP Interfaces</i> and <i>All IPsec Interfaces</i>.</p>

### 21.8.3 Ping Generator

In the **Local Services->Surveillance->Ping Generator** menu, a list of all configured, automatically generated pings is displayed.

#### 21.8.3.1 Edit or New

Choose the  icon to edit existing entries. Choose the **New** button to create additional pings.

The menu **Local Services->Surveillance->Ping Generator->New** consists of the following fields:

#### Fields in the **Basic Parameters** menu.

Field	Description
<b>Destination IP Address</b>	Enter the IP address to which the ping is automatically sent.
<b>Source IP Address</b>	<p>Enter the source IP address of the outgoing ICMP echo request packets.</p> <p>Possible values:</p> <ul style="list-style-type: none"> <li>• <i>Automatic</i>: The IP address is determined automatically.</li> <li>• <i>Specific</i> (default value): Enter the IP address in the adjacent input field e.g. to test a particular extended route.</li> </ul>
<b>Interval</b>	<p>Enter the interval in seconds during which the ping is sent to the address specified in <b>Remote IP Address</b>.</p> <p>Possible values are <i>1</i> to <i>65536</i>.</p> <p>The default value is <i>10</i>.</p>

Field	Description
<b>Trials</b>	<p>Enter the number of ping tests to be performed until <b>Destination IP Address</b> as <i>Unreachable</i> applies.</p> <p>The default value is 3.</p>

## 21.9 UPnP

Universal Plug and Play (UPnP) makes it possible to use current messenger services (e.g. real time video/audio conferencing) as peer-to-peer communication where one of the peers lies behind a NAT-enabled gateway.

UPnP enables (mostly) Windows-based operating systems to take control of other devices with UPnP functionality on the local network. These include gateways, access points and print servers. No special device drivers are needed as known common protocols are used, such as TCP/IP, HTTP and XML.

Your gateway makes it possible to use the subsystem of the Internet Gateway Device (IGD) from the UPnP function range.

In a network behind a NAT-enabled gateway, the UPnP-configured computers act as LAN UPnP clients. To do this, the UPnP function on the PC must be enabled.

The pre-configured port used for UPnP communication between LAN UPnP clients and the gateway is 5678. The LAN UPnP client acts as a so-called service control point, i.e. it recognizes and controls the UPnP devices on the network.

The ports assigned dynamically by, for example, MSN Messenger, lie in the range from 5004 to 65535. The ports are released internally to the gateway on demand, i.e. when an audio/video transfer is started in Messenger. When the application is closed, the ports are immediately closed again.

The peer-to-peer-communication is initiated via public SIP servers with only the information from the two clients being forwarded. The clients then communicate directly with one another.

For further information about UPnP, see [www.upnp.org](http://www.upnp.org).

### 21.9.1 Interfaces

In this menu, you configure the UPnP settings individually for each interface of your gateway.

You can determine whether UPnP requests from clients are accepted by each interface (for

requests from the local network) and/or whether the interface can be controlled via UPnP requests.

The menu **Local Services->UPnP->Interfaces** consists of the following fields:

#### Fields in the Interfaces menu.

Field	Description
<b>Interface</b>	Shows the name of the interface for which the UPnP settings are to be made. The entry cannot be changed.
<b>Answer to client request</b>	Determine whether UPnP requests from clients are to be answered via the particular interface (from the local network).  The function is enabled with <i>Enabled</i> .  The function is disabled by default.
<b>Interface is UPnP controlled</b>	Determine whether the NAT configuration of this interface is controlled by UPnP.  The function is enabled with <i>Enabled</i> .  The function is disabled by default.

## 21.9.2 General

In this menu, you make the basic UPnP settings.

The **Local Services->UPnP->General** menu consists of the following fields:

#### Fields in the General menu.

Field	Description
<b>UPnP Status</b>	Decide how the gateway processes UPnP requests from the LAN.  The function is enabled with <i>Enabled</i> . The gateway proceeds with UPnP releases in accordance with the parameters contained in the request from the LAN UPnP client, independently of the IP address of the requesting LAN UPnP client.  The function is disabled by default. The gateway rejects UPnP requests, NAT releases are not made.

Field	Description
<b>UPnP TCP Port</b>	<p>Enter the number of the port on which the gateway listens for UPnP requests.</p> <p>The possible values are <i>1</i> to <i>65535</i>, the default value is <i>5678</i>.</p>

## 21.10 HotSpot Gateway



### Important

The Hotspot Gateway must not be operated with IPv6 enabled, since IPv6 data traffic is not registered by the Hotspot Gateway and, therefore, cannot be controlled.

The **HotSpot Solution** allows provision of public Internet accesses (using WLAN or wired Ethernet). The solution is adapted to setup of smaller and larger Hotspot solutions for cafes, hotels, companies, communal residences, campgrounds, etc.

The **HotSpot Solution** consists of a bintec elmegbintec elmeg gateway installed onsite (with its own WLAN access point or additional connected WLAN device or wired LAN) and of the Hotspot server, centrally located at a computing centre. The operator account is administered on the server via an administration terminal (e.g., a hotel reception PC); this includes functions such as registration entry, generating tickets, statistical analysis, etc.

### Login sequence at the Hotspot server

- When a new user connects with the Hotspot, he/she is automatically assigned an IP address via DHCP.
- As soon as he attempts to access any Internet site with a browser, the user is redirected to the home/login page.
- After the user has entered the registration data (user/password), these are sent to the central RADIUS server (Hotspot server) as RADIUS registration.
- Following successful registration, the gateway opens Internet access.
- For each user, the gateway sends regular additional information to the RADIUS server for recording accounting data.
- When the ticket expires, the user is automatically logged off and again redirected to the home/login page.

### Requirements

To operate a Hotspot, the customer requires:

- a bintec elmegbintec elmeg device as hotspot gateway with active Internet access and configured hotspot server entries for login and accounting (see menu **System Management->Remote Authentication->RADIUS->New** with **Group Description** *default group 0*)
- bintec elmegbintec elmeg Hotspot hosting (article number 5510000198)
- Access data
- Documentation
- Software licensing

Please note that you must first activate the licence.

Go to [www.bintec-elmeg.com](http://www.bintec-elmeg.com) then **Service/Support -> Services -> Online Services**.

- Enter the required data (please note the relevant explanations on the license sheet), and follow the instructions of the online licensing.

- You then receive the Hotspot server's login data.



#### Note

Activation may require 2-3 business days.

## Access data for gateway configuration

RADIUS Server IP	62.245.165.180
RADIUS Server Password	Set by bintec elmeg GmbH
Domain	Individually set for customers by customer/dealer
Walled Garden Network	Individually set for customers by customer/dealer
Walled Garden Server URL	Individually set for customers by customer/dealer
Terms & Conditions URL	Individually set for customers by customer/dealer

## Access data for configuration of the Hotspot server

Admin URL	<a href="https://hotspot.bintec-elmeg.com/">https://hotspot.bintec-elmeg.com/</a>
Username	Individually set by bintec elmeg
Password	Individually set by bintec elmeg



### Note

Also refer to the WLAN Hotspot Workshop that is available to download from [www.bintec-elmeg.com](http://www.bintec-elmeg.com)

## 21.10.1 HotSpot Gateway

In the **HotSpot Gateway** menu, you can configure the bintec elmeg gateway installed onsite for the **Hotspot Solution**.

A list of all configured hotspot networks is displayed in the **Local Services->HotSpot Gateway->HotSpot Gateway** menu.

You can use the **Enabled** option to enable or disable the corresponding entry.

### 21.10.1.1 Edit or New

You configure the hotspot networks in the **Local Services->HotSpot Gateway->HotSpot Gateway->**  menu. Choose the **New** button to set up additional Hotspot networks.

The **Local Services->HotSpot Gateway->HotSpot Gateway->**  menu consists of the following fields:

#### Fields in the menu Basic Parameters

Field	Description
Interface	Choose the interface to which the Hotspot LAN or WLAN is connected. When operating over LAN, enter the Ethernet interface here (e. g. en1-0). If operating over WLAN, the WLAN interface to which the access point is connected must be selected.



#### Caution

For security reasons you cannot configure your device over an interface that is configured for the Hotspot. Therefore take care when selecting the interface you want to use for the Hotspot.

If you select the interface over which the current configuration session is running, the current connection will be lost.

Field	Description
	You must then log in again over a reachable interface that is not configured for the Hotspot to configure your device.
<b>Domain at the HotSpot Server</b>	Enter the domain name that you used when setting up the HotSpot server for this customer. The domain name is required so that the Hotspot server can distinguish between the different clients (customers).
<b>Walled Garden</b>	<p>Enable this function if you want to define a limited and free area of websites (intranet).</p> <p>The function is not activated by default.</p>
<b>Walled Network / Net-mask</b>	<p>Only if <b>Walled Garden</b> is enabled.</p> <p>Enter the network address of the <b>Walled Network</b> and the corresponding <b>Netmask</b> of the intranet server.</p> <p>For the address range resulting from <b>Walled Network / Net-mask</b>, clients require no authentication.</p> <p>Example: Enter 192.168.0.0 / 255.255.255.0, if all IP addresses from 192.168.0.0 to 19.168.0.255 are free. Enter 192.168.0.1 / 255.255.255.255, if only the IP address 192.168.0.1 is free.</p>
<b>Walled Garden URL</b>	<p>Only if <b>Walled Garden</b> is enabled.</p> <p>Enter the <b>Walled Garden URL</b> of the intranet server. Freely accessible websites must be reachable over this address.</p>
<b>Terms &amp;Conditions</b>	<p>Only if <b>Walled Garden</b> is enabled.</p> <p>In the <b>Terms &amp;Conditions</b> input field, enter the address of the general terms and conditions on the intranet server, or public server, e.g., <a href="http://www.webserver.de/agb.htm">http://www.webserver.de/agb.htm</a>. The page must lie within the address range of the walled garden network.</p>
<b>Additional freely accessible Domain Names</b>	<p>Only if <b>Walled Garden</b> is enabled.</p> <p>Add further URLs or IP addresses with <b>Add</b>. The web pages can be accessed via these additional freely accessible addresses.</p>

Field	Description
<b>Post Login URL</b>	Here you can specify the URL a user is redirected to after logging in to the Hotspot Solution.
<b>Language for login window</b>	<p>Here you can choose the language for the start/login page.</p> <p>The following languages are supported: <i>English, Deutsch, Italiano, Français, Español, Português</i> and <i>Netherlands</i>.</p> <p>The language can be changed on the start/login page at any time.</p>

The menu **Advanced Settings** consists of the following fields:

#### Fields in the menu **Advanced Settings**

Field	Description
<b>Ticket Type</b>	<p>Select the ticket type.</p> <p>Possible values:</p> <ul style="list-style-type: none"> <li>• <i>Voucher</i>: Only the user name must be entered. Define a default password in the input field.</li> <li>• <i>Username/Password</i> (default value): User name and password must be entered.</li> </ul>
<b>Allowed HotSpot Client</b>	<p>Here you can define which type of users can log in to the Hotspot.</p> <p>Possible values:</p> <ul style="list-style-type: none"> <li>• <i>All</i>: All clients are approved.</li> <li>• <i>DHCP Client</i>: Prevents users who have not received an IP address from DHCP from logging in.</li> </ul>
<b>Login Frameset</b>	<p>Enable or disable the login window.</p> <p>The login window on the HTML homepage consists of two frames.</p> <p>When the function is enabled, the login form displays on the left-hand side.</p> <p>When the function is disabled, only the website with information,</p>



Field	Description
	<p>advertising and/or links to freely accessible websites is displayed.</p> <p>The function is enabled by default.</p>
<b>Pop-Up window for status indication</b>	<p>Specify whether the device uses pop-up windows to display the status.</p> <p>The function is enabled by default.</p>
<b>Default Idle Timeout</b>	<p>Enable or disable the <b>Default Idle Timeout</b>. If a hotspot user does not trigger any data traffic for a configurable length of time, they are logged out of the hotspot.</p> <p>The function is enabled by default.</p> <p>The default value is <i>600</i> seconds.</p>

## 21.10.2 Options

In the **Local Services->HotSpot Gateway->Options** menu, general settings are performed for the hotspot.

The **Local Services->HotSpot Gateway->Options** menu consists of the following fields:

### Fields in the **Basic Parameters** menu.

Field	Description
<b>Host for multiple locations</b>	If several locations (branches) are set up on the Hotspot server, enter the value of the NAS identifier (RADIUS server parameter) that has been registered for this location on the Hotspot server.

## 21.11 Wake-On-LAN

With the function **Wake-On-LAN** you can start network devices that are switched off via an integrated network card. The network card also needs a power supply, even when the computer is switched off. You can use filters and rule chains to define the conditions that need to be met to send the so-called magic packet, and select the interfaces that are to be monitored for the defined rule chains. Configuring the filters and rule chains is largely like configuring filters and rule chains in the menu **Access Rules**.

## 21.11.1 Wake-On-LAN Filter

The menu **Local Services->Wake-On-LAN->Wake-On-LAN Filter** displays a list of all the WOL filters that have been configured.

### 21.11.1.1 Edit or New

Choose the  icon to edit existing entries. Choose the **New** button to enter additional filters.

The **Local Services->Wake-On-LAN->Wake-On-LAN Filter->New** menu consists of the following fields:

#### Fields in the menu Basic Parameters

Field	Description
<b>Description</b>	Enter the name of the filter.
<b>Service</b>	<p>Select one of the preconfigured services. The extensive range of services configured ex works includes the following:</p> <ul style="list-style-type: none"> <li>• <i>activity</i></li> <li>• <i>apple-qt</i></li> <li>• <i>auth</i></li> <li>• <i>charge</i></li> <li>• <i>clients_1</i></li> <li>• <i>daytime</i></li> <li>• <i>dhcp</i></li> <li>• <i>discard</i></li> </ul> <p>The default value is <i>Any</i>.</p>
<b>Protocol</b>	<p>Select a protocol.</p> <p>The option <i>Any</i> (default value) matches any protocol.</p>
<b>Type</b>	<p>Only for <b>Protocol</b> = <i>ICMP</i></p> <p>Select the type.</p> <p>Possible values: <i>Any, Echo reply, Destination unreachable, Source quench, Redirect, Echo, Time exceeded,</i></p>

Field	Description
	<p><i>Timestamp, Timestamp reply.</i></p> <p>See RFC 792.</p> <p>The default value is <i>Any</i>.</p>
<b>Connection State</b>	<p>With <b>Protocol</b> = <i>TCP</i>, you can define a filter that takes the status of the TCP connections into account.</p> <p>Possible values:</p> <ul style="list-style-type: none"> <li>• <i>Established</i>: All TCP packets that would not open any new TCP connection on routing over the gateway match the filter.</li> <li>• <i>Any</i> (default value): All TCP packets match the filter.</li> </ul>
<b>Destination IPv4 Address/Netmask</b>	<p>Enter the destination IPv4 address of the data packets and the corresponding netmask.</p> <p>Possible values:</p> <ul style="list-style-type: none"> <li>• <i>Any</i> (default value): The destination IP address/netmask are not specified.</li> <li>• <i>Host</i>: Enter the destination IP address of the host.</li> <li>• <i>Network</i>: Enter the destination network address and the corresponding netmask.</li> </ul>
<b>Destination IPv6 Address/Length</b>	<p>Enter the destination IPv6 address of the data packets and the prefix length.</p> <p>Possible values:</p> <ul style="list-style-type: none"> <li>• <i>Any</i> (default value): The destination IP address/length are not specified.</li> <li>• <i>Host</i>: Enter the destination IP address of the host.</li> <li>• <i>Network</i>: Enter the destination network address and the prefix length.</li> </ul>
<b>Destination Port/Range</b>	<p>Only for <b>Protocol</b> = <i>TCP, UDP or TCP/UDP</i></p> <p>Enter a destination port number or a range of destination port numbers.</p> <p>Possible values:</p> <ul style="list-style-type: none"> <li>• <i>-All-</i> (default value): The destination port is not specified.</li> <li>• <i>Specify port</i>: Enter a destination port.</li> </ul>

Field	Description
	<ul style="list-style-type: none"> <li>• <i>Specify port range</i>: Enter a destination port range.</li> </ul>
<b>Source IPv4 Address/Netmask</b>	<p>Enter the source IPv4 address of the data packets and the corresponding netmask.</p> <p>Possible values:</p> <ul style="list-style-type: none"> <li>• <i>Any</i> (default value): The source IP address/netmask are not specified.</li> <li>• <i>Host</i>: Enter the source IP address of the host.</li> <li>• <i>Network</i>: Enter the source network address and the corresponding netmask.</li> </ul>
<b>Source IPv6 Address/Length</b>	<p>Enter the source IPv6 address of the data packets and the prefix length.</p> <p>Possible values:</p> <ul style="list-style-type: none"> <li>• <i>Any</i> (default value): The source IP address/length are not specified.</li> <li>• <i>Host</i>: Enter the source IP address of the host.</li> <li>• <i>Network</i>: Enter the source network address and the prefix length.</li> </ul>
<b>Source Port/Range</b>	<p>Only for <b>Protocol</b> = <i>TCP</i>, <i>UDP</i> or <i>TCP/UDP</i></p> <p>Enter a source port number or a range of source port numbers.</p> <p>Possible values:</p> <ul style="list-style-type: none"> <li>• <i>-All-</i> (default value): The source port is not specified.</li> <li>• <i>Specify port</i>: Enter a source port.</li> <li>• <i>Specify port range</i>: Enter a source port range.</li> </ul>
<b>DSCP/TOS Filter (Layer 3)</b>	<p>Select the Type of Service (TOS).</p> <p>Possible values:</p> <ul style="list-style-type: none"> <li>• <i>Ignore</i> (default value): The type of service is ignored.</li> <li>• <i>DSCP Binary Value</i>: Differentiated Services Code Point according to RFC 3260 is used to signal the priority of IP packets (indicated in binary format, 6 bit).</li> <li>• <i>DSCP Decimal Value</i>: Differentiated Services Code Point according to RFC 3260 is used to signal the priority of IP</li> </ul>

Field	Description
	<p>packets (indicated in decimal format).</p> <ul style="list-style-type: none"> <li>• <i>DSCP Hexadecimal Value</i>: Differentiated Services Code Point according to RFC 3260 is used to signal the priority of IP packets (indicated in hexadecimal format).</li> <li>• <i>TOS Binary Value</i>: The TOS value is specified in binary format, e.g. 00111111.</li> <li>• <i>TOS Decimal Value</i>: The TOS value is specified in decimal format, e.g. 63.</li> <li>• <i>TOS Hexadecimal Value</i>: The TOS value is specified in hexadecimal format, e.g. 3F.</li> </ul>
<b>COS Filter (802.1p/Layer 2)</b>	<p>Enter the service class of the IP packets (Class of Service, CoS).</p> <p>Value range 0 to 7.</p> <p>The default value is 0.</p> <p>The default value is <i>Ignore</i>.</p>

## 21.11.2 WOL Rules

The menu **Local Services->Wake-On-LAN->WOL Rules** displays a list of all the WOL rules that have been configured.

### 21.11.2.1 Edit or New

Choose the  icon to edit existing entries. Choose the **New** button to enter additional rules.

The **Local Services->Wake-On-LAN->WOL Rules->New** menu consists of the following fields:

#### Fields in the menu Basic Parameters

Field	Description
<b>Wake-On-LAN Rule Chain</b>	<p>Select whether to create a new rule chain or to edit an existing one.</p> <p>Possible values:</p> <ul style="list-style-type: none"> <li>• <i>New</i> (default value): You can create a new rule chain with this</li> </ul>

Field	Description
	<p>setting.</p> <ul style="list-style-type: none"> <li>• <i>&lt;Name of the rule chain&gt;</i>: Shows a rule chain that has already been created, which you can select and edit.</li> </ul>
<b>Description</b>	<p>Only where <b>Wake-On-LAN Rule Chain</b> = <i>New</i></p> <p>Enter the name of the rule chain.</p>
<b>Wake-On-LAN Filter</b>	<p>Select a WOL filter.</p> <p>If the rule chain is new, select the filter to be set at the first point of the rule chain.</p> <p>If the rule chain already exists, select the filter to be attached to the rule chain.</p> <p>To select a filter, at least one filter must be configured in the <b>Local Services-&gt;Wake-On-LAN-&gt;WOL Rules</b> menu.</p>
<b>Action</b>	<p>Define the action to be taken for a filtered data packet.</p> <p>Possible values:</p> <ul style="list-style-type: none"> <li>• <i>Invoke WOL if filter matches</i>: Run WOL if the filter matches.</li> <li>• <i>Invoke if filter does not match</i>: Run WOL if the filter does not match.</li> <li>• <i>Deny WOL if filter matches</i>: Do not run WOL if the filter matches.</li> <li>• <i>Deny WOL if filter does not match</i>: Do not run WOL if the filter does not match.</li> <li>• <i>Ignore rule and skip to next rule</i>: This rule is ignored and the next one in the chain is examined.</li> </ul>
<b>Type</b>	<p>Select whether the Wake on LAN magic packet is to be sent as a UDP packet or as an Ethernet frame via the interface specified in <b>Send WOL packet over Interface</b>.</p>
<b>Send WOL packet over Interface</b>	<p>Select the interface which is to be used to send the Wake on LAN magic packet.</p>
<b>Target MAC-Address</b>	<p>Only where <b>Action</b> = <i>Invoke WOL if filter matches</i> and <i>Invoke if filter does not match</i></p>

Field	Description
	Enter the MAC address of the network device that is to be enabled using WOL.
<b>Password</b>	<p>Only where <b>Action</b> = <i>Invoke WOL if filter matches</i> and <i>Invoke if filter does not match</i></p> <p>If the network device that is to be enabled supports the "SecureOn" function, enter the corresponding password for this device here. The device is only enabled if the MAC address and password are correct.</p>

### 21.11.3 Interface Assignment

In this menu, the configured rule chains are assigned to individual interfaces which are then monitored for these rule chains.

A list of all configured interface assignments is displayed in the **Local Services->Wake-On-LAN->Interface Assignment** menu.

#### 21.11.3.1 Edit or New

Choose the  icon to edit existing entries. Choose the **New** button to create other entries.

The **Local Services->Wake-On-LAN->Interface Assignment->New** menu consists of the following fields:

#### Fields in the menu Basic Parameters

Field	Description
<b>Interface</b>	Select the interface for which a configured rule chain is to be assigned.
<b>Rule Chain</b>	Select a rule chain.

### 21.12 Trace Interface

The menu **Trace Interface** allows recording the data traffic of a specific interface and allows you to save the recording as a PCAP file once the process has been stopped.

## 21.12.1 Trace Interface

screen----

### Fields in the Trace Settings menu

Field	Description
<b>Interface Selection</b>	Select the interface the data traffic of which is to be recorded.
<b>Trace Mode</b>	Here you can choose the layers on which the data traffic of the selected interface is to be recorded. Available choices are: <ul style="list-style-type: none"><li>• <i>Layer 2</i></li><li>• <i>PPP</i></li><li>• <i>Layer 3</i></li><li>• <i>IP</i></li></ul>

As soon as you start the recording with the **START** button, a window informs you about the recording. During recording you can leave the menu and use the GUI as usual. Once you stop the recording with the **STOP** button, information on the created file is displayed and you can either delete or save it as a PCAP file.



## Chapter 22 Maintenance

This menu provides you with numerous functions for maintaining your device. It firstly provides a menu for testing availability within the network. You can manage your system configuration files. If more recent system software is available, you can use this menu to install it. If you need other languages for the configuration interface, you can import these. You can also trigger a system reboot in this menu.

### 22.1 Log out Users

It can happen that an incompletely terminated configuration session affects functions of the configuration interface. In this case, all active configurations can be checked and - if applicable - terminated.

#### 22.1.1 Log out Users

In this menu, you are presented with a list of all active configuration sessions.

##### Fields in the manu Log out Users

Field	Description
<b>Class</b>	Displays the class the signed-on user belongs to.
<b>User</b>	Displays the user name.
<b>Remote IP Address</b>	Displays the IP address from which the connection has been established. This may be the address of a PC, but it may also be the address of an intermediate router.
<b>Expires</b>	Displays when the connection will be automatically terminated by the device.
<b>Log out immediately</b>	If you activate the check box, this user will be disconnected from the system when you click <b>Logout</b> .

##### 22.1.1.1 Logout Options

After you have confirmed your selection of connections to be terminated with **Logout** you can choose if any configuration related to the connections is to be saved before the user is actually disconnected, and in which way.

## 22.2 Diagnostics

In the **Maintenance->Diagnostics** menu, you can test the availability of individual hosts, the resolution of domain names and certain routes.

### 22.2.1 Ping Test

You can use the ping test to check whether a certain host in the LAN or an internet address can be reached.

#### Fields in the Ping Test menu

Field	Description
<b>Test Ping Mode</b>	Select the IP version to be used for the ping test.  Possible values: <ul style="list-style-type: none"> <li>• <i>IPv4</i></li> <li>• <i>IPv6</i></li> </ul>
<b>Test Ping Address</b>	Enter the IP address to be tested.
<b>Use Interface</b>	Only for <b>Test Ping Mode</b> = <i>IPv6</i>  For link local addresses select the interface to be used for the ping test. <i>Default</i> can be used for global addresses.

Pressing the **Go** button starts the ping test. The **Output** field displays the ping test messages.

### 22.2.2 DNS Test

The DNS test is used to check whether the domain name of a particular host is correctly resolved. The **Output** field displays the DNS test messages. The ping test is launched by entering the domain name to be tested in **DNS Address** and clicking the **Go** button.

### 22.2.3 Traceroute Test

You use the traceroute test to display the route to a particular address (IP address or domain name), if this can be reached.

**Fielder in the Traceroute Test menu**

Field	Description
<b>Traceroute Mode</b>	Select the IP version to be used for the Traceroute test.  Possible values: <ul style="list-style-type: none"> <li>• <i>IPv4</i></li> <li>• <i>IPv6</i></li> </ul>
<b>Traceroute Address</b>	Enter the IP address to be tested.

Pressing the **Go** button starts the Traceroute test. The **Output** field displays the traceroute test messages.

## 22.3 Memory Card

**be.IP plus** features additional Flash memory that can store files like, e.g., music on hold and voice mail announcements. You can manage this memory in the **Memory Card** menu.

### 22.3.1 Memory Card

The menu card **Memory Card** informs you about the size and the allocated space of the internal memory as well as about access permissions. The **Directory Tree** below lets you search the directories of the memory and supports basic operations like deleting and downloading files.

The **New Directory** button opens a pop up window that allows you to add a new directory at the location in the directory tree you have currently selected.

The **Add File** button opens a pop up windows that allows you to upload a new file to the directory you have currently selected.

## 22.4 Software & Configuration

You can use this menu to manage the software version of your device, your configuration files and the language of the **GUI**.

## 22.4.1 Options

Your device contains the version of the system software available at the time of production. More recent versions may have since been released. You may therefore need to carry out a software update.

Every new system software includes new features, better performance and any necessary bugfixes from the previous version. You can find the current system software at [www.bintec-elmeg.com](http://www.bintec-elmeg.com). The current documentation is also available here.



### Important

If you want to update your software, make sure you consider the corresponding release notes. These describe the changes implemented in the new system software.

The result of an interrupted update (e.g. power failure during the update) could be that your gateway no longer boots. Do not turn your device off during the update.

An update of BOOTmonitor and/or Logic is recommended in a few cases. In this case, the release notes refer expressly to this fact. Only update BOOTmonitor or Logic if bintec elmeg GmbH explicitly recommends this.

### Flash

Your device saves its configuration in configuration files in the flash EEPROM (Electrically Erasable Programmable Read Only Memory). The data even remains stored in the flash when your device is switched off.

### RAM

The current configuration and all changes you set on your device during operation are stored in the working memory (RAM). The contents of the RAM are lost if the device is switched off. So if you modify your configuration and want to keep these changes for the next time you start your device, you must save the modified configuration in the flash memory before switching off: The **Save configuration** button over the navigation area of the **GUI**. This configuration is then saved in the flash in a file with the name `boot`. When you start your device, the `boot` configuration file is used by default.

### Actions

The files in the flash memory can be copied, moved, erased and newly created. It is also possible to transfer configuration files between your device and a host via HTTP.

## Configuration file format

The file format of the configuration file allows encryption and ensures compatibility when restoring the configuration on the gateway in various system software versions. This is a CSV format, which can be read and modified easily. In addition, you can view the corresponding file clearly using Microsoft Excel for example. The administrator can store encrypted backup files for the configuration. When the configuration is sent by e-mail (e.g for support purposes) confidential configuration data can be protected fully if required. You can save or import files with the actions "Export configuration", "Export configuration with status information" and "Load configuration". If you want to save a configuration file with the action "Export configuration" or "Export configuration with status information", you can choose whether the configuration file is saved encrypted or without encryption.



### Caution

If you have saved a configuration file in an old format via the SNMP shell with the `put` command, there is no guarantee that it can be reloaded to the device. As a result, the old format is no longer recommended.

The **Maintenance->Software & Configuration->Options** menu consists of the following fields:

#### Fields in the **Currently Installed Software** menu.

Field	Description
<b>BOSS</b>	Shows the current software version loaded on your device.
<b>System Logic</b>	Shows the current system logic loaded on your device.
<b>ADSL Logic</b>	Shows the current version of the ADSL logic loaded on your device.

#### Fields in the **Software and Configuration Options** menu.

Field	Description
<b>Action</b>	<p>Select the action you wish to execute.</p> <p>After each task, a window is displayed showing the other steps that are required.</p> <p>Possible values:</p> <ul style="list-style-type: none"> <li>• <i>No Action</i> (default value):</li> </ul>

Field	Description
	<ul style="list-style-type: none"> <li>• <i>Export configuration</i>: The configuration file <b>Current File Name in Flash</b> is transferred to your local host. If you click the <b>Go</b> button, a dialog box is displayed, in which you can select the storage location on your PC and enter the desired file name.</li> <li>• <i>Import configuration</i>: Under <b>Filename</b> select a configuration file you want to import. Please note: Click <b>Go</b> to first load the file under the name <i>boot</i> in the flash memory for the device. You must restart the device to enable it.</li> </ul> <p>Please note: The files to be imported must be in CSV format!</p> <ul style="list-style-type: none"> <li>• <i>Copy configuration</i>: The configuration file in the <b>Source File Name</b> field is saved as <b>Destination File Name</b>.</li> <li>• <i>Delete configuration</i>: The configuration in the <b>Select file</b> field is deleted.</li> <li>• <i>Rename configuration</i>: The configuration file in the <b>Select file</b> field is renamed to <b>New File Name</b>.</li> <li>• <i>Restore backup configuration</i>: Only if, under <b>Save configuration</b> with the setting <i>Save configuration and back up previous boot configuration</i> the current configuration was saved as boot configuration and the previous boot configuration was also archived.</li> </ul> <p>You can load back the archived boot configuration.</p> <ul style="list-style-type: none"> <li>• <i>Delete software/firmware</i>: The file in the <b>Select file</b> field is deleted.</li> <li>• <i>Import language</i>: You can import additional language versions of the <b>GUI</b> into your device. You can download the files to your PC from the download area at <a href="http://www.bintec-elmeg.com">www.bintec-elmeg.com</a> and from there import them to your device</li> <li>• <i>Update system software</i>: You can launch an update of the system software, the ADSL logic and the BOOTmonitor.</li> <li>• <i>Import Voice Mail Wave Files</i>: (Only displayed if an SD card is inserted, if supported by you device) In <b>file name</b>, select the <i>vms_wavfiles.zip</i> file that you wish to import.</li> <li>• <i>Export configuration with state information</i>: The active configuration from the RAM is transferred to your local host. If you click the <b>Go</b> button, a dialog box is displayed, in which you can select the storage location on your</li> </ul>

Field	Description
	PC and enter the desired file name.
<b>Current File Name in Flash</b>	<p>For <b>Action</b> = <i>Export configuration</i></p> <p>Select the configuration file to be exported.</p>
<b>Include certificates and keys</b>	<p>For <b>Action</b> = <i>Export configuration, Export configuration with state information</i></p> <p>Define whether the selected <b>Action</b> should also be applied for certificates and keys.</p> <p>The function is activated by selecting <i>Enabled</i>.</p> <p>The function is enabled by default.</p>
<b>Configuration Encryption</b>	<p>Only for <b>Action</b> = <i>Import configuration, Export configuration, Export configuration with state information</i>. Define whether the data of the selected <b>Action</b> are to be encrypted.</p> <p>The function is activated by selecting <i>Enabled</i>.</p> <p>The function is disabled by default.</p> <p>If the function is enabled, you can enter the <b>Password</b> in the text field.</p>
<b>Filename</b>	<p>Only for <b>Action</b> = <i>Import configuration, Import language Update system software</i>.</p> <p>Enter the path and name of the file or select the file with <b>Browse...</b> via the explorer/finder.</p>
<b>Source File Name</b>	<p>Only for <b>Action</b> = <i>Copy configuration</i></p> <p>Select the source file to be copied.</p>
<b>Destination File Name</b>	<p>Only for <b>Action</b> = <i>Copy configuration</i></p> <p>Enter the name of the copy.</p>
<b>Select file</b>	<p>Only for <b>Action</b> = <i>Rename configuration, Delete configuration</i> or <i>Delete software/firmware</i></p>

Field	Description
	Select the file or configuration to be renamed or deleted.
<b>New File Name</b>	<p>Only for <b>Action</b> = <i>Rename configuration</i></p> <p>Enter the new name of the configuration file.</p>
<b>Source Location</b>	<p>Only for <b>Action</b> = <i>Update system software</i></p> <p>Select the source of the update.</p> <p>Possible values:</p> <ul style="list-style-type: none"> <li>• <i>Local File</i> (default value): The system software file is stored locally on your PC.</li> <li>• <i>HTTP Server</i>: The file is stored on a remote server specified in the <b>URL</b>.</li> <li>• <i>Current Software from Update Server</i>: The file is on the official update server.</li> </ul>
<b>URL</b>	<p>Only for <b>Source Location</b> = <i>HTTP Server</i></p> <p>Enter the URL of the update server from which the system software file is loaded.</p>

## 22.5 Update System Phones

In the **Maintenance->Update System Phones** menu, you can update your system telephone software.



### Note

Before beginning with the software update of your system telephone, you must load the software in the **Maintenance->Update System Phones->Firmware Files** menu on your SD card (if supported by your device) or in your system.

### 22.5.1 elmeg System Phones

In the **Maintenance->Update System Phones->elmeg System Phones** menu, you will see a list of the connected elmeg system telephones. You can select telephones for immediate updating of the software, or you can have the software updated on a scheduled basis.



In the case of immediate updating, there is no version control.

With time-controlled updating, a check is performed to determine whether a newer version of the system software is saved on the SD card or in your system than on the telephone. It's only in that case that an update takes place. The **Update by time** setting remains after the update has been received, i.e. within the configured period a daily check is performed to determine whether a newer version of the system software is available on the SD card or in your system.

### Values in the list **elmeg System Phones**

Field	Description
<b>Description</b>	Displays the description entered for the system telephone.
<b>Phone Type</b>	Displays the system telephone type.
<b>Serial Number</b>	Displays the system telephone serial number.
<b>System Version</b>	Displays the system telephone software version.
<b>SD Card Vers.</b>	Displays the inserted SD card version (if supported by you device) or the version stored in internal storage.
<b>Status/Update Status</b>	<p>Displays the system telephone status, or a progress bar during the update progress.</p> <ul style="list-style-type: none"> <li>✔ identifies a connected system telephone whose system software is supported by your PABX.</li> <li>✘ identifies a system telephone that is either not connected, or whose system software is not supported by your PABX.</li> <li>⌚ identifies an update currently not performed because the maximum number of possible simultaneous updating processes is momentarily exceeded. As soon as another updating process is complete, the telephone is updated in the ⌚ status.</li> </ul> <p>For IP telephone, there is no restriction on simultaneous updating of system software.</p> <p>With ISDN telephones, the number of simultaneous updates is dependent on system upgrades. Per digital module, two telephones can be simultaneously updated.</p>

Field	Description
	<p>If the system telephone system software is not supported by your PABX, there is still a way to update the system software.</p> <p>During system software updating, you see a progress bar.</p>
<b>Update by time</b>	<p>Displays whether, at a certain point, the system telephone software should be updated.</p> <p>This function is enabled on an individual device by setting a checkmark. The function is disabled by default.</p> <p>You can use the <b>Select all</b> and <b>Deselect all</b> buttons for all the devices displayed.</p>
<b>Update immediately</b>	<p>Displays whether the system telephone software should be updated immediately.</p> <p>This function is enabled on an individual device by setting a checkmark. The function is disabled by default.</p> <p>You can use the <b>Select all</b> and <b>Deselect all</b> buttons for all the devices displayed.</p>

## 22.5.2 elmeg OEM

In the **Maintenance->Update System Phones->elmeg OEM** menu, you will see a list of the connected elmeg OEM telephones or base stations. This view displays both elmeg IP1x telephones and elmeg DECT base stations, if there are any. You can select devices to have their software updated immediately or allow them to download completely new software from the system.

In the case of immediate updating, there is no version control.



### Note

Note that immediate software updates for DECT multi-cell systems are only available via the system's web configurator and that they cannot be initiated by the PABX GUI.

### Values in the list elmeg OEM

Field	Description
<b>Description</b>	Displays the description entered for the system telephone.
<b>Phone Type</b>	Displays the system telephone type.
<b>MAC Address</b>	Shows the system telephone's MAC address.
<b>Phone Version</b>	Displays the software version of the telephone.
<b>SD Card Vers.</b>	Displays the inserted SD card version (if supported by you device) or the version stored in internal storage .
<b>Status/Update Status</b>	<p>Displays the system telephone status, or a progress bar during the update progress.</p> <ul style="list-style-type: none"> <li><input checked="" type="checkbox"/> identifies a connected system telephone whose system software is supported by your PABX.</li> <li><input type="checkbox"/> identifies a system telephone that is either not connected, or whose system software is not supported by your PABX.</li> </ul> <p>For IP telephone, there is no restriction on simultaneous updating of system software.</p> <p>If the system telephone system software is not supported by your PABX, there is still a way to update the system software.</p> <p>During system software updating, you see a progress bar.</p>
<b>Update enabled</b>	<p>Shows whether connected telephones can independently download new software from the system.</p> <p>You can select individual entries using the checkbox in the corresponding line, or select them all using the <b>Select all</b> button or the <b>Deselect all</b> button.</p>
<b>Update immediately</b>	<p>Displays whether the system telephone software should be updated immediately.</p> <p>This function is enabled on an individual device by setting a checkmark. The function is disabled by default.</p> <p>You can use the <b>Select all</b> and <b>Deselect all</b> buttons for all the devices displayed.</p>

### 22.5.3 Firmware Files

In the **Maintenance->Update System Phones->Firmware Files** menu, you see the system software files that are currently available on your SD card (if supported by you device) or into the internal storage. You can load additional files on the SD card or into the internal storage.



#### Note

You will find current system software files in the download area, at [www.bintec-elmeg.com](http://www.bintec-elmeg.com).

For DECT systems there is a ZIP file available which contains the system software files and, for **elmeg DECT150**, language files too.



#### Note

One version of the system software file per telephone type can be saved on the SD card or into the internal storage.

#### Values in the list Firmware Files

Field	Description
<b>Load firmware</b>	Save the system software files on your SD card (if supported by you device) or into the internal storage.
<b>No.</b>	Displays the serial number of the system software file.
<b>Phone Type</b>	Displays the system telephone type.
<b>Version</b>	Displays the version of the system software.
<b>Status</b>	<input checked="" type="checkbox"/> indicates that a system software file is saved in the correct directory.

## 22.5.4 Settings

In the **Maintenance->Update System Phones->Settings** menu, you can set a period for the time-dependent updating of the system software. You can save a telephone number that may be used in case a system software update has failed. You can dial this number with the telephone in order to update the system software once the telephone is in boot mode following a failed update.

The **Maintenance->Update System Phones->Settings** menu consists of the following fields:

### Fields in the menu Time Settings for System Phone Firmware Update

Field	Description
<b>Internal Number</b>	<p>For ISDN system telephones only</p> <p>Enter the number of the PABX update server that you wish to call from the telephone if the system software update fails. In this case, you can perform the update from the telephone.</p> <p>This number is automatically sent to the system telephone when the telephone logs into the PABX.</p> <p>When it has been sent, the number is displayed on the telephone under <b>Menu-&gt;Service-&gt;Software Update</b>. If you press the <b>OK</b> button, the number is available in redial.</p>
<b>Firmware Update</b>	<p>Set a period for updating the system software. To do this, select the <b>Start Time</b> and the <b>Stop Time</b>.</p>

## 22.6 Reboot

### 22.6.1 System Reboot

In this menu, you can trigger an immediate reboot of your device. Once your system has restarted, you must call the **GUI** again and log in.

Pay attention to the LEDs on your device. For information on the meaning of the LEDs, see the **Technical Data** chapter of the manual.

**Note**

Before a reboot, make sure you confirm your configuration changes by clicking the **Save configuration** button, so that these are not lost when you reboot.

If you wish to restart your device, click the **OK** button. The device will reboot.

## 22.7 Factory Reset

In the menu **Maintenance->Factory Reset**, you can reset your device to the ex works state without having to have physical access to it.

## Chapter 23 External Reporting

In this system menu, you define what system protocol messages are saved on which computers, and whether the system administrator should receive an e-mail for certain events. Information on IP data traffic can also be saved--depending on the individual interfaces. In addition, SNMP traps can be sent to specific hosts in case of error.

### 23.1 Syslog

Events in various subsystems of your device (e.g. PPP) are logged in the form of syslog messages (system logging messages). The number of messages visible depends on the level set (eight steps from *Emergency* over *Information* to *Debug*).

In addition to the data logged internally on your device, all information can and should be transmitted to one or more external PCs for storage and processing, e.g. to the system administrator's PC. The syslog messages saved internally on your device are lost when you reboot.



#### Warning

Make sure you only pass syslog messages to a safe computer. Check the data regularly and ensure that there is always enough spare capacity available on the hard disk of your PC.

### Syslog Daemon

All Unix operating systems support the recording of syslog messages. For Windows PCs, the Syslog Daemon included in the **DIME Tools** can record the data and distribute to various files depending on the contents (can be called in the download area at [www.bintec-elmeg.com](http://www.bintec-elmeg.com)).

#### 23.1.1 Syslog Servers

Configure your device as a syslog server so that defined system messages can be sent to suitable hosts in the LAN.

In this menu, you define which messages are sent to which hosts and with which conditions.

A list of all configured system log servers displayed in the **External Reporting->Syslog->Syslog Servers** menu.

### 23.1.1.1 New

Select the **New** button to set up additional syslog servers.

The menu **External Reporting->Syslog->Syslog Servers->New** consists of the following fields:

#### Fields in the **Basic Parameters** menu.

Field	Description
<b>IP Address</b>	Enter the IP address of the host to which syslog messages are passed.
<b>Level</b>	<p>Select the priority of the syslog messages that are to be sent to the host.</p> <p>Possible values:</p> <ul style="list-style-type: none"> <li>• <i>Emergency</i> (highest priority)</li> <li>• <i>Alert</i></li> <li>• <i>Critical</i></li> <li>• <i>Error</i></li> <li>• <i>Warning</i></li> <li>• <i>Notice</i></li> <li>• <i>Information</i> (default value)</li> <li>• <i>Debug</i> (lowest priority)</li> </ul> <p>Syslog messages are only sent to the host if they have a higher or identical priority to that indicated, i.e. at syslog level <i>Debug</i> all messages generated are forwarded to the host.</p>
<b>Facility</b>	<p>Enter the syslog facility on the host.</p> <p>This is only required if the <b>Log Host</b> is a Unix computer.</p> <p>Possible values: <i>local0</i> - 7</p> <p>.</p> <p>The default value is <i>local0</i>.</p>



Field	Description
<b>Timestamp</b>	<p>Select the format of the time stamp in the syslog.</p> <p>Possible values:</p> <ul style="list-style-type: none"> <li>• <i>None</i> (default value): No system time indicated.</li> <li>• <i>Time</i>: System time without date.</li> <li>• <i>Date &amp;Time</i>: System time with date.</li> </ul>
<b>Protocol</b>	<p>Select the protocol for the transfer of syslog messages. Note that the syslog server must support the protocol.</p> <p>Possible values:</p> <ul style="list-style-type: none"> <li>• <i>UDP</i> (default value)</li> <li>• <i>TCP</i></li> </ul>
<b>Type of Messages</b>	<p>Select the message type.</p> <p>Possible values:</p> <ul style="list-style-type: none"> <li>• <i>System &amp;Accounting</i> (default value)</li> <li>• <i>System</i></li> <li>• <i>Accounting</i></li> </ul>

## 23.2 IP Accounting

In modern networks, information about the type and number of data packets sent and received over the network connections is often collected for commercial reasons. This information is extremely important for Internet Service Providers that bill their customers by data volume.

However, there are also non-commercial reasons for detailed network accounting. If, for example, you manage a server that provides different kinds of network services, it is useful for you to know how much data is generated by the individual services.

Your device contains the IP Accounting function, which enables you to collect a lot of useful information about the IP network traffic (each individual IP session).

### 23.2.1 Interfaces

In this menu, you can configure the IP Accounting function individually for each interface.

In the **External Reporting->IP Accounting->Interfaces** menu, a list of all interfaces configured on your device is shown. For each entry, you can activate IP Accounting by setting the checkmark. In the **IP Accounting** column, you do not need to click each entry individually. Using the options **Select all** or **Deselect all** you can enable or disable the IP accounting function for all interfaces simultaneously.

## 23.2.2 Options

In this menu, you configure general settings for IP Accounting.

In the **External Reporting->IP Accounting->Options** menu, you can define the **Log Format** of the IP accounting messages. The messages can contain character strings in any order, sequences separated by a slash, e.g. `\t` or `\n` or defined tags.

Possible format tags:

### Format tags for IP Accounting messages

Field	Description
%d	Date of the session start in the format DD.MM.YY
%t	Time of the session start in the format HH:MM:SS
%a	Duration of the session in seconds
%c	Protocol
%i	Source IP Address
%r	Source Port
%f	Source interface index
%l	Destination IP Address
%R	Destination Port
%F	Destination interface index
%p	Packets sent
%o	Octets sent
%P	Packets received
%O	Octets received
%s	Serial number for accounting message
%%	%

By default, the following format instructions are entered in the **Log Format** field: `INET:`

```
%d%t%a%c%i:%r/%f -> %I:%R/%F%p%o%P%O[%s]
```

## 23.3 Alert Service

It was previously possible to send syslog messages from the router to any syslog host. Depending on the configuration, e-mail alerts are sent to the administrator as soon as relevant syslog messages appear.

### 23.3.1 Alert Recipient

A list of Syslog messages is displayed in the **Alert Recipient** menu.

#### 23.3.1.1 New

Select the **New** to create additional alert recipients.

The menu **External Reporting->Alert Service->Alert Recipient->New** consists of the following fields:

#### Fields in the Add / Edit Alert Recipient menu.

Field	Description
<b>Alert Service</b>	<p>Displays the alert service. You can select an alert service for devices with UMTS.</p> <p>Possible values:</p> <ul style="list-style-type: none"> <li>• E-mail</li> <li>• SMS</li> </ul>
<b>Recipient</b>	<p>Enter the recipient's e-mail address. The entry is limited to 40 characters.</p>
<b>Message Compression</b>	<p>Select whether the text in the alert E-mail is to be shortened. The e-mail then contains the syslog message only once plus the number of relevant events.</p> <p>Enable or disable the field.</p> <p>The function is enabled by default.</p>
<b>Subject</b>	<p>You can enter a subject.</p>
<b>Event</b>	<p>This feature is available only for devices with Wireless LAN Controller.</p>

Field	Description
	<p>Select the event to trigger an email notification.</p> <p>Possible values:</p> <ul style="list-style-type: none"> <li>• <i>Syslog contains string</i> (default value): A Syslog message includes a specific string.</li> <li>• <i>New Neighbor AP found</i>: A new adjacent AP has been found.</li> <li>• <i>New Rogue AP found</i>: A new Rogue AP has been found, i.e. an AP using an SSID of its own network, yet is not a component of this network.</li> <li>• <i>New Slave AP (WTP) found</i>: A new unconfigured AP has reported to the WLAN.</li> <li>• <i>Managed AP offline</i>: A managed AP is no longer accessible.</li> </ul>
<b>Matching String</b>	<p>You must enter a "Matching String". This must occur in a syslog message as a necessary condition for triggering an alert.</p> <p>The entry is limited to 55 characters. Bear in mind that without the use of wildcards (e.g. "*"), only those strings that correspond exactly to the entry fulfil the condition. The "Matching String" entered therefore usually contains wildcards. To be informed of all syslog messages of the selected level, just enter "*".</p>
<b>Severity</b>	<p>Select the severity level which the string configured in the <b>Matching String</b> field must reach to trigger an e-mail alert.</p> <p>Possible values:</p> <p><i>Emergency</i> (default value), <i>Alert</i>, <i>Critical</i>, <i>Error</i>, <i>Warning</i>, <i>Notice</i>, <i>Information</i>, <i>Debug</i></p>
<b>Monitored Subsystems</b>	<p>Select the subsystems to be monitored.</p> <p>Add new subsystems with <b>Add</b>.</p>
<b>Message Timeout</b>	<p>Enter how long the router must wait after a relevant event before it is forced to send the alert mail.</p> <p>Possible values are 0 to 86400. The value 0 disables the timeout. The default value is 60.</p>

Field	Description
<b>Number of Messages</b>	<p>Enter the number of syslog messages that must be reached before an E-mail can be sent for this case. If timeout is configured, the mail is sent when this expires, even if the number of messages has not been reached.</p> <p>Possible values are <i>0</i> to <i>99</i>; the default value is <i>1</i>.</p>

### 23.3.2 Alert Settings

The menu **External Reporting->Alert Service->Alert Settings** consists of the following fields:

#### Fields in the **Basic Parameters** menu.

Field	Description
<b>Alert Service</b>	<p>Select whether the alert service is to be enabled for the interface.</p> <p>The function is enabled with <i>Enabled</i>.</p> <p>The function is enabled by default.</p>
<b>Maximum E-mails per Minute</b>	<p>Limit the number of outgoing mails per minute. Possible values are <i>1</i> to <i>15</i>, the default value is <i>6</i>.</p>

#### Fields in the **E-mail Parameters** menu.

Field	Description
<b>Sender E-mail Address</b>	<p>Enter the mail address to be entered in the sender field of the E-mail.</p>
<b>SMTP Server</b>	<p>Enter the address (IP address or valid DNS name) of the mail server to be used for sending the mails.</p> <p>The entry is limited to 40 characters.</p>
<b>SMTP Port</b>	<p>Encryption of e-mails (SSL / TLS).</p> <p>The field <b>SMTP Port</b> is per default preset to <i>25</i> and <b>SSL</b> Encryption is enabled.</p>
<b>SMTP Authentication</b>	<p>Authentication expected by the SMTP server.</p>

Field	Description
	<p>Possible values:</p> <ul style="list-style-type: none"> <li>• <i>None</i> (default value): The server accepts and send emails without further authentication.</li> <li>• <i>ESMTP</i>: The server only accepts e-mails if the router logs in with the correct user name and password.</li> <li>• <i>SMTP after POP</i>: The server requires that e-mails are called via POP3 by the sending IP with the correct POP3 user name and password before sending an e-mail.</li> </ul>
<b>User Name</b>	<p>Only if <b>SMTP Authentication</b> = <i>ESMTP</i> or <i>SMTP after POP</i></p> <p>Enter the user name for the POP3 or SMTP server.</p>
<b>Password</b>	<p>Only if <b>SMTP Authentication</b> = <i>ESMTP</i> or <i>SMTP after POP</i></p> <p>Enter the password of this user.</p>
<b>POP3 Server</b>	<p>Only if <b>SMTP Authentication</b> = <i>SMTP after POP</i></p> <p>Enter the address of the server from which the e-mails are to be retrieved.</p>
<b>POP3 Timeout</b>	<p>Only if <b>SMTP Authentication</b> = <i>SMTP after POP</i></p> <p>Enter how long the router must wait after the POP3 call before it is forced to send the alert mail.</p> <p>The default value is <i>600</i> seconds.</p>

#### Fields in the **SMS Parameters** menu (for devices with UMTS only)

Field	Description
<b>SMS Device</b>	<p>You can receive notification of system alerts in text messages. Select the device to be used to send the text message.</p>
<b>Maximum SMS per Day</b>	<p>Limit the maximum number of SMS sent during a single day.</p> <p>Activating <i>No Limitation</i> allows any number of SMS to be sent.</p> <p>The default value is 10 SMS per day.</p> <p>Note: Entering a value of <i>0</i> is equivalent to activating <i>No Limitation</i>.</p>

## 23.4 SNMP

SNMP (Simple Network Management Protocol) is a protocol from the IP protocol family for transporting management information about network components.

Every SNMP management system contains an MIB. SNMP can be used to configure, control and administrate various network components from one system. Such an SNMP tool is included on your device: the Configuration Manager. As SNMP is a standard protocol, you can use any other SNMP managers, e.g. HPOpenView.

For more information on the SNMP versions, see the relevant RFCs and drafts:

- SNMP V. 1: RFC 1157
- SNMP V. 2c: RFC 1901 - 1908
- SNMP V. 3: RFC 3410 - 3418

### 23.4.1 SNMP Trap Options

In the event of errors, a message - known as a trap packet - is sent unrequested to monitor the system.

In the **External Reporting->SNMP->SNMP Trap Options** menu, you can configure the sending of traps.

The menu **External Reporting->SNMP->SNMP Trap Options** consists of the following fields:

#### Fields in the **Basic Parameters** menu.

Field	Description
<b>SNMP Trap Broadcasting</b>	<p>Select whether the transfer of SNMP traps is to be activated.</p> <p>Your device then sends SNMP traps to the LAN's broadcast address.</p> <p>The function is activated by selecting <i>Enabled</i>.</p> <p>The function is disabled by default.</p>
<b>SNMP Trap UDP Port</b>	<p>Only if <b>SNMP Trap Broadcasting</b> is enabled.</p> <p>Enter the number of the UDP port to which your device is to send SNMP traps.</p>

Field	Description
	Any whole number is possible. The default value is <i>162</i> .
<b>SNMP Trap Community</b>	Only if <b>SNMP Trap Broadcasting</b> is enabled. Enter a new SNMP code. This must be sent by the SNMP Manager with every SNMP request so that this is accepted by your device. A character string of between <i>0</i> and <i>255</i> characters is possible. The default value is <i>SNMP Trap</i> .

## 23.4.2 SNMP Trap Hosts

In this menu, you specify the IP addresses to which your device is to send the SNMP traps.

In the **External Reporting->SNMP->SNMP Trap Hosts** menu, a list of all configured SNMP trap hosts is displayed.

### 23.4.2.1 New

Select the **New** button to create additional SNMP trap hosts.

The menu **External Reporting->SNMP->SNMP Trap Hosts->New** consists of the following fields:

**Fields in the Basic Parameters menu.**

Field	Description
<b>IP Address</b>	Enter the IP address of the SNMP trap host.

## 23.5 SIA



### 23.5.1 SIA

In the menu **External Reporting->SIA->SIA**, you can create and download a file that provides extensive support information about the status of your device like, e.g., the current configuration, available memory, uptime etc.

## Chapter 24 Monitoring

This menu contains information that enable you to locate problems in your network and monitor activities, e.g. at your device's WAN interface.

### 24.1 Status Information

This menu displays current settings for terminals and team subscribers. This data is continuously read out.

#### 24.1.1 Users

In the **Monitoring->Status Information->Users** menu, current settings for a user's internal number (MSN) are displayed.

##### 24.1.1.1 Users - Details

By pressing the  button, you display detailed statistics on the respective user.

##### Values in the Extension Status list

Field	Description
<b>Number</b>	Displays the user's internal number.
<b>Name</b>	Displays the name assigned to the user.  If a voicemail system is active, <i>Voice Mail System</i> is displayed.
<b>Current Class of Service</b>	Displays the all of the authorisation classes assigned to the user. The currently enabled authorisation class is marked appropriately with a green arrow (✔).
<b>Terminal</b>	Displays the interface assigned to this subscriber.
<b>Charges</b>	Displays calculated charges for accrued connection units.
<b>Status</b>	Displays the status of the interface to which the subscriber is connected.

##### Values in the System Settings list

Field	Description
<b>Parallel Ringing</b>	Displays whether parallel call is set up for the user.

Field	Description
<b>Call Forwarding</b>	Displays current call forwarding for this user.
<b>Do not Disturb</b>	Displays whether call waiting protection is set up for the user. (Only for system telephones)
<b>Call Waiting</b>	Displays whether call waiting is allowed for internal and/or external calls.
<b>Direct Call</b>	Displays whether direct call on receiver pickup is configured for the user.
<b>Room Monitoring</b>	Displays whether room monitoring is enabled for the user.
<b>Receive Announcement Calls</b>	Displays whether the announcement is allowed for the user.
<b>Receive Intercom Calls</b>	Displays whether simplex operation is allowed for the user.
<b>Automatic Call Pick-up</b>	Displays whether automatic call acceptance is configured for the user.

## 24.1.2 Teams

In the **Monitoring->Status Information->Teams** menu, current team settings are displayed.

### 24.1.2.1 Teams - Details

By pressing the  button, you display detailed statistics for the respective team.

#### Values in the Team Status list

Field	Description
<b>Name</b>	Displays the name assigned to the team.
<b>Number</b>	Displays the team's internal number.
<b>Users assigned/Users logged on</b>	Displays the users assigned to the team, and how many of these users are logged in.
<b>Call Forwarding</b>	Displays current call forwarding for this team.

#### Values in the System Settings list

Field	Description
<b>Active Variant (Day)</b>	Displays the currently enabled call option for this team.
<b>Switch call signalling</b>	Displays whether the call option can be switched manually, over the calendar or manually and over the calendar.
<b>Signalling</b>	Displays the type of call signalling in the team.

Field	Description
<b>Busy on busy</b>	Displays whether busy on busy is configured for the team.
<b>Automatic Call Pick-up</b>	Displays whether automatic call acceptance is configured, and which melody is played.
<b>Rerouting on no response</b>	Displays whether redirect on no reply is enabled and, if so, the time period after which it occurs and the destination team.
<b>Further Rerouting</b>	Displays which of the redirect functions are enabled and which subscriber is the redirect destination.

The menu **Advanced Settings** consists of the following fields:

#### Values in the **Advanced Settings** list

Field	Description
<b>Assigned Users</b>	Displays all logged-in and logged-out subscribers in the team.

## 24.2 Internal Log

### 24.2.1 System Messages

In the **Monitoring->Internal Log->System Messages** menu, a list of all internally stored system messages is displayed. Above the table you will find the configured values for the **Maximum Number of Syslog Entries** and **Maximum Message Level of Syslog Entries** fields. These values can be changed in the **System Management->Global Settings->System** menu.

#### Values in the **System Messages** list

Field	Description
<b>No.</b>	Displays the serial number of the system message.
<b>Date</b>	Displays the date of the record.
<b>Time</b>	Displays the time of the record.
<b>Level</b>	Displays the hierarchy level of the message.
<b>Subsystem</b>	Displays which subsystem of the device generated the message.
<b>Message</b>	Displays the message text.



## 24.3 IPSec

### 24.3.1 IPSec Tunnels

A list of all configured IPSec tunnel providers is displayed in the **Monitoring->IPSec->IPSec Tunnels** menu.

#### Values in the IPSec Tunnels list

Field	Description
<b>Description</b>	Displays the name of the IPSec tunnel.
<b>Remote IP</b>	Displays the IP address of the remote IPSec Peers.
<b>Remote Networks</b>	Displays the currently negotiated subnets of the remote terminal.
<b>Security Algorithm</b>	Displays the encryption algorithm of the IPSec tunnel.
<b>Status</b>	Displays the operating status of the IPSec tunnel.
<b>Action</b>	Enables you to change the status of the IPSec tunnel as displayed.
<b>Details</b>	Opens a detailed statistics window.

You change the status of the IPSec tunnel by clicking the  button or the  button in the **Action** column.

By clicking the  button, you display detailed statistics on the IPSec connection.

#### Values in the IPSec Tunnels list

Field	Description
<b>Description</b>	Shows the description of the peer.
<b>Local IP Address</b>	Shows the WAN IP address of your device.
<b>Remote IP Address</b>	Shows the WAN IP address of the connection partner.
<b>Local ID</b>	Shows the ID of your device for this IPSec tunnel.
<b>Remote ID</b>	Shows the ID of the peer.
<b>Negotiation Type</b>	Shows the exchange type.
<b>Authentication Method</b>	Shows the authentication method.
<b>MTU</b>	Shows the current MTU (Maximum Transfer Unit).
<b>Alive Check</b>	Shows the method for checking that the peer is reachable.
<b>NAT Detection</b>	Displays the NAT detection method.
<b>Local Port</b>	Shows the local port.

Field	Description
<b>Remote Port</b>	Shows the remote port.
<b>Packets</b>	Shows the total number of incoming and outgoing packets.
<b>Bytes</b>	Shows the total number of incoming and outgoing bytes.
<b>Errors</b>	Shows the total number of errors.
<b>IKE (Phase-1) SAs (x)</b> <b>Role / Algorithm / Lifetime remaining / Status</b>	The parameters of the IKE (Phase 1) SAs are displayed here.
<b>IPSec (Phase-2) SAs (x)</b> <b>Role / Algorithm / Lifetime remaining / Status</b>	Shows the parameters of the IPSec (Phase 2) SAs.
<b>Messages</b>	The system messages for this IPSec tunnel are displayed here.

### 24.3.2 IPSec Statistics

In the **Monitoring->IPSec->IPSec Statistics** menu, statistical values for all IPSec connections are displayed.

The **Monitoring->IPSec->IPSec Statistics** menu consists of the following fields:

#### Fields in the Licences menu

Field	Description
<b>IPSec Tunnels</b>	Shows the IPSec licences currently in use ( <b>In Use</b> ) and the maximum number of licenses usable ( <b>Maximum</b> ).

#### Fields in the Peers menu

Field	Description
<b>Status</b>	Displays the number of IPSec tunnels by their current status. <ul style="list-style-type: none"> <li>• <b>Up</b>: Currently active IPSec tunnels.</li> <li>• <b>Going up</b>: IPSec tunnels currently in the tunnel setup phase.</li> <li>• <b>Blocked</b>: IPSec tunnels that are blocked.</li> <li>• <b>Dormant</b>: Currently inactive IPSec tunnels.</li> <li>• <b>Configured</b>: Configured IPSec tunnels.</li> </ul>

**Fields in the SAs menu.**

Field	Description
<b>IKE (Phase-1)</b>	Shows the number of active phase 1 SAs ( <b>Established</b> ) from the total number of phase 1 SAs ( <b>Total</b> ).
<b>IPSec (Phase-2)</b>	Shows the number of active phase 2 SAs ( <b>Established</b> ) from the total number of phase 2 SAs ( <b>Total</b> ).

**Fields in the Packet Statistics menu.**



Field	Description
<b>Total</b>	Shows the number of all processed incoming ( <b>In</b> ) or outgoing ( <b>Out</b> ) packets.
<b>Passed</b>	Shows the number of incoming ( <b>In</b> ) or outgoing ( <b>Out</b> ) packets forwarded in plain text.
<b>Dropped</b>	Shows the number of all rejected incoming ( <b>In</b> ) or outgoing ( <b>Out</b> ) packets.
<b>Encrypted</b>	Shows the number of all incoming ( <b>In</b> ) or outgoing ( <b>Out</b> ) packets protected by IPSec.
<b>Errors</b>	Shows the number of incoming ( <b>In</b> ) or outgoing ( <b>Out</b> ) packets for which processing led to errors.

## 24.4 Interfaces

### 24.4.1 Statistics

In the **Monitoring->Interfaces->Statistics** menu, current values and activities of all device interfaces are displayed.

With the filter bar, you can select whether to display **Transfer Totals** or **Transfer Throughput**. The values per second are shown on the **Transfer Throughput** display.

Change the status of the interface by clicking the  or the  button in the **Action** column.

**Values in the Statistics list**

Field	Description
<b>No.</b>	Shows the serial number of the interface.
<b>Description</b>	Displays the name of the interface.
<b>Type</b>	Displays the interface text.
<b>Tx Packets</b>	Shows the total number of packets sent.

Field	Description
<b>Tx Bytes</b>	Displays the total number of octets sent.
<b>Tx Errors</b>	Shows the total number of errors sent.
<b>Rx Packets</b>	Shows the total number of packets received.
<b>Rx Bytes</b>	Displays the total number of bytes received.
<b>Rx Errors</b>	Shows the total number of errors received.
<b>Status</b>	Shows the operating status of the selected interface.
<b>Unchanged for</b>	Shows the length of time for which the operating status of the interface has not changed.
<b>Action</b>	Enables you to change the status of the interface as displayed.

Click the  button to display the statistical data for the individual interfaces in detail.

#### Values in the Statistics list

Field	Description
<b>Description</b>	Displays the name of the interface.
<b>MAC Address</b>	Displays the interface text.
<b>IP Address / Netmask</b>	Shows the IP address and the netmask.
<b>NAT</b>	Indicates if NAT is activated for this interface.
<b>Tx Packets</b>	Shows the total number of packets sent.
<b>Tx Bytes</b>	Displays the total number of octets sent.
<b>Rx Packets</b>	Shows the total number of packets received.
<b>Rx Bytes</b>	Displays the total number of bytes received.

#### Fields in the TCP Connections menu

Field	Description
<b>Status</b>	Displays the status of an active TCP connection.
<b>Local Address</b>	Displays the local IP address of the interface for an active TCP connection.
<b>Local Port</b>	Displays the local port of the IP address for an active TCP connection.
<b>Remote Address</b>	Displays the IP address to which an active TCP connection exists.
<b>Remote Port</b>	Displays the port to which an active TCP connection exists.



## 24.4.2 Network Status

The menu **Monitoring->Interfaces->Network Status** provides an overview of all IP interfaces currently configured on the device. You can find information on the status of an interface as well as on relevant parameters like its IPv4 and/or IPv6 IP address, the MAC address of the interface and the currently valid MTU.

## 24.5 WLAN

### 24.5.1 WLANx

In the **Monitoring->WLAN->WLAN** menu, current values and activities of the WLAN interface are displayed. The values for wireless mode 802.11n are listed separately.

#### Values in the WLAN list

Field	Description
<b>mbps</b>	Displays the possible data rates on this wireless module.
<b>Tx Packets</b>	Shows the total number of packets sent for the data rate shown in <b>mbps</b> .
<b>Rx Packets</b>	Shows the total number of received packets for the data rate shown in <b>mbps</b> .

You can choose the **Advanced** button to go to an overview of more details.

#### Values in the Advanced list

Field	Description
<b>Description</b>	Displays the description of the displayed value.
<b>Value</b>	Displays the statistical value.

#### Meaning of the list entries

Description	Meaning
<b>Unicast MSDUs transmitted successfully</b>	Displays the number of MSDUs successfully sent to unicast addresses since the last reset. An acknowledgement was received for each of these packets.
<b>Multicast MSDUs transmitted successfully</b>	Displays the number of MSDUs successfully sent to multicast addresses (including the broadcast MAC address).



Description	Meaning
<b>Transmitted MPDUs</b>	Displays the number of MPDUs received successfully.
<b>Multicast MSDUs received successfully</b>	Displays the number of successfully received MSDUs that were sent with a multicast address.
<b>Unicast MPDUs received successfully</b>	Displays the number of successfully received MSDUs that were sent with a unicast address.
<b>MSDUs that could not be transmitted</b>	Displays the number of MSDUs that could not be sent.
<b>Frame transmissions without ACK received</b>	Displays the number of sent frames for which an acknowledgment frame was not received.
<b>Duplicate received MSDUs</b>	Displays the number of MSDUs received in duplicate.
<b>CTS frames received in response to an RTS</b>	Displays the number of received CTS (clear to send) frames that were received as a response to RTS (request to send).
<b>Received MPDUs that couldn't be decrypted</b>	Displays the number of received MSDUs that could not be encrypted. One reason for this could be that a suitable key was not entered.
<b>RTS frames with no CTS received</b>	Displays the number of RTS frames for which no CTS was received.
<b>Corrupt Frames Received</b>	Displays the number of frames received incompletely or with errors.

## 24.5.2 VSS

In the **Monitoring->WLAN->VSS** menu, current values and activities of the configured wireless networks are displayed.

### Values in the VSS list

Field	Description
<b>MAC Address</b>	Shows the MAC address of the associated client.
<b>IP Address</b>	Shows the IP address of the client.
<b>Uptime</b>	Shows the time in hours, minutes and seconds for which the client is logged in.
<b>Tx Packets</b>	Shows the total number of packets sent.
<b>Rx Packets</b>	Shows the total number of packets received.
<b>Signal dBm (RSSI1, RSSI2, RSSI3)</b>	Shows the received signal strength in dBm.

Field	Description
Noise dBm	Shows the received noise strength in dBm.
Data Rate mbps	Shows the current transmission rate of data received by this client in mbps.  The following clock rates are possible: IEEE 802.11b: 11, 5.5, 2 and 1 mbps; IEEE 802.11g/a: 54, 48, 36, 24, 18, 12, 9, 6 mbps.  If the 5 GHz frequency band is used, the indication of 11, 5.5, 2 and 1 mbps is suppressed for IEEE 802.11b.
Rx Discards	Displays the number of received data packets that have been discarded if the bandwidth for receive traffic has been limited in the <b>Wireless LAN-&gt;WLAN-&gt;Wireless Networks (VSS)-&gt;</b>  menu using the field <b>Rx Shaping</b>
Tx Discards	Displays the number of data packets that were queued for transmission and have been discarded if the bandwidth for transmit traffic has been limited in the <b>Wireless LAN-&gt;WLAN-&gt;Wireless Networks (VSS)-&gt;</b>  menu using the field <b>Rx Shaping</b> .

### VSS - Details for Connected Clients

In the **Monitoring->WLAN->VSS-><Connected Client>** ->  menu, the current values and activities of a connected client are shown. The values for wireless mode 802.11n are listed separately.

#### Values in the list <Connected Client>

Field	Description
Client MAC Address	Shows the MAC address of the associated client.
IP Address	Shows the IP address of the client.
Uptime	Shows the time in hours, minutes and seconds for which the client is logged in.
Signal dBm(RSSI1, RSSI2, RSSI3)	Shows the received signal strength in dBm.
Noise dBm	Shows the received noise strength in dBm.
SNR dB	Signal-to-Noise Ratio in dB is an indicator of the quality of the wireless connection.  Values:

Field	Description
	<ul style="list-style-type: none"> <li>• &gt; 25 dB excellent</li> <li>• 15 – 25 dB good</li> <li>• 2 – 15 dB borderline</li> <li>• 0 – 2 dB bad.</li> </ul>
<b>Data Rate mbps</b>	Shows the current transmission rate of data received by this client in mbps. The following clock rates are possible: IEEE 802.11b: 11, 5.5, 2 and 1 mbps; IEEE 802.11g/a: 54, 48, 36, 24, 18, 12, 9.6 Mbps. If the 5-GHz frequency band is used, the indication of 11, 5.5, 2 and 1 Mbps is suppressed for IEEE 802.11b.
<b>Rate</b>	Displays the possible data rates on the wireless module.
<b>Tx Packets</b>	Shows the number of sent packets for the data rate.
<b>Rx Packets</b>	Shows the number of received packets for the data rate.

### 24.5.3 Client Management

The **Monitoring->WLAN->Client Management** menu displays an overview of the **Client Management**. For each VSS you can see such information as the number of clients connected, the number of clients that are affected by the **2,4/5 GHz changeover**, and the number of rejected clients.

#### Values in the list Client Management

Field	Description
<b>VSS Description</b>	Displays the unique description of the wireless network (VSS).
<b>Network Name (SSID)</b>	Displays the name of the wireless network (SSID).
<b>MAC Address</b>	Displays the MAC address being used for this VSS.
<b>Active Clients</b>	Displays the number of active clients.
<b>2,4/5 GHz changeover</b>	Displays the number of clients who have been moved to a different frequency band by the <b>2,4/5 GHz changeover</b> function.
<b>Denied Clients soft/hard</b>	Displays the number of rejected clients after the absolute number of permitted clients has been reached.

### 24.5.4 Bridge Links

In the **Monitoring->WLAN->Bridge Links** menu, current values and activities of the bridge links are displayed.

**Values in the Bridge Links list**

Field	Description
<b>Bridge Link Description</b>	Shows the name of the bridge link.
<b>Remote MAC</b>	Shows the MAC address of the bridge link partner.
<b>First seen</b>	Displays the time of the first registered attempted contact of the bridge link partner.
<b>Last seen</b>	Displays the time of the last registered attempted contact of the bridge link partner.
<b>Tx Packets</b>	Shows the total number of packets sent.
<b>Rx Packets</b>	Shows the total number of packets received.
<b>Signal dBm (RSSI1, RSSI2, RSSI3)</b>	Shows the received signal strength in dBm.
<b>Noise dBm</b>	Shows the received noise strength in dBm.
<b>Tx Data Rate mbps</b>	Shows the current clock rate of data sent on this bridge link in Mbps.
<b>Rx Data Rate mbps</b>	Shows the current clock rate of data received on this bridge link in Mbps.
<b>Uptime</b>	Shows the time in hours, minutes and seconds for which the bridge link in question is active.

**Bridge link details**

You can use the  icon to open an overview of further details of the bridge links.

**Values in the Bridge Links list**

Field	Description
<b>Bridge Link Description</b>	Shows the name of the bridge link.
<b>Remote MAC</b>	Shows the MAC address of the bridge link partner.
<b>First seen</b>	Displays the time of the first registered attempted contact of the bridge link partner.
<b>Last seen</b>	Displays the time of the last registered attempted contact of the bridge link partner.
<b>Signal dBm (RSSI1, RSSI2, RSSI3)</b>	Shows the received signal strength in dBm.

Field	Description
Noise dBm	Shows the received noise strength in dBm.
Tx Data Rate mbps	Shows the current clock rate of data sent on this bridge link in Mbps.
Rx Data Rate mbps	Shows the current clock rate of data received on this bridge link in Mbps.
Rate	For each of the specified data rates, displays the values for <b>Tx Packets</b> and <b>Rx Packets</b> .
Tx Packets	Shows the total number of packets sent.
Rx Packets	Shows the total number of packets received.

## 24.6 Bridges

### 24.6.1 br<x>

In the **Monitoring->Bridges->br<x>** menu, the current values of the configured bridges are shown.

Values in the **br<x>** list

Field	Description
MAC Address	Shows the MAC addresses of the associated bridge.
Port	Shows the port on which the bridge is active.

## 24.7 HotSpot Gateway

### 24.7.1 HotSpot Gateway

A list of all linked hotspot users is displayed in the **Monitoring->HotSpot Gateway->HotSpot Gateway** menu.

Values in the **HotSpot Gateway** list

Field	Description
User Name	Displays the user's name.
IP Address	Shows the IP address of the user.

Field	Description
<b>Physical Address</b>	Shows the physical address of the user.
<b>Logon</b>	Displays the time of the notification.
<b>Interface</b>	Shows the interface used.

## 24.8 QoS

In the **Monitoring->QoS** menu, statistics are displayed for interfaces on which QoS has been configured.

### 24.8.1 QoS

A list of all interfaces for which QoS was configured is displayed in the **Monitoring->QoS->QoS** menu.

#### Values in the QoS list

Field	Description
<b>Interface</b>	Shows the interface for which QoS has been configured.
<b>QoS Queue</b>	Shows the QoS queue, which has been configured for this interface.
<b>Send</b>	Shows the number of sent packets with the corresponding packet class.
<b>Dropped</b>	Shows the number of rejected packets with the corresponding packet class in case of overloading.
<b>Queued</b>	Shows the number of waiting packets with the corresponding packet class in case of overloading.

## Chapter 25 User Access

The system administrator can set up an individual configuration access interface for the users. You, the user, can thus display your most important personal settings and individually customise some of these.

To log in to the configuration interface with your assigned access data, enter your **User Name** and **Password** in the login window.

After successful login, the **Status** page is displayed. It includes an overview of your most important settings.

In the **Phonebook** menu, you can access the **System Phonebook** and create, edit as well as delete entries in a user-specific telephone book.

In the **Call Data Records** menu, you get a detailed overview of the calls you have conducted and accepted.

The **Settings** menu contains an overview of current settings of performance features **Direct Call**, **Call Forwarding** and **Parallel Ringing**. You can individually customise these here. In addition, you can view general settings and customise access and contact data.

You can also view the settings of the **elmeg System Phones** assigned to you, and modify these to your needs.

In the **Voice Mail System ->Settings** menu, you'll see the current configuration of your individual voicemail box, as well as the number of messages present. You can modify several frequently used voicemail box parameters here. The **Voice Mail System ->Messages** menu displays a detailed overview of all received calls.

### 25.1 Status

The **User Access->Status** menu displays the most important settings performed for you by the system administrator.

The **User Access->Status** menu consists of the following fields:

#### Values in the User Data list

Field	Description
<b>Name, First Name</b>	Displays the configured surname and name, if applicable, of your user.



Field	Description
<b>Description</b>	Displays the configured additional description for your user.

#### Values in the **Internal Numbers & Communication Cost** list

Field	Description
<Internal Number>	Displays the connection charges for the internal numbers assigned to your user.

#### Values in the **Further Settings** list

Field	Description
<b>Current Class of Service</b>	Displays the name of the authorisation class to which your user is assigned.
<b>Dialling Authorization</b>	<p>Displays the dial permission for your telephones. This derives from the setting for the corresponding user class.</p> <p>Possible values:</p> <ul style="list-style-type: none"> <li>• <i>International</i>: The telephones have unrestricted dialling authorisations and can initiate all connections.</li> <li>• <i>National</i>: The telephones can initiate all calls except international calls. If a number starts with the code for international dialling, the number cannot be dialled.</li> <li>• <i>Incoming</i>: The telephones can receive incoming external calls, but cannot initiate any external calls. Internal calls are possible.</li> <li>• <i>Region</i>: The telephones cannot make any national or international calls. For this dial permission, 10 exception numbers allowing national or international dialling can be configured. An exception number can consist of complete call numbers or sections thereof (e. g. the first numerals).</li> <li>• <i>Local</i>: The telephones can make local calls. National and international calls are not possible.</li> <li>• <i>Internal</i>: The telephones do not have authorisation for incoming or outgoing external calls. Only internal telephone calls are possible.</li> </ul>
<b>Allow manual trunk group selection</b>	Indicates whether your user is assigned to an authorisation class for which manual bundle assignment is allowed. If so, authorised bundles or external connections are displayed.

Field	Description
	<p>Besides general exchange access, a telephone can also selectively use a bundle. Here an external connection is initiated with the corresponding code for the target assignment of the bundle and not by dialling the dialling code.</p> <p>To be able to perform a selective bundle assignment, the authorisation class must possess the appropriate authorisation. The authorisation can also include bundles that the authorisation class can otherwise not assign. If a telephone does not possess the authorisation for selective bundle assignment, or if the selected bundle is in use, the busy tone is heard after dialling the code. If <b>Automatic Outside Line</b> is set up for an authorisation class, users of this authorisation class must press the star key before selective bundle assignment, then initiate external dialling with the code for bundle assignment.</p>
<b>Pick-up Group</b>	Displays the number of the group in which calls may be picked up.

## 25.2 Phonebook

In the **Phonebook** menu, telephone book entries are displayed separately according to **System Phonebook** and **User Phonebook**. In **User Phonebook** the user can create, modify or delete up to 50 own entries. These entries can only be viewed by the respective user. These entries are updated via the **GUI**.

### 25.2.1 System Phonebook

In the **System Phonebook**, entries of the overall system created by the administrators are displayed. You cannot modify these.

#### Values in the System telephone book list

Field	Description
<b>Description</b>	Displays the subscriber's description. The <b>System Phonebook</b> is sorted according to these entries.
<b>Phone Number</b>	Displays the telephone number.
<b>Speed Dial Number</b>	Displays the speed-dial number.

Field	Description
<b>Call Through</b>	Indicates whether the telephone number for the <b>Call Through</b> function is activated.

## 25.2.2 User Phonebook

In the **User Phonebook**, your user entries are displayed. You can add, edit or delete entries.

### 25.2.2.1 Edit or New

Choose the  icon to edit existing entries. Select the **New** button to create new entries.

The menu **User Access->Phonebook->User Phonebook->New** consists of the following fields:

#### Fields in the Phonebook Entry menu.

Field	Description
<b>Description</b>	Enter a description for the entry. Sorting in <b>User Phonebook</b> follows the initial letters of the entry.
<b>Phone Number</b>	Enter the telephone number (internal or external).

## 25.3 Call Data Records

The **Call Data Records** menu displays your user's incoming and outgoing connections recorded to date.

### 25.3.1 Outgoing

The **Call Data Records->Outgoing** menu consists of the following fields:

#### Values in the Outgoing list

Field	Description
<b>Date</b>	Displays the connection date.
<b>Time</b>	Displays the time at call start.

Field	Description
<b>Duration</b>	Displays the duration of the connection.
<b>User</b>	Displays the user who called.
<b>Int. No.</b>	Displays the user's internal number.
<b>Called Number</b>	Displays the dialled number.
<b>Project Code</b>	Displays the call project number, if any.
<b>Interface</b>	Displays the interface over which the external connection was routed.
<b>Costs</b>	Displays the connection charge, but only if the provider transmits the corresponding data.

## 25.3.2 Incoming

The **Call Data Records->Incoming** menu consists of the following fields:

### Values in the Incoming list

Field	Description
<b>Date</b>	Displays the connection date.
<b>Time</b>	Displays the time at call start.
<b>Duration</b>	Displays the duration of the connection.
<b>User</b>	Displays the user who was called.
<b>Int. No.</b>	Displays the user's internal number.
<b>External Number</b>	Displays the caller's number.
<b>Project Code</b>	Displays the call project number, if any.
<b>Interface</b>	Displays the interface over which the connection from outside was routed.

## 25.4 Settings

In the **Settings** menu, you can perform personal settings to performance features direct call, call forwarding (CF), parallel call and do not disturb, as well as customise general settings.

### 25.4.1 Feature Settings

In the **Settings->Feature Settings** menu, the settings for performance features direct call, call forwarding (CF), parallel call and do not disturb can be customised.

#### 25.4.1.1 Call Forwarding

In the **Settings->Feature Settings->Call Forwarding** menu, you configure forwarding of incoming calls to your internal number onto the entered destination number.

You are temporarily away from your office, but don't want to miss a call. With call forwarding to another number, e.g. your mobile, you can receive your calls even when you are not at your desk. You can forward calls on your number to any call number. It can occur *Immediately*, *On no reply* or *On Busy*. Call forwarding *On no reply* and *On Busy* can exist concurrently. If you are not near your telephone, for example, the call is forwarded to another number (e.g. your mobile phone) after a short period. If you are making a call at your desk, other caller may receive the busy signal. You can forward these callers e.g. to a colleague or the secretary by using call forwarding on busy.

Calls can be forwarded to internal subscriber numbers, internal team numbers or external numbers. When the number to which calls shall be forwarded is entered, the system automatically checks whether it's an internal or external number.

To continue with configuring, click the  symbol.

Select the  button to go to the **IP1x0** telephone user interface administrator page. This is described in the telephone user guide!

The **Settings->Feature Settings->Call Forwarding** menu consists of the following fields:

#### Fields in the Call Forwarding menu.

Field	Description
<b>Active Function</b>	Select whether to enable the call forwarding (CF) function for your telephone.  The function is enabled with <i>Enabled</i>

Field	Description
	The function is disabled by default.
<b>Type</b>	Select when incoming calls shall be forwarded to the specified internal number.  Possible values: <ul style="list-style-type: none"> <li>• <i>Immediately</i></li> <li>• <i>On Busy</i></li> <li>• <i>On no reply</i> (default value)</li> <li>• <i>On busy / On no reply</i></li> </ul>
<b>Destination on no Reply</b>	Enter the number to which incoming calls shall be forwarded after time.
<b>Destination on Busy</b>	Enter the number to which incoming calls shall be forwarded on busy.
<b>Destination immediately</b>	Enter the number to which incoming calls shall be forwarded immediately.

### 25.4.1.2 Parallel Ringing

In the **Settings->Feature Settings->Parallel Ringing** menu, you configure which calls should be signalled to your terminal.

The **Settings->Feature Settings->Parallel Ringing** menu consists of the following fields:

#### Fields in the Parallel Ringing menu.

Field	Description
<b>Active Function</b>	Select whether to enable the parallel call function for your telephone.  The function is enabled with <i>Enabled</i>  The function is disabled by default.
<b>External Number</b>	Under <i>Individual Number</i> enter the external telephone number to which a call should be signalled in parallel. If a mobile number and a call number are configured for personal use, these are displayed in <i>Configured Home Number</i> or <i>Con-</i>

Field	Description
	<i>figured Mobile Number</i> and can be selected.

### 25.4.1.3 Direct Call

You wish to install your telephone in such a way that connection to a specific call number is set up even without entry of the number (e. g. emergency phone). You are not at home. However, there is someone at home who needs to be able to reach you quickly and easily by telephone if necessary (e. g. children or grandparents). If you have set up the Direct Call function for your telephone, the telephone receiver only needs to be picked up. After a time period without further entries set in configuration, the system automatically dials the configured direct call number.

If you do not dial within the specified period from picking up the receiver, automatic dialling is initiated.

The **Settings->Feature Settings->Direct Call** menu consists of the following fields:

#### Fields in the Direct Call menu.

Field	Description
<b>Active Function</b>	<p>Select whether to enable the direct call function for your telephone.</p> <p>The function is enabled with <i>Enabled</i></p> <p>The function is disabled by default.</p>
<b>Number</b>	<p>Select which number to use for direct call.</p> <p>Possible values:</p> <ul style="list-style-type: none"> <li>• <i>Preconfigured Number</i>: Select the desired number for which to set up direct call from the dropdown list.</li> <li>• <i>Individual Number</i>: Enter the desired number for which to set up direct call into the input field.</li> </ul>

### 25.4.1.4 Do not Disturb

You can use the "station guarding" (do not disturb) feature to configure which calls will be signalled to your terminal.

The **Settings->Feature Settings->Do not Disturb** menu consists of the following fields:

**Fields in the menu Do not Disturb**

Field	Description
<b>Active Function</b>	<p>Select whether to enable the "station guarding" function for your telephone.</p> <p>The function is enabled with <i>Enabled</i>.</p> <p>The function is disabled by default.</p>
<b>Do not Disturb</b>	<p>With the station guarding feature, you can enable call signalling to your terminal. Analogue terminals use system code numbers for this.</p> <p>Select the calls for which you wish to use the feature.</p> <p>Possible values:</p> <ul style="list-style-type: none"> <li>• <i>Internal Calls not signaled</i></li> <li>• <i>External Calls not signaled</i></li> <li>• <i>No Calls signaled</i></li> </ul>

**25.4.1.5 Log on / Log off**

With system telephones, it is only possible to log out of a team using the **Log on / Log off** function key. The team administrator must run this function manually if standard telephones are used.

The **Settings->Feature Settings->Log on / Log off** menu consists of the following fields:

**Fields in the menu Log on / Log off**

Field	Description
<b>Description</b>	Shows which teams the user belongs to.
<b>Status</b>	<p>Select whether the team member shall be logged in or out of the team.</p> <p>The function is activated by selecting <i>Logged on</i>.</p> <p>The function is enabled by default.</p>



## 25.4.2 General Settings

Your user's most important settings are listed in the **Settings->General Settings** menu. Personal access data (configuration password, IP phone password) as well as mobile and home office numbers can be customised.

The menu **Settings->General Settings** consists of the following fields:

### Fields in the User Data menu.

Field	Description
<b>Name</b>	Displays your user's name.
<b>Description</b>	Displays the additional description for your user.
<b>Login Name</b>	Displays your user name for login to the user configuration interface.
<b>Password for HTML Configuration Access</b>	If you wish to change your password for access to the user configuration interface, enter a new password here. To check, you can display the password in plain text by clicking the <b>Show</b> option.
<b>Password for IP Phone Registration</b>	If you wish to change your password for IP telephone login, enter a new password here. To check, you can display the password in plain text by clicking the <b>Show</b> option.
<b>PIN for Phone Access</b>	If you wish to change the PIN for your personal voicebox, enter a new PIN here. To check, you can display the password in plain text by clicking the <b>Show</b> option.
<b>Mobile Number</b>	Here, you can enter the mobile number under which you can be reached.
<b>Home Office Number</b>	Here, you can enter the home office number under which you can be reached.
<b>Busy on busy</b>	Indicates whether performance feature Busy on Busy is enabled for the currently selected user.  If a subscriber for whom multiple telephone numbers have been configured makes a call, you can decide whether additional

Field	Description
	<p>calls for this user shall be signalled. If "Busy on Busy" is set for this user, other callers get an <b>Engaged</b> signal if the user is calling on one of her numbers.</p> <p>The function is activated by selecting <i>Enabled</i>.</p> <p>The function is disabled by default.</p>

#### Fields in the **Status Information** menu.

Field	Description
<b>Extension Numbers</b>	Displays the internal numbers assigned to you.
<b>Current Class of Service</b>	Displays the authorisation class to which you're currently assigned.
<b>Dialling Authorization</b>	Displays your dial permission.
<b>Allow manual trunk group selection</b>	Displays whether you're allowed to assign additional bundles to outside lines and, if so, which.
<b>Pick-up Group</b>	Displays the number of the group in which calls may be picked up.

## 25.5 Assigned elmeg Phones

The **Assigned elmeg Phones** menu shows the telephones that the system administrator has assigned to you.





### Note

The **Assigned elmeg Phones** menu is only displayed if you've already been assigned system telephones by the administrator.

### 25.5.1 Assigned elmeg Phones

The **Assigned elmeg Phones**->**Assigned elmeg Phones** menu shows a list with the key information about your telephone. The  symbol takes you to the **IP1x0** phone's configuration interface.

Select the  symbol to reset the phone's user password.

The **Assigned elmeg Phones->Assigned elmeg Phones**  menu consists of the following fields:

#### Fields in the System Phone menu

Field	Description
<b>User password</b>	<p>Select whether the user password should be reset.</p> <p>The function is activated by selecting <i>Enabled</i>.</p> <p>The function is disabled by default.</p> <p>As soon as you select the <b>OK</b> button, the password is reset to the default setting.</p>

## 25.6 elmeg System Phones

The menu **elmeg System Phones** displays the system telephones assigned to you by the system administrator.



### Note

The **elmeg System Phones** menu is only displayed if you've already been assigned system telephones by the administrator.

### 25.6.1 Assigned System Phones

The system telephone offers typical system performance features associated with bintec elmeg systems. For example:

- Dialling from the system phone book
- Announcement and simplex operation with other system telephones on the system
- Function keys for control of system performance features (enable call options, login/logout in teams, line keys, connection keys). The status of defined performance features can be indicated via LED's assigned to individual function keys.

**Note**

Configuration modifications are transmitted to the system telephones at the earliest 30 seconds after confirming the modification with the **Apply** button.

**25.6.1.1 Settings**

In the **elmeg System Phones->Assigned System Phones->Settings** you can release specific performance features and functions for your system telephone.

The **elmeg System Phones->Assigned System Phones->Settings** menu consists of the following fields:

**Fields in the menu Basic Settings**

Field	Description
<b>Headset Support</b>	<p>Not for <b>S530</b> and <b>S560</b>.</p> <p>Select whether the headset should automatically accept calls.</p>
	<div data-bbox="539 901 619 951" data-label="Image"></div> <p><b>Note</b></p> <p>If you wish to use a headset, you must configure a headset key and a key for automatic call acceptance on your PABX system. On the system telephone, you must select a headset type and enable the key for automatic call acceptance.</p>

Field	Description
	<p>Under <b>Repeat Call Waiting Signal</b>, also decide whether the call waiting tone or the display notification should only be signalled once, or repeated.</p>
<b>Do not Disturb</b>	<p>Only for telephones in the <b>CS4xx</b> series, the <b>S530</b> telephones and <b>S560</b> and the <b>IP-S400</b> telephone.</p> <p>For the <b>S530</b> and <b>S560</b> telephones, you merely configure the function here. With these telephones, enable <i>Do not Disturb</i> via the function key.</p> <p>Select whether you wish to use the call protection (do not disturb) performance feature.</p> <p>With this performance feature, you can enable call signalling to your terminal.</p> <p>Select for which number you wish to use the station guarding performance feature.</p> <p>Possible values:</p> <ul style="list-style-type: none"> <li>• <i>First Number only</i> (<b>CS4xx</b> series only): Call protection applies only to the first configured MSN.</li> <li>• <i>All Numbers</i> (<b>CS4xx</b> series only): Call protection applies to all configured MSN's.</li> </ul> <p>Select whether incoming calls shall be signalled:</p> <ul style="list-style-type: none"> <li>• <i>Off</i>: Calls are signalled.</li> <li>• <i>On</i> (<b>CS4xx</b> series only): Calls are not signalled.</li> <li>• <i>Acknowledgement Tone only</i> (<b>CS4xx</b> series only): An attention tone is heard once for a call</li> <li>• <i>Attention tone 1</i> (only <b>S530</b> and <b>S560</b>)</li> <li>• <i>Attention tone 2</i> (only <b>S530</b> and <b>S560</b>)</li> <li>• <i>Attention tone 3</i> (only <b>S530</b> and <b>S560</b>)</li> <li>• <i>Attention tone 4</i> (only <b>S530</b> and <b>S560</b>)</li> <li>• <i>No attention tone</i> (only <b>S530</b> and <b>S560</b>)</li> </ul>

The menu **Advanced Settings** consists of the following fields:

#### Fields in the menu **Advanced Settings**

Field	Description
<b>Status LED</b>	<p>Select whether and, if so, which events should be signalled by the system telephone status LED.</p> <p>Possible values:</p> <ul style="list-style-type: none"> <li>• <i>Off</i>: The status LED function is not used.</li> <li>• <i>Caller List</i>: The status LED signals calls and new messages.</li> <li>• <i>Messages only</i>: The status LED only signals new messages (MWI).</li> <li>• <i>New Message</i> (only <b>S5x0</b>)</li> <li>• <i>New Call</i> (only <b>S5x0</b>)</li> <li>• <i>Active Call</i> (only <b>S5x0</b>)</li> </ul> <p>You can use the options <i>New Message</i>, <i>New Call</i> and <i>Active Call</i> individually, or combine them freely.</p>
<b>Directory Softkey</b>	<p>Only for telephones in the <b>CS4xx</b> series</p> <p>Select whether calls shall be made with the softkey entries from the system phone book ( <i>System</i>) or from the telephone phone book ( <i>Telephone</i>).</p>
<b>Conversation Display</b>	<p>Not for <b>S5x0</b></p> <p>Select which information shall be indicated in the system telephone display during a call.</p> <p>Possible values:</p> <ul style="list-style-type: none"> <li>• <i>Number and Charge or Duration</i></li> <li>• <i>Number and Charge</i></li> <li>• <i>Number and Duration</i></li> <li>• <i>Number and Time</i></li> <li>• <i>Number only</i></li> <li>• <i>Date and Time only</i></li> </ul>
<b>Default Signalling during Calls</b>	<p>Select whether DTMF signals or keypad functions shall be transmitted into the system in call status. You can use special functions during a call by entering character and numerical sequences. These entries must be made as keypad or MFV se-</p>

Field	Description
	<p>quences, depending on the function to be used. You can define whether MFV or keypad functions are possible in the basic setting during a call.</p> <p>Possible values:</p> <ul style="list-style-type: none"> <li>• <i>DTMF</i> (default value)</li> <li>• <i>Keypad</i></li> </ul>
<b>Automatic Call Pick-up</b>	<p>Select the period after which calls to this system telephone should be automatically accepted without you having to pick up the receiver or press the loudspeaker key.</p> <p><i>Please note that to be able to use this function at least one telephone key must be assigned to automatic call acceptance.</i></p> <p>Possible values:</p> <ul style="list-style-type: none"> <li>• <i>Immediately</i></li> <li>• <i>After 5 seconds</i></li> <li>• <i>After 10 seconds</i></li> <li>• <i>After 15 seconds</i> (only <b>S5x0</b>)</li> <li>• <i>After 20 seconds</i> (only <b>S5x0</b>)</li> <li>• <i>Off</i> (only <b>S5x0</b>)</li> </ul>
<b>Mute after hands-free Calling</b>	<p>Not for <b>S5x0, CS290, CS290-U</b></p> <p>You can dial the number of a subscriber without picking up the receiver (e. g. hands-free). Here, you have the choice of whether the built-in microphone shall be switched on immediately or only after pressing of the corresponding softkey. If the microphone is turned off during dialling, the corresponding softkey must be pressed, even if the connection is already active.</p> <p>The function is activated by selecting <i>Enabled</i>.</p> <p>The function is disabled by default.</p>
<b>Receiving UUS</b>	<p>Select whether performance feature UUS (User to User Signalling) can be used for this telephone. With this performance feature, you can receive short text messages from other telephones. In this way, you can send written information within the</p>

Field	Description
	<p>system, e. g. <i>Meeting at 9:30 AM</i> or <i>Will be on holiday on Monday.</i></p> <p>Possible values:</p> <ul style="list-style-type: none"> <li>• <i>Off, UUS are blocked</i>: The UUS performance feature is not used.</li> <li>• <i>Internal only</i>: Text messages can only be received internally.</li> <li>• <i>External only</i>: Text messages can only be received externally.</li> <li>• <i>Internal and External</i> (default value): Text messages can only be received internally and externally.</li> </ul>
<p><b>Receive System Intercom Call</b></p>	<p>Select whether the system telephone assigned may accept simplex connections. If the system has more than one number then the settings are only applied to the first MSN.</p> <p>The function is activated by selecting <i>Enabled</i>.</p> <p>The function is disabled by default.</p>
<p><b>Receive Announcement Calls</b></p>	<p>Select whether the system telephone assigned may receive announcements. If the system has more than one number then the settings are only applied to the first MSN.</p> <p>The function is activated by selecting <i>Enabled</i>.</p> <p>The function is disabled by default.</p>

### 25.6.1.2 Keys / T400 / T400/2 / T500

In the menu **elmeg System Phones->Assigned System Phones->Keys** configuration of system telephone keys is displayed.

Your telephone features several function keys to which you can assign various functions on two levels. The functions that can be programmed on the keys vary from telephone to telephone.

Every function key with automatic LED functions (e. g. connection keys, line keys) can only be programmed once per system (telephone and key extensions).



**Values in the list Keys**

Field	Description
<b>Key</b>	Displays the name of the key.
<b>Label Description</b>	Displays the text which you have entered for the labelling page. The text contains the configured key name
<b>Key Type</b>	Displays the key type.
<b>Settings</b>	Displays the additional settings with a summary

You can use **Print** to print out a label sheet for the label field on your system telephone or your key extension.

**Edit**

Choose the  icon to edit existing entries. In the pop-up menu, you configure the functions of your system telephone keys.

You can use the following functions with system telephones:

- *Dial Key (Standard)*: You can store a call number on every function key.
- *Dial Key (DTMF)*: You can store a MFV sequence on every function key.
- *Dial Key (Keypad sequence)*: You can store a keypad sequence on every function key.
- *Extension Key (User)*: You can set up dialling to an internal extension using a line key. After pressing the corresponding key, hands free is switched on and the internal extension entered is selected. If a call is signalled on the internal extension you have entered, you can pick this up by pressing the line key.
- *Extension Key (Team)*: You can set up dialling to a team using a line key. After pressing the corresponding key, hands-free is activated and the entered team is called according to its enabled call option. If a call is signalled for the entered team, you can pick it up by pressing this connection key.
- *Trunk Line*: An ISDN connection or a VoIP provider is set up under a connection key. If this key is pressed, automatic hands-free is enabled and the corresponding ISDN connection is assigned. You then hear the external dialling tone. If an external call is signalled on another internal telephone, you can pick it up by pressing this line key.
- *Login / Log Out, Team*: If you are entered as a subscriber in the call assignments for one or more teams, you can set up a key so that you can control the call signalling of your telephone. If you're logged in, team calls are signalled to your telephone. If you are logged out, no team calls will be signalled.

The call numbers entered in the telephone can be logged in/logged out from a team using a set function key (**MSN-1... MSN-9**). Before entering a team number, you must select the telephone call number index (MSN) that is entered in the corresponding team call assignments.

- *System Call (Announcement User)*: You can set up a connection to another telephone without this connection having to be actively accepted. As soon as the telephone has accepted the announcement, the connection is established and the announcement key LED is enabled. The announcement can be ended by renewed pressing of the announcement key or by pressing the loudspeaker key. The LED switches off again at conclusion of the announcement.
- *System Call (Announcement Team)*: You can configure an announcement for a team by setting up a function key. The way this works is the same as that described above.
- *System Call (Announcement enable)*: You can also selectively deny or allow announcements using a function key. To use announcements, you must be authorised for the corresponding authorisation class.
- *System Call (Intercom)*: You can set up a key in such a way that a connection to the specified telephone is established without this connection having to be actively accepted.
- *System Call (Intercom enable)*: You can set up a key in such a way that the simplex operation function is allowed or denied. To use simplex operation, the function must be allowed in the corresponding authorisation class.
- *Boss Key/ Secretary Key*: You can set up a key as a special line key. The Boss telephone and Secretary telephone properties are saved in both telephones with these keys.
- *Diversion Secretary*: You can set up a key in such a way that incoming calls to the Boss telephone are automatically routed to the Secretary telephone.
- *Call Forwarding (CFNR)*: You can set up a key so that delayed call diversion is set up for a specific number (MSN) on your system telephone. Pressing the key when the phone is not in use turns call forwarding on and off. Configuring call forwarding with a programmed key is only possible for numbers 1 to 9 (MSN-1...MSN-9) on the phone. In order to be able to use call forwarding, you need to have set up at least one number.
- *Call Forwarding (CFU)*: You can set up a key so that immediate call diversion is set up for a specific number (MSN) on your system telephone. Pressing the key when the phone is not in use turns call forwarding on and off. Call forwarding configuration over a programmed key is only possible for numbers 1 to 9 (MSN-1...MSN-9) of the phone. In order to be able to use call forwarding, you need to have set up at least one number.
- *Call Forwarding (CFB)*: You can set up a key so that call diversion on engaged is set up for a specific number (MSN) on your system telephone. Pressing the key when the phone is not in use turns call forwarding on and off. Call forwarding configuration over a

programmed key is only possible for numbers 1 to 9 (MSN-1...MSN-9) of the phone. In order to be able to use call forwarding, you need to have set up at least one number.

- *Macro Function*: You can configure a key so that by pressing it a saved macro is executed.

The macro function can only be programmed at the phone.

- *Headset Control* (not with the **S5x0**): If you've connected and configured a headset to your telephone over a separate headset socket, operation of the headset occurs over a function key. Press the headset key to initiate or accept calls. If you already have an active connection over the headset, you can end the call by pressing the headset key.
- *Automatic Call Pick-up*: Your telephone can accept calls automatically without you having to lift the receiver or press the loudspeaker key. Automatic call acceptance is switched on or off using the function key assigned. You can configure a separate function key for each number ("MSN-1"... "MSN-9"), or a function key for all numbers. The period after which calls are automatically accepted is configured once for all numbers of the telephone.
- *Trunk Group Access*: Several external ISDN (if supported by your device) or IP connections to bundles can be grouped in the system. With a bundle key, you can save these connections on a function key. If this key is pressed, automatic hands-free is enabled and a free B channel of the corresponding bundle is assigned. You then hear the external dialling tone.
- *Connection Key* (not with the **S5x0**): In addition to the softkeys "Connection 1..", function keys can be configured on the system telephone or the extension for operation while brokering. At least two connection keys must be configured.
- *Hotel Room*: You can assign a key in such a way that when pressed, the guest is checked in or out (first level), or the selected hotel room phone is called (second level). You must configure this key on the first level, then the connected key on the second level is automatically assigned and, as the case applies, its content overwritten.
- *System Parking*: The called party is put on hold for enquiry and dials a code. The telephone is now freed for other operations, e. g. announcements. Another party can accept the call, if he lifts the receiver and dials the relevant code of the held call. The codes assigned by the PABX can also be entered in the function keys of one or more system telephones. If a call is set to open hold for enquiry by pressing the function key, this is indicated by flashing LEDs on the function keys for the system telephones set up for this. The call is transferred by pressing the corresponding function key. This performance feature is only possible if only one call is on hold.
- *Agent wrap-up Time*: You can configure a key so that when it is pressed, an agent's post-processing time is switched on or off at a team call centre (first level), or extended (second level).
- *Night Mode*: You can configure a key so that by pressing it night operation is switched on or off.



### Note

To manually switch night operation off again, the authorisation class **Switch signalling variants manually** must be enabled.

- *Parallel Ringing* (only **S5x0**): If a parallel call to another telephone is configured, both connections will ring when a call comes in. The call is accepted where first picked up.
- *Shift* (only **S5x0**): With this key, you can access second level functions.
- *Do not Disturb* (only **S5x0**): With this key, you enable or disable the Do not Disturb function which you have configured under **Terminals->elmeg System Phones->System Phone->Settings**.

The **elmeg System Phones->Assigned System Phones->Keys-> Edit** menu consists of the following fields:

#### Fields in the menu Phone: Type x

Field	Description
<b>Key name</b>	Enter a name for the key to be used as text for the corresponding key when the ID labels are printed.
<b>Key Type</b>	<p>Depending on the model, the telephones feature from 5 to 15 keys on which functions may be assigned over two levels. You can reach the second layer of function keys by pressing the keys twice. This must be done quickly. With <b>S5x0</b> devices, you can alternately use the <i>Shift</i> function key. With the optional bintec elmeg key extensions, you have access to additional twice-assignable function keys.</p> <p>Possible values:</p> <ul style="list-style-type: none"> <li>• <i>Dial Key (Standard)</i></li> <li>• <i>Dial Key (DTMF)</i></li> <li>• <i>Dial Key (Keypad sequence)</i></li> <li>• <i>Extension Key (User)</i></li> <li>• <i>Extension Key (Team)</i></li> <li>• <i>Trunk Line</i></li> <li>• <i>Login / Log Out, Team</i></li> <li>• <i>System Call (Announcement User)</i></li> <li>• <i>System Call (Announcement Team)</i></li> </ul>

Field	Description
	<ul style="list-style-type: none"> <li>• <i>System Call (Announcement User)</i></li> <li>• <i>System Call (Announcement enable)</i></li> <li>• <i>System Call (Intercom)</i></li> <li>• <i>System Call (Intercom enable)</i></li> <li>• <i>Boss Key</i></li> <li>• <i>Secretary Key</i></li> <li>• <i>Diversion Secretary</i></li> <li>• <i>Call Forwarding (CFNR)</i></li> <li>• <i>Call Forwarding (CFU)</i></li> <li>• <i>Call Forwarding (CFB)</i></li> <li>• <i>Macro Function</i></li> <li>• <i>Headset Control</i></li> <li>• <i>Automatic Call Pick-up</i></li> <li>• <i>Trunk Group Access</i></li> <li>• <i>Connection Key</i></li> <li>• <i>Hotel Room</i></li> <li>• <i>System Parking</i></li> <li>• <i>Agent wrap-up Time</i></li> <li>• <i>Night Mode</i></li> <li>• <i>Shift key (S5x0 only)</i></li> <li>• <i>Parallel call (only S5x0)</i></li> <li>• <i>Station guarding (quiet) (S5x0 only)</i></li> </ul>
<b>Number</b>	<p>Only where <b>Key Type</b> = <i>Dial Key (Standard)</i>, <i>Dial Key (DTMF)</i> and <i>Dial Key (Keypad sequence)</i></p> <p>You can save a number, an MFV sequence or a keypad sequence on every function key. Enter the call number or the code for the MFV/keypad sequence.</p>
<b>Internal Number</b>	<p>Where <b>Key Type</b> = <i>Extension Key (User)</i></p> <p>Select the internal number of a user to be called when this key is pressed.</p> <p>Where <b>Key Type</b> = <i>System Call (Announcement User)</i></p>

Field	Description
	<p>Select the internal number of a user to whose telephone an announcement shall be sent.</p> <p>When <b>Key Type</b> = <i>Login / Log Out, Team</i></p> <p>Select the internal number of a team to be logged into or out of when this key is pressed.</p> <p>When <b>Key Type</b> = <i>Receive Announcement Calls</i></p> <p>Select the internal number of a user on whose telephone an announcement shall be made.</p> <p>When <b>Key Type</b> = <i>Receive Intercom Calls</i></p> <p>Select the internal number of a user with which you wish to conduct simplex operations.</p> <p>When <b>Key Type</b> = <i>Call Forwarding (CFNR), Call Forwarding (CFU), Call Forwarding (CFB)</i></p> <p>Select the internal number of a telephone MSN from which the indicated destination number can be forwarded</p> <p>When <b>Key Type</b> = <i>Automatic Call Pick-up</i></p> <p>Select the internal number of this telephone, on which incoming calls shall be automatically accepted.</p> <p>When <b>Key Type</b> = <i>Hotel Room</i></p> <p>Select the internal number of a hotel guest.</p> <p>When <b>Key Type</b> = <i>Agent wrap-up Time</i></p> <p>Select the internal number of a user whose post-processing time shall be modified at regular intervals when this key is pressed.</p> <p>When <b>Key Type</b> = <i>Parallel Ringing</i></p> <p>Select the internal number of a user whose phone should also ring when a call goes in to you.</p>
<b>Automatic Call Pick-up</b>	<p>Where <b>Key Type</b> = <i>Automatic Call Pick-up</i></p> <p>Select when a call shall be automatically accepted by the</p>

Field	Description
	<p>entered internal subscriber.</p> <p>Possible values:</p> <ul style="list-style-type: none"> <li>• <i>Immediately</i>: The call is immediately and automatically accepted.</li> <li>• <i>After 5 seconds</i>: The call is automatically accepted after 5 seconds.</li> <li>• <i>After 10 seconds</i>: The call is automatically accepted after 10 seconds.</li> <li>• <i>After 15 seconds (only S5x0)</i>: The call is automatically accepted after 15 seconds.</li> <li>• <i>After 20 seconds (only S5x0)</i>: The call is automatically accepted after 20 seconds.</li> <li>• <i>Off (only S5x0)</i>: The call is not automatically accepted.</li> </ul>
<b>Team</b>	<p>Where <b>Key Type</b> = <i>Extension Key (Team)</i></p> <p>Select the internal number of a team to be called when this key is pressed.</p> <p>Where <b>Key Type</b> = <i>System Call (Announcement Team)</i></p> <p>Select the internal number of a team to whose telephone an announcement shall be sent.</p> <p>When <b>Key Type</b> = <i>Login / Log Out, Team</i></p> <p>Select the internal number of a team to be logged in/out when this key is pressed.</p>
<b>Trunk Line</b>	<p>Only where <b>Key Type</b> = <i>Trunk Line</i></p> <p>Select the external connection over which an external call shall be set up when this key is pressed.</p>
<b>Number of Secretary Phone</b>	<p>Only where <b>Key Type</b> = <i>Boss Key</i></p> <p>Select the internal number of the secretary telephone. The secretary telephone is called when this key is pressed.</p>
<b>Number of Boss Phone</b>	<p>Only where <b>Key Type</b> = <i>Secretary Key</i></p>

Field	Description
	Select the internal number of the Boss telephone. The Boss telephone is called when this key is pressed.
<b>Target Number "On no reply"</b>	Only where <b>Key Type</b> = <i>Call Forwarding (CFNR)</i> Enter the number to which calls shall be forwarded immediately when call forwarding is enabled.
<b>Target Number "Immediate"</b>	Only where <b>Key Type</b> = <i>Call Forwarding (CFU)</i> Enter the number to which calls shall be forwarded when call forwarding when busy is enabled.
<b>Target Number "On busy"</b>	Only where <b>Key Type</b> = <i>Call Forwarding (CFB)</i> Enter the number to which calls shall be forwarded when call forwarding is enabled when the call is not answered.
<b>Trunk Group Access</b>	Only where <b>Key Type</b> = <i>Trunk Group Access</i> Select the bundle via which an outside call shall be set up.
<b>Waiting Queue</b>	Only where <b>Key Type</b> = <i>System Parking</i> Select the queue in which the current call should be held.

### Move

Select the  icon to move configured function keys.

### Fields in the menu Phone

Field	Description
<b>Key name</b>	Displays the name of the key.
<b>Key Type</b>	Displays the key type.
<b>Settings</b>	Displays the additional settings with a summary

### Fields in the menu Move to



Field	Description
<b>Phone</b>	Displays your system telephone. In <b>User Access</b> you can only move keys within your own telephone key extension combination.
<b>Module</b>	Select telephone or a key extension module.
<b>Key</b>	Select the key to which you wish to transfer the configured function.

### 25.6.1.3 Device Info

In the **elmeg System Phones->Assigned System Phones->Device Info** menu the system data read out of the system telephone are displayed.

#### Meaning of the list entries

Description	Meaning
<b>Description</b>	Displays the entered description of the telephone.
<b>Phone Type</b>	Displays the type of telephone.
<b>Serial Number</b>	Displays the serial number of the telephone.
<b>Software Version</b>	Displays the current version of the telephone software.
<b>Release Date and Time</b>	Displays the date and time of the telephone software version.
<b>Last Device Configuration</b>	Displays the date and time of the last telephone configuration.
<b>Answering Machine</b>	Displays whether an answering machine module is inserted in the telephone (Yes) or not (No).

#### Meaning of the key extension

Description	Meaning
<b>Module 1: Type / Serial Number</b>	Displays the type and serial number of the connected key extension.
<b>Module 2: Type / Serial Number</b>	

Description	Meaning
<b>Module 3: Type / Serial Number</b>	
<b>Module 1: Software Version</b>	Displays the current software version of the connected key extension.
<b>Module 2: Software Version</b>	
<b>Module 3: Software Version</b>	

## 25.7 Voice Mail System

You can access information on you voicemail box in the **Voice Mail System** menu.



### Note

The **Voice Mail System** menu is only displayed once a personal voicemail box has been set up for you.

### 25.7.1 Settings

In the **Voice Mail System** ->**Settings** menu, your voicemail box settings are displayed.

#### Values in the Settings list

Field	Description
<b>Internal Number</b>	Displays your internal number.
<b>User</b>	Displays your user name.
<b>Status of Mail Box Owner</b>	Displays your status.
<b>Check PIN</b>	Indicates whether access to your voicemail box is protected by a PIN.
<b>Mode for status "In the</b>	Indicates in which mode your voicemail box operates for the "In

Field	Description
Office"	Office" status.
Mode for status "Out of Office"	Indicates in which mode your voicemail box operates for the "Out of Office" status.
New Calls	Indicates the number of new calls.
Old Calls	Indicates the number of old calls.
Saved Calls	Indicates the number of saved calls.

### 25.7.1.1 Edit

Choose the  icon to edit existing entries. You can change the settings of selected parameters.

The menu **Voice Mail System ->Settings** consists of the following fields:

#### Fields in the Basic Settings menu.

Field	Description
Status of Mail Box Owner	<p>Define in which mode your mailbox shall be used when starting the voicemail system.</p> <p>Possible values:</p> <ul style="list-style-type: none"> <li>• <i>In the Office</i> (default value): Select this setting if you're in the office when the voicemail system is started.</li> <li>• <i>Out of Office</i> : Select this setting if you're out of the office when the voicemail system is started.</li> </ul>
Check PIN	Select whether your voicemail box should be protected with a PIN.
Mode for status "In the Office"	<p>Your voicemail box can be operated with two different settings during office hours.</p> <p>Possible values:</p> <ul style="list-style-type: none"> <li>• <i>Announcement only</i>: A caller hears an announcement, but cannot leave a message.</li> <li>• <i>Announcement and Record</i>: A caller hears an announce-</li> </ul>

Field	Description
	ment and can leave a message.
<b>Mode for status "Out of Office"</b>	<p>Your voicemail box can be operated with two different settings outside office hours.</p> <p>Possible values:</p> <ul style="list-style-type: none"> <li>• <i>Announcement only</i>: A caller hears an announcement, but cannot leave a message.</li> <li>• <i>Announcement and Record</i>: A caller hears an announcement and can leave a message.</li> </ul>

#### Fields in the Voice Mail Message via E-Mail menu.

Field	Description
<b>E-Mail Notification</b>	<p>Once a message has been left on the voicemail box, the subscriber can be notified.</p> <p>Possible values:</p> <ul style="list-style-type: none"> <li>• <i>None</i> (default value): The subscriber is not notified.</li> <li>• <i>E-Mail</i>: The subscriber is informed of a present message via e-mail.</li> <li>• <i>E-Mail with Attachment</i>: Once a caller has left a message, the subscriber receives an e-mail with a recording of the message in the attachment.</li> </ul>
	<p> <b>Note</b></p> <p>After a subscriber has been informed about a new message through an E-Mail, the <b>Status</b> of the message is changed according to the configuration in <b>User Access-&gt;Voice Mail System -&gt;Settings</b> under <b>E-Mail forwarding behavior</b>.</p>
<b>E-Mail forwarding behavior</b>	<p>Only for <b>E-Mail Notification</b> = <i>E-Mail</i> or <i>E-Mail with Attachment</i></p> <p>Select an option for forwarded messages.</p> <p>Possible values:</p> <ul style="list-style-type: none"> <li>• <i>Keep Message in 'new' after forwarding</i>: Follow-</li> </ul>

Field	Description
	<p>ing an e-mail alert or forwarding, the status of the voicemail message is set to <i>New</i>.</p> <ul style="list-style-type: none"> <li>• <i>Move Message to 'old' after forwarding</i>: Following an e-mail alert or forwarding, the status of the voicemail message is set to <i>Old</i>.</li> <li>• <i>Remove Message after forwarding</i>: The voicemail message is deleted following an e-mail alert or forwarding.</li> </ul>

## 25.7.2 Messages

In the **Voice Mail System** -> **Messages** menu, a list of your messages is displayed. You also have the option to play back voicemail messages or download these to your PC. To save a message, click on the  icon. The download dialog then opens. To listen to a message, click on the  icon.

Individual or all wave files can be deleted by clicking the **Select all / Deselect all** checkbox then pressing **Delete Selected**.

### Values in the Messages list

Field	Description
<b>Internal Number</b>	<p>Displays the internal number of a voicemail box.</p> <p>Several internal numbers can be assigned to a single user. The user can operate a separate voicemail box under each internal number.</p>
<b>User</b>	Displays the name of the voicemail box user.
<b>Call from</b>	Displays the caller's number.
<b>Date/Time</b>	Displays the date and time of the call.
<b>Call Status</b>	Indicates whether the call is <i>New</i> , <i>Old</i> or <i>Saved</i> .
<b>Select all / Deselect all</b>	You can select individual entries using the checkbox in the corresponding line, or select them all using the <b>Select all</b> button or <b>Deselect all</b> . You can delete the selected entries by pressing the <b>Delete Selected</b> option.

## Glossary

<b>2G</b>	See GSM.
<b>3DES</b>	See DES.
<b>3G</b>	See UMTS.
<b>4G</b>	See LTE.
<b>802.11</b>	The 802.11 norm describes wireless LAN (WLAN). There are a variety of amendments: 802.11a: Gross data transfer rates: 54 Mbit/s, frequency band: 5 GHz, 802.11b/g: Gross data transfer rates: 11 Mbit/s, frequency band: 2.4 GHz, 802.11g: Gross data transfer rates: 54 Mbit/s, frequency band: 2.4 GHz, 802.11n: Gross data transfer rates: 600 Mbit/s, frequency band: 2.4 GHz (optional: 5 GHz)
<b>A-subscriber</b>	The A-subscriber is the caller.
<b>a/b interface</b>	An a/b interface is used to connect an analogue terminal. In the case of an ISDN terminal (terminal adapter) with a/b interface, a connected analogue terminal is enabled to use the supported ISDN performance features.
<b>Access client</b>	Client mode is an operating mode of a wireless access point (AP) in which the latter behaves like a wireless adapter vis-a-vis the higher level AP. With an AP run in client mode, individual computers or entire sub-networks can be connected to higher level networks.
<b>Access point</b>	An access point (AP) is a device for wirelessly connecting clients (computers). The AP thus serves to create a wireless network (WLAN) and connect that WLAN to a wired Ethernet network (bridging).
<b>Accounting</b>	Accounting refers to the recording of connection data, e.g. date, time, connection duration, charging information and number of data packets transferred.
<b>Activity monitor</b>	The activity monitor is used to oversee the status of physical and virtual device interfaces.
<b>Ad-hoc network</b>	In an ad-hoc network, individual clients connect to an independent wireless LAN via a wireless adapter. Ad-hoc networks work independently, with no access point on a peer-to-peer basis. The ad-hoc mode is also referred to as IBSS (Independent Basic Service Set)

mode and is useful in very small networks, e. g. when linking two notebooks with no access point.

**ADSL**

Asymmetric digital subscriber line. See DSL.

**AES**

Advanced Encryption Standard (AES, Rijndael) is an encryption method (see Cipher). AES uses a fixed block length of 128 bits. The key length is 128, 192 or 256 bits. AES is a very fast and secure algorithm.

**Agent**

The call centre agent is a member of a call centre.

**Aggressive mode**

When an IPSec connection is being established, aggressive mode is used to implement a phase 1 exchange. Aggressive mode offers no identity protection for negotiating nodes, since they have to transmit their identity before they can establish a secure channel. See also Main mode.

**AH**

The authentication header (AH) is used with IPSec to ensure the authenticity and integrity of the packets transmitted and to authenticate the sender.

**Analogue**

Analogue signals are used to transmit data. They are more susceptible to errors than digital signals.

**Analogue terminals**

Terminals that transmit voice and other information analogously, e.g. telephones, fax machines, answering machines and modems. Performance features can only be used with terminals that dial using the MFC dialling method and that have an R or flash key.

**Annex A**

Annex A is a DSL variant which occurs in connection with analogue telephone connections, e. g. in France.

**Annex B**

Annex B is a DSL variant which occurs in connection with ISDN, e. g. in Germany.

**Annex J**

Annex J is a DSL variant purely for data transmission, with no voice data (unbundled connection). Annex J is an extension of specification G.992. These DSL connections require no splitter and have a greater range and faster transmission speed.

**Annex L**

Annex L is an extension of Annex A. The range is increased at the expense of the data transmission rate.

**Annex M**

Annex M is an extension of Annex A. The upstream is increased at the expense of the downstream.

<b>Announcement</b>	The announcement is a performance feature. The announcement function enables a connection to be established to other phones which is automatically accepted by the subscribers called. The caller speaks and those called hear the announcement. If one of those called lifts the receiver, a normal connection is established.
<b>ANSI T1.413</b>	ANSI T1.413 is an ADSL variant.
<b>Answering machine</b>	Analogue answering machines are configured as an analogue terminal and selected via the terminal type. The PABX voice mail system is used as the answering machine.
<b>ARP</b>	The Address Resolution Protocol (ARP) supplies the associated MAC addresses to IPv4 addresses. The information required is shared between the network nodes, stored in the device's cache, and deleted again after the ARP lifetime has expired. For IPv6 this functionality is provided by the Neighbor Discovery Protocol (NDP).
<b>ARS</b>	The PABX uses Automatic Route Selection (ARS) to determine the ideal route to the called party, depending on the provider, service, QoS, ...
<b>ATM</b>	Asynchronous Transfer Mode (ATM) is a data transmission technology in which the data traffic is coded in small packets – called cells or slots – with a fixed length and is transmitted via asynchronous time multiplexing.
<b>Authentication</b>	Check on the user's identify.
<b>Authorisation</b>	Based on their identity (authentication), the user can access certain services and resources.
<b>Authorisation class</b>	See CoS.
<b>Automatic callback on busy (CCBS)</b>	Callback on busy is a performance feature. If the connection of the subscriber called is engaged, a callback can be requested. When the called subscriber's phone call ends, the caller is phoned and automatically connected to the called subscriber.
<b>Automatic callback on no reply (CCBS)</b>	Callback on no reply is a performance feature. If the called subscriber fails to take the call, a callback can be requested. When the called subscriber ends a call, the caller is phoned and automatically connected to the called subscriber.
<b>Automatic outside line</b>	Automatic outside line enables the phone number of an external party to be dialled (without entering a code).



<b>Automatic redialling</b>	If the connection of the called party is engaged, an automatic redial can be initiated. This notifies the caller as soon as the line is free.
<b>Automatic Route Selection</b>	Automatic route selection can be used to route calls whatever the number (zone) dialled, via specified providers or bundles.
<b>AUX</b>	AUX is a signal input for external devices, e. g. analogue or GSM modems.
<b>B channel</b>	See Basic Rate Interface and Primary Rate Interface.
<b>B channel</b>	See B channel.
<b>B subscriber</b>	The B subscriber is the called party.
<b>Back Route Verify</b>	If a Back Route Verify is activated for an interface, incoming data packets are only accepted over this interface if outgoing response packets are routed over the same interface.
<b>Backbone area</b>	The core area of a network which connects all the sub-networks (areas) with one another is known as the backbone.
<b>Basic Rate Interface</b>	The Basic Rate Interface is a network connection to the ISDN. This type of connection is often abbreviated to BRI. A basic rate interface includes two basic channels (B channels) each with 64 kbps and one control and signalling channel (D channel) with 16 kbps. There are two operating modes for the Basic Rate Interface: Point-to-point ISDN and Point-to-multipoint The Primary Rate Interface (PRI) is used with larger installations.
<b>Beacon</b>	The central access point sends beacons to create a wireless LAN in infrastructure mode. These messages contain the network name (SSID), a list of the supported transmission rates and the type of encryption.
<b>Bit</b>	A binary digit (bit) is the smallest unit of data in computing technology. Signals are represented in the logical states "0" and "1".
<b>Black / White List</b>	Entries in the Black List are blocked, entries in the White List are allowed through. (Example: Any telephone number beginning with 01234 is blocked in the Black List. The number 01234987 can nonetheless be approved in the White List.)
<b>Blowfish</b>	Blowfish is an encryption method (see Cipher). Blowfish uses a fixed block length of 64 bits. The key length can be between 32 and 448 bits.

<b>BootP</b>	The Bootstrap Protocol (BootP) is used to automatically issue an IP address.
<b>Bps</b>	Bits per second. A unit of measure for the transmission rate.
<b>BRI</b>	See Basic Rate Interface
<b>Bridge</b>	A bridge is a network component for connecting the same types of network at Level 2 of the OSI model. Data packets are transmitted using MAC addresses. The use of bridges divides up the network and reduces the load.
<b>Broadcast</b>	In a broadcast, data packets are sent from one point to all the subscribers in a network, e. g. if the recipient is not yet known. Examples of this are the ARP and DHCP protocols. The communication is via broadcast addresses: MAC networks: FF:FF:FF:FF:FF:FF, IPv4 networks: 255.255.255.255, IPv6 networks: ff00::/8
<b>Broker</b>	Brokering makes it possible to switch between two subscribers without the waiting subscriber being able to hear the other conversation.
<b>BRRP</b>	BRRP is an implementation of the Virtual Router Redundancy Protocol (VRRP). The aim of the method is to compensate for the failure of the default gateway. Multiple routers are combined to form one virtual router. If one of these routers falls over, the others are able to replace it.
<b>Bundle</b>	The external connections of a PABX can be grouped into bundles.
<b>Busy On Busy</b>	If Busy on Busy is enabled, anyone who calls an engaged subscriber hears the engaged tone. Call waiting or call forwarding to a team are not possible.
<b>CA</b>	Certificate Authority. See Certificate.
<b>Cache</b>	The device temporarily stores data used in name resolution in the cache. See also ARP.
<b>Call allocation</b>	With call allocation, calls coming into the PBX are assigned to particular numbers or applications (remote access, ISDN login, ...).
<b>Call centre</b>	A call centre provides support, shares information and sells over the telephone.
<b>Call deflection</b>	Call deflection (CD) is a performance feature. A call can be forward-

ded without it having been taken.

- Call deflection (CD)** See Call forwarding.
- Call forwarding** Call forwarding is a performance feature. When call forwarding (CF) is used, incoming calls can be routed to another, internal or external, phone number. The call can be forwarded in the telephone system or the switchboard, or by the SIP provider.
- Call pickup** See pickup
- Call Through** Call Through refers to dialling into the system via an external connection and the system putting the call through to a different external connection. This can reduce call costs.
- Call variant** The call variant specifies which terminals a call is signalled to. The calendar can be used to control the individual call variants on a time basis.
- Call waiting** Call waiting is a performance feature. Another caller is signalled during a phone call.
- Call waiting protection** When call waiting protection is enabled, other callers are not signalled on the terminal. The caller hears the engaged tone.
- Callback on Busy** See Automatic callback on busy (CCBS)
- Callback on no reply** See Automatic callback on no reply (CCBS)
- Called party number** The number of the party being phoned.
- Caller list** On system telephones, missed calls are saved in a caller list. To achieve this, calling line identification presentation (CLIP) needs to be enabled.
- Calling party number** The number of the calling terminal.
- CAPI** The Common ISDN Application Programming Interface (CAPI) is a programming interface for ISDN. It enables application programs to access ISDN hardware from a PC. See also TAPI.
- CAPWAP** Control And Provisioning of Wireless Access Points Protocol (CAPWAP) is used to have wireless access points (slaves) monitored by a WLAN controller (master). It uses UDP port 5246 for monitoring and 5247 to send data.
- CAST** CAST is an encryption method (see Cipher). CAST uses a fixed

block length of 64 bits. The key length can be between 40 and 128 bits. Alternative names are CAST-128 and CAST5.

<b>Certificate</b>	A certificate identifies a person, an institution, a device or an application. A public key certificate is a digital certificate and it creates a connection between the identity and a public key. Certificates with public keys are issued by a certification authority (CA). Certificates that can no longer be trusted may be revoked using certificate revocation lists (CRLs)
<b>CFB</b>	Call Forwarding Busy (CFB) is a performance feature. CFB forwards callers to a different connection if the connection of the party called is engaged.
<b>CFNR</b>	Call Forwarding No Reply (CFNR) is a performance feature. CFNR forwards callers to a different connection if the call is not taken.
<b>Channel</b>	A wireless channel is a frequency band used for wireless LAN. Devices that send on adjacent channels disrupt one another.
<b>Channel bundling</b>	When channels are bundled, the B channels in an ISDN connection are combined to increase data throughput.
<b>CHAP</b>	The Challenge Handshake Authentication Protocol (CHAP) is an authentication protocol for PPP connections. As well as the standard CHAP, Microsoft also has the variants MS-CHAPv1 and MS-CHAPv2. You dial into a network via PPP and you authenticate yourself with a username and password. The username and password are transmitted encrypted. See also PAP.
<b>Cipher</b>	A block cipher is an encryption algorithm. In this encryption method, a data block of a fixed size (normally 64 bit) is rewritten to a block of the same size using a so-called key. The longer the key, the more secure the algorithm.
<b>CLID</b>	Calling Line Identification (CLID), also known as Caller ID, is used for authentication. A caller is identified by means of his or her ISDN extension number before the connection is established.
<b>Client</b>	A client uses the services provided by a server. Clients are usually workstations.
<b>CLIP</b>	See Display caller number (CLIP / CLIR).
<b>CLIP no Screening</b>	See also Display caller number (CLIP / CLIR). With CLIP no Screening, as well as the normal caller number, another number is also sent, e. g. the number of the switchboard or a service number. The

normal number can also be suppressed using CLIP, so that the party called only sees the other number.

<b>CLIP off Hook</b>	See Display caller number (CLIP / CLIR).
<b>CLIR</b>	See Display caller number (CLIP / CLIR).
<b>Code procedure</b>	A sequence (code procedure) (consisting of 0 - 9, *, # and R) can be entered on the telephone keypad in order to access the PBX's functions.
<b>COLP</b>	See Display called party number (COLP / COLR).
<b>COLP no Screening</b>	See also Display called party number (COLP / COLR). With COLP no Screening, as well as the normal caller number, another number is also sent, e. g. the number of the switchboard or a service number. The normal number can also be suppressed using COLP, so that the party called only sees the other number.
<b>COLR</b>	See Display called party number (COLP / COLR).
<b>Conference call</b>	With a conference call, multiple internal subscribers can speak to one another on the phone at the same time.
<b>Configuration</b>	The configuration refers to all of a device's settings. It is stored internally, in MIB tables. This data can be backed up, loaded and deleted externally. The configuration is edited using the HTTP(S) user interface, an SNMP client or connected telephones.
<b>CoS</b>	The term Class of Service (CoS) means different things depending on the area in which it is applied. In telecommunications CoS refers to the permission class assigned to the user. The permission class defines the user's rights, e. g. exchange access right, features that can be used, access to applications, ... In network technology CoS refers to the classification of certain services as per IEEE 802.1p. CoS enables priorities to be set in a targeted way, while Quality of Service (QoS) is used to set up explicit bandwidth guarantees or restrictions. Data packets are classified using a DSCP (Differentiated Services Code Point) value.
<b>CRC</b>	Cyclic Redundancy Check (CRC) is a method of detecting errors in the data transmission.
<b>CRL</b>	See Certificate.
<b>D channel</b>	See Basic Rate Interface and Primary Rate Interface.

<b>Daemon</b>	A daemon refers to a program that runs in the background and provides certain services.
<b>Data compression</b>	Data compression is a method of reducing the data volume transmitted. See STAC and MPPC.
<b>Datagram</b>	A datagram is a self-contained data entity with user and control data. It generally stands for the terms data frame, data packet and data segment.
<b>DCN</b>	DCN stands for data communication network.
<b>DDI</b>	DDI stands for Direct Dial In. See Point-to-point ISDN access and Direct dial-in (VoIP).
<b>Dead Peer Detection</b>	In IPSec, Dead Peer Detection is used to identify IKE peers that can no longer be accessed.
<b>DECT</b>	Digital Enhanced Cordless Telecommunications (DECT) is a standard for cordless telephones and wireless PABX systems.
<b>Default gateway</b>	All the data traffic which is not intended for one's own network is sent to the default gateway (default router).
<b>Default route</b>	See Standard route
<b>Default route</b>	The default route is used when no other suitable route is available.
<b>Default router</b>	See Default gateway.
<b>Diffie-Hellman</b>	Diffie-Hellman is a public key algorithm for negotiating and establishing keys. Because data is neither encrypted nor signed, the method is only secure if the connecting partners authenticate themselves using other mechanisms such as RSA and DSA.
<b>Denial-Of-Service Attack</b>	In a Denial-Of-Service Attack (DoS), a network component is flooded with queries so that it becomes totally overloaded. As a result, the system or a particular service can no longer function.
<b>DES</b>	The Data Encryption Standard (DES) is an encryption method (see Cipher). DES uses a fixed block length of 64 bits. The key length is 56 bits. Triple DES or 3DES is based on using DES three times (three different, independent keys).
<b>DHCP</b>	The Dynamic Host Configuration Protocol (DHCP) allows IP addresses to be assigned dynamically. A DHCP server allocates each client in a network an IP address from a defined address pool. The

clients need to be configured accordingly.

<b>Dial preparation</b>	Dial preparation describes the entering of the telephone number before initiating the call, e. g. by lifting the receiver.
<b>Dialling control</b>	See Black / White List.
<b>Dialup connection</b>	When required, a dialup connection is established by dialling a phone number, in contrast to a fixed connection (see Leased line) which is permanently enabled.
<b>Digital</b>	Digital signals are used to transmit data. They are less susceptible to errors than analogue signals.
<b>DIME</b>	Desktop Internetworking Management Environment (DIME) is used to configure and monitor gateways.
<b>Direct call</b>	If the direct call function is set up, the user merely has to lift the telephone receiver to, after a short wait, automatically get a connection to a particular phone number.
<b>Direct dial exception</b>	See Point-to-point ISDN access and Direct dial-in (VoIP).
<b>Direct dial-in (VoIP)</b>	Direct dial-in is a VoIP connection that is also known as point-to-point. It is used to connect a PBX. A main phone number and a number block are issued. Each of the numbers in the number block is called a direct dial exception. (Example: Main number 1234, number block: 1 - 99, numbers of the individual extensions: 1234-1, 1234-2, 1234-3, ...)
<b>Direct dialling range</b>	See number block in Point-to-point ISDN access and Direct dial-in (VoIP)
<b>DISA</b>	DISA - Direct Inward System Access A call, after it has been taken by the PBX, is automatically forwarded after a code has been entered. In the PBX, this code is assigned to an internal telephone number.
<b>Display called party number (COLP / COLR).</b>	Connected Line Identification Presentation (COLP) is used to send the phone number of the called party (B phone number) to the caller. Connected Line Identification Restriction (COLR) is used to suppress the transmission of the phone number of the called party to the caller.
<b>Display caller number (CLIP / CLIR).</b>	Calling Line Identification Presentation (CLIP) is used to send the caller's phone number (A phone number) to the called party. CLIP off Hook sends the phone number of the caller waiting. Calling Line

	Identification Restriction (CLIR) is used to suppress the transmission of the phone number of the caller to the called party.
<b>DNS</b>	The Domain Name System (DNS) is used to convert the domain name (e. g. www.example.org) to an IP address (name resolution).
<b>Do not disturb</b>	See Station guarding.
<b>Domain</b>	A domain is a contiguous sub-set of the DNS (e. g. example.org).
<b>Door intercom</b>	A door intercom is mounted on entrances, and may be part of a PBX.
<b>Downstream</b>	The gateway receives the data from a higher-level network and forwards it to its connected network.
<b>DSA</b>	The Digital Signature Algorithm (DSA) is used to create digital signatures and encrypt data packets. Signatures can be used to verify changes made to the information in the data packet. DSA is used for public-key cryptography (IPSec). See also RSA. Key generation is quicker with DSA than with RSA, but key processing is slower.
<b>DSCP</b>	Data packets can be marked with a Differentiated Services Code-point (DSCP). DSCP values classify data packets in such a way that important packets can be routed through the network more quickly. See also QoS.
<b>DSL modem</b>	See Modem.
<b>DSP</b>	A digital signal processor (DSP) converts analogue, ISDN and VoIP signals to one another. So, e. g., analogue terminals can also be used on an SIP connection.
<b>DSS1</b>	Digital Subscriber Signalling System No. 1 (DSS1) is a signalling protocol for the D channel in the ISDN. It is also known as Euro ISDN.
<b>DTIM</b>	A Delivery Traffic Indication Message informs the clients that multicast or broadcast data is available at the access point.
<b>DTMF</b>	See Multifrequency code dialling method.
<b>DTMF Inband / Outband</b>	See also Multifrequency code dialling method. With inband, the DTMF signal is transmitted in the voice band (G.711) With outband, the DTMF signal is transmitted as specified in RFC 2833.
<b>Dynamic IP address</b>	In contrast to a static IP address, a dynamic IP address is assigned



temporarily by DHCP. Network components such as the web server or printer usually have static IP address, while clients such as notebooks or workstations usually have dynamic IP addresses.

<b>DynDNS</b>	A DynDNS provider can be used to link a domain name with a dynamically changing IP address.
<b>Encapsulation</b>	Encapsulation of data packets is a particular protocol to transmit the data packets in a network. See also VPN.
<b>Encryption</b>	Refers to the encryption of data, e.g. using MPPE.
<b>Engaged when busy</b>	See Busy on Busy.
<b>ESP</b>	Encapsulating Security Payload (ESP) is a protocol for IPSec. It uses protocol number 50 and supports data encryption and authentication.
<b>Ethernet</b>	Ethernet is a specification for cable data networks. Ethernet works on the first and second layer of the OSI model.
<b>Euro ISDN</b>	Standard ISDN in Europe, based on the DSS1 signalling protocol.
<b>Eurofile transfer</b>	Eurofile transfer (EFT) is a protocol for sharing files over ISDN.
<b>Exchange access right</b>	The telephone system distinguishes between the following exchange access rights: Unlimited: Any international, national or internal connection is permitted. National long-distance calls: Only domestic connections may be established - i. e. dialling any number that begins with 0 but not with 00. Incoming external calls can be received without restrictions. Locality: Only connections to the same area code may be established. So the number may not begin with a 0. Incoming external calls can be received without restrictions. Incoming: Only connections to other terminals in the telephone system may be established. Incoming external calls can be received without restrictions. Internal: Only connections within the telephone system are permitted.
<b>Extension</b>	In PBX systems, an extension refers to the terminal connected to the system.
<b>Extension number</b>	See Point-to-point ISDN access and Direct dial-in (VoIP).
<b>Extension number block</b>	See Point-to-point ISDN access and Direct dial-in (VoIP).
<b>Extension numbers</b>	See Extension number block in Point-to-point ISDN access.

**range****Fax**

Fax is used to send text, graphics and documents over the phone network. A distinction is drawn between Group 3 fax machines for the analogue network (transmission rate: 9.6 or 14,4 kbit/s) and Group 4 fax machines for ISDN (transmission rate: 64 kbit/s). To connect Group 3 fax machines to ISDN, a terminal adapter or a suitable PBX is required.

**Filter**

A filter comprises a number of criteria (e.g. protocol, port number, source and destination address). If these criteria match a data packet, the data packet can be subjected to a particular action (forward, reject, ...). This creates a filter rule.

**Filter rule**

A rule that defines which data packets should or should not be transmitted by the gateway.

**Firmware**

The firmware (system software) is programming code that is permanently embedded in the device. It provides the device's functions.

**Flash key**

The flash key on a telephone is the R button. The key interrupts the line briefly to start certain functions such as inquiries.

**Follow-me**

Follow-me is a performance feature. This function can be used to route incoming calls from a different extension to one's own terminal.

**Fragmentation**

If the overall length of the data packet is greater than the Maximum Transmission Unit (MTU) of the network interface, the data packet has to be broken down into multiple physical data blocks using IP fragmentation. The reverse process is known as reassembly.

**Frame**

A data frame is an information unit (Protocol Data Unit) in the data link layer in the OSI model.

**Frame relay**

Frame relay is a data transmission technology and upgrade of X.25 (smaller packets, less error checking). Frame relay is primarily used for GSM networks.

**FTP**

The File Transfer Protocol (FTP) regulates data transmission in IP networks. It regulates the exchange between FTP server and client.

**Full-duplex**

With full-duplex, data can be sent and received simultaneously over a line.

**Function keys**

Function keys are special keys on system telephones which can be assigned phone numbers or functions.

<b>FXO</b>	Foreign Exchange Office (FXO) refers to the connection to the analogue terminal. See also FXS.
<b>FXS</b>	Foreign Exchange Station (FXS) refers to the analogue connection to the connection socket or PBX. See also FXO.
<b>G.711</b>	G.711 is an audio codec. Audio signals from the frequency range between 300 Hz and 3400 Hz are passed with a sampling rate of 8 kHz. At a data transmission rate of 64 kbit/s, the codec achieves excellent voice quality (MOS value: 4.4). The A-law quantisation method is used in Europe, and the $\mu$ -law method in the USA.
<b>G.722</b>	G.722 is an audio codec. Audio signals from the frequency range between 50 Hz and 7000 Hz are passed with a sampling rate of 16 kHz. At a data transmission rate of 64 kbit/s, the codec achieves outstanding voice quality (MOS value: 4.5).
<b>G.726</b>	G.726 is an audio codec. Audio signals from the frequency range between 200 Hz and 3400 Hz are passed with a sampling rate of 8 kHz. The codec achieves an acceptable voice quality. MOS value: 3.7 (16 kbit/s), 3.8 (24 kbit/s), 3.9 (32 kbit/s), 4.2 (40 kbit/s). There are two different coding methods: I.366 and X.420
<b>G.729</b>	G.729 is an audio codec. Audio signals from the frequency range between 300 Hz and 2400 Hz are passed with a sampling rate of 16 kHz. At a data transmission rate of 8 kbit/s, the codec achieves an acceptable voice quality (MOS value: 3.9).
<b>G.991.1</b>	Data transmission recommendation for HDSL.
<b>G.991.2</b>	Data transmission recommendation for SHDSL.
<b>G.992.1</b>	Data transmission recommendation for ADSL. There are two country-specific versions: G.992.1 Annex A and G.992.1 Annex B. Data transfer rates: 12 Mbit/s (downstream), 1.3 Mbit/s (upstream)
<b>G.992.2</b>	Data transmission recommendation for ADSL (G.LITE / ADSL-Lite). There are two versions: G.992.2 Annex A and G.992.2 Annex B. Data transfer rates: 12 Mbit/s (downstream), 1.3 Mbit/s (upstream)
<b>G.992.3</b>	Data transmission recommendation for xDSL2. There are three variants: G.992.3 Annex A/B (G.DMT to ADSL2) with data transmission rates of 12 Mbit/s in the downstream and 1.0 Mbit/s in the upstream, G.992.3 Annex L (RE-ADSL2) with data transmission rates of 5 Mbit/s in the downstream and 0.8 Mbit/s in the upstream and G.992.3 Annex M (ADSL2) with data transmission rates of 12 Mbit/s

	in the downstream and 2.5 Mbit/s in the upstream.
<b>G.992.4</b>	Data transmission recommendation for ADSL2 with Annex A/B. Data transmission rates: 12 Mbit/s (downstream), 1.0 Mbit/s (upstream)
<b>G.992.5</b>	Data transmission recommendation for xDSL2+. There are three variants: G.992.5 Annex A/B (ADSL2+) with data transmission rates of 25 Mbit/s in the downstream and 1.0 Mbit/s in the upstream, G.992.5 Annex L (RE-ADSL2+) with data transmission rates of 25 Mbit/s in the downstream and 1.0 Mbit/s in the upstream and G.992.5 Annex M (ADSL2+) with data transmission rates of 25 Mbit/s in the downstream and 3.5 Mbit/s in the upstream.
<b>G.993.1</b>	Data transmission recommendation for VDSL. Data transmission rates: 52 Mbit/s (downstream), 16 Mbit/s (upstream)
<b>G.993.2</b>	Data transmission recommendation for VDSL2. Data transmission rates: 200 Mbit/s (downstream), 200 Mbit/s (upstream)
<b>G.DMT</b>	See F.992.1.
<b>G.Lite</b>	See F.992.2.
<b>G.SHDSL</b>	See G.991.2.
<b>Gateway</b>	The gateway is a network component for connecting different types of network.
<b>GPRS</b>	General Packet Radio Service (GPRS) is the name for the packet-oriented service for transmitting data in GSM networks.
<b>GRE</b>	Generic Routing Encapsulation (GRE) is a network protocol for encapsulating other protocols so that they can be transported via the Internet Protocol (IP) in the form of a tunnel (VPN). GRE uses protocol number 47.
<b>GSM</b>	The Global System for Mobile Communications (GSM), also known as 2G, is a mobile communications standard. It achieves, along with GPRS, a specified max. data transmission rate of 171.2 kbit/s.
<b>Half-duplex</b>	With half-duplex, data can only be sent and received back-to-back over a line.
<b>Hands-free calling</b>	With hands-free calling, calls can be made without lifting the receiver. Other people in the room can participate in the conversation using a microphone and loudspeakers.

<b>Hash</b>	To ensure data integrity, the information needs to be protected from unauthorised manipulation while it is being transmitted. To ensure that this happens, every item of communication received has to match the information originally sent. Therefore erratic mathematical value functions (hash functions) are used to calculate checksums (hash values). These are encrypted and sent as a digital signature with the message. The recipient, in turn, checks the signature before opening the packet. If the signature and, thus, the content of the data packet has changed, the packet is discarded. The hash algorithms used most frequently are Message Digest Version 5 (MD5) and Secure Hash Algorithm (SHA1).
<b>HDSL</b>	High Data Rate Digital Subscriber Line. See DSL.
<b>Heartbeat</b>	A network's subscribers use heartbeats to signal that they are ready to receive.
<b>Hold</b>	A telephone call is put on hold without breaking the connection (inquiry/brokering). A distinction is drawn between holding the connection in the PBX (holding in the system) and holding in the switchboard or by the SIP provider.
<b>Hold for enquiry</b>	With hold for enquiry, the phone call with the first party is held while one conducts a second call.
<b>Hop</b>	Hop is the term for the connection from one network node to the next.
<b>Host</b>	A host is a computer system that provides its services to the network.
<b>Host name</b>	The domain name of a host. See DNS.
<b>Host route</b>	A host route is the name for the route to a single host.
<b>Hotspot</b>	A hotspot is a public internet access point via WLAN or wired Ethernet.
<b>HSDPA</b>	High Speed Downlink Packet Access (HSDPA, 3.5G, 3G+ or UMTS broadband) is a data transmission method in the UMTS mobile communications standard.
<b>HTTP</b>	The HyperText Transfer Protocol (HTTP) is a protocol for transmitting HTML pages (web pages) between server and client. By default it uses port 80.
<b>HTTPS</b>	The HyperText Transfer Protocol Secure (HTTPS) is a protocol

which protects against eavesdropping when transmitting HTML pages (web pages) between server and client. HTTPS is schematically identical to HTTP. SSL / TLS is used for additional data encryption. The standard port for HTTPS connections is 443.

<b>Hyperchannel</b>	With a hyperchannel, multiple subscribers have access to the transmission medium. A subscriber can only transmit their data if no other subscriber is using the medium. A hyperchannel network is mainly used for short-range operation with top data rates.
<b>IAE</b>	IAE refers to the standard socket (ISDN connection unit) to which ISDN terminals are connected.
<b>ICMP</b>	The Internet Control Message Protocol (ICMP) is used to exchange information and error messages over IPv4. The version ICMPv6 exists for IPv6.
<b>IGMP</b>	The Internet Group Management Protocol (IGMP) is used in IPv4 networks to organise multicast groups.
<b>IKE</b>	The Internet Key Exchange Protocol (IKE) is used for automatic key management with IPSec connections. The IKE process runs in two phases. During phase 1, the IKE subscribers authenticate themselves to one another and establish a secure channel. In phase 2, the two IPSec subscribers negotiate the SAs. There are two versions of the IKE mechanism.
<b>Infrastructure network</b>	In an infrastructure network the individual terminals (clients) form a wireless LAN via a central access point. This central access point may also be an agent in other networks.
<b>Internal call tone</b>	The internal call tone on a PBX is used to differentiate between internal and external calls.
<b>Internal telephone numbers</b>	Internal phone numbers are used for calls within the PBX.
<b>IP</b>	The Internet Protocol (IP) is a network protocol and it is the basis for the Internet. It works on the network layer of the OSI model. The TCP and UDP protocols are based on IP. There are two versions, Internet Protocol version 4 (IPv4) and Internet Protocol version 6 (IPv6).
<b>IP address</b>	IP addresses are used to navigate in an IP network, to unambiguously identify the source and destination. IPv4 addresses consist of 32 bits, IPv6 addresses of 128 bits. So, with IPv4 232, i.e.

4.294.967.296 addresses can be represented, with IPv6 2128 = 340.282.366.920.938.463.463.374.607.431.768.211.456 addresses. Dotted decimal notation, e. g. 192.168.0.250, is used for IPv4. Hexadecimal notation, e. g. 2001:db8:85a3::8a2e:370:7344, is used for IPv6. See also netmask.

<b>IPCP</b>	The Internet Protocol Control Protocol (IPCP) is used, in a similar way to DHCP, to configure a host with an IP address, gateway and DNS server, when a PPP network connection is being used. With the extension Robust Header Compression over PPP, the header can be compressed for faster data transmission. Similarly, in IPv6 networks, the functionality is provided by the Internet Protocol version 6 Control Protocol (IPV6CP).
<b>IPSec</b>	IPSec (Internet Protocol Security) is a network protocol for encapsulating other protocols so that they can be transported via the Internet Protocol (IP) in the form of a tunnel (VPN). The protocol number for IPSec depends on the protocol used. The Authentication Header (AH) uses protocol number 51, while the Encapsulating Security Payload (ESP) uses number 50.
<b>IPv6</b>	See IP.
<b>ISDN</b>	Integrated Services Digital Network (ISDN) is a data transmission standard that includes telephony, fax and data transmission. There are two ISDN connection variants: Basic Rate Interface and Primary Rate Interface.
<b>ISDN address</b>	The ISDN address of an ISDN device comprises an ISDN number followed by other numbers that relate to the specific terminal.
<b>ISDN login</b>	The ISDN login is used to remotely configure the device via SNMP. To do so, it needs to have a configured ISDN or wireless connection.
<b>ISDN number</b>	The ISDN number is the network address of the ISDN interface.
<b>ISDN router</b>	See Router.
<b>ISDN-BRI</b>	See BRI.
<b>ISDN-Internal/External</b>	Alternative name for the So bus.
<b>ISDN-PRI</b>	See PRI.
<b>ISP</b>	Internet Service Providers (ISPs) supply technical services for using

the Internet.

<b>ITU</b>	The International Telecommunication Union (ITU) coordinates the setting up and operating of telecommunications networks and services.
<b>Keepalive</b>	Keepalive packets are used to check that the communication partner can be contacted.
<b>Keepalive</b>	Keepalive is a mechanism for maintaining the network connection and for checking that the communication partner can be reached. Specific packets are usually sent to the network for this purpose.
<b>Keypad</b>	The keypad protocol (network direct) is used to access and manage performance features provided by the switchboard.
<b>L2TP</b>	The Layer 2 Tunneling Protocol (L2TP) is a network protocol for encapsulating other protocols so that they can be transported via the Internet Protocol (IP) in the form of a tunnel (VPN). By default, L2TP uses protocol number 1701. The architecture in an L2TP network consists of an L2TP access concentrator (LAC) which may also be permanently integrated into the client, and the L2TP network server (LNS). The LAC establishes the connections to the LNS and manages them. The authorisation is regulated using a network access server (NAS), which can be implemented in the LAC or LNS. The LNS is responsible for routing and controlling the packets received from the LAC. The user data itself is exchanged unencrypted, while control messages for maintaining the accessibility of the tunnel endpoints are transmitted securely.
<b>LAC</b>	See L2TP.
<b>LAN</b>	A Local Area Network (LAN) refers to a network that is geographically very limited and normally spans one building or a company head office.
<b>Layer</b>	A layer refers to a layer in the OSI model.
<b>LCP</b>	The Link Control Protocol (LCP) is used in PPP connections to automatically negotiate encapsulation, process limits for varying packet sizes, authenticate the connection partner, determine faulty links, identify connection faults and terminate the connection.
<b>LDAP</b>	The Lightweight Directory Access Protocol (LDAP) regulates the communication between a client and the directory server. LDAP is used for sharing and updating directories, e. g. a phone book.



<b>Lease time</b>	The lease time refers to the validity period of a dynamic IP address that a client has been given by a DHCP server.
<b>Leased line</b>	See Leased line
<b>Leased line</b>	A leased line is a permanent connection of two communication partners via telecommunications network.
<b>Line access authorisation</b>	See Exchange access right.
<b>LLC</b>	The Link Layer Control (LLC) regulates the media allocation at MAC level.
<b>LNS</b>	See L2TP.
<b>Load balancing</b>	With load balancing, data is sent via different interfaces in order to increase the overall bandwidth available. In contrast to Multilink, load balancing also functions with accounts with different providers.
<b>Loopback</b>	In a loopback switch the sender and recipient are identical.
<b>LTE</b>	Long Term Evolution (LTE), also known as 4G, is a mobile communications standard with a standardised maximum data transmission rate of 300 Mbit/s.
<b>MAC address</b>	The Media Access Control address (MAC address) is the hardware address of the network adapter and is used to identify the device at the hardware level.
<b>Main Mode</b>	When establishing an IPSec connection, main mode is used to implement a phase 1 exchange by setting up a secure channel. See also Aggressive mode.
<b>Man-in-the-Middle attack</b>	In a Man-in-the-Middle attack, the attacker is physically or logically between the two communication partners and so is able to view, and even manipulate, the data traffic.
<b>MD5</b>	Message Digest Algorithm 5 (MD5) is a hash function that generates a 128 bit hash value (checksum). See also Hash.
<b>Media gateway</b>	A media gateway converts the network type of digital voice, audio or image information. For example, the signals from an ISDN network can be converted to an IP network.
<b>Metric</b>	The metric is a measure for the properties of the route. The fastest route has the lowest metric (costs). Simplified, this is connecting

with the smallest number of node points (routers).

<b>MFC</b>	See Multifrequency code dialling method.
<b>MFV</b>	See Multifrequency code dialling method.
<b>MIB</b>	The Management Information Base (MIB) describes the data that can be queried or modified via a network management protocol (e. g. SNMP). The MIB is a database that describes all the devices and functions in the network.
<b>MLP</b>	The Multicast Listener Discovery (MLD) is used in IPv6 networks to organise multicast groups.
<b>Mobile subscriber</b>	If the mobile subscriber is enabled, an external telephone, e. g. a mobile phone can be called in parallel (parallel calling). The system's functions, e. g. callback, can also be used externally. For these functions, the external telephone's star key is interpreted as the R key.
<b>Modem</b>	A modem is an electronic device that converts digital signals to frequency signals in order to distribute data in a wired or wireless network.
<b>MOH</b>	See Music on hold.
<b>MPDU</b>	The MAC Protocol Data Unit (MPDU) refers to a data packet, including management frames and fragmented MSDUs, exchanged wirelessly.
<b>MPPC</b>	Microsoft Point-to-Point Compression (MPPC) is a method of data compression.
<b>MPPE</b>	Microsoft Point-To-Point Encryption (MPPE) is used to encrypt data transmitted via PPP. It was developed by Microsoft and Cisco and specified as RFC 3078.
<b>MS-CHAP</b>	The Microsoft Challenge Handshake Authentication Protocol (MS-CHAP) is a method of authentication. MS-CHAPv1 is intended for authenticating DCN connections and is largely the same as the standard CHAP. MS-CHAPv2 is an authentication method for PPTP connections (VPN).
<b>MSDU</b>	A MAC Service Data Unit (MSDU) is a data packet that is exchanged at LLC level.
<b>MSN</b>	See Multiple subscriber number

<b>MSS</b>	The Maximum Segment Size (MSS) defines the maximum number of bytes that can be used as user data in a TCP segment. The MSS must be smaller than the Maximum Transmission Unit (MTU) to avoid fragmenting the IP packets.
<b>MSS clamping</b>	MSS clamping reduces the Maximum Segment Size (MSS) in order to connect networks with different Maximum Transmission Units (MTU).
<b>MTU</b>	The Maximum Transmission Unit (MTU) is the largest possible data unit that can be transmitted over a physical line.
<b>Multicast</b>	With a multicast, data packets are sent from one point to particular subscribers in a network. In IPv4 this is controlled via the address range 224.0.0.0 to 239.255.255.255 and the IGMP protocol, while in IPv6 it is controlled by ff00::/8 addresses and ICMPv6.
<b>Multifrequency code dialling method</b>	The multifrequency code dialling method, also known as tone dialling, MFV, MFC and DTMF, is a signalling method for automatic telephone routing. Key inputs are represented by overlaid, sinusoidal signals. See also Pulse dialling.
<b>Multilink</b>	With multilink, multiple interfaces (PPP, PPPoE, ...) are combined into a single virtual connection in order to increase the total bandwidth available.
<b>Multiple subscriber number</b>	Multiple subscriber numbers are the individual phone numbers in the ISDN point-to-multipoint connection.
<b>Music on Hold</b>	The term Music On Hold (MOH) refers to automated announcements or hold music on the PBX.
<b>Music on hold</b>	See Music on hold.
<b>MWI</b>	The Message Waiting Indicator (MWI) signals that a new message is available.
<b>NAPT</b>	Network Address Port Translation (NAPT) is another term for PAT. See PAT.
<b>NAT</b>	Network Address Translation (NAT) is used to replace the source and destination IP addresses of a data packet with others. This enables different networks to be connected to one another. See also PAT.
<b>NBNS</b>	Like DNS, NetBIOS Name Service (NBSN) is used in centralised name resolution. See also WINS and DNS.

<b>Netmask</b>	With IPv4 in connection with the IP address, the netmask, also network mask and subnet mask, defines the network by dividing the IP address into network and device parts and thus determining which addresses need to be routed. Example of a netmask: 255.255.255.0. With IPv6 one refers to prefix length.
<b>Network address</b>	A network address is the address of the network as a whole. The network mask and prefix length divide the IP address into the network address and host address (device address). Example of a network address: 192.168.0.250/24
<b>Network direct</b>	See Keypad.
<b>Network route</b>	The network route refers to the route to a particular network.
<b>Network termination</b>	Network termination (NT) refers to a connection or operating type. A terminal is given access to a communication network at the NT interface (connection socket). The connector is called a TAE with an analogue connection, an NTBA with the basic ISDN connection, and NTPMGF with the ISDN Primary Rate Interface. In the NT operation, the gateway is connected to the PABX's external S0 and is an external exchange connection for it. See also TE.
<b>NT</b>	See Network termination.
<b>NTBA</b>	See Network termination.
<b>NTP</b>	The Network Time Protocol (NTP) is used to synchronise the time of day.
<b>NTPMGF</b>	See Network termination.
<b>OAM</b>	OAM is a service for monitoring ATM connections.
<b>Open hold for enquiry</b>	With open hold for enquiry, a call is put on hold and either party can then resume it once more.
<b>OSI model</b>	The OSI model divides the flow of communication between the physical medium and the user level into layers. The requirements at each layer are met by relevant protocols.
<b>OSPF</b>	OSPF is a dynamic routing protocol which is usually used in larger network installations as an alternative to RIP.
<b>PABX</b>	Private Automatic Branch Exchange (PABX) is another expression for a telephone system.

<b>PABX</b>	PABX is another term for a telephone system.
<b>PAP</b>	The Password Authentication Protocol (PAP) is an authentication method for connections via PPP. Unlike with CHAP, the username and password are not sent encrypted.
<b>Parallel call</b>	See Mobile subscriber.
<b>Park</b>	When a call is parked, the connection is held even if the receiver of the terminal involved is replaced or the cable connection is cut off.
<b>PAT</b>	Port and Address Translation (NAT) is used to replace the source and destination IP addresses and source and destination ports of a data packet with others. This enables different networks to be connected to one another. See also NAT.
<b>PBX</b>	Private Branch Exchange (PABX) is another expression for a telephone system.
<b>PDM</b>	See Pulse dialling
<b>Peer</b>	A peer is the endpoint of a communication in the network.
<b>Phase 1/2</b>	See IKE.
<b>Pick-up</b>	With pick-up, calls can be received using code procedures on an internal terminal that is not part of active call allocation.
<b>PIM</b>	The Protocol Independent Multicast (PIM) enables the dynamic routing of multicast packets on the Internet.
<b>PIN</b>	A personal identification number (PIN) can be used to authenticate oneself on the device so that one can use the device's functions.
<b>Ping</b>	Ping is a diagnostic tool that can be used to check whether a particular host in an IP network can be contacted. A measurement is taken of the time interval between sending a data packet (ICMP(v6) echo request packet) and receiving a response packet sent back immediately. This enables the connection quality to be determined.
<b>PKCS</b>	The Public-Key Cryptography Standards (PKCS) are standards for public key cryptography. The PKCS are designed for binary and ASCII data and are compatible with the X.509 standard. The public standards are PKCS #1, #3, #5, #7, #8, #9, #10, #11, #12 and #15. PKCS #10 describes the syntax for certification inquiries.
<b>PKI</b>	A public key infrastructure (PKI) is used to issue, distribute and veri-

fy digital certificates for an encryption procedure.

<b>PMTU</b>	The Path MTU (PMTU) describes the maximum packet size that can be transmitted along the entire connection route without needing to be fragmented.
<b>Point-to-multipoint</b>	Point-to-multipoint connection is an ISDNB connection. It is used to connect ISDN terminals. Multiple subscriber numbers (MSNs) are provided. See also Point-to-point ISDN access
<b>Point-to-multipoint</b>	See Single phone number (VoIP).
<b>Point-to-point</b>	See Point-to-point ISDN access and Direct dial-in (VoIP).
<b>Point-to-point connection number:</b>	See Point-to-point ISDN access
<b>Point-to-point ISDN access</b>	Point-to-point ISDN access refers to an ISDN connection that is also called point-to-point. It is used to connect a PBX. A point-to-point number and a number block are issued. Each of the numbers in the number block is called a direct dial exception. (Example: Point-to-point connection number: 1234, number block: 1 - 99, numbers of the individual extensions: 1234-1, 1234-2, 1234-3, ...) See also Point-to-multipoint connection.
<b>Pool</b>	An address pool is a collection of IP addresses that can be assigned to the connected clients, e. g. by DHCP.
<b>POP3</b>	The Post Office Protocol Version 3 (POP3) is a transmission protocol which controls how a client accesses emails from an email server.
<b>Port</b>	The port number is used to decide the service (telnet, FTP, ...) to which an incoming data packet should be sent.
<b>POTS</b>	Plain Old Telephone System (POTS) refers to the analogue telephone network.
<b>PPP</b>	The Point-to-Point Protocol (PPP) is a standardised technology for setting up a direct connection between the network nodes via dial-up lines.
<b>PPPoA</b>	The Point-to-Point-over-ATM Protocol (PPPoA) enables PPP data packets to be transported directly over an ATM network.
<b>PPPoE</b>	The Point-to-Point-over-Ethernet Protocol (PPPoE) enables PPP data packets to be transported directly over an Ethernet network.

<b>PPTP</b>	The Point-to-Point Tunneling Protocol (PPTP) is a network protocol for encapsulating other protocols so that they can be transported via the Internet Protocol (IP) in the form of a tunnel (VPN). PPTP uses protocol number 1723. The PPTP architecture is divided into two logical systems. The PPTP Access Concentrator (PAC) and the PPTP Network Server (PNS). The PAC is usually integrated into the Windows client. It establishes the connection to the PNS and manages it. The PNS is responsible for routing and controlling the packets received by the PNS.
<b>Pre-shared key</b>	A pre-shared key (PSK) is a key for an encryption procedure. The parties shared the key's value beforehand.
<b>Prefix</b>	See Network address
<b>Prefix delegation</b>	In IPv6 networks, prefix delegation is used to assign the network address (prefix) to the router.
<b>Prefix length</b>	See netmask.
<b>PRI</b>	See Primary Rate Interface.
<b>Primary Rate Interface</b>	The Primary Rate Interface is a network connection to the ISDN. This type of connection is often also called a PRI or S2Minterface. A Primary Rate Interface offers 30 user channels (B channels), each with 64 kbits/s, in Europe and 23 in the USA, one control channel (D channel) with 64 kbits/s and one synchronisation channel with 64 kbits/s in Europe and 8 64 kbits/s in the USA. See also Basic Rate Interface.
<b>Proposal</b>	When an IPsec connection is being established, the initiator of the connection makes proposals with relation to the authentication and encryption methods to be used.
<b>Protocol</b>	Protocols regulate the flow of a data communication on different levels of the OSI model. Protocols control addressing, coding, authentication, formatting, etc. Examples: Ethernet, IP, TCP, HTTP
<b>Proxy</b>	A proxy is a network component. The proxy is an agent. It routes a query from the source with its own IP address to the destination.
<b>Pulse dialling</b>	Pulse dialling is a signalling method for automated telephone routing. Key inputs are represented by a defined number of dc pulses. See also Multifrequency code dialling method (MF).
<b>PVID</b>	The Port VLAN Identifier (PVID) is the standard VLAN ID for the port concerned. A packet that reaches this port without a VLAN tag is as-

	signed this ID.
<b>Q-SIG</b>	Q-Interface Signalling Protocol (Q-SIG) is an ISDN-based signalling protocol for linking PABX systems.
<b>QoS</b>	Quality of Service (QoS) describes the properties of the communication service. It is defined using bandwidth, delay, packet losses and jitter. To transmit time-critical data packets for VoIP or video streaming as quickly as possible, QoS is used to sort all the data packets into groups and forward them on in the network either more quickly or slowly, depending on their priority.
<b>Queue</b>	The data packets accumulate in a queue before they are sent.
<b>RADIUS</b>	Remote Authentication Dial-In User Service (RADIUS) is a client-server protocol for authenticating, authorising and accounting for users with dial-in connections. The RADIUS server authenticates the client, e. g. by checking the username and password. See also TACACS+.
<b>RE-ADSL2</b>	See G.992.5.
<b>Real Time Jitter Control</b>	Real Time Jitter Control is used, where necessary, to reduce the size of data packets during a telephone conversation so that voice packets are not blocked.
<b>Registrar</b>	The SIP server (registrar) needs to be used in case the subscribers to a VoIP call are not using static IP addresses. The SIP server registers the clients' IP addresses and sends this data to the SIP proxy, which connects the calls. The SIP proxy and SIP registrar are usually identical.
<b>Reject / reject function</b>	When a phone number that has not been set up in the telephone system is dialled, or if the connection of the party called is engaged, or the party called does not take the call, the reject function determines how to proceed with the call. The call can be routed to a different destination or discarded.
<b>Repeater</b>	A repeater is a device that strengthens electric or optical signals and thus increases the range of the network.
<b>Reset</b>	This returns the device to its unconfigured state.
<b>RFC</b>	A Request For Comments (RFC) is a document that describes the standards and guidelines for the Internet.
<b>Rijndael</b>	See AES.



<b>RIP</b>	The Routing Information Protocol (RIP) is a routing protocol. It is restricted to small networks. See also OSPF.
<b>RipeMD 160</b>	RACE Integrity Primitives Evaluation Message Digest (RipeMD 160) is a hash function that generates a 160 bit hash value (checksum). See also Hash.
<b>RJ45</b>	RJ45 refers to a jack or connector with a maximum of eight wires to the digital terminals' connection.
<b>Roaming</b>	With roaming, a client moves through a WLAN logging on and off at different access points in the same network.
<b>Room monitoring</b>	Room monitoring is a performance feature. One can listen in to the sounds in a room.
<b>Router</b>	A router is a network component for connecting different types of network at the network layer of the OSI model. Data packets are transmitted using IP addresses. Routing tables are used to identify the best routes through the network. In order to keep the routing tables up to date, the routers exchange information via routing protocols (e.g. OSPF, RIP).
<b>Router advertisement</b>	Router advertisements are messages that the router sends to the network. They announce the presence of the router in the network. Router announcements are also used to issue prefixes, organise the autoconfiguration and specify the standard router.
<b>Routing</b>	Routing refers to the identifying of routes for sending messages.
<b>RSA</b>	The RSA algorithm (named after its inventors, Rivest, Shamir and Adleman) is used to create digital signatures and encrypt data packets. The signature can be used to verify changes made to the information in the data packet. RSA is used for public-key cryptography (IPSec). See also DSA. Key generation is slower with RSA than with DSA, but key processing is faster.
<b>RTP</b>	The Real-Time Transport Protocol (RTP) is used to transmit audio and video data (streams) via IP-based networks.
<b>RTS threshold</b>	Once the number of frames in the data packet exceeds the RTS threshold, a connection check (RTS/CTS handshake) is run before a data packet is sent.
<b>RTSP</b>	The Real-Time Streaming Protocol (RTSP) controls the transmission of audio and video data (streams) via IP-based networks. While the Real-Time Transport Protocol (RTP) is used to transmit user

data, the main function of RTSP lies in controlling the data streams.

<b>Rule chain</b>	A rule chain contains a combination of different filter rules. A filter rule selects part of the data traffic based on particular features, e. g. the source IP address, and applies an action, e. g. block, on this part.
<b>S0 bus</b>	The S0 bus is an interface for the ISDN Basic Rate Interface, and links multiple ISDN terminals to the NTBA. The bus is implemented by a four-wire circuit. See also UP0.
<b>S2M interface</b>	See Primary Rate Interface.
<b>SA</b>	So-called security associations (SA) receive information about the measures to secure the communication connection. One SA, at least, is a prerequisite for establishing a secure connection. An SA receives the subscriber's IP address, the authentication protocol used, the encryption algorithm used, the security parameter index (SPI), the selector and the period of validity.
<b>SAD</b>	All the parameters that are set while configuring IPsec are stored in the router in the form of databases. These are the Security Policy Database (SPD) and the Security Association Database (SAD). The SAD receives information about every security connection. That is, which encryption algorithms, keys, protocols, session numbers or periods of validity are to be used. For an outgoing connection, an SPD entry displays an SAD entry. In this way, the SPD can specify which SA is to be used for a particular packet. With an incoming connection, the SAD is addressed in order to specify how the packet is to be processed.
<b>SCEP</b>	The Simple Certificate Enrollment Protocol (SCEP) is used to manage digital certificates.
<b>Scheduling</b>	Scheduling refers to the planning of tasks. Particular actions (e. g. deactivating an interface) are triggered by events (e. g. time or changing a MIB variable).
<b>Serial interface</b>	The serial interface is used to exchange data between computers and peripheral devices. It can be used to configure the device or to transmit data via an IP infrastructure (Serial over IP).
<b>Server</b>	A server offers services used by clients.
<b>SFP</b>	Small Form-factor Pluggable (SFP) is a plug-in connector that was developed for extremely fast Ethernet.

<b>SHA1</b>	Secure Hash Algorithm version 1 (SHA1) is a hash function that generates a 160 bit hash value (checksum). See also Hash.
<b>SHDSL</b>	Symmetrical High-bit-rate Digital Subscriber Line. See DSL.
<b>Shell</b>	The shell is an input interface (e. g. command line or graphic user interface) between computer and user.
<b>Short hold</b>	The short hold is the defined amount of time after which a network connection is automatically cleared if no more data is transmitted.
<b>SIF</b>	With a Stateful Inspection Firewall (SIF), the routing of a data packet is not determined only by source and destination addresses but also using dynamic packet filtering based on the connection status.
<b>Simplex operation</b>	Simplex operation is a performance feature. Simplex operations are used to take a call automatically and switch the speaker function on. If the called party lifts the receiver, a normal voice connection is established.
<b>Single phone number (VoIP)</b>	Single phone number access is a VoIP connection that is also known as a point-to-multipoint connection. It is used to connect VoIP terminals. Multiple subscriber numbers (MSNs) are provided. See also Direct dial-in (VoIP)
<b>SIP</b>	The Session Initiation Protocol is a network protocol for setting up a communication session between two or more subscribers. The protocol is used for IP telephony (VoIP).
<b>SIP provider</b>	A SIP provider does the switching between a SIP connection and other analogue, ISDN and VoIP connections.
<b>SMTP</b>	The Simple Mail Transfer Protocol (SMTP) is used to exchange emails.
<b>SNMP</b>	The Simple Network Management Protocol (SNMP) is used to configure, control and monitor different network components (e. g. routers, servers, etc.) from a single, central system. The network component settings that can be changed are stored in a database – the Management Information Base (MIB). SNMP uses UDP. The network component receives requests to port 161 while the managing system receives confirmation messages (TRAPs) at port 162.
<b>SNTP</b>	The Simple Network Time Protocol (SNTP) is used to transmit the time and to synchronise the server and client.
<b>Softkey</b>	A softkey refers to a key whose function is determined by the asso-

ciated screen display.

- Spatial streams** Spatial streams are data streams that are sent out at the same time on the same frequency in the wireless LAN. The transmission rate is multiplied as a result.
- SPD** All the parameters that are set while configuring IPSec are stored in the router in the form of databases. These are the Security Policy Database (SPD) and the Security Association Database (SAD). The Security Policy Database lists the forms of data traffic that are to be secured. Factors such as the source and destination address of the data packet are used to do this.
- Speaker function** With the speaker function, the people present in the room can listen in to the telephone call.
- Speed dial number** A speed dial index (000...999) is assigned to every number in the phone book. This speed dial index can be used to dial instead of the long phone number.
- Splitter** A broadband access unit, commonly known as a splitter, is used to split signals that come via a subscriber loop into data and telephone lines.
- SRTP** The Secure Real-Time Transport Protocol (SRTP) is the variant of the Real-Time Transport Protocol (RTP) that is encrypted using AES.
- SSH** Secure Shell (SSH) is a network protocol that can be used to establish an encrypted connection to a device's shell.
- SSID** The Service Set Identifier (SSID) defines a wireless network that is based on IEEE 802.11. The SSID is the network name of the wireless LAN. All the access points and clients that belong to the same network use the same SSID. The SSID string can be up to 32 characters long and is placed, unencrypted, in front of all packets. A client uses SSID ANY to contact all the accessible access points. The user is then shown all the available WLANs and he can select the appropriate network. If an access point is used for different networks, each wireless network is given a separate MSSID (Multi Service Set Identifier).
- SSL** Secure Sockets Layer (SSL) is a protocol for data encryption. Since version 3.1, the new term Transport Layer Security (TLS) has been used. SSL is mainly used for HTTPS to encrypt the data transmission between web server and web browser.

<b>STAC</b>	STAC is used to reduce the data volume transmitted (data compression).
<b>Static IP Address</b>	In contrast to a dynamic IP address, the static IP address is assigned permanently by the user. Network components such as the web server or printer usually have static IP address, while clients such as notebooks or workstations usually have dynamic IP addresses.
<b>Station guarding</b>	When station guarding is enabled, acoustic call signalling is switched off. This function is also known as Do not disturb.
<b>STUN Server</b>	Simple Traversal of User Datagram Protocol (UDP) Through Network Address Translators (NATs). A STUN server enables VoIP devices behind an active NAT to access the network.
<b>Sub-addressing</b>	As well as the ISDN telephone number, a sub-address can also be sent when establishing the connection. This sub-address can transmit any additional information. It can be used, e. g., to systematically address multiple ISDN terminals that can be reached under one telephone number, or to open particular programs on a PC.
<b>Subnet</b>	A sub-network in an IP network is known as a subnet. A subnet is defined like a normal network, via an IP address and (sub-)netmask (IPv4) and prefix length (IPv6). Example: 192.168.1.250/24 (192.168.1.250/255.255.255.0, 256 possible IP addresses) is a subnet of 192.168.1.250/16 (192.168.1.250/255.255.0.0, 65536 possible IP addresses).
<b>Suppress telephone number</b>	See Display caller number (CLIP / CLIR) and Display called party number (COLP / COLR).
<b>Switch</b>	A switch is a network component that connects individual network segments to one another. On the one hand, a switch can be operated as a bridge to the data link layer in the OSI model. Unlike the bridge, however, a switch has more than one input and output. On the other hand, the switch can be operated as a gateway to the network layer in the OSI model. The device comparable to the switch in the physical layer is known as the hub.
<b>Switch contact</b>	A telephone can be used to switch a device connected to the switch contact, e. g. a door opener, on and off.
<b>SWYX</b>	SwyxWare is a software-based communication solution for VoIP.
<b>Syslog</b>	The syslog protocol is used to transmit status messages in an IP

network. In this way, different network components can be monitored from a single, central system. Syslog messages are sent as unencrypted text messages over the UDP port 514.

<b>System telephone</b>	A system telephone has multiple function and special keys and can use the performance features of a PBX.
<b>T.38</b>	T.38 or Fax over IP (FoIP) refers to fax transmission via an IP network.
<b>TA</b>	See Terminal adapter
<b>TACACS+</b>	The Terminal Access Controller Access Control System Plus (TACACS+) is a client-server protocol for authenticating, authorising and accounting for users. The TACACS+ server authenticates the client by checking, e. g., the username and password. In contrast to the UDP-based RADIUS protocol, TACACS+ uses TCP on port 49 and transmits the entire communication encrypted.
<b>TAPI</b>	The Telephony Applications Programming Interface (TAPI) is a programming interface for ISDN. It enables application programs to access ISDN hardware from a PC. See also CAPI.
<b>TCP</b>	The Transmission Control Protocol (TCP) is a connection-oriented protocol. It works on the transport layer of the OSI model. With a connection-oriented protocol, a logical connection is established before transmission and maintained. This enables data to be transmitted reliably. Nonetheless, control information is constantly being sent alongside the actual data packets. This causes the data volume sent to increase. See also UDP.
<b>TCP-ACK packet</b>	An ACK (acknowledgement) signal is used when transmitting data to confirm the receipt or the processing of data or commands. TCP uses ACK signals for communication.
<b>TCU</b>	See Network termination. A distinction is drawn between F-coded connectors for telephones and N-coded connectors for fax machines, modems and answering machines.
<b>TE</b>	Terminal equipment (TE) refers to a connection or operating type. The TE connector is a terminal's connector. In TE operation, the gateway is connected to the PABX's internal S0 and thus constitutes an ISDN terminal. See also NT.
<b>TEI</b>	Under ISDN protocol DSS1, the Terminal Endpoint Identifier (TEI) is an identifier for terminals.

<b>Telefax</b>	See Fax.
<b>Telnet</b>	Telecommunication Network (Telnet) is a network protocol. It enables communication with another, remote device in the network, e. g. PCs, routers, etc.
<b>Terminal adapter</b>	A terminal adapter (TA) can be used to connect terminals to an interface on which they cannot be operated directly, e. g. analogue terminals to an ISDN connection.
<b>TFTP</b>	The Trivial File Transfer Protocol (TFTP) regulates the transmission of files. Compared with FTP, there is no option to display data, issue permissions or authenticate users.
<b>Three-party conference</b>	The three-party conference is a performance feature. Three subscribers can speak to one another on the phone simultaneously.
<b>Tiger 192</b>	Tiger 192 is a hash function that generates a 192 bit hash value (checksum). See also Hash.
<b>Time service</b>	The Time protocol is used to synchronise the date and time. The protocol uses port 37 via TCP and UDP.
<b>Time slot</b>	A time slot is a period of time which is permanently assigned within a transmission frame, and is usually equivalent to one transmission channel.
<b>TLS</b>	See SSL.
<b>Tone dialling</b>	See Multifrequency code dialling method.
<b>TOS</b>	Type of Service (TOS) is a field in the header of IP data packets. It specifies the priority of the data packet. See also QoS.
<b>Traceroute</b>	Traceroute is used to determine which routers will be used to route data packets to the queried destination host.
<b>Trigger</b>	This refers to a trigger impulse.
<b>Triple DES</b>	See DES.
<b>Trunk</b>	A trunk consists of bundled connections or transmission channels. See also Bundle.
<b>TTL</b>	The Time to live (TTL) is the configured period of validity of a data packet. With the Internet Protocol (IP), TTL specifies how many hops a data packet may pass. The maximum value is 255 hops. The

	<p>TTL is reduced by 1 with each hop. If a data packet has not yet reached its destination when its TTL expires, it is discarded.</p>
<b>Twofish</b>	<p>Twofish is an encryption method (see Cipher). Twofish uses a fixed block length of 128 bits. The key length is 128, 192 or 256 bits.</p>
<b>U-ADSL</b>	<p>Universal Asymmetric Digital Subscriber Line (UADSL) is a DSL variant. It was developed as ANSI T1.413 and standardised as G.992.2. U-ADSL enables different communication technologies to be used in parallel, e. g. ISDN and POTS, and does not require a splitter.</p>
<b>UDP</b>	<p>The User Datagram Protocol (UDP) is a connectionless protocol. It works on the transport layer of the OSI model. With a connectionless protocol, no control is integrated for delivering the packet. The control must take place in the application layer. Conversely, UDP is faster than connection-oriented protocols.</p>
<b>ULA</b>	<p>Unique Local Addresses (ULA) are IPv6 addresses that are not routed. They can be used in private networks (e. g. a LAN). ULAs begin with the prefix fd.</p>
<b>UMTS</b>	<p>The Universal Mobile Telecommunications System (UMTS), also known as 3G, is a mobile communications standard with a specified max. data transmission rate of 384 kbit/s and 21 Mbit/s in association with HSPA+.</p>
<b>Unicast</b>	<p>With Unicast, data packets are transmitted from a sender to a single recipient.</p>
<b>UP0</b>	<p>The UP0 connection is an interface for the ISDN Basic Rate Interface, and links one ISDN terminal to the NTBA. The connection is implemented via a two-wire circuit, and offers a greater range than the S0 bus.</p>
<b>UPnP</b>	<p>Universal Plug and Play (UPnP) is used to control devices (audio devices, routers, printers, etc.) from any manufacturer via an IP-based network.</p>
<b>Upstream</b>	<p>The gateway forwards the data from its own network.</p>
<b>URL</b>	<p>A Uniform Resource Locator (URL) identifies a file's storage location. Example: <a href="http://www.example.org/index.htm">http://www.example.org/index.htm</a> (Internet website)</p>
<b>UUS</b>	<p>With User to User Signalling (USS), text messages can be exchanged with other subscribers.</p>



<b>V.110</b>	V.110 describes a method of aligning bitstreams with 0.6, 1.2, 2.4, 2.8, 7.2, 9.6, 12, 14.4, 19.2 and 38.4 kbit/s with the ISDN bitstream of 64 kbit/s.
<b>VDSL</b>	Very High Speed Digital Subscriber Line. See DSL.
<b>VID</b>	See VLAN.
<b>VLAN</b>	A network can be divided up into one or more logical sub-networks—so-called Virtual Local Area Networks (VLAN) – by the network components no longer forwarding the data packet of a defined sub-network to other sub-networks. Each VLAN is assigned a unique number, This number is called a VLAN ID (VID) and assigned to the data packets in the VLAN tag.
<b>Voice mailbox</b>	A voice mailbox is a user's personal answering machine in a voice-mail system.
<b>Voicemail system</b>	A voicemail system enables voice messages to be stored, accessed and forwarded, like an answering machine, but with more options.
<b>VoIP</b>	Voice over IP (VoIP), also known as IP telephony, refers to the transmitting of voice via an IP network. The telephone is connected and disconnected using signalling protocols, e. g. SIP.
<b>VPN</b>	A virtual private network (VPN) is used to transport private data packets through a public network. The data is separated from the publicly accessible data by being encapsulated in new protocols so that they can be routed to the intended recipient. In this context, one also refers to a tunnel that is established between the private networks of the two connected parties. VPN protocols are IPSec, PPTP, L2TP and GRE.
<b>VSS</b>	The Virtual Service Set (VSS) refers to a prefix for wireless LAN interfaces.
<b>Walled garden</b>	In the context of hotspots, a walled garden refers to the area of the website which is available to users free of charge and without logging in.
<b>WAN</b>	A Wide Area Network (WAN) refers to a network that is spread over a large geographic area. Global WAN networks provide access to the Internet.
<b>WDS</b>	The Wireless Distribution System (WDS) is used to establish a wireless connection between access points.

<b>Web server</b>	A web server provides HTML documents (web pages).
<b>WEP</b>	Wired Equivalent Privacy (WEP) is an encryption protocol for WLANs. The key length is 40 or 104 bits.
<b>WINS</b>	The Windows Internet Name Service (WINS) is a translation of the NetBIOS over TCP/IP network protocol by Microsoft. Like DNS, WINS is used for centralised name resolution. See also DNS.
<b>WLAN</b>	Wireless Local Area Network (Wireless LAN, WLAN) refers to a local wireless network based on the 802.11 standard.
<b>WMM</b>	Wi-Fi Multimedia (WMM) prioritises the data packets from different applications, thus improving the transmission of voice, music and video data in WLAN networks. To do this, WMM provides quality-of-service features (QoS) for IEEE 802.11-based networks.
<b>WPA</b>	Wi-Fi-Protected Access (WPA) is an encryption protocol for WLANs. WPA uses dynamic keys that are based on the Temporal Key Integrity Protocol (TKIP).
<b>WPA 2</b>	Wi-Fi Protected Access (WPA) is an encryption protocol for WLANs. WPA 2 uses AES.
<b>WPA Enterprise</b>	With WPA 1 / 2, WPA Enterprise enables subscribers to be authenticated using the Extensible Authentication Protocol (EAP). After successful authentication, the server transfers a shared key to the client and the access point for data transfer in the WLAN.
<b>WPA-PSK</b>	With WPA 1 / 2, WPA-PSK enables subscribers to be authenticated using pre-shared keys. The access point and the client use the same string for the key calculation in the WLAN. This string needs to be configured by the users.
<b>X.25</b>	X.25 is a standardised series of protocols for wide area networks (WANs) via the telephone network.
<b>X.31</b>	The X.31 standard describes the connecting of ISDN and X.25 systems. It is a standard for connecting card terminals.
<b>X.500</b>	The X.500 standard describes the setting up of a directory service. See also LDAP.
<b>X.509</b>	The X.509 standard describes the generating of certificates for a public key infrastructure (PKI).
<b>X.75</b>	X.75 is a standardised series of protocols for ISDN networks with a

transmission rate of 64 kbit/s.

**XAuth**

XAUTH (Extended Authentication) is used to add further authentication mechanisms to IKE. After a successful phase 1 authentication, the user can be separately identified again. The identifying is done using the username and password, PAP, CHAP or hardware-based systems.

**Zone**

A zone refers to a phone number or numbers that begin with the same sequence.

## Index

- Automatic Call Pick-up 181 , 610
- Description 94
- Interface 63
- Internal MSN 193
- Internal Number 181 , 193
- Key 178 , 186 , 191 , 195 , 607 , 614
- Key name 181 , 186 , 193 , 195 , 610 , 614
- Key Type 178 , 181 , 186 , 191 , 193 , 195 , 607 , 610 , 614
- Label Description 178 , 191 , 607
- Module 186 , 195 , 614
- Number 181 , 193 , 610 , 610
- Number of Boss Phone 181 , 610
- Number of Secretary Phone 181 , 610
- Phone 186 , 195 , 614
- Pick-Up Code 193
- Settings 178 , 186 , 191 , 195 , 607 , 614
- Target Number "Immediate" 181 , 610
- Target Number "On busy" 181 , 610
- Target Number "On no reply" 181 , 610
- Team 181 , 610
- Trunk Group Access 610
- Trunk Group Access 181
- Trunk Line 181 , 610
- URL 193
- Waiting Queue 181 , 193 , 610
- Accept Client FQDN 508
- Accept Router Advertisement 280 , 388 , 398
- Access 509
- Access Configuration 109
- Access Control 315
- Access Filter 374
- Access Level 76
- Access Type 90 , 93 , 126
- Action 339 , 374 , 462 , 465 , 517 , 547
- Action to be performed 532
- Active Doorcom Variant 267
- Active Function 595 , 596 , 597 , 598
- Active Radio Profile 303
- Active Variant 262
- Active Variant (Day) 138 , 157 , 164 , 577
- Additional freely accessible Domain Names 540
- Additional Info for Extern Call 143
- Additional IPv4 Traffic Filter 431 , 433
- Address assignment 505
- Address / Prefix 469
- Address / Subnet 469
- Address Mode 280 , 415
- Address Range 469
- Address Type 469
- Addresses 119
- Admin Password 195 , 200
- Admin Status 351
- Administrative FQDNs 508
- Administrative Status 427 , 483
- Advertise 283
- Airtime fairness 306
- Alert Service 569
- Alive Check 71 , 447 , 452
- All Multicast Groups 383
- Allow manual trunk group selection 141
- Allowed Addresses 315
- Allowed HotSpot Client 542
- Always on 385 , 391 , 396 , 401 , 408
- Announcement 245
- Answering Machine 186 , 615
- APN 497
- Application 240
- ARP Processing 311
- Assigned Users 578
- Assigned Wireless Network (VSS) 303
- Assignment 159 , 163 , 248 , 268
- ATM Interface 413
- ATM PVC 396
- ATM Service Category 418
- Authentication 389 , 393 , 399 , 403 ,

- 410
- Authentication ID 109
- Authentication Method 427 , 442
- Authentication Type 69
- Authorization 165
- Auto Attendant with DISA 246
- Auto Subnet Configuration 283
- Automatic Call Pick-up 175 , 603
- Automatic Call Pick-up 576 , 577
- Automatic Call Pick-up with 160 , 262
- Automatic Outside Line 141
- Automatic Route Selection (ARS) 143
- Autonomous Flag 285
- Autosave Mode 84 , 517
- Bandwidth 305
- Based on Ethernet Interface 279
- Beacon Period 308
- Bell ID 267
- Bell Name 267
- Blacklist blocktime 315
- Block after connection failure for 389 ,  
393 , 399 , 403 , 410
- Block Time 447
- Burst size 366
- Busy on busy 136 , 160 , 577
- Busy starting with 162
- Busy when 262
- CA Certificate 80
- CA Certificates 447
- CA Name 517
- Calendar for status "Out of Office"  
271
- Call Center Description 261
- Call Forwarding 576 , 577
- Call Forwarding extern (SIP 302) 113
- Call Forwarding to External Numbers  
157
- Call Hold inside the PBX system 113 ,  
128
- Call Number 406
- Call Signalisation Timer 268
- Call Switching 246
- Call Through 140 , 147 , 252
- Call Waiting 147 , 172 , 225 , 576 ,  
602
- Call-prefix 236
- Callback Mode 403
- CAPWAP Encryption 302
- Certificate is CA Certificate 78
- Certificate Request Description 80 ,  
517
- Certificate Revocation List (CRL)  
Checking 78
- Channel 303
- Channel Bundling 405
- Channel Plan 308
- Charges 576
- Check PIN 273 , 617
- Class ID 360 , 366
- Class map 360
- Client Band select 314
- Client Type 417
- Code 471
- Code for Doorcom Call Acceptance  
266
- Codec Profile 172 , 190 , 199 , 203
- Codec Profiles 113 , 117
- Codec Proposal Sequence 121
- Command Mode 517
- Command Type 517
- Common Name 82
- Compare Condition 512
- Compare Value 512
- Config Mode 429
- Configuration contains certificates/keys  
517
- Congestion Avoidance (RED) 368
- Connected clients 318
- Connection Idle Timeout 385 , 391 ,  
396 , 401 , 408
- Connection State 356 , 371 , 544
- Connection Type 401
- Connections Nr. 191
- Consider 347
- Consider public holidays 241
- Continuity Check (CC) End-to-End  
422
- Continuity Check (CC) Segment 422

- Control Mode 363 , 424
- Conversation Display 175 , 603
- COS Filter (802.1p/Layer 2) 356 , 371 , 544
- Count 517
- Country 82
- Create NAT Policy 387 , 392 , 396 , 402 , 409
- CSV File Format 517
- Current Class of Service 576
- Custom 82
- Custom DHCP Options 497
- Cyclic Background Scanning 305
- D Channel Mode 440
- Date (DD - MM) 243
- Deactivate number suppression 113
- Default Ethernet for PPPoE Interfaces 415
- Default Idle Timeout 542
- Default Route 387 , 392 , 396 , 402 , 409 , 429
- Default Signalling during Calls 175 , 603
- Default User Password 69
- Delete SIP bindings after Restart 113
- Description 74 , 78 , 86 , 90 , 109 , 119 , 121 , 126 , 131 , 134 , 141 , 157 , 169 , 186 , 189 , 198 , 201 , 223 , 224 , 228 , 231 , 234 , 236 , 237 , 240 , 243 , 243 , 247 , 250 , 252 , 261 , 267 , 302 , 305 , 328 , 331 , 338 , 351 , 356 , 360 , 366 , 371 , 374 , 385 , 391 , 396 , 401 , 408 , 413 , 427 , 433 , 442 , 449 , 454 , 468 , 469 , 469 , 471 , 471 , 473 , 483 , 499 , 512 , 517 , 544 , 547 , 593 , 598 , 615
- Destination 462 , 465
- Destination immediately 595
- Destination Port/Range 339 , 351 , 356 , 371 , 544
- Destination Address / Length 331
- Destination Interface 331 , 383
- Destination IP Address/Netmask 327 , 339 , 351 , 433
- Destination IP Address 512 , 517 , 535
- Destination IPv4 Address/Netmask 356 , 371 , 544
- Destination IPv6 Address/Length 356 , 371 , 544
- Destination on Busy 595
- Destination on no Reply 595
- Destination Port 328 , 433
- Destination Port Range 471
- Device 302
- DH Group 442
- DHCP Broadcast Flag 286
- DHCP Client 280
- DHCP Client 388 , 398
- DHCP Hostname 286 , 415
- DHCP MAC Address 286 , 415
- DHCP Mode 287
- DHCP Options 495
- DHCP Server 280
- Dial Control 143
- Dial End Monitoring Time 113
- Dialling Authorization 141
- Direct Call 576
- Direct Call Number 231
- Direction 360
- Directory Softkey 175 , 603
- Display Language 172 , 195
- Displayed Description 137 , 138 , 191 , 199
- Displayed Name 130
- Distribution Policy 347 , 348
- Distribution Mode 347
- Distribution Ratio 348
- DNS domains search list 506
- DNS Hostname 485
- DNS Negotiation 389 , 393 , 399 , 406 , 410
- DNS Propagation 287
- DNS Server 412 , 455 , 493 , 506
- Do not Disturb 225 , 576 , 598
- Do not Disturb (DND) 172 , 602
- Domain 109 , 486

- Domain at the HotSpot Server 540
- Doorcom Access 154
- Downstream Bandwidth Limitation 119
- Dropping Algorithm 368
- DSCP / TOS Value 328
- DSCP Settings for rtp Traffic 120
- DSCP/Traffic Class Filter (Layer 3) 356 , 371 , 544
- DTIM Period 308
- DTMF 121
- DUID 508
- Dynamic blacklisting 315
- E-mail 82
- E-Mail Notification 271 , 618
- E-mail Address 134
- E-Mail Address (from User Settings) 271
- E-Mail forwarding behavior 618
- EAP Preauthentication 312
- Early media support 113
- Emergency Phone 172
- Enable update 490
- Enabled number 234
- Encapsulation 413
- Encrypt configuration 517
- Encryption 403
- Encryption Method 363
- End-to-End Pending Requests 420
- End-to-End Send Interval 420
- Entries 406
- Entry active 69
- Event 569
- Event List 512 , 517
- Event List Condition 517
- Event Type 512
- External Assignment 159 , 268
- External Number 596
- External Filename 84 , 85
- External Number 155 , 261
- Facility 566
- Failed attempts per Time 315
- File Encoding 84 , 85
- File Name 517
- File Name in Flash 517
- Filter 360
- Flash Time for DTMF Dialling 226
- Force certificate to be trusted 78
- Forward 486
- Forward to 486
- Fragmentation Threshold 308
- From Domain 113
- From Interface 335
- Frozen Parameters 353
- Function Button Status 512
- Further Rerouting 162 , 262 , 577
- FXS Ringing Frequency 226
- G.711 aLaw 121
- G.711 uLaw 121
- G.722 121
- G.726 (16 kbit/s) 121
- G.726 (24 kbit/s) 121
- G.726 (32 kbit/s) 121
- G.726 (40 kbit/s) 121
- G.726 Codec settings 121
- G.729 121
- Gateway 495
- Gateway Address 331
- Gateway IP Address 327
- General Prefix 283
- General Prefix active 335
- Generate international phone number 113
- Generate national subscriber number 113
- Generate Private Key 80
- Generation Mode 284
- Global CLIP no Screening Number 110 , 127
- Group Description 69 , 347 , 348
- Group ID 532
- Headset Support 172 , 602
- High Priority Class 360
- Home Number 134
- Host 486
- Host Name 490
- IGMP Proxy 381
- IGMP State Limit 380

- Immediately 162
- Incoming Phone Number 440
- Index Variables 512, 517
- Inhibited number 234
- Interface 60, 61, 169, 223, 224, 266, 325, 333, 338, 348, 363, 376, 380, 424, 483, 486, 490, 494, 505, 517, 534, 540, 549
- Interface Action 534
- Interface Mode 279, 483
- Interface Status 512
- Interface Traffic Condition 512
- Interfaces 119, 360
- Internal Assignment 133, 159, 268
- Internal Number 137, 138, 155, 157, 164, 191, 199, 225, 232, 261, 264, 266, 271
- Internal Number and Rerouting Settings 165
- Internal Numbers 136, 170, 201, 223, 228
- Internet Key Exchange 427
- Interval 512, 517, 532, 535
- Intra-cell Repeating 311
- IP Version of the tunneled Networks 427
- IP Address 415, 416, 499, 566, 574
- IP Address Assignment 429
- IP Address / Netmask 280
- IP Address Mode 387, 392, 396, 402, 409
- IP Address Range 412, 455, 493
- IP Assignment Pool 402, 429
- IP Compression 452
- IP Pool Name 412, 455, 493, 494
- IP Version 471
- IP Version 483
- IP/MAC Binding 189, 198
- IPv4 469
- IPv4 Address 485
- IPv4 Back Route Verify 435
- IPv4 Proxy ARP 435
- IPv6 280, 388, 398, 469
- IPv6 Address 485
- IPv6 Addresses 280
- IPv6 Mode 280, 388, 398
- ISDN Synchronisation 91
- Key Extension Module 171
- Key Size 517
- Language for login window 540
- Last Device Configuration 186, 615
- Last Member Query Interval 380
- Layer 4 Protocol 328
- LCP Alive Check 389, 393, 399, 410
- LDAP URL Path 86
- Lease Time 495
- Level 566
- Level No. 74
- Licence Key 55
- Licence Serial Number 55
- Lifetime 442, 449
- Link Prefix 283
- Local Certificate 442
- Local Certificate Description 84, 85, 517
- Local File Name 517
- Local ID 427
- Local ID Type 427, 442
- Local ID Value 442
- Local IP Address 327, 387, 392, 396, 402, 409, 429
- Local IPv6 Network 431
- Local PPTP IP Address 393
- Local WLAN SSID 517
- Locality 82
- Location 113, 169, 189, 198, 201, 302
- Login Frameset 542
- Long Retry Limit 308
- Loopback End-to-End 420
- Loopback Segment 420
- MAC Address 189, 198, 279, 415, 499
- Mail Exchanger (MX) 491
- Matching String 569
- Max Recording Time 271
- Max waiting time in the queue 244



- Max. number of clients - hard limit 314
- Max. number of clients - soft limit 314
- Max. queue size 368
- Max. Transmission Rate 306
- Maximum Burst Size (MBS) 418
- Maximum Downstream Bandwidth 119
- Maximum Number of Dialup Retries 389 , 393 , 399 , 403 , 410
- Maximum Response Time 380
- Maximum Upload Speed 363 , 366 , 424
- Maximum Upstream Bandwidth 119
- Members 468 , 469 , 473
- Menus 75
- Message Compression 569
- Message Timeout 569
- Metric 327 , 331 , 333 , 429
- MIB Variables 517
- MIB/SNMP Variable to add/edit 517
- Min. queue size 368
- MobiKE 435
- Mobile Number 134 , 199
- Mode 80 , 328 , 380 , 406 , 440 , 442 , 454
- Mode for status "In the Office" 273 , 617
- Mode for status "Out of Office" 273 , 617
- Module 1: Software Version 187 , 615
- Module 1: Type / Serial Number 187 , 615
- Monitored Interface 512
- Monitored Subsystems 569
- Monitored Variable 512
- Monitored Certificate 512
- Monitored Interface 534
- Monitored IP Address 532
- MTU 391
- Multicast Group Address 383
- Multiple SIP Connections (Sub-Exchange) 203
- Music on Hold 154
- Mute after hands-free Calling 175 , 603
- Name 90 , 134 , 302 , 335 , 454 , 505 , 576 , 577
- NAT method 338
- NAT Traversal 447
- Net Direct (Keypad) 153
- Netmask 415 , 416
- Network Name (SSID) 311
- New Destination IP Address/Netmask 342
- New Destination Port 342
- New Source IP Address/Netmask 342
- New Source Port 342
- Night 135
- No Hold and Retrieve 190 , 199 , 203
- Number 576 , 577 , 597
- Number of allowed simultaneous Calls 113
- Number of Admitted Connections 434
- Number of Messages 569
- Number of playbacks 246
- Number of Spatial Streams 305
- Number of Used Ports 406
- Numbers 163 , 263
- OAM Flow Level 420
- On Busy 162
- On Link Flag 285
- Operation Band 305
- Operation Mode 303 , 305
- Optional 135
- Organization 82
- Organizational Unit 82
- Original Destination Port/Range 339
- Original Destination IP Address/Netmask 339
- Original Source Port/Range 339
- Original Source IP Address/Netmask 339
- OSPF Mode 406
- Outbound Interface 366
- Outgoing Signalisation 110 , 127 , 137
- Outgoing Phone Number 440

- Overbooking allowed 366
- Overwrite similar certificate 517
- P-P Additional MSN 130
- P-P Base Number 130
- P-P DDI Exception 130
- Parallel Ringing 155 , 576
- Parent Location 119
- Password 76 , 80 , 84 , 85 , 109 , 139 , 385 , 391 , 396 , 401 , 408 , 454 , 490 , 509 , 517 , 547
- Password for IP Phone Registration 139
- Password for protected Certificate 517
- PBX coupling 113
- Peak Cell Rate (PCR) 418
- Peer Address 427
- Peer ID 427
- Permanent Layer 2 Activation 91
- Permit Call Forwarding 157
- Personal Access 139
- Phase-1 Profile 434
- Phase-2 Profile 434
- Phone Number 252 , 593
- Phone Type 169 , 186 , 189 , 198 , 615
- Pick-up Group 147
- PIN 497
- PIN (6 Digit Numeric) 165
- PIN for Phone Access 139
- Policy 71
- Pool Usage 494
- Pop-Up window for status indication 542
- Port 126 , 492
- Port Number 202
- Port STUN server 112
- Ports 126
- Post Login URL 540
- PPPoE Ethernet Interface 385
- PPPoE Interfaces for Multilink 385
- PPPoE Mode 385
- PPTP Address Mode 393
- PPTP Ethernet Interface 391
- Preferred Lifetime 285
- Preshared Key 312 , 427
- Primary DNS Server DNS-Server (IPv4/IPv6) 486
- Primary IPv4 DNS Server 483
- Primary IPv6 DNS Server 483
- Prioritisation Algorithm 363
- Prioritize TCP ACK Packets 389 , 393 , 399 , 410 , 416
- Priority 69 , 366 , 483
- Priority Number 234
- Priority Queueing 366
- Propagate PMTU 452
- Proposals 442 , 449
- Protocol 333 , 339 , 351 , 356 , 371 , 433 , 471 , 492 , 517 , 544 , 566
- Protocol Header Size below Layer 3 363
- Provider 413 , 490
- Provider Name 492
- Provider Status 109
- Provider without Registration 113
- Provisioning Server 497
- Proxy 112
- Proxy ARP 286
- Proxy ARP Mode 406
- Proxy Interface 381
- Proxy Port 112
- Public Interface 435
- Public Interface Mode 435
- Public Source IPv4 Address 435
- Query Interval 380
- Queues/Policies 363
- RA Encrypt Certificate 80
- RA Sign Certificate 80
- RADIUS Dialout 71
- RADIUS Secret 69
- Radius Server 312
- RADIUS Server Group ID 454
- Real Time Jitter Control 363
- Reboot after execution 517
- Reboot device after 517
- Receive Announcement Calls 153 , 576 , 603

- Receive Intercom Calls 576
- Receive MWI Information 153
- Receive System Intercom Call 153 ,  
603
- Receiving UUS 175 , 603
- Recipient 569
- Registrar 111
- Registrar Port 111
- Registration Timer 112
- Relay Contact(s) Access 154
- Release Date and Time 186 , 615
- Remaining Validity 512
- Remote File Name 517
- Remote IPv6 Network 431
- Remote PPTP IP Address 393
- Remote User (for Dialin only) 401
- Reporting Method 376
- Rerouting Application 138 , 164
- Rerouting Function 262
- Rerouting on no response 162 , 262 ,  
577
- Rerouting to Number 166
- Response 485
- Retries 71
- Robustness 380
- Role 454
- Room Monitoring 576
- Route 236 , 333
- Route Active 331
- Route and Charge Assignment 159
- Route Class 325
- Route Entries 387 , 392 , 396 , 402 ,  
409 , 429
- Route Selector 349
- Route Type 325 , 331
- Router Preference 287
- Router Lifetime 287
- Routing Mode 236
- Routing Stage 1 238
- Routing Stage 2 238
- RTS Threshold 308
- RTT Mode (Realtime Traffic Mode)  
366
- Rule Chain 374 , 376 , 549
- Rx Shaping 317
- Save call data records 154
- Save configuration 74
- SCEP URL 80
- Secondary DNS Server (IPv4/IPv6)  
486
- Secondary IPv4 DNS Server 483
- Secondary IPv6 DNS Server 483
- Security Mode 312
- Security Policy 280 , 280 , 387 , 388 ,  
392 , 396 , 398 , 429 , 431
- Segment Pending Requests 420
- Segment Send Interval 420
- Select file 250
- Select Interface 133
- Select lines 264
- Select radio 517
- Select vendor 497 , 497
- Selection 471
- Send WOL packet over Interface 547
- Sequence of Trunk Lines in Group  
131
- Serial Number 169 , 186 , 615
- Server 492
- Server Address 517
- Server IP Address 69
- Server Timeout 71
- Server URL 517
- Service 339 , 351 , 356 , 371 , 462 ,  
465 , 544
- Set COS value (802.1p/Layer 2) 360
- Set DSCP/Traffic Class Filter (Layer 3)  
360
- Set interface status 517
- Set status 517
- Setup Mode 283
- Severity 569
- Short Guard Interval 308
- Short Retry Limit 308
- Show Connected Number (COLP)  
143
- Show Date and Time 226
- Show incoming Name (CNIP) 226
- Show incoming Number (CLIP) 226

- Show incoming waiting Number (CLIP off Hook) 226
- Show new Messages (MWI) 226
- Show Outgoing Number (CLIP) 143
- Signal fixed out number 110 , 127
- Signal remote caller number 110 , 127
- Signalling 160 , 268 , 577
- Silent Deny 376
- Simultaneous after time 158 , 268
- Single Number (MSN) 130
- SIP Client IP Address 202
- SIP Client Mode 202
- SIP Header Field for User Name 113
- SIP Header Field(s) for Caller Address 113
- Size of Queue 244
- SNTP Server 506
- Software Version 186 , 615
- Source 462 , 465
- Source Address / Length 331
- Source Interface 328 , 351 , 383
- Source IP Address/Netmask 328 , 339 , 351 , 433
- Source IP Address 512 , 517 , 532 , 535
- Source IPv4 Address/Netmask 356 , 371 , 544
- Source IPv6 Address/Length 356 , 371 , 544
- Source Location 517
- Source Port 328 , 433
- Source Port Range 471
- Source Port/Range 339 , 351 , 356 , 371 , 544
- Special Handling Timer 351
- Speed Dial Number 252
- SRTP 117
- Standard 135
- Start Mode 434
- Start Time 516
- State/Province 82
- Static Addresses 284
- Static Interface Identifier 508
- Status 163 , 263 , 512 , 576 , 598
- Status LED 175 , 603
- Status of Mail Box Owner 273 , 617
- Stop Time 516
- STUN server 112
- Subject 569
- Subject Name 517
- Subnet ID 283
- Substitution of International Prefix with "+" 113
- Substitution of Incoming Number Prefix 113
- Successful Trials 532
- Summary 82
- Sustained Cell Rate (SCR) 418
- Switch call signalling 157 , 247 , 262 , 577
- Switch signalling 267
- Switch signalling variants manually 147
- Switch to SNMP Browser 74
- Switching Points 240 , 241
- System Phonebook Authorization 154
- T.38 FAX support 113
- Take Waiting Calls with 244
- TAPI 154
- Target MAC-Address 547
- Target Number 245
- Target Number "Immediate" 232
- Target Number "On busy" 232
- Target Number "On no reply" 232
- TCP-MSS Clamping 286
- Team Speed Timer 158 , 262 , 268
- Terminal 576
- Terminal Endpoint Identifier (TEI) 133
- Terminal Type 223 , 225
- Terms &Conditions 540
- Throughput 318
- Throughput/client 319
- Ticket Type 542
- Time Condition 516
- Time for Rerouting on No Reply 245
- Timestamp 566
- Tracking IP Address 349

- Traffic Shaping 366
- Traffic Direction 512
- Traffic shaping 363
- Transfer Mode 440
- Transfer own IP address over ISDN/  
GSM 440
- Transfer with 245
- Transferred Traffic 512
- Transmit charge information 154
- Transmit Charges Pulses 226
- Transmit Key 312
- Transmit Power 303
- Transmit Router Advertisement 280
- Transparent MAC Address 61
- Transport Protocol 111 , 112 , 202
- Trials 512 , 535
- Trigger 534
- Trigger Status 517
- Trunk 130 , 163 , 166
- Trunk Line Selection with Line Access  
Number 141
- Tx Shaping 317
- Type 119 , 335 , 356 , 371 , 413 , 471  
, 544 , 547 , 595
- Type of Number 128 , 130
- Type of Call Forwarding 232
- Type of Messages 566
- Type of Rerouting Application 247
- Type of Rerouting Function 243
- Type of traffic 338
- UDP Port 71
- UMTS/LTE Interface 408
- Unsuccessful Trials 532
- Update Interval 492
- Update Path 492
- Upstream Bandwidth Limitation 119
- Upstreaming Device with NAT 113
- URL SCEP Server URL 517
- Usage Type 403
- Use CRL 517
- Use global rerouting 147
- Use PFS Group 449
- Use settings from 240 , 241
- Used Channel 303
- Used Prefix / Length 335
- User 76 , 191 , 199 , 264
- User Defined Channel Plan 308
- User must change password 76
- User Name 109 , 139 , 385 , 391 ,  
396 , 401 , 408 , 490 , 509
- Users 454
- Users assigned/Users logged on 577
- Valid Lifetime 285
- Vendor Description 497 , 497
- Vendor Mode 69
- Vendor Option String 497
- Version Check 517
- Video 117
- Virtual Channel Connection (VCC)  
418 , 420
- Virtual Channel Identifier (VCI) 413
- Virtual Path Connection (VPC) 420
- Virtual Path Identifier (VPI) 413
- VLAN 316 , 385
- VLAN ID 279 , 316 , 385
- VLAN Identifier 290
- VLAN Members 290
- VLAN Name 290
- Voice Mail Language 271
- Volume 250
- Wake-On-LAN Filter 547
- Wake-On-LAN Rule Chain 547
- Walled Garden 540
- Walled Garden URL 540
- Weight 366
- Wildcard 491
- Wildcard MAC Address 61
- Wildcard Mode 61
- Wireless Mode 306
- WLC SSID 517
- WMM 311
- WPA Cipher 312
- WPA Mode 312
- WPA2 Cipher 312
- Wrap-up Time 265
- Wrap-up Timer 158
- Write certificate in configuration 517
- XAUTH Profile 434

- Zones 237
- 2,4/5 GHz changeover 586
- ACCESS\_ACCEPT 68
- ACCESS\_REJECT 68
- ACCESS\_REQUEST 68
- ACCOUNTING\_START 68
- ACCOUNTING\_STOP 68
- Action 252 , 323 , 555 , 579 , 581
- Active Calls 260
- Active Clients 586
- Active Variant 270
- ADSL Logic 555
- Agents assigned 260
- Agents in Wrap-up 260
- Agents logged on 260
- Alarm Input 44
- Alert Service 571
- Alive Check 579
- Allow manual trunk group selection 600
- Answer to client request 537
- Answered of Calls Today 260
- AP discovered 318
- AP managed 318
- AP offline 318
- Applications 153
- ARS 235
- As DHCP Server 482
- As IPCP Server 482
- Assign project codes 56
- Attacked Access Point 321
- Authentication for PPP Dialin 73
- Authentication Method 579
- Authorizations 139
- Back Route Verify 334
- Basic Settings 141
- BOSS 555
- Bridge Link Description 587 , 587
- Busy on busy 599
- Bytes 579
- Cache Hitrate (%) 488
- Cache Hits 488
- Cache Size 481
- Call Forwarding 595
- Call Forwarding (CFNR) 51
- Call from 619
- Call Status 619
- Call Through 592
- Called Number 255 , 593
- Called Number 259
- Caller Number 258
- CAPI Server TCP Port 510
- Certificate Request 80
- Charge Information (S0 / Upn Extension) 43
- Charge Rate Factor 43
- Check PIN 616
- Class 551
- Client MAC Address 585
- Client Registration Timer 123
- Compression 65
- Configuration Interface 59
- Configuration Encryption 555
- Confirm Admin Password 46
- Connected clients/VSS 318
- Contact 39
- Corrupt Frames Received 583
- Costs 255 , 593
- Country Profile 42
- CPU usage [%] 318
- CTS frames received in response to an RTS 583
- Currency 43
- Current Class of Service 600
- Current File Name in Flash 555
- Current Local Time 48
- Data Rate mbps 584 , 585
- Date 255 , 255 , 258 , 259 , 578 , 593 , 594
- Date/Time 619
- Default Behavior 118
- default MSN 92
- Delete 258 , 259 , 321 , 332
- Delete call data records 257
- Delete complete IPsec configuration 455
- Delete Phonebook 254
- Denied Clients soft/hard 586

- Description 126 , 228 , 275 , 559 ,  
560 , 579 , 579 , 581 , 582 , 583 ,  
592 , 599
- Destination File Name 555
- Destination IP Address 332
- Details 579
- Device Info 186 , 615
- DHCP Server 298
- Dialling Authorization 600
- Direct Call 51 , 597
- DNS domains search list 506
- DNS Requests 488
- DNS Server 507
- Do not Disturb 597
- Domain Name 481
- Done 323
- Doorcom Signalling 44
- Drop non-members 290
- Drop untagged frames 290
- Dropped 581 , 589
- DSA Key Status 64
- DSCP Settings for sip Traffic 124
- Duplicate received MSDUs 583
- Duration 255 , 255 , 593 , 594
- Dynamic RADIUS Authentication 456
- Enable IPsec 455
- Enable server 510
- Enable VLAN 291
- Encrypted 581
- Encryption Algorithms 64
- Error 323
- Errors 579 , 581
- Expires 551
- Explicit Call Transfer 52
- Export call data records 257
- Extended Route 332
- Extension Numbers 600
- Extension Rerouting 44
- External Door Connections 51
- External Number 255 , 594
- External Port 126
- Factory Reset Firewall 468
- Fallback interface to get DNS server  
481
- Faxheader 510
- Features 145
- Filename 555
- Firmware Update 563
- First seen 321 , 587 , 587
- First Timeserver 49
- Forwarded Requests 488
- Frame transmissions without ACK re-  
ceived 583
- Function 92
- Gateway 332
- General 156 , 168 , 188 , 197 , 239 ,  
247 , 261 , 267
- Global Rerouting 44 , 44
- Hashing Algorithms 64
- Home Office Number 599
- Host for multiple locations 543
- HTTPS TCP Port 489
- IGMP State Limit 382
- IGMP Status 382
- Ignore Certificate Request Payloads  
458
- IKE (Phase-1) 581
- IKE (Phase-1) SAs 579
- Image already exists. 323
- Include certificates and keys 555
- Int. No. 255 , 255 , 258 , 259 , 593 ,  
594
- Interconnect external calls 41
- Interface 255 , 255 , 258 , 259 , 290 ,  
298 , 332 , 334 , 537 , 588 , 589 ,  
593 , 594
- Interface Selection 550
- Interface / Location 228
- Interface Description 59
- Interface is UPnP controlled 537
- Internal Number 270 , 275 , 563 , 616  
, 619
- Internal Numbers 228
- Internal Time Server 49
- International Prefix / Country Code 42
- Invalid DNS Packets 488
- IP Address 584 , 585 , 588
- IP Address / Netmask 582

- IP Address Range 298
- IPSec (Phase-2) 581
- IPSec (Phase-2) SAs 579
- IPSec Debug Level 455
- IPSec over TCP 456
- IPSec Tunnels 580
- IPv4 Firewall Status 466
- IPv4 Full Filtering 466
- ISDN Timeserver 49
- Keys 178 , 191
- Language 270 , 275
- Last seen 321 , 587 , 587
- Level 578
- License Allocation 270
- Lifetime 276
- Line 260
- Line Access Digit 56
- Load firmware 562
- Local Address 582
- Local Certificate 125 , 489
- Local ID 579
- Local IP Address 579
- Local Port 579 , 582
- Location 39
- Log Format 568
- Log on / Log off 163 , 263 , 598
- Log out immediately 551
- Logged Actions 466
- Logging Level 65
- Login Grace Time 65
- Login Name 599
- Logon 588
- Logout Options 551
- Loopback active 337
- Lost Calls Today 260
- MAC Address 560 , 582 , 584 , 586 , 588
- Management VID 291
- Max Call List entries for System Calls 259
- Max Call List entries per User 259
- Maximum Message Level of Syslog Entries 39
- Maximum E-mails per Minute 571
- Maximum Groups 382
- Maximum Number of Accounting Log Entries 39
- Maximum number of concurrent connections 63
- Maximum Number of Syslog Entries 39
- Maximum Sources 382
- Maximum TTL for Negative Cache Entries 481
- Maximum TTL for Positive Cache Entries 481
- mbps 583
- Memory usage [%] 318
- Message 578
- Messages 579
- Metric 332
- Mobile Number 599
- Mode 334 , 382
- Mode / Bridge Group 59
- Mode for status "In the Office" 616
- Mode for status "Out of Office" 616
- MSDUs that could not be transmitted 583
- MTU 579
- Multicast MSDUs transmitted successfully 583
- Multicast MSDUs received successfully 583
- Multicast Routing 379
- Name 92 , 253 , 599
- NAT 582
- NAT active 337
- NAT Detection 579
- National Prefix / City Code 42
- Negative Cache 481
- Negotiation Type 579
- Netmask 332
- Network Name (SSID) 321
- Network Name (SSID) 586
- New Calls 274 , 616
- New File Name 555
- No. 334 , 562 , 578 , 581
- Noise dBm 584 , 585 , 587 , 587



- Notification 270
- Nr. 126
- Number 274
- Numbers 136 , 191 , 199
- Old Calls 274 , 616
- Optional Rerouting 138
- Other Inactivity 467
- Outgoing Signalisation 137
- Overview 318
- Packets 579
- Parallel Ringing 596
- Passed 581
- Password 571
- Password for HTML Configuration Access 599
- Password for IP Phone Registration 599
- Phone Number 253 , 592
- Phone Type 228 , 559 , 560 , 562
- Phone Version 560
- Physical Address 588
- Pick-up (Extension) 56
- Pick-up Group 56 , 600
- PIN for Phone Access 599
- PIN1 46
- PIN2 46
- POP3 Timeout 571
- POP3 Server 571
- Port 337 , 588
- Port STUN server 466
- Positive Cache 481
- PPTP Inactivity 467
- PPTP Passthrough 337
- Primary DHCP Server 499
- Privacy Number Truncation 256
- Project Code 255 , 255 , 593 , 594
- Protocol 332
- PVID 290
- QoS Queue 589
- Queued 589
- Rate 585 , 587
- Received DNS Packets 488
- Received MPDUs that couldn't be decrypted 583
- Record calls 259
- Record connected calls 259
- Region 298
- Remote Access (e.g. Follow me, Room Monitoring) 46
- Remote Address 582
- Remote ID 579
- Remote IP 579
- Remote IP Address 551
- Remote IP Address 579
- Remote MAC 587 , 587
- Remote Networks 579
- Remote Port 579 , 582
- Rerouting of Incoming Distribution 44
- Rerouting to Number 41
- Restore Default Settings 62
- Return Address 276
- Rogue Client MAC Address 321
- Route Type 332
- Routing Stage 235
- RSA Key Status 64
- RTP Port 123
- RTS frames with no CTS received 583
- Running 323
- Rx Bytes 581 , 582
- Rx Errors 581
- Rx Packets 581 , 582 , 583 , 584 , 585 , 587 , 587
- Save incoming calls 256
- Save outgoing calls 256
- Saved Calls 616
- Schedule Interval 528
- SD Card Vers. 559 , 560
- Second Timeserver 49
- Secondary DHCP Server 499
- Security Algorithm 579
- Select file 252 , 555
- Send 589
- Send Certificate Chains 458
- Send Certificate Request Payloads 458
- Send CRLs 458
- Send Initial Contact Message 456

- Send Key Hash Payloads 458
- Sender E-mail Address 571
- Separator 252
- Serial Number 559
- Server preference 507
- Server Failures 488
- Set Date 49
- Set Time 49
- Settings 172 , 195 , 200 , 602
- Show passwords and keys in clear text 47
- Signal 319
- Signal dBm 321
- Silent Deny 337
- Slave AP LED mode 298
- Slave AP location 298
- SMS Device 572
- SMTP Authentication 571
- SMTP Password 276
- SMTP Port 571
- SMTP Server 276 , 571
- SMTP Server Port 276
- SMTP User Name 276
- SNMP Listen UDP Port 67
- SNMP multicast discovery 67
- SNMP Read Community 47
- SNMP Trap Broadcasting 573
- SNMP Trap Community 573
- SNMP Trap UDP Port 573
- SNMP Version 67
- SNMP Write Community 47
- SNR dB 585
- SNTP Server 507
- Source File Name 555
- Source Location 323 , 555
- Speed Dial 56
- Speed Dial Number 592
- SSH Port 63
- SSH service active 63
- SSID 321
- Static Blacklist 321
- Status 92 , 562 , 579 , 580 , 581 , 582
- Status of Mail Box Owner 616
- Status/Update Status 559 , 560
- STUN Handler 466
- Subsystem 578
- Successfully Answered Queries 488
- Sync SAs with ISP interface state 456
- Systel Version 559
- System Admin Password 46
- System Logic 555
- System Name 39
- System Parking (Open Enquiry) 52 , 56
- T400 178
- T400/2 178
- T500 178
- TCP Inactivity 467
- TCP Keepalives 65
- Team Signalling 44
- Test Ping Address 552
- Test Ping Mode 552
- Third Timeserver 49
- Throughput 319
- Time 255 , 255 , 258 , 259 , 578 , 593 , 594
- Time Update Interval 49
- Time Update Policy 49
- Time Zone 48
- Total 581
- Trace Mode 550
- Traceroute Address 553
- Traceroute Mode 553
- Transfer call data records via Serial 2 256
- Transfer Signalling 41
- Transfer to busy extension 41 , 52
- Transmitted MPDUs 583
- Trunk Group Selection 56
- Trunk Number 258 , 259
- Tx Bytes 581 , 582
- Tx Errors 581
- Tx Packets 581 , 582 , 583 , 584 , 585 , 587 , 587
- Type 258 , 259 , 581
- Type of attack 321
- UDP Inactivity 467
- Unchanged for 581

- Unicast MPDUs received successfully 583
- Unicast MSDUs transmitted successfully 583
- Update by time 559
- Update enabled 560
- Update immediately 559 , 560
- UPnP Status 537
- UPnP TCP Port 537
- Uptime 584 , 585 , 587
- URL 323 , 555
- Use Interface 552
- Use Zero Cookies 456
- User 255 , 255 , 258 , 259 , 270 , 274 , 551 , 593 , 594 , 616 , 619
- User Name 571 , 588
- User password 601
- Value 583
- Variant 158 , 248
- Version 562
- View 260
- Voice Mail System 275
- VSS Description 586
- Waiting Calls 260
- Web Access Password 254 , 256 , 265
- Web Access Username 254 , 256 , 265
- WINS Server 481
- WLAN Controller: VSS throughput 318
- Zero Cookie Size 456
- Access Filter 370
- Access Profiles 74
- Access Type 38
- Action 553
- Actions 517
- Active Clients 319
- Active IPsec Tunnels 38
- Active Sessions (SIF, RTP, etc... ) 38
- Address List 469
- Administration 291
- Agents 264
- Alert Recipient 569
- Alert Settings 571
- Allow manual trunk group selection 591
- analog 224
- Assigned elmeg Phones 600
- Assigned System Phones 601
- BOSS Version 38
- Bridge Links 586
- Cache 487
- Call Forwarding 231
- CAPI 228
- Certificate List 78
- Certificate Servers 86
- Class of Services 141
- Client Management 320 , 586
- Codec Profiles 121
- Controlled Interfaces 423
- CPU Usage 38
- CRLs 85
- Current Class of Service 591
- Date 48
- Description 38 , 590
- DHCP Configuration 494
- DHCP Relay Settings 499
- DHCPv6 Global Options 506
- DHCPv6 Server 505
- Dial Control 233
- Dialling Authorization 591
- Direct Call 230
- Directory Name 553
- Directory Tree 553
- DNS Servers 483
- DNS Test 552
- Domain Forwarding 486
- Doorcom Signalling 267
- DSP Module 38
- Dynamic Hosts 487
- DynDNS Provider 491
- DynDNS Update 490
- elmeg DECT 196
- elmeg IP 187
- elmeg OEM 560
- elmeg System Phones 558
- Entries 251

- Feature Settings 595
- Firmware Files 562
- Firmware Maintenance 322
- General 235 , 254 , 256 , 259 , 265 ,  
275 , 298 , 537
- General Prefix Configuration 335
- General Settings 599
- Global Settings 480
- Groups 468 , 470 , 473
- Hosts 532
- HotSpot Gateway 540
- HTTP 62
- HTTPS 62
- HTTPS Server 489
- Import / Export 252
- Incoming 255 , 258 , 594
- Incoming Distribution 163
- Interface Assignment 375 , 549
- Interfaces 59 , 277 , 534 , 536 , 567
- Interfaces / Provider 236
- IP Pool Configuration 493
- IP Pools 411 , 455
- IP/MAC Binding 498
- IPSec Peers 426
- IPSec Statistics 580
- IPSec Tunnels 579
- IPv4 Filter Rules 462
- IPv4 Route Configuration 325
- IPv4 Routing Table 332
- IPv4/IPv6 Filter 356
- IPv6 Route Configuration 330
- IPv6 Routing Table 333
- ISDN 223 , 400
- ISDN External 90
- ISDN Internal 92
- ISDN Login 62
- Last configuration stored 38
- Lines 261
- Load Balancing Groups 346
- Log out Users 551
- Memory Card 38
- Memory Usage 38
- Misdial Routing 166
- Name, First Name 590
- NAT Configuration 338
- NAT Interfaces 337
- Neighbor APs 320
- Network Status 583
- Night Mode Status 38
- No. 38
- OAM Controlling 419
- Options 73 , 334 , 382 , 455 , 466 ,  
510 , 528 , 543 , 554 , 568
- Outgoing 255 , 258 , 593
- Overview 228
- Parallel Ringing 155
- Passwords 45
- Phase-1 Profiles 442
- Phase-2 Profiles 449
- Pick-up Group 591
- Ping 62
- Ping Generator 535
- Ping Test 552
- Port Configuration 290
- PPPoA 395
- PPPoE 385
- PPTP 391
- Priority Numbers 234
- Profiles 413
- QoS Classification 360
- QoS Interfaces/Policies 362
- Radio Profiles 304
- RADIUS 68
- Registrar 38
- Rerouting Applications 247
- Rerouting Functions 243
- Rogue APs 321
- Rogue Clients 321
- Routing 237
- Rule Chains 374
- Serial Number 38
- Service Categories 417
- Service List 471
- Settings 563 , 616
- SIP Provider 109
- Slave Access Points 301 , 318
- SNMP 62 , 66
- SNMP Trap Hosts 574

- SNMP Trap Options 573
- Special Session Handling 350
- SSH 62, 63
- Stateful Clients 508
- Static Hosts 485
- Statistics 488, 581
- Status 38, 260, 274
- Syslog Servers 565
- System 39
- System Date 38
- System Licences 54
- System Messages 578
- System Phone 167
- System Phonebook 592
- System Reboot 563
- Teams 577
- Telnet 62
- Time 48
- Timer 51
- Traceroute Test 552
- Trigger 511
- Trunk Groups 131
- Trunk Numbers 129
- Trunks 126
- UMTS/LTE 408
- Uptime 38
- User 509
- User Phonebook 593
- Users 76, 133, 576
- VLANs 289
- Voice Mail Boxes 270
- VoIP 201
- VSS 584
- Wake-On-LAN Filter 544
- Wave Files 249
- Wireless Networks (VSS) 310, 320
- WLAN Controller 317
- WOL Rules 547
- X.31 132
- XAUTH Profiles 453
- Zones 237
- Access Codes 56
- Access Rules 369
- Additional IPv4 Traffic Filter 425
- Addresses 469
- Administrative Access 62
- Alert Service 569
- Assigned elmeg Phones 600
- ATM 412
- Automatic Route Selection 235
- Bridges 588
- Calendar 239
- Call Data Records 254, 593
- Call Distribution 163
- Call List 258
- CAPI Server 509
- Certificates 77
- Controller Configuration 298
- DHCP Server 493
- DHCPv6 Server 503
- Diagnostics 552
- DNS 479
- Doorcom Units 265
- DynDNS Client 489
- elmeg System Phones 167, 601
- Factory Reset 564
- Forwarding 383
- General 378
- Global Settings 39
- Groups 156
- HotSpot Gateway 538, 588
- HTTPS 488
- IGMP 379
- Interface Mode / Bridge Groups 57
- Interfaces 468, 581
- Internal Log 578
- Internet + Dialup 384
- IP Accounting 567
- IP Configuration 277
- IPSec 425, 578
- IPv6 General Prefixes 335
- ISDN Ports 89
- Load Balancing 346
- Log out Users 551
- Maintenance 322
- Mini Call Center 260
- Monitoring 317
- NAT 336

- Neighbor Monitoring 320
- Other phones 200
- Outgoing Services 230
- Phonebook 592
- Policies 461
- QoS 356 , 589
- Real Time Jitter Control 423
- Reboot 563
- Remote Authentication 67
- Rerouting 243
- Routes 325
- Scheduling 511
- Services 471
- Settings 109 , 595
- SIA 574
- Slave AP configuration 301
- SNMP 573
- Software & Configuration 553
- Status Information 576
- Surveillance 531
- Syslog 565
- System Phonebook 250
- Teams 156
- Trace Interface 549
- Trunk Settings 126
- Update System Phones 558
- UPnP 536
- User Settings 133
- VLAN 289
- Voice Applications 248
- Voice Mail System 269 , 616
- Wake-On-LAN 543
- Applications 239
- Call Routing 230
- External Reporting 565
- Firewall 460
- LAN 277
- Maintenance 551
- Monitoring 576
- User Access 590
- VoIP 109
- Wireless LAN Controller 292
- DHCP-Client (Configuration example) 500
- DHCP-Relay-Server (Configuration example) 500
- DHCP-Server (Configuration example) 500
- NAT (Configuration example) 344
- SIF (Configuration example) 474
- #
- #1#2, #3 83
- <
- <Internal Number> 591
- A**
- Access Type 108
- Access via LAN 28
- Action 94
- Actual Network 101 , 107
- ADSL Line Profile 99
- Analogue Ports 93
- APN (Access Point Name) 101
- Assistants 36
- Authentication Method 106
- B**
- Basic configuration 19
- Basic settings in ex works state 8
- Busy Tone Detection 95
- C**
- Cell ID 107
- Client Subscription Timer 124
- CLIP 94
- Configuration 28
- Configuration Access 73
- Configuration example - DHCP-Client 500
- Configuration example - DHCP-Relay-Server 500
- Configuration example - DHCP-Server 500

Configuration example - Load  
balancing 353  
Configuration example - NAT 344  
Configuration example - Scheduling  
528  
Configuration example - SIF 474  
Configuration example - Time-controlled  
Tasks 528  
Configuration example - VoIP 204  
Configured Speed / Mode 88  
Current Speed / Mode 88

**D**

Description 94  
Description - Connection Information -  
Link 39  
Device 107  
Dial Tone Detection 95  
Dial Tone Pause 95  
Dialling Method 94  
Dialling Method 94  
Doorcom Signalling Variant 1 and 2  
268  
Downstream 98  
Drilling template 14  
DSL Chipset 97  
DSL Configuration 97  
DSL Mode 98  
DSL Modem 97

**E**

End-of-Selection Signal 95  
Ethernet Ports 87  
Ethernet Interface Selection 88  
Ext. Module No 1 - 3 190

**F**

Fallback Number 101  
Fixed IP Address 106  
Flow Control 88  
Function 96  
Function button 512  
FXO 94

FXS 96

**G**

Gathering configuration data 20

**H**

Home PLMN 107  
HTTP/HTTPS 28

**I**

ICC ID 107  
IGMP Snooping 311  
IMEI 107  
Incoming Service Type 101  
Interface - Connection Information -  
Link 39  
Internal ISDN connection 13  
IP address 20

**K**

Keys / T400 / T400/2 / T500 606

**L**

Last Command 107  
Last Reply 107  
Load balancing (Configuration  
example) 353  
Local Services 479  
Location Area Code 107

**M**

Max. Transmission Rate 308  
Maximum Upstream Bandwidth 98  
Mobile Network Provider 105  
Modem Model 107  
Modem Status 101  
Multicast 377

**N**

Name 94 , 94 , 96 , 108

- Netmask 20
  - Network Provider 101
  - Network Quality 101 , 107
  - Network setting 23
  - Networking 325
  - Numbering 126
- O**
- Open configuration interface 29
  - Oper Status 107
  - Operating elements 29
  - Operation Mode (Active) 517
  - Operation Mode (Inactive) 517
  - Operation via the telephone 27
- P**
- Password 106
  - Physical Connection 97
  - Physical Interfaces 87
  - Pin Assignments 15
  - PLMN 108
  - Port Configuration 88
  - Preferred Network Type 101
  - Preparations 19
  - Public Source IPv6 Address 435
  - PUK 101
- R**
- Radio1 319
  - Receive charges 94
  - Reset 8
  - Reset button 14
  - Roaming Mode 105
  - Rx Data Rate mbps 587 , 587
- S**
- Scheduling (Configuration example) 528
  - Select all / Deselect all 619
  - Selected PLMN 107
  - Service Center Address 107
  - Setting up a PC 21
- Show Manufacturer Names 39
  - Signal dBm (RSSI1, RSSI2, RSSI3) 584 , 585 , 587 , 587
  - SIM Card Uses PIN 101
  - SIP Port 124
  - Smartphone 204
  - Software updates 25
  - State 108
  - Status 37 , 94 , 96
  - Subscriber Number 107
  - Support 12
  - Switch Port 88
  - System Management 37
  - System requirements 19
  - Systemsoftware 19
- T**
- T.38 FAX support 203
  - T100 191
  - Terminals 167
  - Termination 13
  - Time-controlled Tasks (Configuration example) 528
  - Transmit Shaping 98
  - Tx Data Rate mbps 587 , 587
- U**
- UMTS/LTE 100
  - UMTS/LTE Status 101
  - Upstream 98
  - User access 24
  - Username 106
- V**
- Variant 1 - 4 262
  - VoIP (Configuration example) 204
  - VPN 425
- W**
- Wall mounting 14
  - Walled Network / Netmask 540
  - WAN 384



WEP Key 1-4	312
Wizard for network setting	23
WLAN	583
WLANx	583