



Cisco Model DPC3848, DPC3848V,
and DPC3848VM DOCSIS 3.0 24x8
Wireless Residential Gateway
User Guide

Please Read

Important

Read this entire guide. If this guide provides installation or operation instructions, give particular attention to all safety statements included in this guide.

Notices

Trademark Acknowledgments

Cisco and the Cisco logo are trademarks or registered trademarks of Cisco and/or its affiliates in the U.S. and other countries. To view a list of Cisco trademarks, go to this URL: www.cisco.com/go/trademarks. DOCSIS is a registered trademark of Cable Television Laboratories, Inc. The Wi-Fi Protected Setup mark is a mark of the Wi-Fi Alliance.

Other third party trademarks mentioned are the property of their respective owners.

The use of the word partner does not imply a partnership relationship between Cisco and any other company. (1110R)

Publication Disclaimer

Cisco Systems, Inc. assumes no responsibility for errors or omissions that may appear in this publication. We reserve the right to change this publication at any time without notice. This document is not to be construed as conferring by implication, estoppel, or otherwise any license or right under any copyright or patent, whether or not the use of any information in this document employs an invention claimed in any existing or later issued patent.

Disclaimer

The maximum performance for wireless is derived from IEEE Standard 802.11 specifications. Actual performance can vary, including lower wireless network capacity, data throughput rate, range and coverage. Performance depends on many factors, conditions and variables, including distance from the access point, volume of network traffic, building materials and construction, operating system used, mix of wireless products used, interference and other adverse conditions.

Software and Firmware Use

The software described in this document is protected by copyright law and furnished to you under a license agreement. You may only use or copy this software in accordance with the terms of your license agreement.

The firmware in this equipment is protected by copyright law. You may only use the firmware in the equipment in which it is provided. Any reproduction or distribution of this firmware, or any portion of it, without our express written consent is prohibited.









Copyright

© 2014 Cisco Systems, Inc. All rights reserved.

Information in this publication is subject to change without notice. No part of this publication may be reproduced or transmitted in any form, by photocopy, microfilm, xerography, or any other means, or incorporated into any information retrieval system, electronic or mechanical, for any purpose, without the express permission of Cisco Systems, Inc.

Notice to Installers

The servicing instructions in this notice are for use by qualified service personnel only. To reduce the risk of electric shock, do not perform any servicing other than that contained in the operating instructions, unless you are qualified to do so.

<p>Note to System Installer</p> <p>For this apparatus, the coaxial cable shield/ screen shall be grounded as close as practical to the point of entry of the cable into the building. For products sold in the US and Canada, this reminder is provided to call the system installer's attention to Article 820-93 and Article 820-100 of the NEC (or Canadian Electrical Code Part 1), which provides guidelines for proper grounding of the coaxial cable shield.</p>	<table border="1"><tr><td></td><td>CAUTION RISK OF ELECTRIC SHOCK DO NOT OPEN</td><td></td></tr><tr><td></td><td>AVIS RISQUE DE CHOC ÉLECTRIQUE NE PAS OUVRIR</td><td></td></tr></table>		CAUTION RISK OF ELECTRIC SHOCK DO NOT OPEN			AVIS RISQUE DE CHOC ÉLECTRIQUE NE PAS OUVRIR	
	CAUTION RISK OF ELECTRIC SHOCK DO NOT OPEN						
	AVIS RISQUE DE CHOC ÉLECTRIQUE NE PAS OUVRIR						
<p></p> <p>This symbol is intended to alert you that uninsulated voltage within this product may have sufficient magnitude to cause electric shock. Therefore, it is dangerous to make any kind of contact with any inside part of this product.</p>	<p>CAUTION: To reduce the risk of electric shock, do not remove cover (or back). No user-serviceable parts inside. Refer servicing to qualified service personnel.</p> <p>WARNING TO PREVENT FIRE OR ELECTRIC SHOCK, DO NOT EXPOSE THIS UNIT TO RAIN OR MOISTURE.</p> <p></p> <p>This symbol is intended to alert you of the presence of important operating and maintenance (servicing) instructions in the literature accompanying this product.</p>						



Notice à l'attention des installateurs de réseaux câblés

Les instructions relatives aux interventions d'entretien, fournies dans la présente notice, s'adressent exclusivement au personnel technique qualifié. Pour réduire les risques de chocs électriques, n'effectuer aucune intervention autre que celles décrites dans le mode d'emploi et les instructions relatives au fonctionnement, à moins que vous ne soyez qualifié pour ce faire.

<p>Remarque à l'attention de l'installateur du système</p> <p>Avec cet appareil, le blindage/écran du câble coaxial doit être mis à la terre aussi près que possible du point d'entrée du câble dans le bâtiment. En ce qui concerne les produits vendus aux États-Unis et au Canada, ce rappel est fourni pour attirer l'attention de l'installateur sur les articles 820-93 et 820-100 du Code national de l'électricité (ou Code de l'électricité canadien, Partie 1) qui fournissent des lignes directrices concernant la mise à la terre correcte du blindage (écran) du câble coaxial.</p>	<table border="1"><tr><td></td><td>CAUTION RISK OF ELECTRIC SHOCK DO NOT OPEN</td><td></td></tr><tr><td></td><td>ATTENTION DANGER ÉLECTRIQUE NE PAS OUVRIR</td><td></td></tr></table>		CAUTION RISK OF ELECTRIC SHOCK DO NOT OPEN			ATTENTION DANGER ÉLECTRIQUE NE PAS OUVRIR	
	CAUTION RISK OF ELECTRIC SHOCK DO NOT OPEN						
	ATTENTION DANGER ÉLECTRIQUE NE PAS OUVRIR						
<p></p> <p>Ce symbole a pour but de vous prévenir que des tensions électriques non isolées existent à l'intérieur de ce produit, pouvant être d'une intensité suffisante pour causer des chocs électriques. Il est donc dangereux d'établir un contact quelconque avec l'une des pièces comprises à l'intérieur de ce produit.</p>	<p>ATTENTION : Pour réduire les risques de chocs électriques, ne pas enlever le couvercle (ou le panneau arrière). Ne contient aucune pièce réparable par l'utilisateur. Confier les interventions aux techniciens d'entretien qualifiés.</p> <p>AVERTISSEMENT POUR ÉVITER LES INCENDIES OU LES CHOC ÉLECTRIQUES, NE PAS EXPOSER L'APPAREIL À LA PLUIE OU À L'HUMIDITÉ.</p> <p></p> <p>Ce symbole a pour but de vous prévenir de la présence d'instructions importantes relatives au fonctionnement ou à l'entretien (et aux réparations) dans la documentation accompagnant ce produit.</p>						

Mitteilung für CATV-Techniker

Die in dieser Mitteilung aufgeführten Wartungsanweisungen sind ausschließlich für qualifiziertes Fachpersonal bestimmt. Um die Gefahr eines elektrischen Schlags zu reduzieren, sollten Sie keine Wartungsarbeiten durchführen, die nicht ausdrücklich in der Bedienungsanleitung aufgeführt sind, außer Sie sind zur Durchführung solcher Arbeiten qualifiziert.

<p>Mitteilung an den Systemtechniker</p> <p>Für dieses Gerät muss der Koaxialkabelschutz/ Schirm so nahe wie möglich am Eintrittspunkt des Kabels in das Gebäude geerdet werden. Dieser Erinnerungshinweis liegt den in den USA oder Kanada verkauften Produkten bei. Er soll den Systemtechniker auf Paragraph 820-93 und Paragraph 820-100 der US-Elektrovorschrift NEC (oder der kanadischen Elektrovorschrift Canadian Electrical Code Teil 1) aufmerksam machen, in denen die Richtlinien für die ordnungsgemäße Erdung des Koaxialkabelschirms festgehalten sind.</p>	 <p>CAUTION RISK OF ELECTRIC SHOCK DO NOT OPEN</p> <p>ACHTUNG STROMSCHLAGEGFAHR, NICHT ÖFFNEN</p>
 <p>Dieses Symbol weist den Benutzer auf das Vorhandensein von nicht isolierten gefährlichen Spannungen im Gerät hin, die Stromschläge verursachen können. Ein Kontakt mit den internen Teilen dieses Produktes ist mit Gefahren verbunden.</p>	<p>ACHTUNG: Zur Vermeidung eines Stromschlags darf die Abdeckung (bzw. die Geräterückwand) nicht entfernt werden. Das Gerät enthält keine vom Benutzer wartbaren Teile. Wartungsarbeiten dürfen nur von qualifiziertem Fachpersonal durchgeführt werden.</p> <p>WARNUNG DAS GERÄT NICHT REGEN ODER FEUCHTIGKEIT AUSSETZEN, UM STROMSCHLAG ODER DURCH EINEN KURZSCHLUSS VERURSACHTEN BRAND ZU VERMEIDEN.</p>  <p>Dieses Symbol weist den Benutzer darauf hin, dass die mit diesem Produkt gelieferte Dokumentation wichtige Betriebs- und Wartungsanweisungen für das Gerät enthält.</p>

Aviso a los instaladores de sistemas CATV

Las instrucciones de reparación contenidas en el presente aviso son para uso exclusivo por parte de personal de mantenimiento cualificado. Con el fin de reducir el riesgo de descarga eléctrica, no realice ninguna otra operación de reparación distinta a las contenidas en las instrucciones de funcionamiento, a menos que posea la cualificación necesaria para hacerlo.

<p>Nota para el instalador del sistema</p> <p>En lo que se refiere a este aparato, el blindaje del cable coaxial debe conectarse a tierra lo más cerca posible al punto por el cual el cable entra en el edificio. En el caso de los productos vendidos en los EE. UU. y Canadá, el presente aviso se suministra para llamar la atención del instalador del sistema sobre los Artículos 820-93 y 820-100 del NEC (o Código Eléctrico de Canadá, Parte 1), que proporcionan directrices para una correcta conexión a tierra del blindaje del cable coaxial.</p>	 <p>CAUTION RISK OF ELECTRIC SHOCK DO NOT OPEN</p> <p>ATENCIÓN RIESGO DE DESCARGA ELÉCTRICA NO ABRIR</p>
 <p>Este símbolo tiene como fin advertirle de que una tensión sin aislamiento en el interior de este producto podría ser de una magnitud suficiente como para provocar una descarga eléctrica. Por consiguiente, resulta peligroso realizar cualquier tipo de contacto con alguno de los componentes internos de este producto.</p>	<p>ATENCIÓN: con el fin de reducir el riesgo de descarga eléctrica, no retire la tapa (ni la parte posterior). No existen en el interior componentes que puedan ser reparados por el usuario. Encargue su revisión a personal de mantenimiento cualificado.</p> <p>ADVERTENCIA PARA EVITAR EL RIESGO DE INCENDIO O DESCARGA ELÉCTRICA, NO EXPONGA LA UNIDAD A LA LLUVIA O A LA HUMEDAD.</p>  <p>Este símbolo tiene como fin alertarle de la presencia de importantes instrucciones de operación y mantenimiento (revisión) contenidas en la literatura que acompaña al producto.</p>

Contents

IMPORTANT SAFETY INSTRUCTIONS	v
United States FCC Compliance	viii
About This Guide	x
Introducing the DOCSIS 3.0 Wireless Residential Gateway	1
Introduction	2
What's In the Carton?	3
Front Panel Description	4
Back Panel Description	6
Top Panel Description.....	8
Installing the DOCSIS 3.0 Wireless Residential Gateway	9
Installation Preparations	10
Install the Wireless Residential Gateway	15
MoCA Installation Guidelines	18
Operation of Front Panel Indicators	21
Initial Power On, Calibration, and Registration (AC Power applied).....	22
Normal Operations (AC Power Applied)	23
Special Conditions	24
Troubleshooting the DOCSIS 3.0 Wireless Residential Gateway	25
Frequently Asked Questions	26
Common Troubleshooting Issues	31
Tips for Improved Performance	32
Customer Information	33

IMPORTANT SAFETY INSTRUCTIONS

- 1) Read these instructions.
- 2) Keep these instructions.
- 3) Heed all warnings.
- 4) Follow all instructions.
- 5) Do not use this apparatus near water.
- 6) Clean only with dry cloth.
- 7) Do not block any ventilation openings. Install in accordance with the manufacturer's instructions.
- 8) Do not install near any heat sources such as radiators, heat registers, stoves, or other apparatus (including amplifiers) that produce heat.
- 9) Do not defeat the safety purpose of the polarized or grounding-type plug. A polarized plug has two blades with one wider than the other. A grounding-type plug has two blades and a third grounding prong. The wide blade or the third prong is provided for your safety. If the provided plug does not fit into your outlet, consult an electrician for replacement of the obsolete outlet.
- 10) Protect the power cord from being walked on or pinched particularly at plugs, convenience receptacles, and the point where they exit from the apparatus.
- 11) Only use attachments/accessories specified by the manufacturer.
- 12) Use only with the cart, stand, tripod, bracket, or table specified by the manufacturer, or sold with the apparatus. When a cart is used, use caution when moving the cart/apparatus combination to avoid injury from tip-over.
- 13) Unplug this apparatus during lightning storms or when unused for long periods of time.
- 14) Refer all servicing to qualified service personnel. Servicing is required when the apparatus has been damaged in any way, such as a power-supply cord or plug is damaged, liquid has been spilled or objects have fallen into the apparatus, the apparatus has been exposed to rain or moisture, does not operate normally, or has been dropped.



Power Source Warning

A label on this product indicates the correct power source for this product. Operate this product only from an electrical outlet with the voltage and frequency indicated on the product label. If you are uncertain of the type of power supply to your home or business, consult your service provider or your local power company.

The AC inlet on the unit must remain accessible and operable at all times.

Ground the Product



WARNING: Avoid electric shock and fire hazard! If this product connects to coaxial cable wiring, be sure the cable system is grounded (earthed). Grounding provides some protection against voltage surges and built-up static charges.

Protect the Product from Lightning

In addition to disconnecting the AC power from the wall outlet, disconnect the signal inputs.

Verify the Power Source from the On/Off Power Light

When the on/off power light is not illuminated, the apparatus may still be connected to the power source. The light may go out when the apparatus is turned off, regardless of whether it is still plugged into an AC power source.

Eliminate AC Power/Mains Overloads



WARNING: Avoid electric shock and fire hazard! Do not overload AC power/mains, outlets, extension cords, or integral convenience receptacles. For products that require battery power or other power sources to operate them, refer to the operating instructions for those products.

Provide Ventilation and Select a Location

- Remove all packaging material before applying power to the product.
- Do not place this apparatus on a bed, sofa, rug, or similar surface.
- Do not place this apparatus on an unstable surface.
- Do not install this apparatus in an enclosure, such as a bookcase or rack, unless the installation provides proper ventilation.
- Do not place entertainment devices (such as VCRs or DVDs), lamps, books, vases with liquids, or other objects on top of this product.
- Do not block ventilation openings.

Operating Environment

This product is designed for operation indoors with a temperature range from 32° to 104° F (0° to 40°C). Each product should have adequate spacing on all sides so that the cooling air vents on the chassis are not blocked.

Protect from Exposure to Moisture and Foreign Objects



WARNING: Avoid electric shock and fire hazard! Do not expose this product to dripping or splashing liquids, rain, or moisture. Objects filled with liquids, such as vases, should not be placed on this apparatus.



WARNING: Avoid electric shock and fire hazard! Unplug this product before cleaning. Do not use a liquid cleaner or an aerosol cleaner. Do not use a magnetic/static cleaning device (dust remover) to clean this product.



WARNING: Avoid electric shock and fire hazard! Never push objects through the openings in this product. Foreign objects can cause electrical shorts that can result in electric shock or fire.

Service Warnings



WARNING: Avoid electric shock! Do not open the cover of this product. Opening or removing the cover may expose you to dangerous voltages. If you open the cover, your warranty will be void. This product contains no user-serviceable parts.

Check Product Safety

Upon completion of any service or repairs to this product, the service technician must perform safety checks to determine that this product is in proper operating condition.

Protect the Product When Moving It

Always disconnect the power source when moving the apparatus or connecting or disconnecting cables.

United States FCC Compliance

This device has been tested and found to comply with the limits for a Class B digital device, pursuant to part 15 of the FCC Rules. These limits are designed to provide reasonable protection against such interference in a residential installation. This equipment generates, uses, and can radiate radio frequency energy. If not installed and used in accordance with the instructions, it may cause harmful interference to radio communications. However, there is no guarantee that interference will not occur in a particular installation. If this equipment does cause harmful interference to radio or television reception, which can be determined by turning the equipment OFF and ON, the user is encouraged to try to correct the interference by one or more of the following measures:

- Reorient or relocate the receiving antenna.
- Increase the separation between the equipment and receiver.
- Connect the equipment into an outlet on a circuit different from that to which the receiver is connected.
- Consult the service provider or an experienced radio/television technician for help.

Any changes or modifications not expressly approved by Cisco Systems, Inc., could void the user's authority to operate the equipment.

The information shown in the FCC Declaration of Conformity paragraph below is a requirement of the FCC and is intended to supply you with information regarding the FCC approval of this device. *The phone numbers listed are for FCC-related questions only and not intended for questions regarding the connection or operation for this device. Please contact your service provider for any questions you may have regarding the operation or installation of this device.*

FC Declaration of Conformity

This device complies with Part 15 of FCC Rules. Operation is subject to the following two conditions: 1) the device may not cause harmful interference, and 2) the device must accept any interference received, including interference that may cause undesired operation.

DOCSIS 3.0 Wireless Residential Gateway Model(s): DPC3848 DPC3848V DPC3848VM Manufactured by: Cisco Systems, Inc. 170 West Tasman Drive San Jose, California 95134 USA

Canada EMI Regulation

This Class B digital apparatus complies with Canadian ICES-003.

Cet appareil numérique de la class B est conforme à la norme NMB-003 du Canada.

2.4 G and 5 G Wi-Fi

The equipment operates in the 2400-to-2483.5 MHz, the 5150-to-5350 MHz, and the 5470-to-5725 MHz frequency range.

RF Exposure Statements

Note: This transmitter must not be co-located or operated in conjunction with any other antenna or transmitter. This equipment should be installed and operated with a minimum distance of 7.9 inches (20 cm) between the radiator and your body. For products available in the USA/Canada market, only channels 1-11 can be operated. The selection of other channels is not possible.

US

This system has been evaluated for RF exposure for humans in reference to ANSI C 95.1 (American National Standards Institute) limits. The evaluation was based in accordance with FCC OET Bulletin 65C rev 01.01 in compliance with Part 2.1091 and Part 15.27. The minimum separation distance from the antenna to general bystander is 7.9 inches (20 cm) to maintain compliance.

Canada

This system has been evaluated for RF exposure for humans in reference to Canada Health Code 6 (2009) limits. The evaluation was based on evaluation per RSS-102 Rev 4. The minimum separation distance from the antenna to general bystander is 7.9 inches (20 cm) to maintain compliance.

About This Guide

Introduction

Welcome. This guide provides instructions and recommendations for placing, installing, configuring, operating, maintaining, and troubleshooting the DPC3848, DPC3848V, and DPC3848VM DOCSIS 3.0 Wireless Residential Gateways.

Purpose

This guide covers the following product models:

- DPC3848 DOCSIS 3.0 Wireless Residential Gateway
- DPC3848V DOCSIS 3.0 Wireless Residential Gateway
- DPC3848VM DOCSIS 3.0 Wireless Residential Gateway

All features described in this guide are standard to these models of residential gateways unless otherwise noted. For the purpose of this guide, whenever a feature or option applies to only a specific model, the model number is specified. If a model number is not specified, then the feature or option applies to all of the models.

Audience

This guide is written for the home subscriber.

Document Version

This is the first formal release of this document.

1

Introducing the DOCSIS 3.0 Wireless Residential Gateway

Introduction

This chapter provides an overview of residential gateway features, indicators, and connectors to help you become familiar with the residential gateway and the benefits it offers. This chapter also lists the accessories and equipment that are provided with the residential gateway so that you can verify that you received all of these items.

In This Chapter

■ Introduction.....	2
■ What's In the Carton?.....	3
■ Front Panel Description	4
■ Back Panel Description	6
■ Top Panel Description.....	8

Introduction

Your new Cisco® Model DPC3848, DPC3848V, or DPC3848VM DOCSIS 3.0 Wireless Residential Gateway is a high-performance home gateway that combines a cable modem, router, and wireless access point(s) in a single device, providing a cost-effective networking solution for both the home and small office.

This guide provides procedures and recommendations for placing, installing, configuring, operating, and troubleshooting your residential gateway. Refer to the appropriate section in this guide for the specific information you need for your situation. Contact your service provider for more information about subscribing to these services.

Your new residential gateway offers the following outstanding benefits and features:

- Compliant with DOCSIS 3.0, 2.0, and 1.x standards to deliver high-end performance and reliability
- High performance broadband Internet connectivity to energize your online experience
- (Optional) Multimedia over Coax Alliance (MoCA) networking over coaxial cable in the home
- Four 1000/100/10BASE-T Ethernet ports to provide wired connectivity
- Dual-band concurrent 802.11n Wireless Access Point (WAP) with eight Service Set Identifiers (SSIDs) compatible with 802.11b/g/n and optional 802.11ac
- Wireless Protected Setup (WPS), including a pushbutton switch to activate WPS for simplified and secure wireless setup
- User configurable Parental Control blocks access to undesirable Internet sites
- Advanced firewall technology deters hackers and protects the home network from unauthorized access
- Attractive compact design and versatile orientation to stand vertically on a desk or shelf, or mount easily to a wall
- Color-coded interface ports and corresponding cables simplify installation and setup
- DOCSIS-compliant LED labeling and behavior provides a user and technician friendly method to check operational status and act as a troubleshooting tool
- Allows automatic software upgrades by your service provider

What's In the Carton?

When you receive your residential gateway, you should check the equipment and accessories to verify that each item is in the carton and that each item is undamaged. The carton contains the following items:



One DPC3848, DPC3848V, or DPC3848VM DOCSIS 3.0 Wireless Residential Gateway



One AC power cord (Image may vary from product. Item varies based on the region where the item is used.)



One Ethernet cable (May not be provided with all products.)

If any of these items are missing or damaged, please contact your service provider for assistance.

Note: You need an optional cable signal splitter and additional standard RF coaxial cables if you want to connect a Digital Home Communications Terminal (DHCT), a set-top converter, or a TV to the same cable connection as your residential gateway.

Front Panel Description

The front panel of your residential gateway provides LED status indicators that indicate how well and at what state your residential gateway is operating. See *Operation of Front Panel Indicators* (on page 21), for more information on front panel LED status indicator functions.

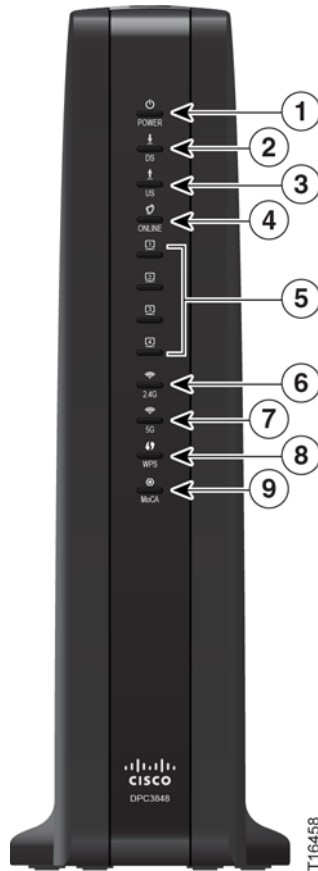

- 1 **POWER**—ON, power is applied to the residential gateway
- 2 **DS**—ON, the residential gateway is receiving data from the cable network
- 3 **US**—ON, the residential gateway is sending data to the cable network
- 4 **ONLINE**—ON, the residential gateway is registered on the network and fully operational
- 5 **1-4**—ON, a device is connected to the Ethernet port. Blinking indicates that data is being transferred over the Ethernet connection
- 6 **2.4G**—ON, the wireless access point is operational. Blinking indicates that data is being transferred over the wireless connection. OFF indicates that the wireless access point is not enabled
- 7 **5G**—ON, the wireless access point is operational. Blinking indicates that data is being transferred over the wireless connection. OFF indicates that the wireless access point is not enabled

- 8 **WPS** –OFF (normal condition), indicates that the wireless setup is not active. Blinking indicates the user has activated wireless setup to add new WPS clients on the wireless network
- 9 **MoCA** (Optional) –ON, indicates an active MoCA device is connected. Blinking indicates that data is being transferred over the MoCA network. (Available only with the model DPC3848VM)

Back Panel Description

The following illustration identifies the back panel components on the residential gateway. Descriptions for each component follow the illustration.

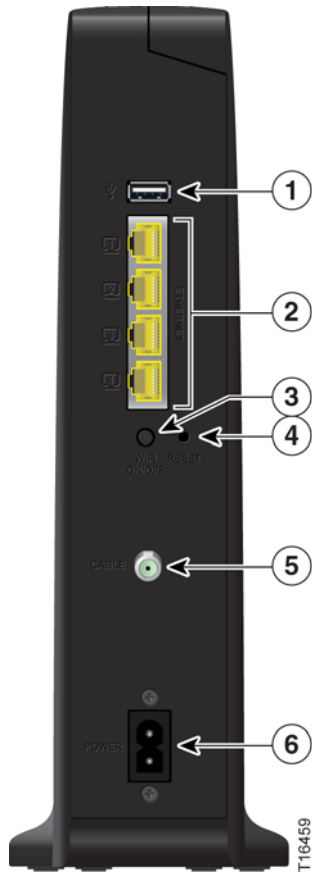

Important: Do not connect your PC to both the Ethernet and USB ports at the same time. Your residential gateway will not function properly if both the Ethernet and USB ports are connected to your PC at the same time.

- 1 USB (Optional for some models)**—Connects to selected devices. For models that support USB, the default is one USB port
- 2 ETHERNET**—Four RJ-45 Ethernet ports connect to the Ethernet port on your PC or your home network
- 3 WIFI ON/OFF**—This button may be administratively disabled by your service provider. When this button is enabled, momentarily pressing this switch once for 1 to 2 seconds will turn off the 2.4G transmitter when both Wi-Fi transmitters are on. Momentarily pressing it a second time turns off the 5G transmitter. Momentarily pressing it a third time turns on both the 2.4G and 5G transmitters

- 4 **RESET**—A momentary pressing (1-2 seconds) of this button performs a software reset the device. Pressing and holding the button for more than ten seconds first causes a reset-to-factory-default of all settings and then performs a software reset of the device



CAUTION:

The **RESET** button is for maintenance purposes only. Do not use unless instructed to do so by your service provider. Doing so may cause you to lose any settings you have selected.

- 5 **CABLE**—F-connector connects to an active cable signal from your service provider
- 6 **POWER**—Connects the residential gateway to the AC wall outlet

Top Panel Description

The WPS button on the top panel of the residential gateway shows the status of the Wireless Protected Setup (WPS) and Page features.

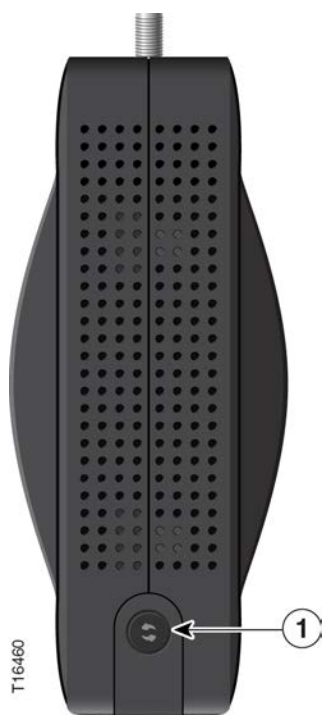

- 1 WIRELESS SETUP Button** – Press this button to activate the Wireless Setup feature. This feature allows users to add new Wireless Protected Setup (WPS) compliant wireless clients to the home network.

2

Installing the DOCSIS 3.0 Wireless Residential Gateway

Introduction

This chapter describes how to properly install the residential gateway and connect the residential gateway to a computer and other devices.

In This Chapter

- Installation Preparations10
- Install the Wireless Residential Gateway15
- MoCA Installation Guidelines18

Installation Preparations

Before installing the residential gateway, make sure that your system meets or exceeds the requirements listed in this section. Also, make sure that you have prepared your home and home devices as described in this section.

What Are the System Requirements for Internet Service?

To ensure that your residential gateway operates efficiently for high-speed Internet service, you must have an Internet-capable PC, Mac, or Internet appliance equipped with an Ethernet port or Wi-Fi capability.

Note: You will also need an active cable input line and an Internet connection.

What Types of Service Accounts Do I Need?

Depending upon the features that your service provider offers, you may need to establish one or both of the following accounts:

- A high-speed Internet access account, if your residential gateway supports an Internet connection
- An account for telephone service, if your residential gateway supports digital telephone service

Refer to one of the following topics to learn more about the types of service accounts that you may need to establish.

High-Speed Internet Access Account

If you do *not* have a high-speed Internet access account, your service provider will set up your account and become your Internet service provider (ISP). Internet access enables you to send and receive email, access the World Wide Web, and receive other Internet services.

You will need to give your service provider information about the residential gateway to use the high-speed Internet feature that this product offers. See *Information Your Service Provider Needs* (on page 11) to learn how to locate the information your service provider needs to establish a high-speed Internet access account for the residential gateway

I Already Have a High-Speed Internet Access Account

If you have an existing high-speed Internet access account, you will need to give your service provider the serial number and MAC address of the residential gateway to use the high-speed Internet feature that this product offers. See *Information Your Service Provider Needs* (on page 11) to learn how to locate this information.

Information Your Service Provider Needs

You will need to give your service provider the following information, which is printed on the bar code label attached to the device:

- The Serial Number (S/N) of the residential gateway. The serial number consists of a series of nine digits.
- The Wide-Area Network (WAN) Media Access Control (MAC) address of the residential gateway. The WAN MAC address consists of a series of 12 alphanumeric characters.
- The Cable Modem (CM) MAC address of the residential gateway media terminal adapter (CM MAC). The CM MAC address consists of a series of 12 alphanumeric characters.

The following illustration shows a typical bar coded label; the image may vary from the label on the actual product.

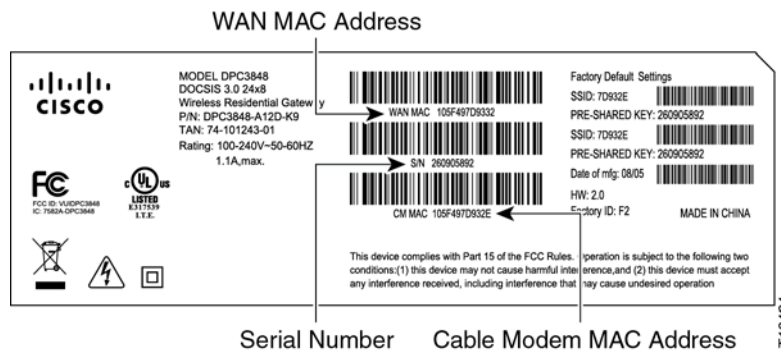

Write down these numbers in the spaces provided:

Serial Number _____

WAN MAC Address _____

CM MAC Address _____

Where Is the Best Location for My Wireless Residential Gateway?

The ideal location for your residential gateway is where it has access to outlets and other devices. Think about the layout of your home or office, and consult with your service provider to select the best location for your residential gateway. Read this user guide thoroughly before you decide where to place your residential gateway.

Consider these recommendations:

- Choose a location close to your computer if you will also use the residential gateway for high-speed Internet service.
- Choose a location that is near an existing RF coaxial connection to eliminate the need for an additional RF coaxial outlet.
- Choose a location that is relatively protected from accidental disturbance or harm, such as a closet, basement, or other protected area.
- Choose a location so that there is plenty of room to guide the cables away from the residential gateway without straining or crimping them.
- Choose a location that allows adequate ventilation around the residential gateway.

How Do I Mount the Wireless Residential Gateway on a Wall? (Optional)

Your residential gateway may include mounting holes so that, if you wish, you can mount the residential gateway to a wall. This section describes how to mount the residential gateway to a wall, and includes a list of the equipment that you will need along with suggestions for choosing an appropriate place to mount the residential gateway.

Select an Appropriate Place to Mount the Wireless Residential Gateway

You may mount the residential gateway to a wall that is made of cement, wood, or drywall. When choosing an appropriate mounting place, refer to the following recommendations:

- Ensure that the mounting location is free of obstructions on all sides, and the cables should be able to easily reach the residential gateway without strain.
- Leave sufficient clearance between the bottom of the residential gateway and any flooring or shelving underneath to allow access to cabling.
- Allow enough slack in all cables so that the residential gateway can be removed for any required maintenance without disconnecting the cables.
- Choose a location that allows adequate ventilation around the residential gateway.

Equipment Needed

Verify that you have the following items that you will need to mount the residential gateway:

- Two wall anchors for #8 x 1-inch screws
- Two #8 x 1-inch pan head sheet metal screws

- Drill with a 3/16-in. wood or masonry bit, as appropriate for the wall composition
- A copy of the wall-mounting illustrations shown on the following pages

Location and Dimensions of the Wall-Mounting Slots

The following illustration shows the location and dimensions of the wall-mounting slots on the side of the residential gateway. Use this illustration as a guide for mounting the residential gateway to the wall.

Note: Image not to scale.

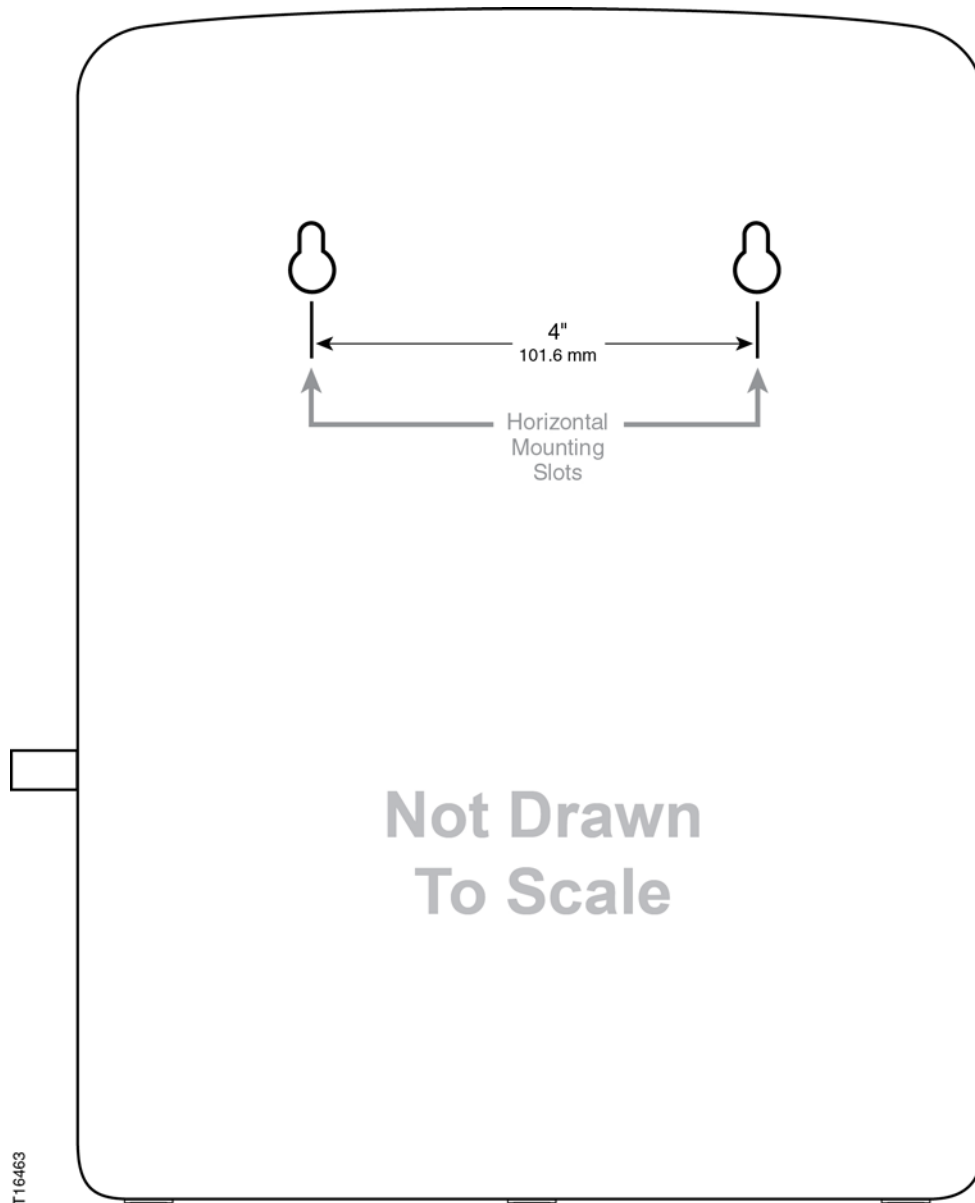

Mounting the Wireless Residential Gateway on a Wall

- 1 Using a drill with a 3/16-inch bit, drill two holes at the same height and 4 inches apart.

Note: The preceding graphic illustrates the location of the mounting holes on the back of the residential gateway.

- 2 Are you mounting the residential gateway into a drywall or concrete surface where a wooden stud is available?
 - If **yes**, go to Step 3.
 - If **no**, drive the anchor bolts into the wall, and install the mounting screws into the anchor bolts; leave a gap of about 1/2-inch between the screw head and the wall. Then, go to Step 4.
- 3 Install the mounting screws into the wall; leave a gap of about 1/2-inch between the screw head and the wall. Then, go to Step 4.
- 4 Verify that no cables or wires are connected to the residential gateway.
- 5 Lift the residential gateway into position. Slip the large end of both mounting slots (located in the side of the residential gateway) over the mounting screws, and then slide the residential gateway down until the narrow end of the keyhole slot contacts the screw shaft.

Important: Verify that the mounting screws securely support the residential gateway before you release the unit.

Install the Wireless Residential Gateway

This section describes how to connect your residential gateway to support the services that the residential gateway offers.

Connect Devices to the Wireless Residential Gateway

The following illustration shows all of the possible connections that can be made to your residential gateway for various services. Although your model may not support all of the services pictured, you can determine which services your model supports by referring to the Benefits and Features list in *Introduction* (on page 2).

Notes:

- Professional installation may be available. Contact your local service provider for further assistance.
- Device image varies according to model.

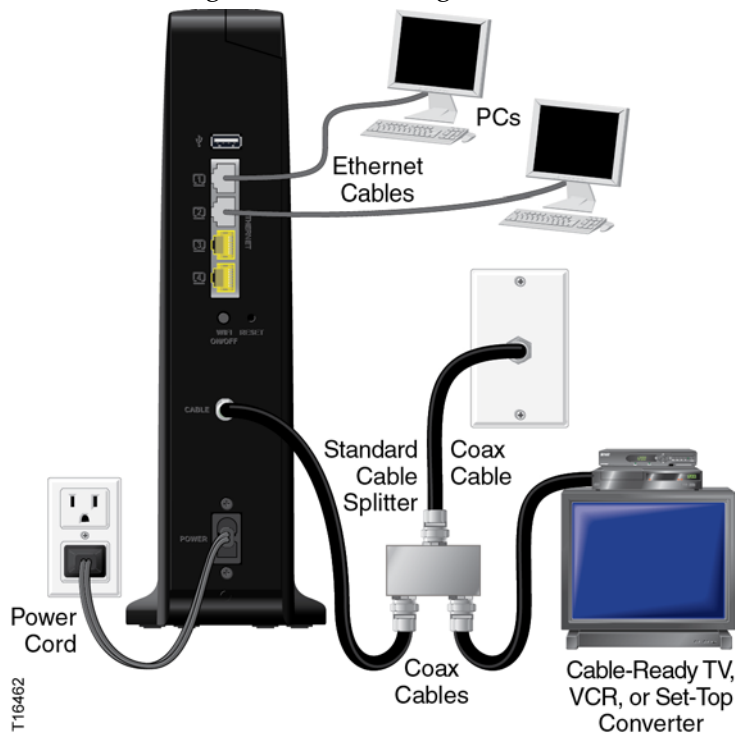

Connect the Wireless Residential Gateway

The following installation procedure ensures proper setup and configuration for the residential gateway.

- 1 Choose an appropriate and safe location to install the residential gateway (close to a power source, an active cable connection, your PC-if using high-speed Internet, and your telephone lines-if using VoIP). For assistance, refer to *Where Is the Best Location for My Wireless Residential Gateway?* (on page 11). For a MoCA installation, also see *Recommended MoCA Installation Guidelines* (on page 18).



WARNING:

- To avoid personal injury, follow the installation instructions in the exact order shown.
- Wiring and connections must be properly insulated to prevent electrical shock.
- Disconnect power from the residential gateway before attempting to connect to any device.

- 2 Power off your PC and other networking device; then, unplug them from the power source.
- 3 Connect the active RF coaxial cable from your service provider to the coax connector labeled **CABLE** on the back of the residential gateway.

Note: To connect a TV, DHCT, set-top, or VCR from the same cable connection, you will need to install a cable signal splitter (not included). Always check with your service provider before using a splitter as a splitter may degrade the signal.

For more information about a MoCA installation, see *MoCA Installation Guidelines* (on page 18).

- 4 Connect your PC to the residential gateway using one of the following methods:
 - **Ethernet Connection.** Connect one end of an Ethernet cable to the Ethernet port on your PC, and connect the other end to the **Ethernet** port on the back of the residential gateway.
 - **Wireless Connection.** Make sure that your wireless device is powered up. You will need to associate your wireless device with the residential gateway once the residential gateway is operational. Follow the directions provided with your wireless device for associating with a wireless access point. Make sure that either the **2.4G** or the **5G** indicator is ON.

- 5 Locate the AC power cord provided with your residential gateway. Connect the barrel connector end of the power cord into the power input on the back of the residential gateway. Then, plug the other end of the power cord into an AC outlet.

The residential gateway will perform an automatic search to locate and sign on to the broadband data network. This process may take up to 2-5 minutes. The residential gateway will be ready for use when the **Power**, **US/DS**, and **Online** LEDs on the front panel of the residential gateway stop blinking and remain on continuously.

- 6 Plug in and power on your PC and other home network devices. If one or more of these devices uses wireless networking, the **2.4G** or **5G** LED on the residential gateway should be on or blinking.

- 7 At this point, the installation is complete, and you can begin surfing the Internet.

Note: If your PC does not have Internet access, refer to *How Do I Configure TCP/IP Protocol?* (on page 26) for information on how to configure your PC for TCP/IP. For Internet devices other than PCs, refer to the DHCP or IP Address configuration section of the User Guide or Operations Manual for those devices.

MoCA Installation Guidelines

MoCA is an in-home distribution technology that leverages the coax cable networks that exist in more than 90% of US households. MoCA is an attractive option because it provides a relatively low-cost method of getting DVR and other multimedia sharing video services to multiple TVs within the home without additional cable installation.



MoCA operates over the physical layer of the home coaxial cable plant in the 1000-1500 MHz spectrum. Its infrastructure begins at the service provider's drop cable at the first passive splitter connected to the home coax network.

Recommended MoCA Installation Guidelines

The following guidelines are recommended for a home network prior to installation.

- The maximum cable distance supported between the network coordinator and the last outlet is 300 feet.
- The maximum attenuation permitted between nodes is 25 dB.
- Branches within the home-network should flow from secondary splitters.
- Assess the home network and determine the data rates between coax outlets.
- Sectionalize the individual MoCA nodes to validate proper operation of the device's MoCA interface.
- Evaluate and certify the integrity of the coax cable plant between MoCA nodes.

- Identify sources of noise and interference on the MoCA spectrum.
- Re-qualify additional coax outlets to support MoCA-enabled devices and services.

Pre-Installation Instructions

Prior to installing MoCA, complete the following tasks:

- 1 Contact your service provider and ensure that the residential gateway is enabled for MoCA services.
- 2 Ensure that a MoCA filter has been installed by your service provider at the home's entry point, as shown in the following illustration:

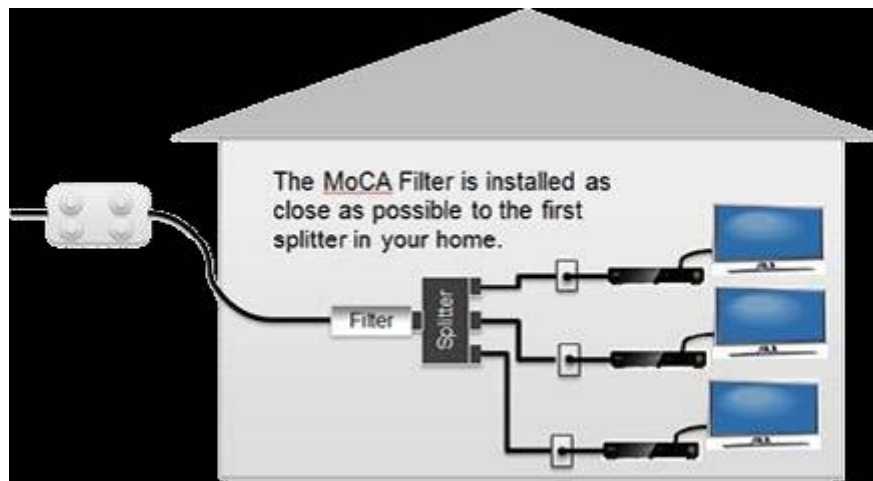

- 3 To log in to the residential gateway, enter <http://192.168.0.1> in the web address (URL) field of any browser and press the **Enter** key. Then enter the username and password when prompted.
- 4 From the menu options, go to **Gateway/Connections/MoCA** and ensure that MoCA is set to **enable**.
- 5 If you have not already done so, connect the coaxial cable from a wall cable outlet within the home network to the **Cable** port on the rear panel of the residential gateway.
- 6 If you have not already done so, connect the AC power cord provided with your residential gateway. Connect the barrel connector end of the power cord into the power input on the back of the residential gateway. Then, plug the other end of the power cord into an AC outlet.

The residential gateway will perform an automatic search to locate and sign on to the broadband data network. This process may take up to 2-5 minutes. The residential gateway will be ready for use when the **Power**, **US/DS**, and **Online** LEDs on the front panel of the residential gateway stop blinking and remain on continuously.

Chapter 2 Installing the DOCSIS 3.0 Wireless Residential Gateway

- 7 Wait a few seconds for the device to be discovered. When discovered, an LED labeled **MoCA** should turn on. At this point, a MoCA node should be active in the network.
- 8 If you have not already done so, connect an Ethernet compatible device (for example, a set-top, computer, or PlayStation) to the Ethernet port on the residential gateway. The **ONLINE** LED should turn on and the device should be ready to use.
- 9 Follow the steps above to connect additional residential gateways to the network; note that up to 15 residential gateways can be added to a MoCA network.
- 10 From the user interface, you can monitor a limited number of parameters associated with the MoCA network. You may login at any time to check for status or for troubleshooting purposes.

3

Operation of Front Panel Indicators

Introduction

This chapter describes the behavior of the front panel indicators when the residential gateway is first powered up, during normal operations, and in special conditions.

In This Chapter

- Initial Power On, Calibration, and Registration (AC Power applied)22
- Normal Operations (AC Power Applied)23
- Special Conditions24

Initial Power On, Calibration, and Registration (AC Power applied)

Writers: Duplicate this object and remove the original object from your book object. Rename the topic description with the part number of your user guide.

The following chart illustrates the sequence of steps and the corresponding appearance of the residential gateway front panel LED status indicators during power up, calibration, and registration on the network when AC power is applied to the residential gateway. Use this chart to troubleshoot the power up, calibration, and registration process of your residential gateway.

Note: After the residential gateway completes Step 7 (Data Network Registration Complete), the residential gateway proceeds immediately to Normal Operations. See *Normal Operations (AC Power applied)* (on page 23).

Front Panel LED Status Indicators During Initial Power Up, Calibration, and Registration								
		Part 1, High Speed Data Registration						
Step:		1	2	3	4	5	6	7
Front Panel Indicator		Self Test	Downstream Scan	Downstream Signal Lock	Ranging	Requesting IP Address	Request High Speed Data Provisioning File	Data Network Registration Complete
1	POWER	On	On	On	On	On	On	On
2	DS	On	Blinking	On	On	On	On	On
3	US	On	Off	Off	Blinking	On	On	On
4	ONLINE	On	Off	Off	Off	Off	Blinking	On
5	ETHERNET 1-4	On	On or Blinking	On or Blinking	On or Blinking	On or Blinking	On or Blinking	On
6	2.4G	On	Blinking or Fast Blinking	Blinking or Fast Blinking	Blinking or Fast Blinking	Blinking or Fast Blinking	Blinking or Fast Blinking	Blinking
7	5G	On	Blinking or Fast Blinking	Blinking or Fast Blinking	Blinking or Fast Blinking	Blinking or Fast Blinking	Blinking or Fast Blinking	Blinking
8	WPS	Off	Off or Blinking	Off or Blinking	Off or Blinking	Off or Blinking	Off or Blinking	Off
9	MoCA (Optional)	Off	Off, On, or Blinking	Off, On, or Blinking	Off, On, or Blinking	Off, On, or Blinking	Off, On, or Blinking	On

Normal Operations (AC Power Applied)

The following chart illustrates the appearance of the residential gateway front panel LED status indicators during normal operations when AC power is applied to the gateway.

Front Panel LED Status Indicators During Normal Conditions		
Front Panel Indicator		Normal Operations
1	POWER	On
2	DS	On
3	US	On
4	ONLINE	On
5	ETHERNET 1-4	<ul style="list-style-type: none"> ■ On - When a device is connected to an Ethernet port and no data is being sent to or from the residential gateway ■ Blinks - When an Ethernet device is connected and data is being transferred between the consumer premise equipment (CPE) and the wireless home gateway ■ Off - When no devices are connected to the Ethernet ports
6	2.4G	<ul style="list-style-type: none"> ■ Blinks - When the wireless access point is enabled and operational ■ Fast Blinks - When data is being transferred between the CPE and the wireless home gateway ■ Off - When the wireless access point is disabled by the user
7	5G	<ul style="list-style-type: none"> ■ Blinks - When the wireless access point is enabled and operational ■ Fast Blinks - When data is being transferred between the CPE and the wireless home gateway ■ Off - When the wireless access point is disabled by the user
8	WPS	<ul style="list-style-type: none"> ■ Off - When wireless setup is not active ■ Blinks - When wireless setup is active to add new wireless clients on the wireless network
9	MoCA (Optional)	<ul style="list-style-type: none"> ■ On - When MoCA devices are detected ■ Blinks - When MoCA data activity is present ■ Off - When no MoCA devices are detected

Note: In addition to the status shown in the previous table, some service providers use color-coded LEDs to indicate detailed channel bonding and data link status. For additional information about color-coded LEDs, check with your service provider.

Special Conditions

The following chart describes the appearance of the residential gateway front panel LED status indicators during special conditions to show when you have been denied network access.

Front Panel LED Status Indicators During Special Conditions		
Front Panel Indicator		Network Access Denied
1	POWER	On
2	DS	Flashes in unison with the US indicator (twice per second)
3	US	Flashes in unison with the DS indicator (twice per second)
4	ONLINE	Off
5	ETHERNET 1-4	Off - No CPE connected On - CPE connected Flash - CPE data activity
6	2.4G	Slow Blinking (once per second)
7	5G	Slow Blinking (once per second)
8	WPS	Slow Blinking (once per second)
9	MoCA (Optional)	On, Off, or Blinking

4

Troubleshooting the DOCSIS 3.0 Wireless Residential Gateway

Introduction

This chapter describes the most common issues that may occur after the residential gateway is installed and provides possible solutions and tips for improved performance of the residential gateway.

In This Chapter

- Frequently Asked Questions26
- Common Troubleshooting Issues31
- Tips for Improved Performance32

Frequently Asked Questions

This section provides answers to common questions about the residential gateway.

How Do I Configure TCP/IP Protocol?

To configure TCP/IP protocol, you need to have an Ethernet Network Interface Card (NIC) with TCP/IP communications protocol installed on your system. TCP/IP is a communications protocol used to access the Internet. This section contains instructions for configuring TCP/IP on your Internet devices to operate with the residential gateway in Microsoft Windows or Macintosh environments.

TCP/IP protocol in a Microsoft Windows environment is different for each operating system. Follow the appropriate instructions in this section for your operating system.

Configuring TCP/IP on Windows 7 Systems

- 1 Open **Network Connections** by clicking the **Start** button, and then clicking **Control Panel**.
- 2 In the Search field, type **adapter**, and then, under **Network and Sharing Center**, click **View network connections**.
- 3 Right-click the connection that you want to change, and then click **Properties**. If you are prompted for an administrator password or confirmation, type the password or provide confirmation. The Local Area Connection Properties window appears.
- 4 Click the **Networking** tab.
- 5 Under **This connection uses the following items**, click either **Internet Protocol Version 4 (TCP/IPv4)** or **Internet Protocol Version 6 (TCP/IPv6)**, and then click **Properties**.
- 6 To specify IPv4 IP address settings, do one of the following:
 - To get IP settings automatically using DHCP, click **Obtain an IP address automatically**, and then click **OK**.
 - To specify an IP address, click **Use the following IP address**, and then, in the **IP address**, **Subnet mask**, and **Default gateway** fields, type the IP address settings.
- 7 To specify IPv6 IP address settings, do one of the following:
 - To get IP settings automatically using DHCP, click **Obtain an IPv6 address automatically**, and then click **OK**.
 - To specify an IP address, click **Use the following IPv6 address**, and then, in the **IPv6 address**, **Subnet prefix length**, and the **Default gateway** fields, type the IP address settings.

- 8 To specify DNS server address settings, do one of the following:
 - To get a DNS server address automatically using DHCP, click **Obtain DNS server address automatically**, and then click **OK**.
 - To specify a DNS server address, click **Use the following DNS server addresses**, and then, in the **Preferred DNS server** and **Alternate DNS server** fields, type the addresses of the primary and secondary DNS servers.
- 9 To change advanced DNS, WINS, and IP settings, click **Advanced**.
- 10 When you are finished, click **OK**.
- 11 Try to access the Internet. If you cannot access the Internet, contact your service provider for further assistance.

Configuring TCP/IP on Windows XP Systems

- 1 Click **Start**, and depending on your Start menu setup, choose one of the following options:
 - If you are using the Windows XP Default Start menu, choose **Connect to**, choose **Show all connections**, and then go to Step 2.
 - If you are using the Windows XP Classic Start menu, select **Settings**, choose **Network Connections**, click **Local Area Connection**, and then go to Step 3.
- 2 Double-click the **Local Area Connection** icon in the LAN or High-Speed Internet section of the Network Connections window.
- 3 Click **Properties** in the Local Area Connection Status window.
- 4 Click **Internet Protocol (TCP/IP)**, and then click **Properties** in the Local Area Connection Properties window.
- 5 Select both **Obtain an IP address automatically** and **Obtain DNS server address automatically** in the Internet Protocol (TCP/IP) Properties window, and then click **OK**.
- 6 Click **Yes** to restart your computer when the Local Network window appears. The computer restarts. The TCP/IP protocol is now configured on your PC, and your Ethernet devices are ready for use.
- 7 Try to access the Internet. If you cannot access the Internet, contact your service provider for further assistance.

Configuring TCP/IP on Macintosh Systems

- 1 Click the **Apple** icon in the upper-left corner of the Finder. Scroll down to **Control Panels**, and then click **TCP/IP**.
- 2 Click **Edit** on the Finder at the top of the screen. Scroll down to the bottom of the menu, and then click **User Mode**.
- 3 Click **Advanced** in the User Mode window, and then click **OK**.
- 4 Click the Up/Down selector arrows located to the right of the Connect Via section of the TCP/IP window, and then click **Using DHCP Server**.

- 5 Click **Options** in the TCP/IP window, and then click **Active** in the TCP/IP Options window.
Note: Make sure that the **Load only when needed option** is *unchecked*.
- 6 Verify that the **Use 802.3** option located in the upper-right corner of the TCP/IP window is unchecked. If there is a check mark in the option, uncheck the option, and then click **Info** in the lower-left corner.
- 7 Is there a Hardware Address listed in this window?
 - If **yes**, click **OK**. To close the TCP/IP Control Panel window, click **File**, and then scroll down to click **Close**. You have completed this procedure.
 - If **no**, you must power off your Macintosh.
- 8 With the power off, simultaneously press and hold down the **Command (Apple)**, **Option**, **P**, and **R** keys on your keyboard. Keeping those keys pressed down, power on your Macintosh but do not release these keys until you hear the Apple chime at least three times, then release the keys and let the computer restart.
- 9 When your computer fully reboots, repeat Steps 1 through 7 to verify that all TCP/IP settings are correct. If your computer still does not have a Hardware Address, contact your authorized Apple dealer or Apple technical support center for further assistance.

How Do I Renew the IP Address on My PC?

If your PC cannot access the Internet after the residential gateway is online, it is possible that your PC did not renew its IP address. Follow the appropriate instructions in this section for your operating system to renew the IP address on your PC.

Renewing the IP Address on Windows 7 Systems

- 1 Click the Windows **Start** button.
- 2 Type **cmd** in the Search field. The cmd window appears.
- 3 Type **ipconfig/renew** and press **Enter** to renew the IP address of the computer.

Renewing the IP Address on Windows XP Systems

- 1 Click **Start**, and then click **Run**. The Run window appears.
- 2 Type **cmd** in the Open field and click **OK**. A window with a command prompt appears.
- 3 Type **ipconfig/release** at the C:/ prompt and press **Enter**. The system releases the IP address.
- 4 Type **ipconfig/renew** at the C:/ prompt and press **Enter**. The system displays a new IP address.

- 5 Click the **X** in the upper-right corner of the window to close the Command Prompt window. You have completed this procedure.

Note: If you cannot access the Internet, contact your service provider for further assistance.

Renewing the IP Address on Macintosh Systems

- 1 Close all open programs.
- 2 Open your **Preferences** folder.
- 3 Drag the **tcp/ip preferences** file to the Trash.
- 4 Close all open windows and empty the Trash.
- 5 Restart your computer.
- 6 As your computer starts, simultaneously press and hold down the **Command (Apple)**, **Option, P**, and **R** keys on your keyboard. Keeping those keys pressed down, power on your Macintosh but do not release these keys until you hear the Apple chime at least three times, release the keys and let the computer restart.
- 7 When your computer fully reboots, click the **Apple** icon in the upper-left corner of the Finder. Scroll down to **Control Panels**, and then click **TCP/IP**.
- 8 Click **Edit** on the Finder at the top of the screen. Scroll down to the bottom of the menu, and then click **User Mode**.
- 9 Click **Advanced** in the User Mode window, and then click **OK**.
- 10 Click the Up/Down selector arrows located to the right of the Connect Via section of the TCP/IP window, and then click **Using DHCP Server**.
- 11 Click **Options** in the TCP/IP window, and then click **Active** in the TCP/IP Options window.

Note: In some cases, the **Load only when needed** option does not appear. If it appears, select the option. A check mark appears in the option.
- 12 Verify that the **Use 802.3** option located in the upper-right corner of the TCP/IP window is not selected. If there is a check mark in the option, select the option to clear the check mark, and then click **Info** in the lower-left corner.
- 13 Is there a Hardware Address listed in this window?
 - If **yes**, click **OK**. To close the TCP/IP Control Panel window, click **File**, and then scroll down to click **Close**.
 - If **no**, repeat these instructions from Step 6.
- 14 Reboot your computer.

What if I Do Not Subscribe to Cable TV?

If cable TV is available in your area, data service may be made available with or without subscribing to cable TV service. Contact your local service provider for complete information on cable services, including high-speed Internet access.

How Do I Arrange for Installation?

Call your service provider to inquire about professional installation. A professional installation ensures proper cable connection to the residential gateway and to your PC, and it ensures the proper configuration of all hardware and software settings. Contact your service provider for more information about installation.

How Does the Wireless Residential Gateway Connect to My Computer?

The residential gateway connects to the 10/100/1000BASE-T Ethernet port on your PC. To use the Ethernet interface, your PC needs Ethernet cards. These cards are available from your local PC or office supply retailer, or from your service provider. For best performance over an Ethernet connection, your PC should be equipped with a Gigabit Ethernet card.

After My Wireless Residential Gateway Is Connected, How Do I Access the Internet?

Your local service provider becomes your Internet service provider (ISP). They offer a wide range of services including email, chat, news, and information services. Your service provider will provide the software that you will need.

Can I Watch TV and Surf the Internet at the Same Time?

Absolutely! If you subscribe to cable television service, you can watch TV and use your residential gateway at the same time by connecting your TV and your residential gateway to the cable network using an optional cable signal splitter.

Common Troubleshooting Issues

This section describes common problems and offers solutions.

I don't understand the front panel status indicators

See *Operation of Front Panel Indicators* (on page 21), for more detailed information on front panel LED status indicator operation and function.

The Wireless Residential Gateway does not register an Ethernet connection

Try one of the following solutions:

- Verify that your computer has an Ethernet card and that the Ethernet driver software is properly installed. If you purchase and install an Ethernet card, follow the installation instructions very carefully.
- Verify the status of the front panel status indicator lights.

The Wireless Residential Gateway does not register an Ethernet connection after connecting to a hub

If you are connecting multiple PCs to the residential gateway, you should first connect the residential gateway to the uplink port of the hub using the correct crossover cable. The LINK LED of the hub will illuminate continuously.

The Wireless Residential Gateway does not register a cable connection

The residential gateway works with a standard, 75-ohm, RF coaxial cable. If you are using a different cable, your residential gateway will not function properly. Contact your service provider to determine whether you are using the correct cable.

Tips for Improved Performance

If your residential gateway does not perform as expected, the following tips may help. If you need further assistance, contact your service provider.

- Verify that the plug to your residential gateway AC power is properly inserted into an electrical outlet.
- Verify that your residential gateway AC power cord is not plugged into an electrical outlet that is controlled by a wall switch. If a wall switch controls the electrical outlet, make sure the switch is in the **ON** position.
- Verify that the **ONLINE** LED status indicator on the front panel of your residential gateway is illuminated.
- Verify that your cable service is active and that it supports two-way service.
- Verify that all cables are properly connected, and that you are using the correct cables.
- If you are using the Ethernet connection, verify that your TCP/IP is properly installed and configured.
- Verify that you have called your service provider and given them the serial number and MAC address of your residential gateway.
- If you are using a cable signal splitter so that you can connect the residential gateway to other devices, remove the splitter and reconnect the cables so that the residential gateway is connected directly to the cable input. If the residential gateway now functions properly, the cable signal splitter may be defective and may need to be replaced.
- If you are connected to your PC with an Ethernet connection, your PC should be equipped with a Gigabit Ethernet card for best performance.

5

Customer Information

Introduction

If you have technical questions, call Cisco Services for assistance. Follow the menu options to speak with a service engineer.

Access your company's extranet site to view or order additional technical publications. For accessing instructions, contact the representative who handles your account. Check your extranet site often as the information is updated frequently.



Americas Headquarters

Cisco Systems, Inc.
170 West Tasman Drive
San Jose, CA 95134-1706
USA

<http://www.cisco.com>
Tel: +1-408 526-4000
+1-800 553-6387
Fax: +1-408 527-0883

This document includes various trademarks of Cisco Systems, Inc. Please see the Notices section of this document for a list of the Cisco Systems, Inc. trademarks used in this document.

Product and service availability are subject to change without notice.

© 2014 Cisco and/or its affiliates. All rights reserved.

November 2014

Part Number OL-30544-01