



User Manual

AC5300 Ultra Wi-Fi Router

DIR-895L

Preface

D-Link reserves the right to revise this publication and to make changes in the content hereof without obligation to notify any person or organization of such revisions or changes.

Manual Revisions

Revision	Date	Description
1.00	January 12, 2016	Initial release

Trademarks

D-Link and the D-Link logo are trademarks or registered trademarks of D-Link Corporation or its subsidiaries in the United States or other countries. All other company or product names mentioned herein are trademarks or registered trademarks of their respective companies.

Apple®, Apple logo®, Safari®, iPhone®, iPad®, iPod touch® and Macintosh® are trademarks of Apple Inc., registered in the U.S. and other countries. App StoreSM is a service mark of Apple Inc.

Chrome™ browser, Google Play™ and Android™ are trademarks of Google Inc.

Internet Explorer®, Windows® and the Windows logo are trademarks of the Microsoft group of companies.

Copyright © 2016 by D-Link Corporation, Inc.

All rights reserved. This publication may not be reproduced, in whole or in part, without prior expressed written permission from D-Link Corporation, Inc.

Power Usage

This device is an Energy Related Product (ErP) with High Network Availability (HiNA), and automatically switches to a power-saving Network Standby mode within 1 minute of no packets being transmitted. It can also be turned off through a power switch to save energy when it is not needed.

Network Standby: 10.10 watts

Switched Off: 0.11 watts

Table of Contents

Preface	i	Pictures.....	32
Manual Revisions.....	i	Videos.....	34
Trademarks.....	i	Music.....	36
Power Usage.....	i	Folders.....	39
Product Overview	1	Favorites.....	42
Package Contents.....	1	Using the mydlink SharePort™ app for Android™ ...	43
System Requirements.....	2	Main Menu.....	48
Introduction.....	3	Documents.....	49
Features.....	4	Pictures.....	51
Antenna Setup.....	5	Videos.....	53
Hardware Overview.....	6	Music.....	55
Connections.....	6	Folders.....	58
LEDs.....	7	Favorites.....	62
Installation	8	Configuration	63
Before you Begin.....	8	Home.....	64
Wireless Installation Considerations.....	9	Internet.....	64
Manual Setup.....	10	DIR-895L.....	65
Getting Started	13	Connected Clients.....	66
Setup Wizard.....	14	USB Device.....	67
QRS Mobile App.....	19	Settings.....	68
mydlink SharePort.....	24	Wizard.....	68
Using the mydlink SharePort™ app for iPad®,		Internet.....	68
iPhone®, and iPod touch®.....	24	IPv6.....	77
Main Menu.....	29	Wireless.....	92
Documents.....	30	Guest Zone.....	94
		Network.....	95

SharePort	97	Windows® 7.....	121
Create User	98	WPA/WPA2	121
mydlink.....	99	WPS.....	124
Features.....	100	Windows Vista®	128
QoS Engine.....	100	WPA/WPA2	129
Firewall Settings.....	101	Windows® XP.....	131
IPv4/IPv6 Rules	103	WPA/WPA2	132
Port Forwarding	104	Troubleshooting	134
Virtual Server	105	Wireless Basics	138
Website Filter.....	106	What is Wireless?.....	139
Static Routes.....	107	Tips.....	141
IPv6	108	Wireless Modes.....	142
Dynamic DNS	109	Networking Basics	143
IPv6 Host	110	Check your IP address.....	143
Management.....	111	Windows® 8 Users.....	143
Time & Schedule	111	Windows® 7/Vista® Users.....	143
Time	111	Statically Assign an IP address	144
Schedule	112	Windows® 8 Users	144
System Log.....	113	Windows® 7/ Vista® Users	145
Admin	114	Technical Specifications	146
System	115	Contacting Technical Support	147
Upgrade	116	Warranty.....	148
Statistics	117	Registration	155
Connect a Wireless Client to your Router	118		
WPS Button.....	118		
Windows® 8.....	119		
WPA/WPA2	119		

Package Contents

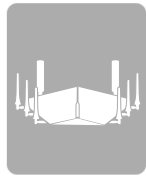

DIR-895L



Ethernet Cable

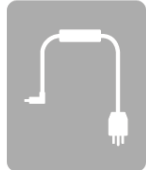

Power Adapter

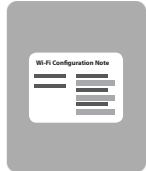

Wi-Fi Configuration Card



Quick Installation Guide



D-Link Cloud Service Mobile Apps Guide

If any of the above items are missing, please contact your reseller.

Note: Using a power supply with a different voltage rating than the one included with the DIR-895L will cause damage and void the warranty for this product.

System Requirements

Network Requirements	<ul style="list-style-type: none">• An Ethernet-based cable or DSL modem• 802.11ac/n/g/a wireless or Ethernet clients
Web-based Configuration Utility Requirements	<p>Computer with the following:</p> <ul style="list-style-type: none">• Windows®, Macintosh, or Linux-based operating system• An installed Ethernet adapter <p>Browser Requirements:</p> <ul style="list-style-type: none">• Internet Explorer 9 or higher• Firefox 20 or higher• Safari 5.1 or higher• Chrome 25 or higher <p>Windows® Users: Make sure you have the latest version of Java installed. Visit www.java.com to download the latest version.</p>
mydlink Requirements	<p>For mydlink and mydlink app requirements refer to: http://www.mydlink.com.</p>

Introduction

The D-Link DIR-895L AC5300 Ultra Wi-Fi Router uses advanced AC beamforming technology to maximize the speed and range of your wireless signal to significantly outperform 802.11n and other 802.11ac devices. It also comes equipped with four Gigabit ports to provide speeds up to 10x faster than standard 10/100 ports. With the addition of Advanced Quality of Service (QoS), data streams are separated, which helps organize and prioritize your network traffic so your video streaming, gaming, and VoIP calls run smoother over both your wired and wireless network.

The DIR-895L supports a host of cloud features including QRS Mobile, which allows you to setup and configure the router using a mobile app. You can set up your router right from your sofa, no PC required.

The AC5300 Ultra Wi-Fi Router is also mydlink-enabled, which gives you access to your home network no matter where you go. Now you can monitor and manage your home network right from your laptop, iPhone®, iPad®, or Android™ device. mydlink-enabled routers can be configured to send an email to keep you informed anywhere, anytime when new devices are connecting to your network or unwanted access is detected. Monitor in real-time websites that are being visited with recent browser history displayed on the mydlink™ Lite app – which is great for parents.

SharePort technology lets you take advantage of the USB 3.0 port found on the back of your DIR-895L (as well as an additional USB 2.0 port). Plug in a USB storage drive and you can use the mydlink SharePort™ app for iPad®, iPhone®, iPod touch®, and Android™ device to access files, stream videos, view photos, or listen to music on your laptop or mobile devices.

The DIR-895L AC5300 Ultra Wi-Fi Router provides incredible speeds, smart antenna technology, fast ports, cloud features, and terrific security features. It also features an innovative design and easy installation options.

Features

- **Faster Wireless Networking** - The DIR-895L introduces Smart Connect, a new D-Link feature which when combined with an additional 5 Ghz antenna can provide up to a full 5300 Mbps* wireless connection with concurrent 801.11ac and 802.11n wireless clients . It also operates on both the 2.4 GHz and 5 GHz bands to allow separation of traffic so users can participate in high-bandwidth activities, such as video streaming, online gaming, and real-time audio, without affecting low-priority traffic like email and web surfing.
- **Cloud Features** - The DIR-895L support the QRS Mobile app to setup the router using a mobile device. It is also mydlink-enabled so you can remotely access and manage your DIR-895L from a mobile device using the mydlink Lite app. The mydlink SharePort™ app can be used to share files, stream videos, view photos, and play music. SharePort Plus lets you share a printer.
- **Compatible with 802.11n/g/b/a Devices** - The DIR-895L is still fully compatible with the 802.11n, IEEE 802.11g, and 802.11a standards, so it can connect with existing 802.11n, 802.11g, 802.11b, and 802.11a wireless devices.
- **Advanced Firewall Features** - The web-based user interface displays a number of advanced network management features including:
 - **Content Filtering** - Easily applied content filtering based on MAC address, URL, and/or domain name.
 - **Scheduling** - The Firewall, wireless, and port forwarding features can be scheduled to be active on certain days, or for a duration of a set number of hours.
 - **Secure Multiple/Concurrent Sessions** - The DIR-895L can pass through VPN sessions. It supports multiple and concurrent IPSec and PPTP sessions, so users behind the DIR-895L can securely access corporate networks.
- **User-friendly Setup Wizard** - Through its easy-to-use web-based user interface, the DIR-895L lets you control what information is accessible to those on the wireless network, whether from the Internet, or from your company's server. Configure your router to your specific settings within minutes.

* Maximum wireless signal rate derived from IEEE Standard 802.11a, 802.11b, 802.11g, 802.11n, and 802.11ac specifications. Actual data throughput will vary. Network conditions and environmental factors, including volume of network traffic, building materials and construction, and network overhead, lower actual data throughput rate. Environmental conditions will adversely affect wireless signal range.

Antenna Setup

The DIR-895L is designed to give you the fastest, most stable network connection possible. In order to maximize performance, orient the antennas at an angle, pointing outward and away from the base unit.

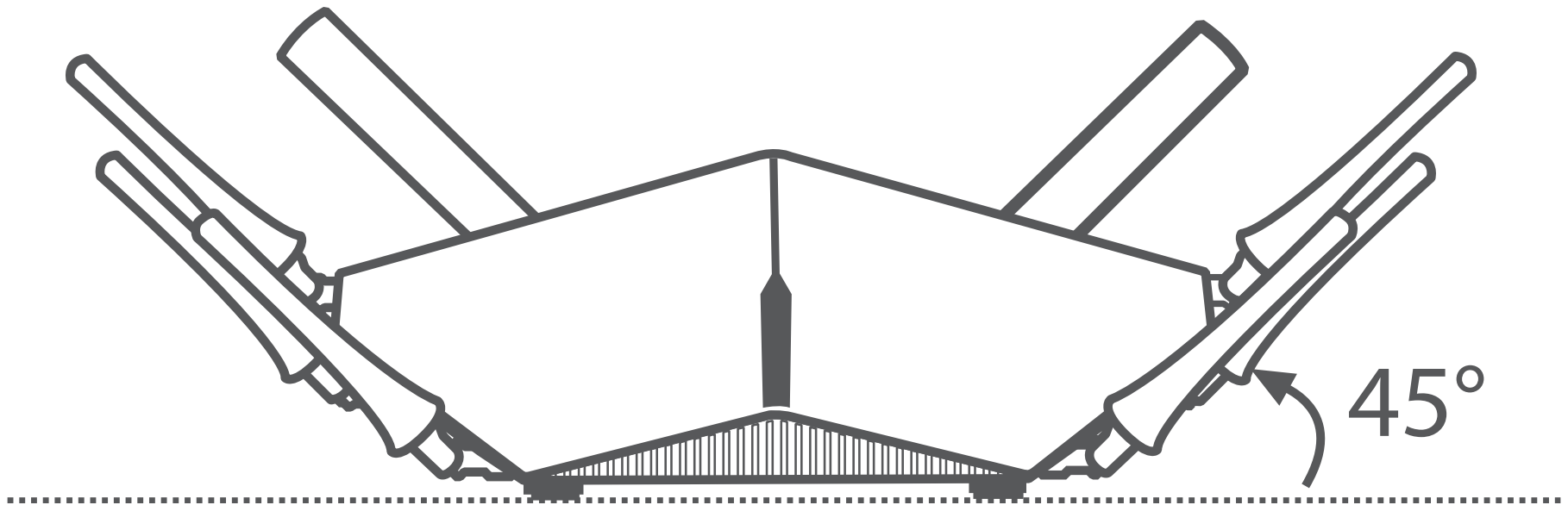

Note: Attach the antennas to the router before powering it on.

Hardware Overview

Connections

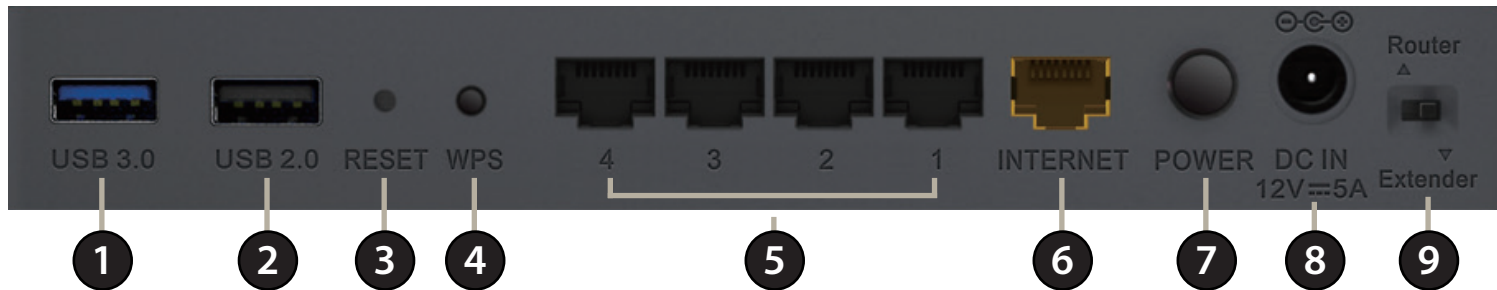

1	USB 3.0 Port	Connect a USB flash drive to share content, or connect it to a USB printer to share it on your network.
2	USB 2.0 Port	Connect a USB flash drive to share content, or connect it to a USB printer to share it on your network.
3	Reset Button	Insert a paperclip in the hole and wait for several seconds to reset the router to default settings.
4	WPS Button	Press to start the WPS process and automatically create a secure connection to a WPS client.
5	Gigabit LAN Ports (1-4)	Connect Ethernet devices such as computers, switches, storage (NAS) devices and game consoles.
6	Gigabit Internet Port	Using an Ethernet cable, connect your broadband modem to this port.
7	Power Button	Press the power button to power the router on and off.
8	Power Connector	Connector for the supplied power adapter.
9	Mode	Select between Router and Extender modes. To change modes, move the switch to the desired position and after five seconds the router will reboot into the desired mode. Router is the default mode.

Hardware Overview

LEDs

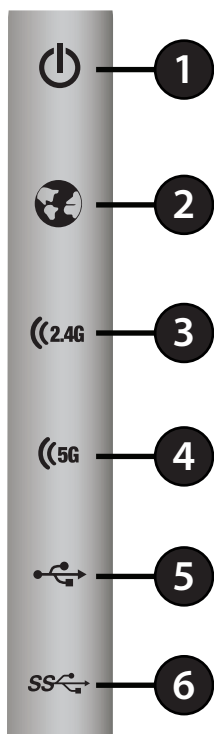

1	Power LED	A solid white light indicates a proper connection to the power supply. The light will be solid orange during boot-up.
2	Internet LED	A solid white light indicates a connection to the Internet port. If the LED is orange, the connection is good but the router cannot connect to the Internet.
3	2.4GHz Wireless LED	A solid light indicates the 2.4GHz wireless function is working properly. During the WPS process, this light will blink.
4	5GHz Wireless LED	A solid light indicates the 5GHz wireless function is working properly. During the WPS process, this light will blink.
5	USB 2.0	A solid light indicates a USB 2.0 device is connected.
6	USB 3.0	A solid light indicates a USB 3.0 device is connected.

Installation

This section will walk you through the installation process. Placement of the router is very important. Do not place the router in an enclosed area such as a closet, cabinet, or in the attic or garage.

Before you Begin

- Please configure the router with the computer that was last connected directly to your modem.
- You can only use the Ethernet port on your modem. If you were using the USB connection before using the router, then you must turn off your modem, disconnect the USB cable and connect an Ethernet cable to the Internet port on the router, and then turn the modem back on. In some cases, you may need to call your ISP to change connection types (USB to Ethernet).
- If you have DSL and are connecting via PPPoE, make sure you disable or uninstall any PPPoE software such as WinPoET, BroadJump, or EnterNet 300 from your computer or you will not be able to connect to the Internet.

Wireless Installation Considerations

The D-Link wireless router lets you access your network using a wireless connection from virtually anywhere within the operating range of your wireless network. Keep in mind that the number, thickness and location of walls, ceilings, or other objects that the wireless signals must pass through may limit the range. Typical ranges vary depending on the types of materials and background RF (radio frequency) noise in your home or business. The key to maximizing wireless range is to follow these basic guidelines:

1. Keep the number of walls and ceilings between the D-Link router and other network devices to a minimum - each wall or ceiling can reduce your adapter's range from 3-90 feet (1-30 meters.) Position your devices so that the number of walls or ceilings is minimized.
2. Be aware of the direct line between network devices. A wall that is 1.5 feet thick (0.5 meters), at a 45-degree angle appears to be almost 3 feet (1 meter) thick. At a 2-degree angle it looks over 42 feet (14 meters) thick! Position devices so that the signal will travel straight through a wall or ceiling (instead of at an angle) for better reception.
3. Building materials make a difference. A solid metal door or aluminum studs may have a negative effect on range. Try to position access points, wireless routers, and computers so that the signal passes through drywall or open doorways. Materials and objects such as glass, steel, metal, walls with insulation, water (fish tanks), mirrors, file cabinets, brick, and concrete will degrade your wireless signal.
4. Keep your product away (at least 3-6 feet or 1-2 meters) from electrical devices or appliances that generate RF noise.
5. If you are using 2.4 GHz cordless phones or X-10 (wireless products such as ceiling fans, lights, and home security systems), your wireless connection may degrade dramatically or drop completely. Make sure your 2.4 GHz phone base is as far away from your wireless devices as possible. The base transmits a signal even if the phone is not in use.

Manual Setup

1. Attach the eight antennas to the router by twisting them on clockwise.

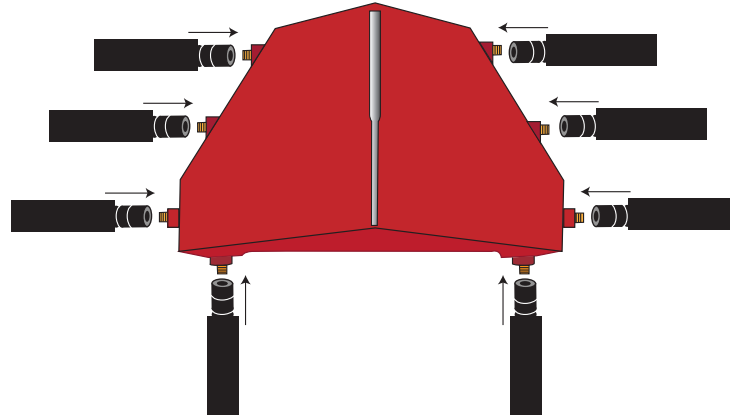

2. Unplug the power to your DSL or Cable modem.

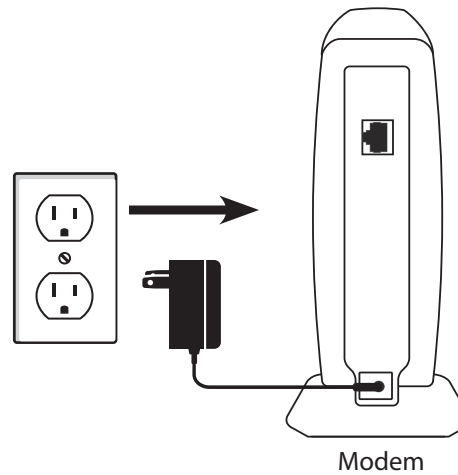

3. Unplug the power to your DSL or Cable modem. Connect an Ethernet cable from the Internet port of the router to the Ethernet port on your DSL or Cable modem.

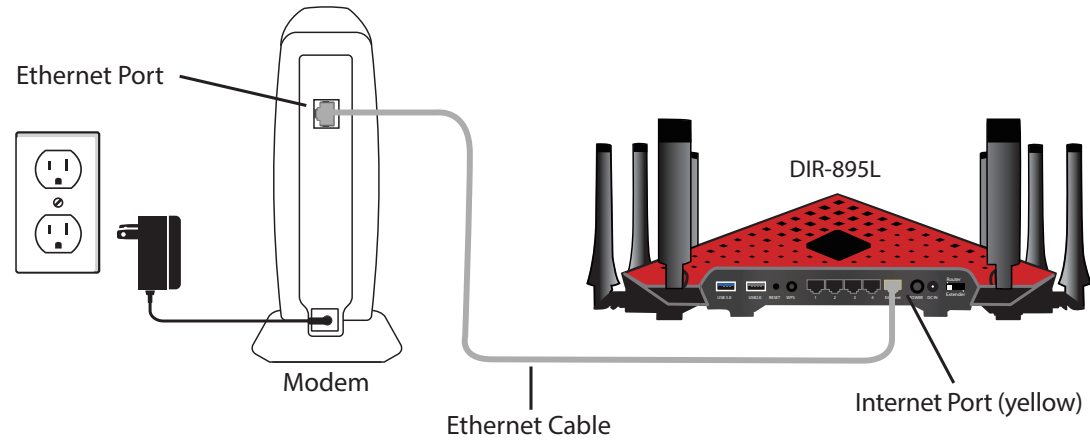

4. Connect another Ethernet cable from the Ethernet port on your computer to one of the LAN ports on the router. You can also connect wirelessly to the router with your computer. Use the supplied Wi-Fi Configuration Card for the Wi-Fi network name (SSID) and Wi-Fi password of the router. Complete steps 5 and 6 before attempting to connect.

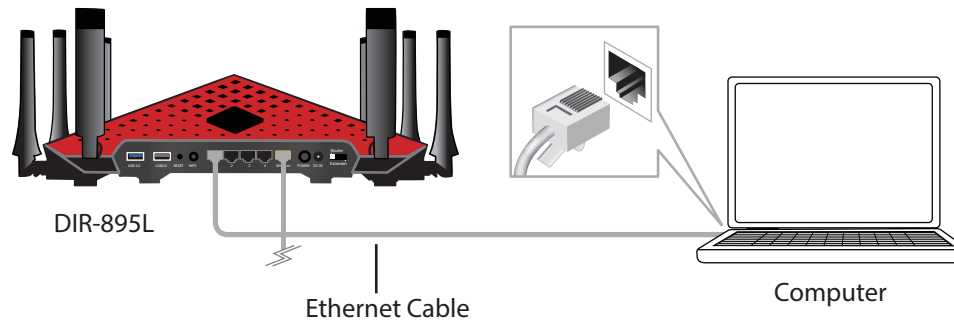

5. Plug the power back into your DSL or cable modem. Please wait about one minute before continuing.

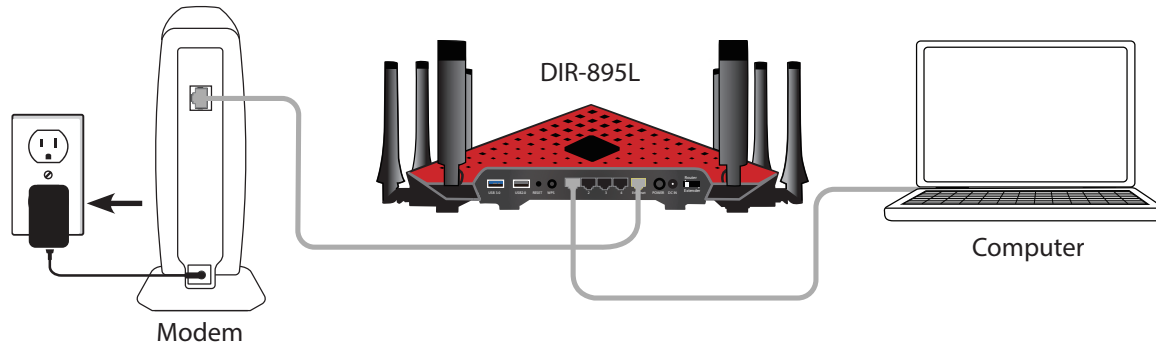

6. Plug the power adapter into your router and connect to an available power outlet or surge protector. If the Power LED does not light up, press the Power button on the back of the router.

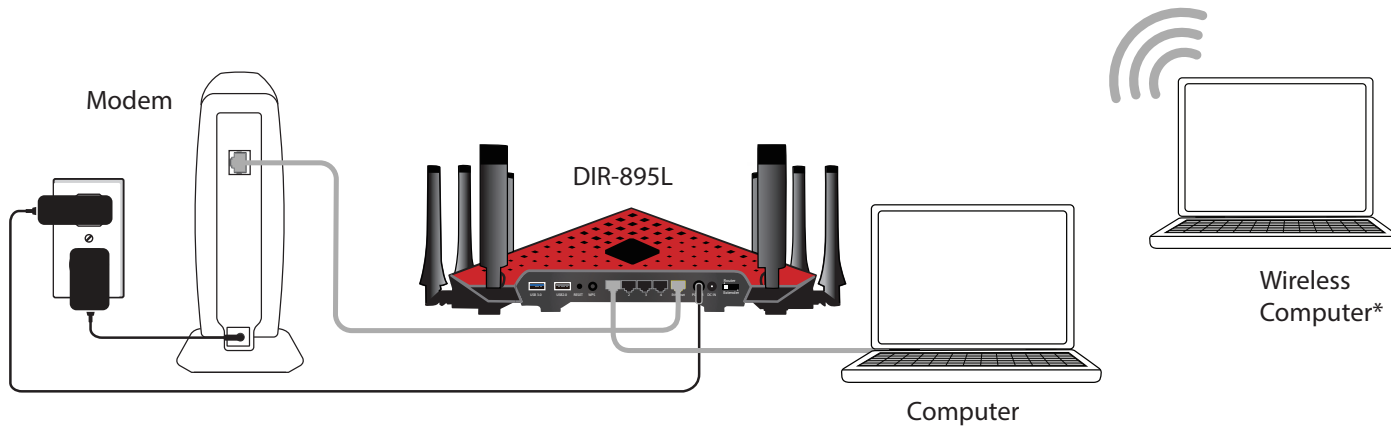

* If you are connecting wirelessly, you may now connect to the router using the supplied Wi-Fi Configuration Card for the Wi-Fi network name (SSID) and Wi-Fi password.

7. After the router has powered up, verify that the Power (white) and Internet (orange or white) LEDs are both lit. Proceed with router configuration.

Getting Started

There are several different ways you can configure your router to connect to the Internet and connect to your clients:

- **D-Link Setup Wizard** - This wizard will launch when you log into the router for the first time. Refer to page 14.
- **QRS Mobile App** - Use your iPhone, iPad, or iPod touch to configure your router. Refer to page 19.
- **Manual Setup** - Log into the router and manually configure your router. Refer to page 63

Setup Wizard

If this is your first time installing the router, open your web browser and enter **http://dlinkrouter.local/** in the address bar. Alternatively, enter the IP address of the router (default: **http://192.168.0.1**). Please refer to page 63.

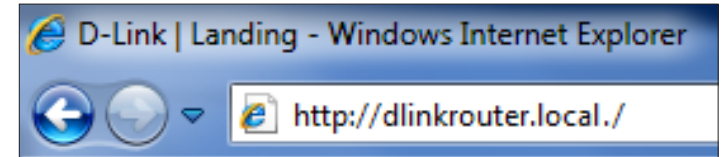

The wizard is designed to guide you through a step-by-step process to configure your new D-Link router and connect to the Internet.

Click **Next** to continue.

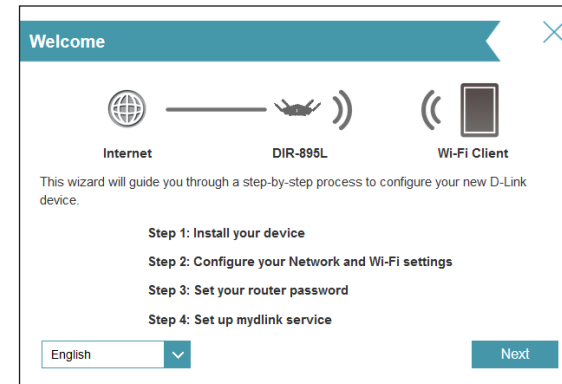

Please wait while your router detects your Internet connection type. If the router detects your Internet connection, you may need to enter your ISP information such as username and password.

If the router does not detect a valid Internet connection, a list of connection types to choose from will be displayed.

Select your Internet connection type (this information can be obtained from your Internet service provider) and click **Next** to continue.

If the router detected or you selected **PPPoE**, enter your PPPoE username and password and click **Next** to continue.

Note: Make sure to remove your PPPoE software from your computer. The software is no longer needed and will not work through a router.

If the router detected or you selected **Static**, enter the IP and DNS settings supplied by your ISP. Click **Next** to continue.

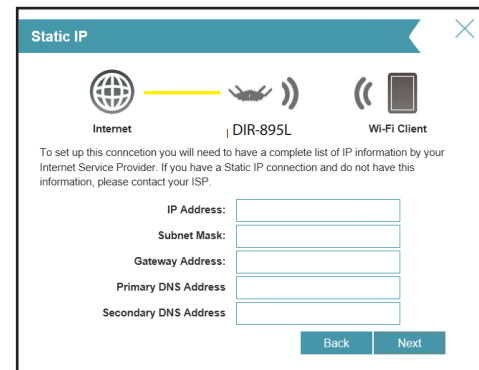
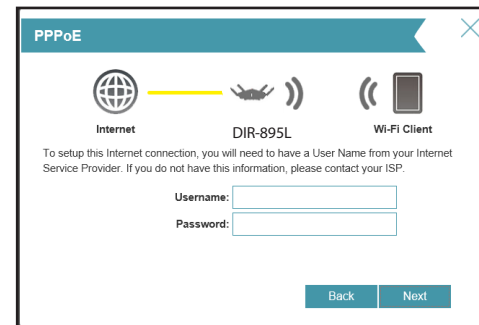
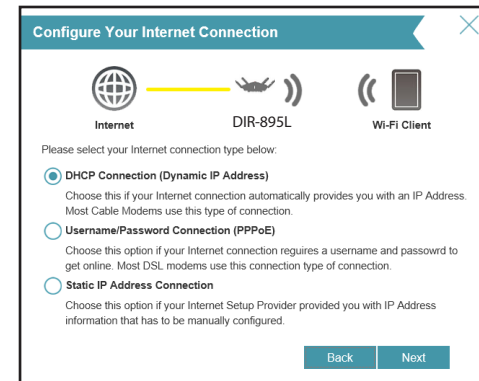

Create a Wi-Fi password (between 8-63 characters). Your wireless clients will need to have this passphrase or key entered to be able to connect to your wireless network.

Click **Next** to continue.

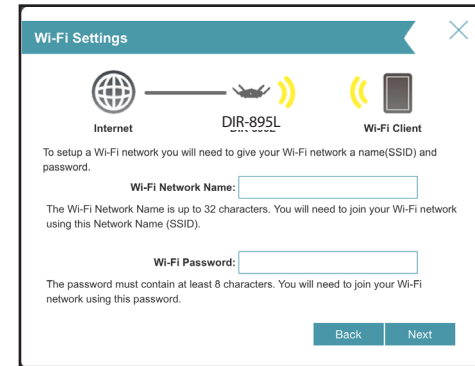

In order to secure the router, please enter a new password. You will be prompted for this password every time you want to use the router's web configuration utility. Click **Next** to continue.

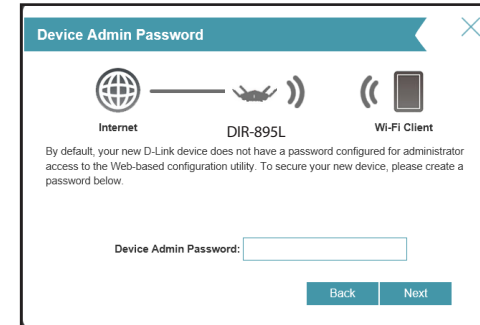

The Summary window will display your settings. Click **Next** if you are satisfied, or click **Back** to make changes to them.

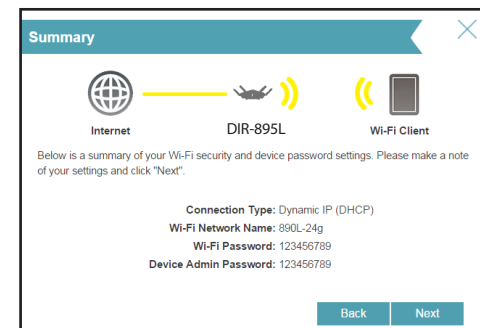

To use the mydlink service (mydlink.com or the mydlink Lite app), you must have an account. Select **Yes** if you have a mydlink account already, or **No** if you want to create one. Click **Next** to continue.

If you do not want to register at this time, click **Skip**.

If you clicked **Yes**, enter your mydlink account name (email address) and password. Click **Next** to register your mydlink account with the router.

If you clicked **No**, fill out the requested information and click **Next** to create your mydlink account.

At the end of the wizard, you will be presented with a final summary of your settings. Click **Finish** to close the wizard.

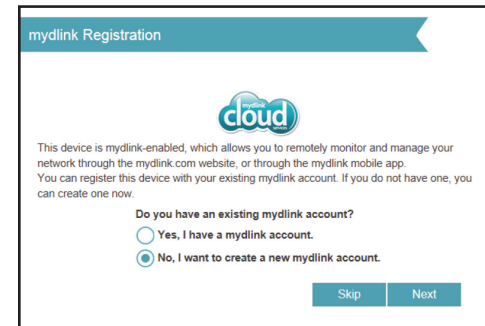

mydlink Registration



This device is mydlink-enabled, which allows you to remotely monitor and manage your network through the mydlink.com website, or through the mydlink mobile app. You can register this device with your existing mydlink account. If you do not have one, you can create one now.

Do you have an existing mydlink account?

Yes, I have a mydlink account.

No, I want to create a new mydlink account.

Skip Next

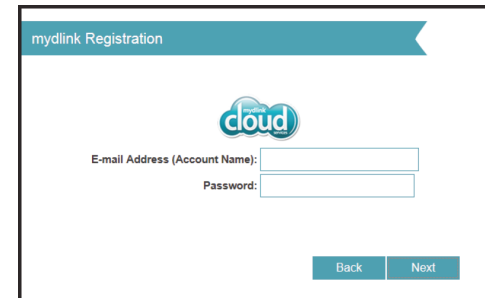

mydlink Registration



E-mail Address (Account Name):

Password:

Back Next

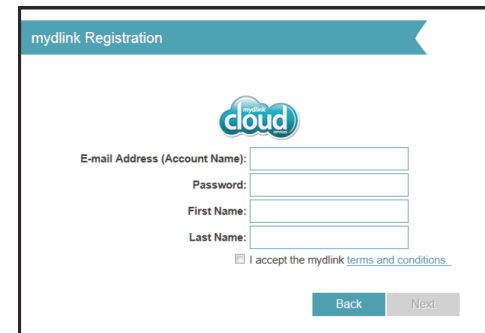

mydlink Registration



E-mail Address (Account Name):

Password:

First Name:

Last Name:



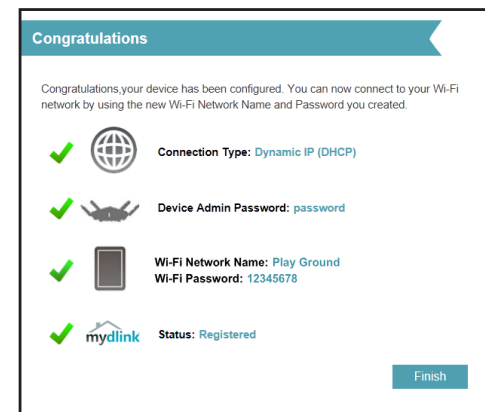

I accept the mydlink [terms and conditions](#).

Back Next



Congratulations

Congratulations, your device has been configured. You can now connect to your Wi-Fi network by using the new Wi-Fi Network Name and Password you created.

-  **Connection Type:** Dynamic IP (DHCP)
-  **Device Admin Password:** password
-  **Wi-Fi Network Name:** Play Ground
Wi-Fi Password: 12345678
-  **Status:** Registered

Finish

The mydlink App will allow you to receive notices, browse network users, and configure your router from an iPhone/iPad/iPod touch (iOS 6.0 or higher), or Android device (2.3 or higher).

To download the "mydlink Lite" app, visit the Apple Store, Android Market or <http://mydlink.com/Lite>.



PC and Mac users can use the mydlink portal at <http://mydlink.com>.

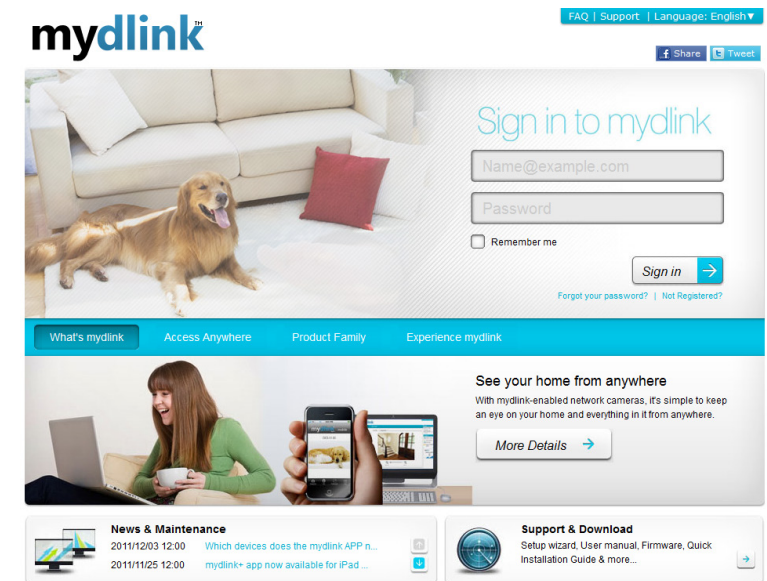

QRS Mobile App

QRS Mobile app allows you to install and configure your router from your mobile device.

Step 1

Search for the free **QRS Mobile** App on the iTunes Store or Google Play.

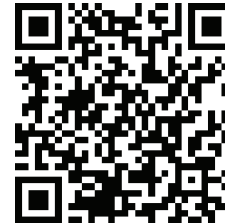

Step 2

Once your app is installed, you may now configure your router. Connect to the router wirelessly by going to your wireless utility on your device. Scan for the Wi-Fi name (SSID) as listed on the supplied info card. Select and then enter your Wi-Fi password.

D-Link Wi-Fi Configuration Card	
Default Configuration	Wi-Fi Name(SSID) 2.4GHz:
Wi-Fi Name (SSID): dlink-a8fa	Wi-Fi Password:
Wi-Fi Password: akbdj19368	Wi-Fi Name(SSID) 5GHz *:
	Wi-Fi Password *:
To configure your router, go to: http://dlinkrouter.local Or http://192.168.0.1 Username: "Admin" Password: * (leave the field blank)	Your configuration Username: "Admin" Password: *For applicable models

Step 3

Once you connect to the router, launch the QRS Mobile app from the Home screen of your device.

Note: The following steps show the Android interface of the QRS Mobile app. If you are using an iPhone, iPad, or iPod touch, the appearance may be different to that of the screenshots, but the process is the same.



Step 4

When the Welcome screen appears, tap **Start** to proceed, then enter your device password and tap **Log In**. Tap **Next** once the Operation Mode screen appears.

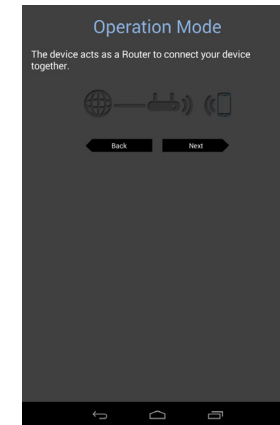
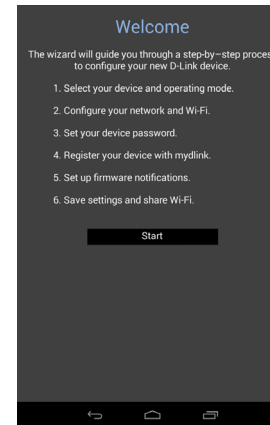

Step 5

At this point, please ensure that you the router is connected to a modem. Plug one end of the provided Ethernet cable into your DSL or cable modem, and plug the other end into the port marked INTERNET on the DIR-860L. Tap **Next** to automatically detect your Internet connection and proceed to the next step.

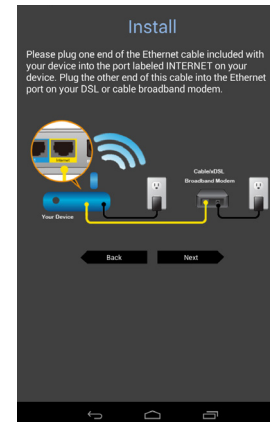

Step 6

Firstly, enter a network name (SSID) of your choice, or leave it unchanged to accept the default SSID.

Secondly, choose a Wi-Fi password of at least 8 characters. Any device trying to connect to the router wirelessly will need to enter this password the first time it connects.

Tap **Next** to continue.

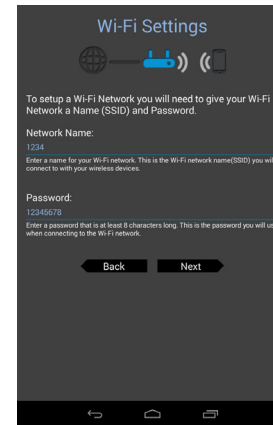

Step 7

Enter the administrator password of your choice. Unlike the Wi-Fi password, this password is only required when you need to configure the router. See "**Configuration**" on page 63 for details of when this password is used. Tap **Next** to continue.

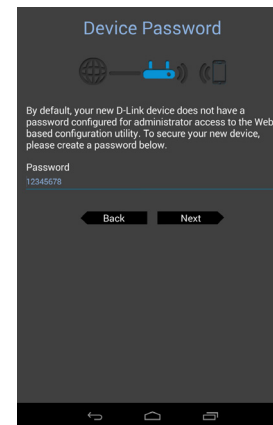

Step 8

If you already have a mydlink account, select **Yes, I have a mydlink account** and enter your mydlink email address and password. Lastly, tap **Sign In** to set up the router to use your mydlink account.

If you do not have a mydlink account, select **No, I want to create a new mydlink account**. Enter your E-mail address, choose a mydlink password and check the **I accept the mydlink terms and conditions** box. Finally, tap **Register account** to create your new mydlink account.

If you do not want to configure your router with mydlink at this stage, tap **Skip** to proceed.

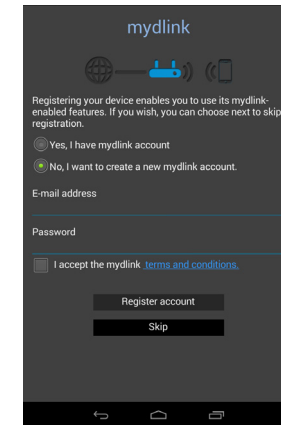
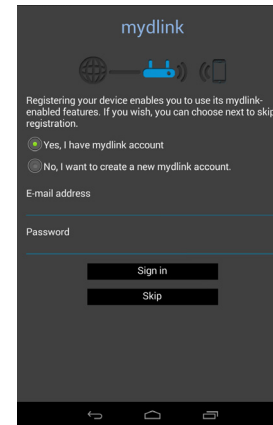

Step 9

If you wish to receive push notifications whenever a new firmware update is available, check the **Notify me when new firmware is available** box and tap **Next**.

Otherwise, just tap **Next** to proceed.

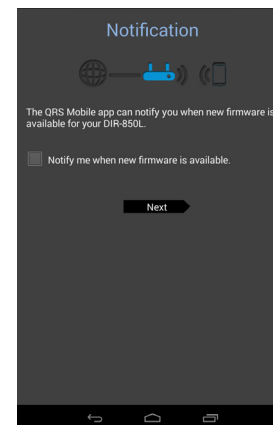

Step 10

Review your settings and then tap **Save** to complete the setup.

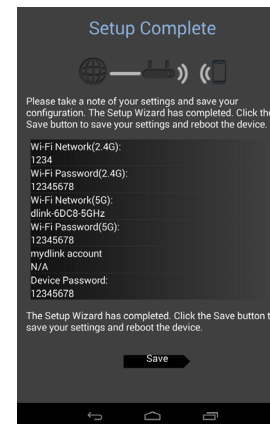

Congratulations, your device has been successfully configured! You can share this information by tapping **Share By NFC**, **Share By E-mail**, or tap **Finish** to exit the app.

If you tap **Share By NFC**, you can now touch the tag with your other device until the confirmation message appears.

Note: *NFC is not supported by iPhone, iPad, and iPod touch devices.*

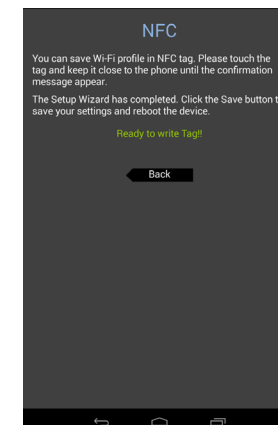
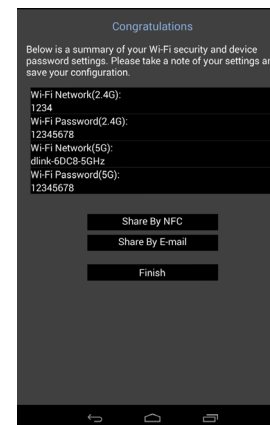

mydlink SharePort

Using the mydlink SharePort™ app for iPad®, iPhone®, and iPod touch®

The mydlink SharePort™ app is a streamlined mobile application that allows you to conveniently stream media and share files stored on a removable storage device connected to your router. Once the router is set up, you can start the app and easily connect from a local network or through the Internet to access your photos, videos, music, and documents. It allows you to create your own personal cloud storage. You can upload files and photos from your mobile device to the removable storage via the app from anywhere in the world!

Note: In order to ensure smooth streaming performance, you will need a minimum of 2 Mbit/s upload bandwidth for your router's Internet connection. Streaming performance will vary depending on the quality of your Internet connection.

Note: If you choose to skip the mydlink SharePort registration during the initial setup of your DIR-895L, you may begin the registration process anytime by accessing the mydlink SharePort feature from within the router configuration menu. Please see page 94 for details on how to begin the mydlink shareport registration process.

1. If you are connecting remotely through the mydlink SharePort™ app from the Internet, you will need a **mydlink** account.
2. Make sure the device is powered on. Then plug your USB drive into a USB port on the device.

Note: If you connect a removable storage device with several thousand files, it may take a while for the router to scan and catalog them.

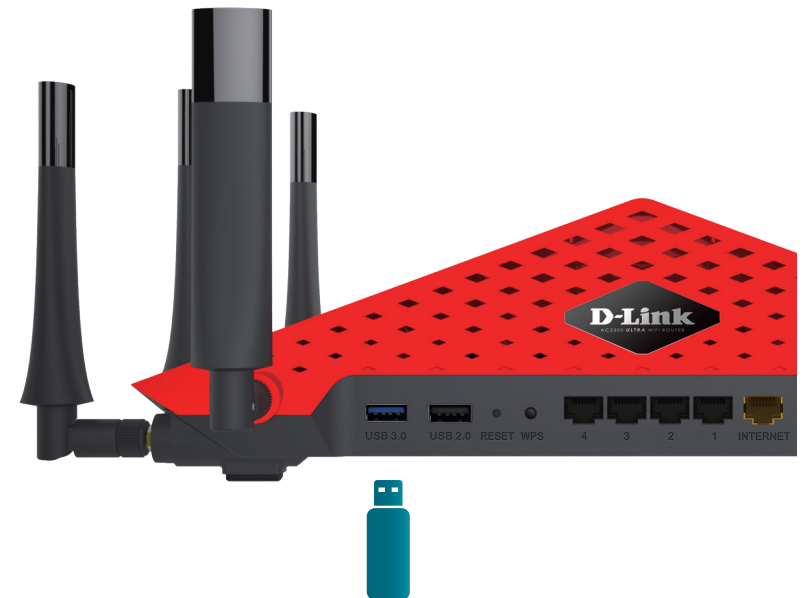

Plug your removable storage device in either the USB 2.0 or 3.0 port.

3. Use your iPhone, iPad or iPod touch to search for and download the free **mydlink SharePort** app from the App Store.

If you have a QR code reader, you can scan the code for **mydlink SharePort** to the right.



4. Tap the **mydlink SharePort** icon, and the app will load.



5. Tap **Set up** to go to Settings and enter the Admin password and your mydlink Account Login information when the pop-up displays. Tap **Done** when your information is entered. (The Admin password is only for local access, if you can connect through the Internet, then you can leave the Admin password blank)

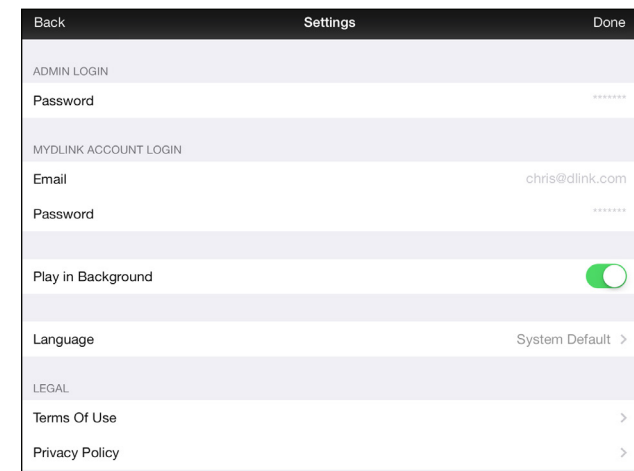
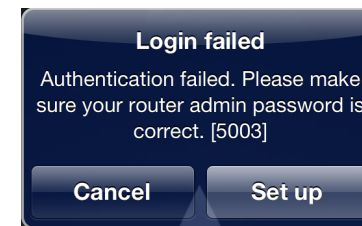

1. You can now use the mydlink SharePort app interface to stream media and access files stored on your removable drive. The wireless icon at the bottom will be lit green to indicate you are connected to the router through Remote Access. If you need to change your settings, tap the gear icon at the top right corner to enter the settings page.

2. If you have more than one device registered to your mydlink account, you can tap **Device List** (in the top-left corner) and you will be prompted to select the device you wish to use.

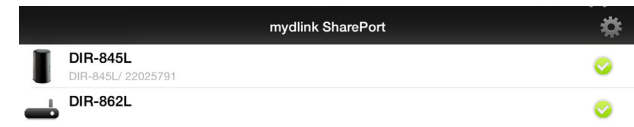

Note: A red wireless icon indicates that your router's network environment may not be optimal for streaming media and you may experience slow downs or otherwise degraded performance.

Using mydlink SharePort in a local network:

1. Make sure the device is powered on. Then plug your USB drive into the USB port of the device.

Note: If you connect a removable storage with many files or a large capacity, it may take a while for the router to scan and catalog your files.

2. Use your iPhone, iPad or iPod touch to search for and download the free **mydlink SharePort** app from the App Store.

If you have a QR code reader, you can scan the code for **mydlink SharePort** to the right.

3. On your mobile device, go to your Wi-Fi settings and connect to your router's wireless network using the default Wi-Fi settings. Locate the Wi-Fi name (SSID) and password for your device as printed on the included Wi-Fi Configuration Card.

4. Tap the **mydlink SharePort** icon, and the app will load.



1. Tap **Set up** to enter the Admin password for your router when the pop-up displays.

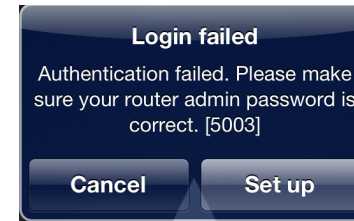

2. Enter your Admin Login in the Password field and tap **Done**.

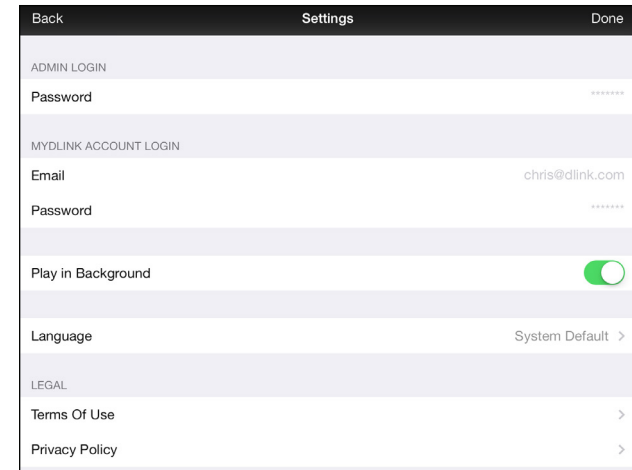

3. You can now use the mydlink SharePort app interface to stream media and access files stored on your removable drive. The wireless icon at the bottom will be lit blue to indicate a Local Access connection. If you need to change your settings, tap the gear icon at the top right corner to enter the settings page.



Note: A red wireless icon indicates that your router's network environment may not be optimal for streaming media and you may experience slow downs or otherwise degraded performance.

Main Menu

The mydlink SharePort main menu has different sections that let you see all the documents, photos, movies, or music stored on your removable storage. Tap < or >, or swipe left or right to move between the different sections. The Wi-Fi icon at the bottom indicates an active local network connection (blue) or remote connection (green/red). Tap **Log In** if it is not lit, or **Log Out** to return to the login page.



Tap on the document icon to view documents.



Tap the camera icon to view photos.



Tap on the movie icon to play videos.

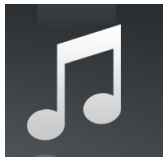

Tap on the music icon to play audio files.



Tap on the folder icon to browse all files in a folder view.

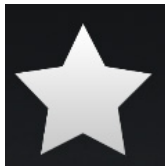

Tap on the star icon to access your favorite files.

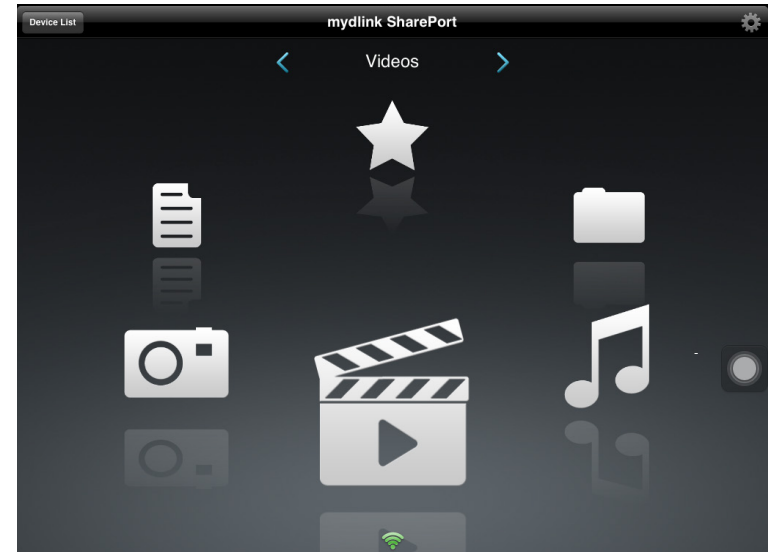

Documents

The Documents section allows you to share, print, and view documents streamed from your DIR-895L to your mobile device. Tap the document icon on the main menu to browse the documents on your mobile device.

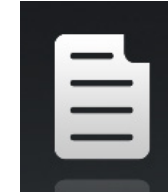

Search Bar: Enter a filename here to search your storage.



Tap to mark files for deletion.



Tap the star icon next to each file to download it to your device and add it into your Favorites section.



Tapping this icon gives you additional options:

- **Mail:** Tap to e-mail the file.
- **iCloud:** Tap to store the file on iCloud.
- **AirPrint:** Tap to print the file.
- **Open In...:** Tap to use a third-party app to open the file.

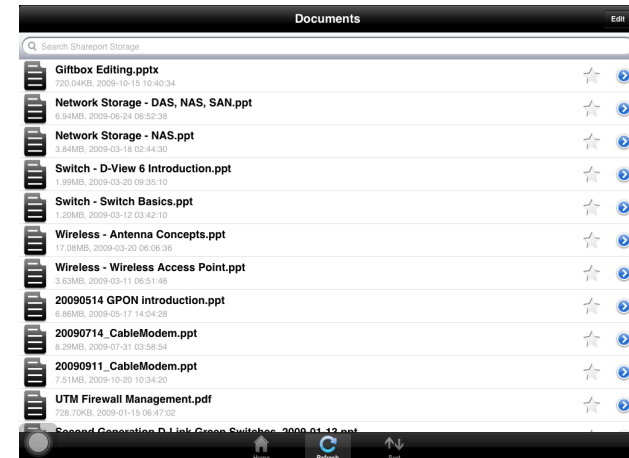

The bottom menu bar includes these options:



Tap to go back to the main menu.





Tap to update the list of files.



Tap to reorder the files alphabetically.

Tap on a file to start the document viewer. In the viewer:

 Tap to add/remove the file from your Favorites.

 Tap to bring up the same options as >.

Note: Some files may require a third-party app to view them.

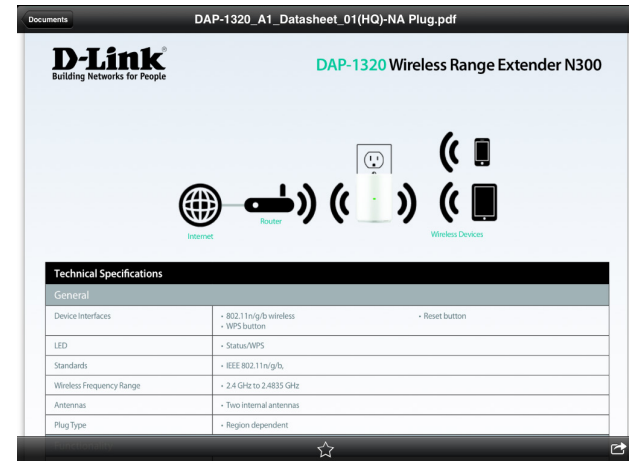

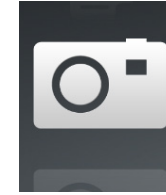

Pictures

The Pictures section allows you to stream images from your DIR-895L to your mobile device. Tap the camera icon on the main menu to browse your photo collection on your removable storage.



Search Bar: Enter a filename here to search your storage.

 Tap to mark files for deletion.

 Tap the star icon next to each file to download it to your device and add it into your Favorites section.

-  Tapping this icon gives you additional options:
- **Mail:** Tap to e-mail the image.
 - **iCloud:** Tap to store the image on iCloud.
 - **AirPrint:** Tap to print the image.
 - **Facebook:** Tap to upload the image to your Facebook account.
 - **Twitter:** Tap to upload the image to your Twitter account.
 - **Open In...:** Tap to use a third-party app to open the file.

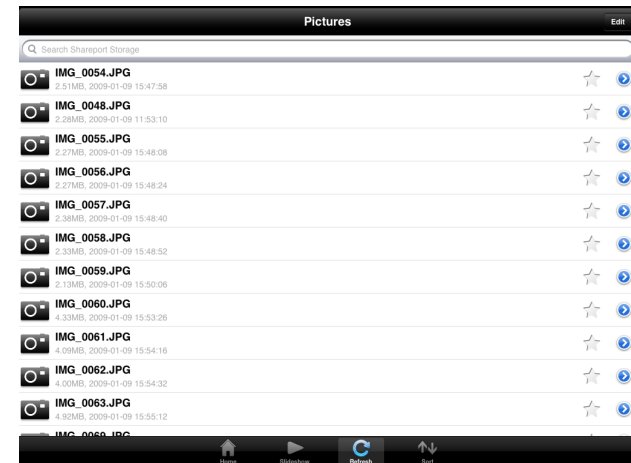

The bottom menu bar includes these options:



 Tap to go back to the main menu.

 Tap to start a slideshow of your photos. Tap the screen again to bring up the menu.

 Tap to update the list of files.

 Tap to reorder the files alphabetically.

Tap on a file to start the photo viewer. In the viewer:

-  Tap to add/remove the current image from your Favorites.
-  Tap to start the slideshow.
-  Tap to bring up the same options as >.

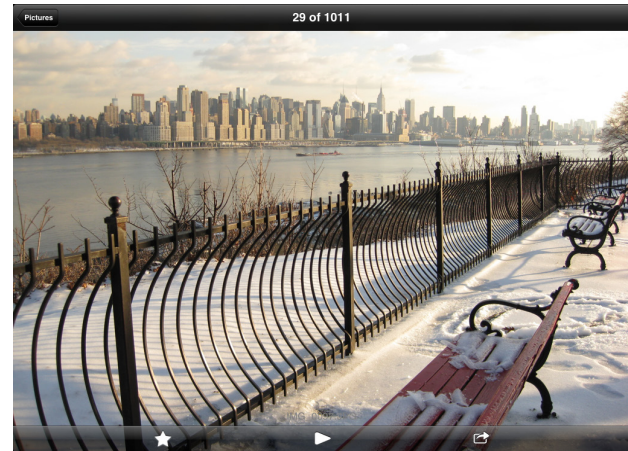



Videos

The Videos section allows you to stream video clips and movies from your DIR-895L to your mobile device. Tap the movie icon on the main menu to browse your videos on your removable storage.



Search Bar: Enter a filename here to search for a specific file.

 Tap to mark files for deletion.

 Tap the star icon next to a file to download it to your device and add it into your Favorites section.

 Tapping this icon gives you additional options:

- **Mail:** Lets you e-mail the file.
- **iCloud:** Lets you store the file on iCloud.
- **Open In...:** Lets you use a third-party app to open the file.

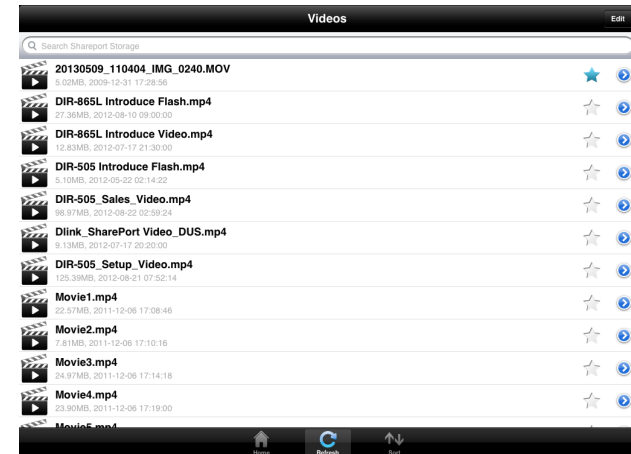





The bottom menu bar includes these options:

 Tap to go back to the main menu.

 Tap to update the list of files.

 Tap to reorder the files alphabetically.

Tap on a file to start playing it. In the player:

-  Tap to play/pause the video. You can scroll to any time on the time line by holding and sliding your finger.
-  Tap to enter/exit fullscreen mode.
-  Tap to add/remove the file from your Favorites.
-  Tapping this icon gives you additional options:
 - **Mail:** Lets you e-mail the video.
 - **iCloud:** Lets you store the video on iCloud.
 - **Open In...:** Lets you use a third-party app to open the file.



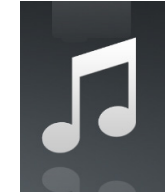

Music

The Music section allows you to stream songs from your DIR-895L to your mobile device. Tap the music icon on the main menu to browse your music collection on your removable storage.



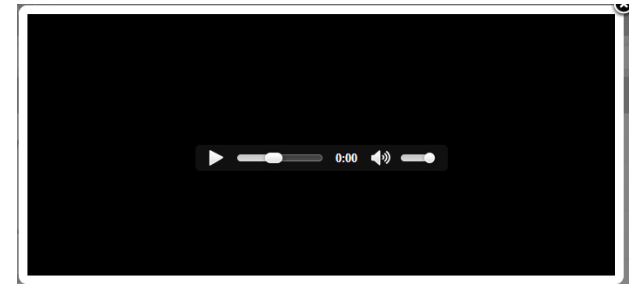

Search Bar: Enter a filename here to search your storage.

-  Tap to create a playlist and mark files for deletion.
-  Tap the star icon next to each file to download it to your device and add it into your Favorites section.
-  Tapping this icon gives you additional options:
 - **Mail:** Lets you e-mail the file.
 - **iCloud:** Lets you store the file on iCloud.
 - **Open In...:** Lets you use a third-party app to open the file.





The bottom menu bar includes these options:

-  Tap to go back to the main menu.
-  Tap to update the list of files.
-  Tap to reorder the files alphabetically.

Tap on a file to start playing it. In the player:

  Tap to repeat all. Tap again to repeat a single song.

  Tap to skip to the previous/next song.

 Tap to enable/disable shuffle mode.



To create a playlist:

Tap **Edit** > **Add Playlist**.

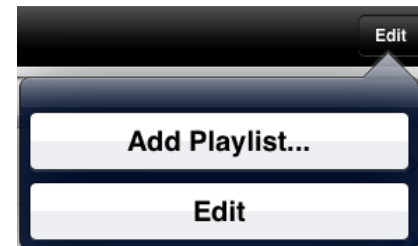

Enter a name for the playlist, then tap **Save**.

The name of the playlist will appear in the browser next to the  icon.

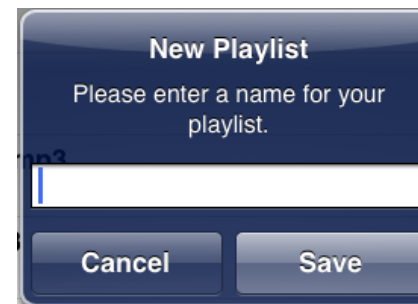

To add songs to a playlist:

Tap the playlist in the browser.

Tap **Add Music...** to add songs to the current playlist.

Tick the songs you wish to add and tap **Done**.

To delete songs from the playlist:

Tap **Edit** in the playlist browser and mark the files to be deleted.

Tap **Delete**.

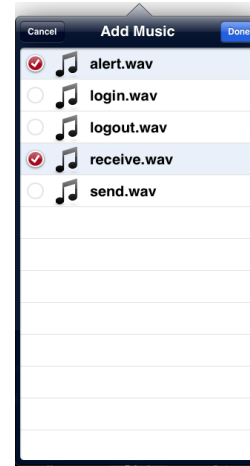



Folders

You can browse your removable storage in a folder view in the folders section. Tapping the filename will open the viewer/player for that file type as described in the previous pages. You can also upload files from your mobile device to the removable storage attached to your router.





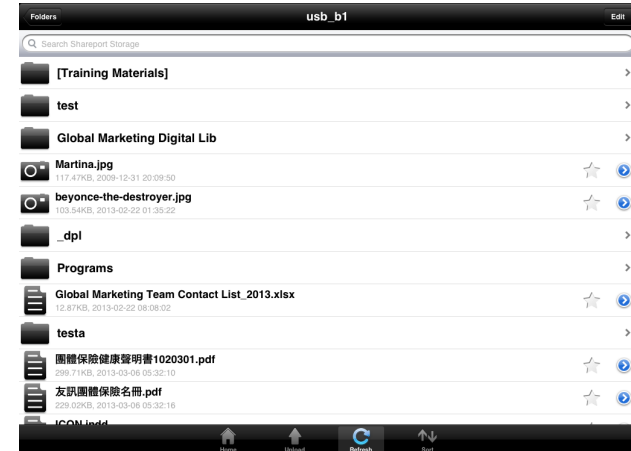

Search Bar: Enter a filename here to search your storage.

-  Tap to take you to the editing screen where you can add a folder and mark files for deletion or copying.
-  Tap the star icon next to each file to download it to your device and add it into your Favorites section.
-  Tapping the > icon gives you additional options depending on the file type.



The bottom menu bar includes these options:

-  Tap to go back to the main menu.
-  Tap to upload files from your device to your removable storage.
-  Tap to update the list of files.
-  Tap to reorder the files alphabetically.

To delete files:

- Tap **Edit** at the top right.
- Tick the circle next to a file to mark it for deletion.
- Tap on **Delete** at the bottom to delete the file.

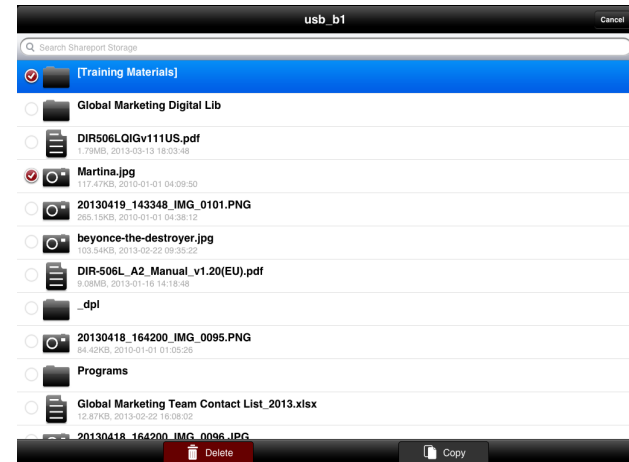

To copy files:

- Tap on **Copy** to bring up a window where you can select the folder to copy to.
- Browse to the directory you want to copy the marked files to and tap **Paste**.
- You can also tap **Add Folder** to create a new folder.

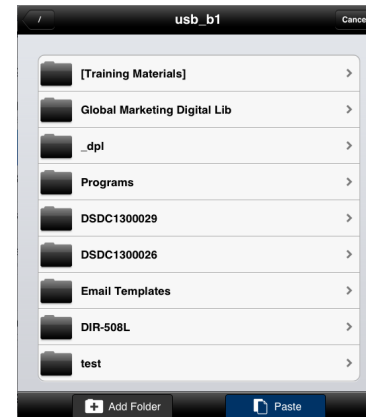

To create a new folder:

- Browse to the directory you wish to create a new folder in.
- Tap **Edit** at the top right.
- Tap **Add Folder** to add a new folder.
- Enter the name of the new folder, then tap **Save**.
- Tap **OK** to confirm folder creation.

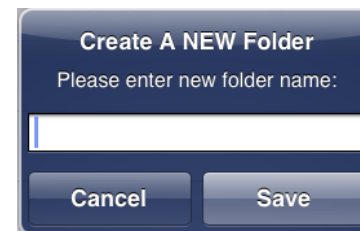

To upload images and videos from your mobile device:

Browse to the folder you wish to upload to.

Tap **Upload** at the bottom.

Select the photos/videos you wish to upload.

Tap **Done**.



During the upload process, the size of the file and the upload progress will be displayed.

To upload more files, tap the + icon at the top right and repeat the steps listed above.

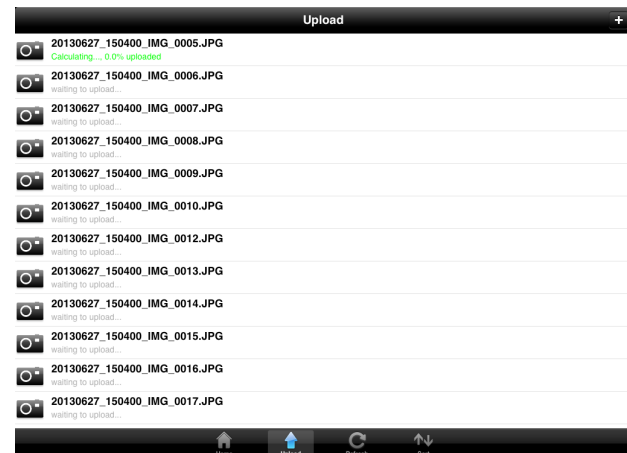

Favorites

The Favorites section allows you to quickly access your most often used files, no matter what file type, in a special section. Files added to the Favorites section will be copied here for playback in a centralized location.





 Tap to mark files for deletion from the local storage in Favorites. The file will still be accessible in other mydlink SharePort sections.

 Tapping this icon gives you additional options depending on the file type.

The bottom menu bar includes these options:

 Tap to go back to the main menu.

 Tap to update the list of files.

 Tap to reorder the files alphabetically.

Tap on a file to start the file viewer. In the viewer:

 Tap to add/remove the file from your Favorites.

 Tap to bring up additional options.

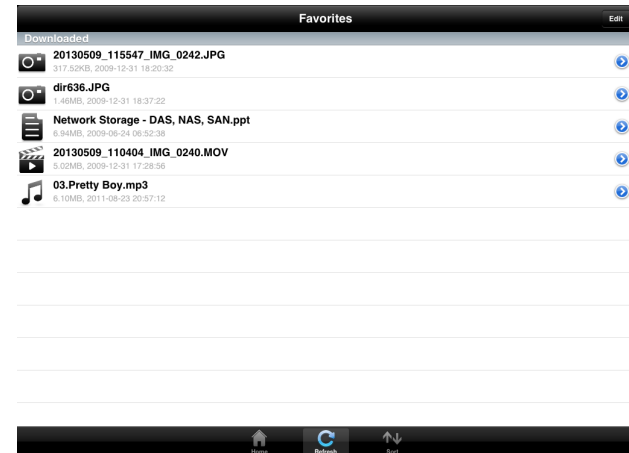

Note: The file options available will vary depending on the file type.

Using the mydlink SharePort™ app for Android™

The mydlink SharePort™ app is a streamlined mobile application that allows you to conveniently stream media and share files stored on a removable storage device connected to your router. Once the router is set up, you can start the app and easily connect from a local network or through the Internet to access your photos, videos, music, and documents. It allows you to create your own personal cloud storage. You can upload files and photos from your mobile device to the removable storage via the app from anywhere in the world!

Note: In order to ensure smooth streaming performance, you will need a minimum of 2 Mbit/s upload bandwidth for your router's Internet connection. Streaming performance will vary depending on the quality of your Internet connection.

Note: If you choose to skip the mydlink SharePort registration during the initial setup of your DIR-895L, you may begin the registration process anytime by accessing the mydlink SharePort feature from within the router configuration menu. Please see page 94 for details on how to begin the mydlink shareport registration process.

1. If you are connecting remotely through the mydlink SharePort™ app from the Internet, you will need a **mydlink** account.
2. Make sure the device is powered on. Then plug your USB drive into a USB port on the device.

Note: If you connect a removable storage device with several thousand files, it may take a while for the router to scan and catalog them.

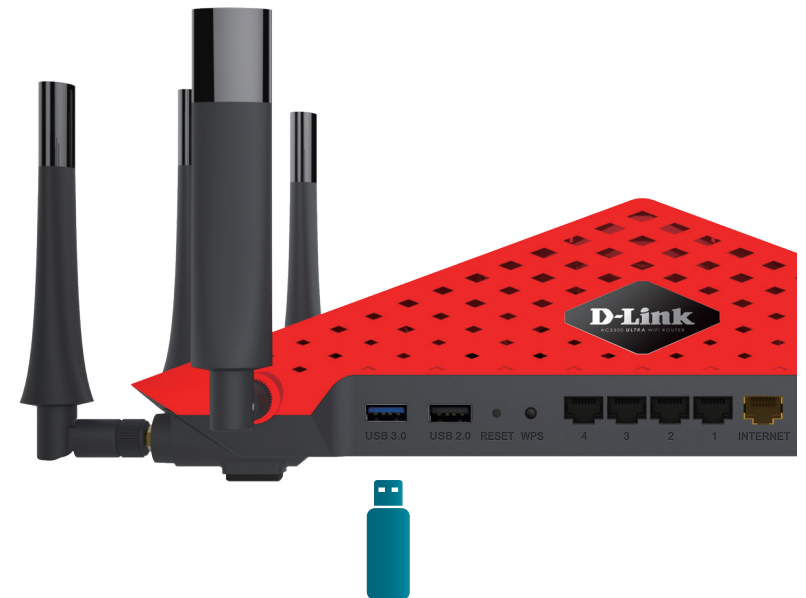

Plug your removable storage device in either the USB 2.0 or 3.0 port.

3. Use your Android mobile device to search for and download the free **mydlink SharePort** app from Google Play™.

If you have a QR code reader, you can scan the code for **mydlink SharePort** to the right.



4. Tap the **mydlink SharePort** icon, and the app will load.



5. Tap **Set up** to go to Settings and enter the Admin password and your mydlink Account Login information when the pop-up displays. Tap **Apply** when your information is entered. (The Admin password is only for local access, if you can connect through the Internet, then you can leave the Admin password blank)

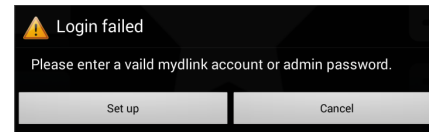

7. You can now use the mydlink SharePort app interface to stream media and access files stored on your removable drive. The wireless icon at the bottom will be lit green to indicate you are connected to the router through Remote Access.

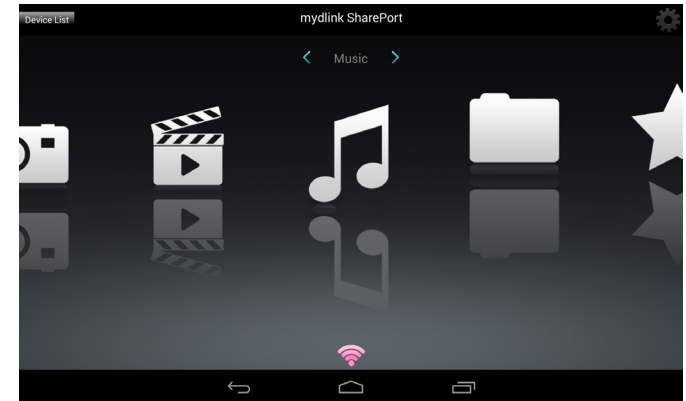

8. If you have more than one device registered to your mydlink account, you can tap **Device List** (in the top-left corner) and you will be prompted to select the device you wish to use.

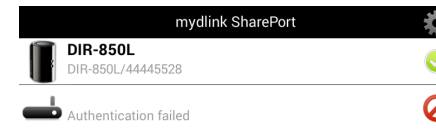

Note: A red wireless icon indicates that your router's network environment may not be optimal for streaming media and you may experience slow downs or otherwise degraded performance.

Using mydlink SharePort in a local network:

1. Make sure the device is powered on. Then plug your USB drive into the USB port of the device.

Note: If you connect a removable storage with many files or a large capacity, it may take a while for the router to scan and catalog your files.

2. Use your Android mobile device to search for and download the free **mydlink SharePort** app from Google Play™.

If you have a QR code reader, you can scan the code for **mydlink SharePort** to the right.

3. On your mobile device, go to your Wi-Fi settings and connect to your router's wireless network using the default Wi-Fi settings. Locate the Wi-Fi name (SSID) and password for your device as printed on the included Wi-Fi Configuration Card.

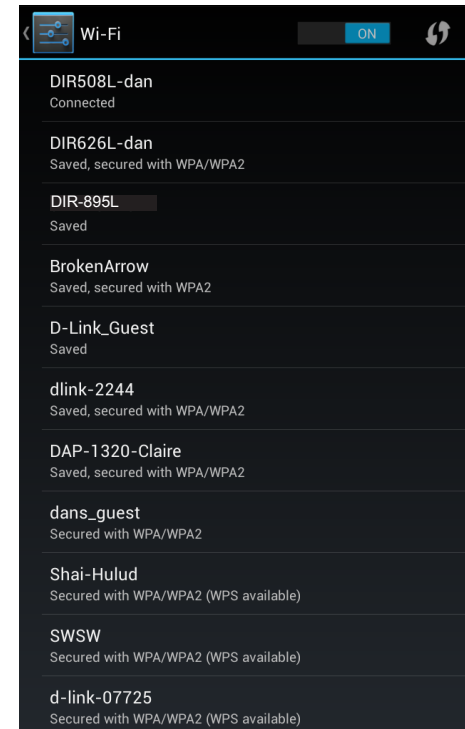

4. Tap the **mydlink SharePort** icon, and the app will load.



5. Tap **Set up** to enter the Admin password for your router when the pop-up displays.

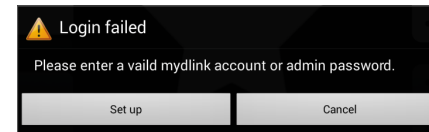

6. Enter your Admin Login in the Password field and tap **Apply**. You will be taken back to the device list where you can select the device for use with mydlink SharePort.

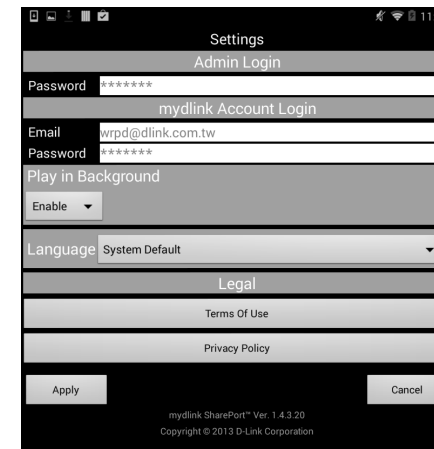

7. You can now use the mydlink SharePort app interface to stream media and access files stored on your removable drive. The wireless icon at the bottom will be lit blue to indicate a Local Access connection.

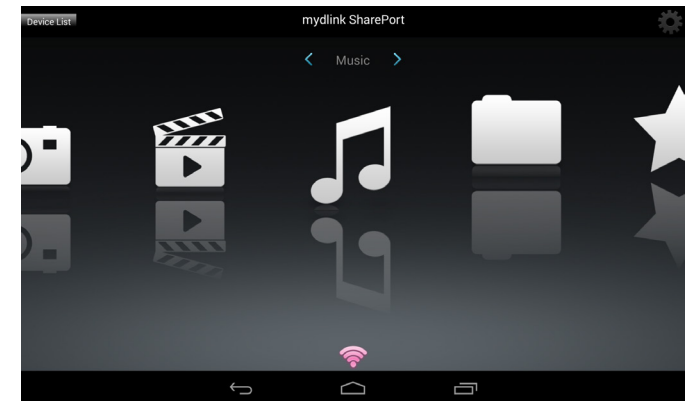

Note: A red wireless icon indicates that your router's network environment may not be optimal for streaming media and you may experience slow downs or otherwise degraded performance.

Main Menu

The mydlink SharePort main menu has different sections that let you see all the documents, photos, movies, or music stored on your removable storage. Tap < or >, or swipe left or right to move between the different sections. The Wi-Fi icon at the bottom indicates an active local network connection (blue) or remote connection (green/red). Tap **Log In** if it is not lit, or **Log Out** to return to the login page.



Tap on the document icon to view documents.



Tap the camera icon to view pictures.



Tap on the movie icon to play videos.

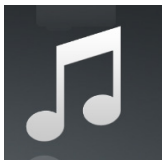

Tap on the music icon to play audio files.



Tap on the folder icon to browse all files in a folder view.

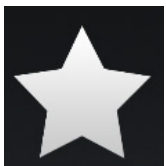

Tap on the star icon to access your favorite files.

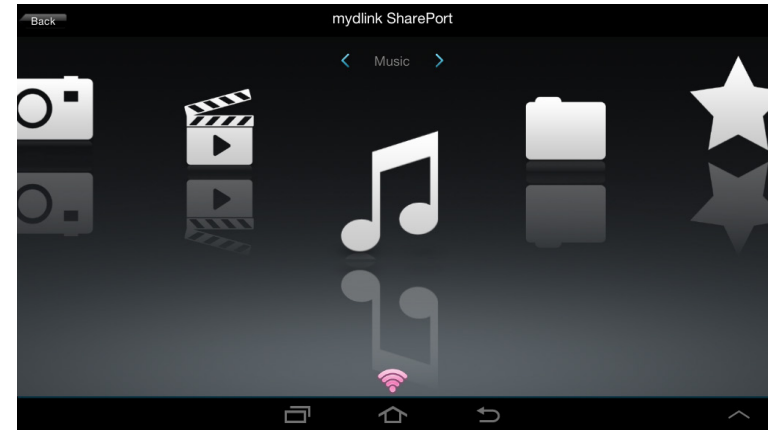

Note: Available features may differ depending on the Android OS version of your device.

Documents

The Documents section allows you to share, print, and view documents streamed from your DIR-895L to your mobile device. Tap the document icon on the main menu to browse the files on your mobile device.

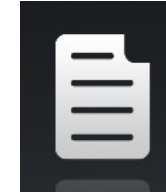

Search Bar: Type in the name of a file to search for it.



Tap to return to the main menu.



Tap to refresh, sort, or mark files for deletion.



Tap the star icon next to each file to download it to your device and add it into your Favorites section.

Tap for additional options:



Tap to return to the main menu.



Tap to update the list of files.



Tap to sort the files by name, size, type, or date.



Check a file then tap to delete it.

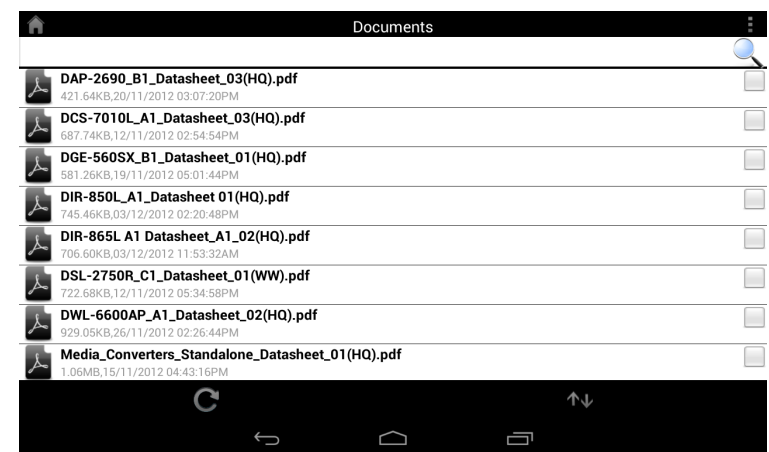
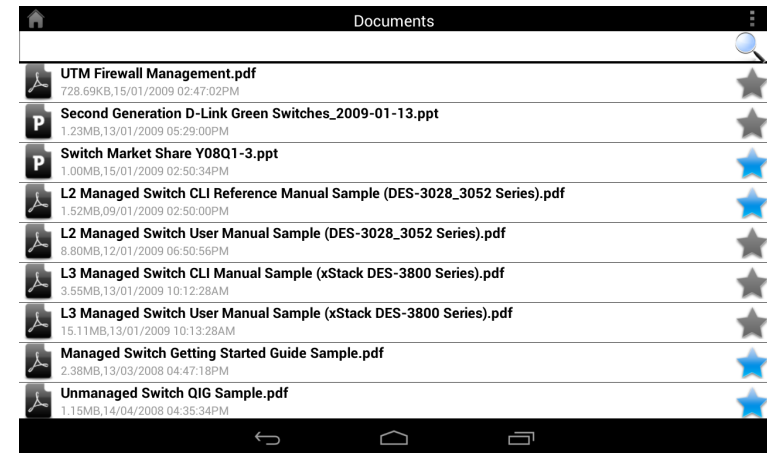

- Tap on a file to start the document viewer. In the viewer:
 - Tap the screen to bring up zoom in/out buttons.
 - Drag the screen up or down to scroll between pages.
 - Tap  to perform File, Find, Zoom, Reading View, Go To Page, and Bookmarks actions.

Note: Available actions may differ depending on your Android OS.



Pictures

The Pictures section allows you to view images streamed from your DIR-895L to your mobile device. Tap the camera icon on the main menu to browse your photo collection on your removable storage.



Search Bar: Type in the name of a file to search for it.



Tap to return to the main menu.



Tap to start a slideshow.



Tap to refresh, sort, or mark files for deletion.



Tap the star icon next to each file to download it to your device and add it into your Favorites section.

Tap for additional options:



Tap to return to the main menu.



Tap to update the list of files.







Tap to sort the files by name, size, type, or date.

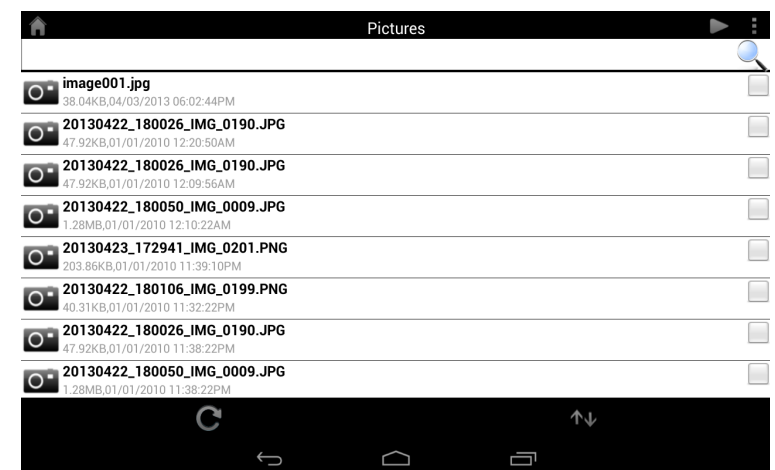
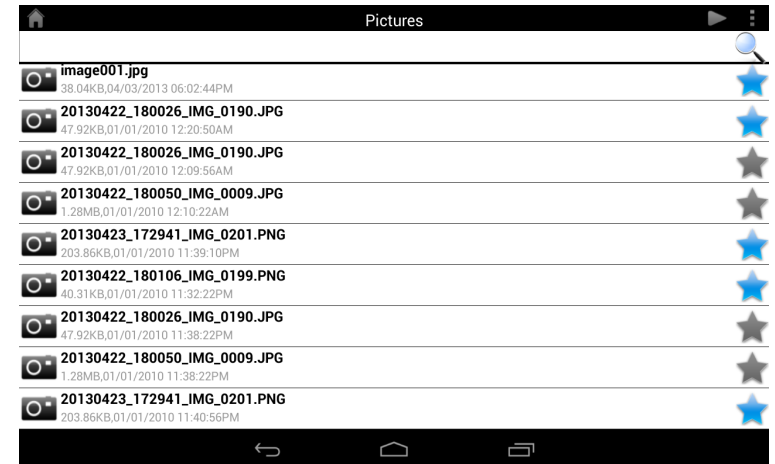

Check a file then tap to delete it.



Tap on an image file to start the image viewer. In the viewer:

-  Tap the star icon to download it to your device and add it into your Favorites section.
-  Tap to start a slideshow. Tap the image to stop the slideshow.
-  Tap to delete the current image. Tap **OK** to confirm.
-  Tap to bring up additional options using other applications.
-  Tap to access the image editor.

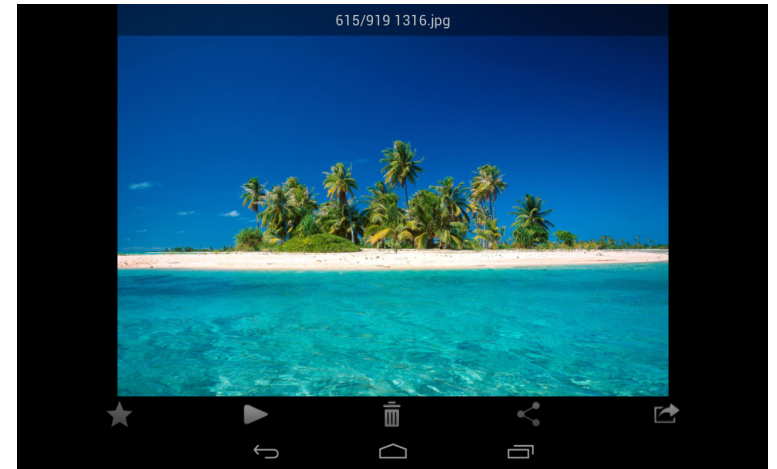

Note: This function may vary depending on the version of your Android OS.

Videos

The Videos section allows you to stream video clips and movies from your DIR-895L to your mobile device. Tap the movie icon on the main menu to browse your videos on your removable storage.



Search Bar: Type in the name of a file to search for it.



Tap to return to the main menu.



Tap to refresh, sort, or mark files for deletion.



Tap the star icon next to a file to download it to your device and add it into your Favorites section.

Tap  for additional options:



Tap to return to the main menu.



Tap to update the list of files.



Tap to sort the files by name, size, type, or date.



Check a file then tap this icon to delete it.



Tap on a file to start playing it. Tap on the screen to bring up the scroll bar, pause button, and play button.

 Tap to resume playback.

 Tap to pause the video.

Note: Available features may vary depending on the Android OS version installed on your device.

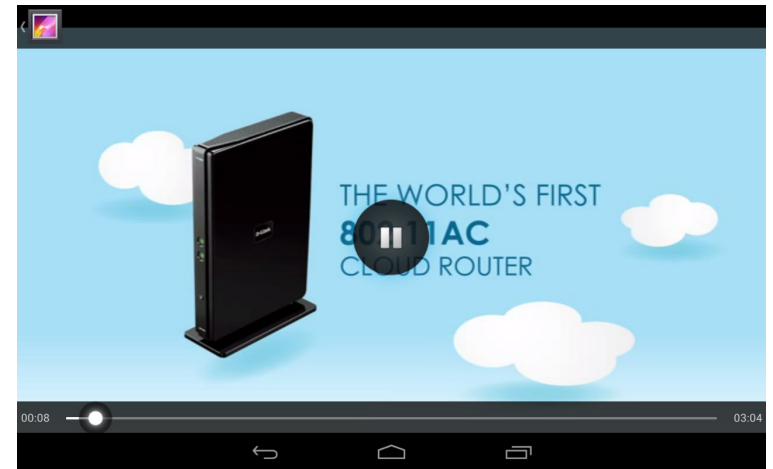

Music

The Music section allows you to stream songs from your DIR-895L to your mobile device. Tap the music icon on the main menu to browse your music collection on your removable storage.

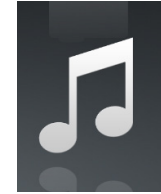

Search Bar: Type in the name of a file to search for it.



Tap to return to the main menu.



Tap to refresh, sort, or mark files for deletion.



Tap to browse your playlists.



Tap the star icon next to a file to download it to your device and add it into your Favorites section.

Tap for additional options:



Tap to return to the main menu.



Tap to update the list of files.



Tap to sort the files by name, size, type, or date.





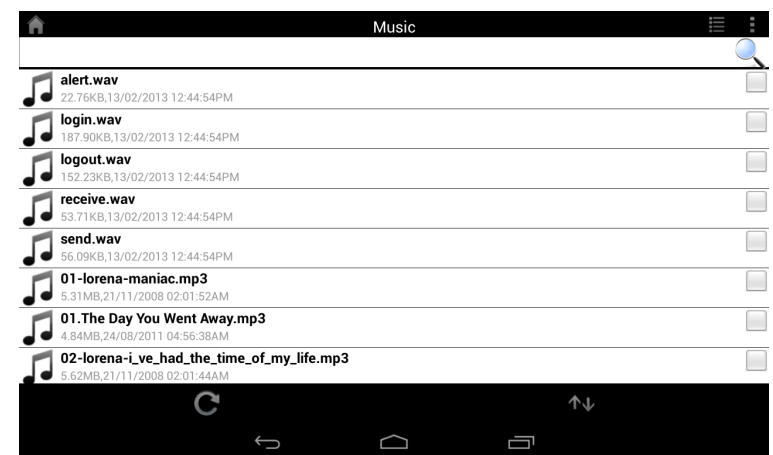
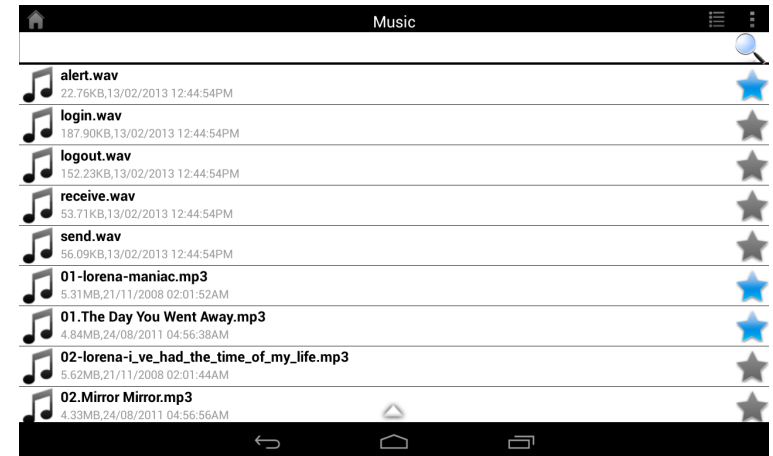

Check a file then tap this icon to delete it.



Tap on a file to start playing it. In the player:

 Tap on the up/down arrow to show/hide the player controls.

  Tap to repeat all. Tap again to repeat a single song.

  Tap to skip to the previous/next song.

 Tap to play or pause the song.

 Tap to enable/disable shuffle mode.

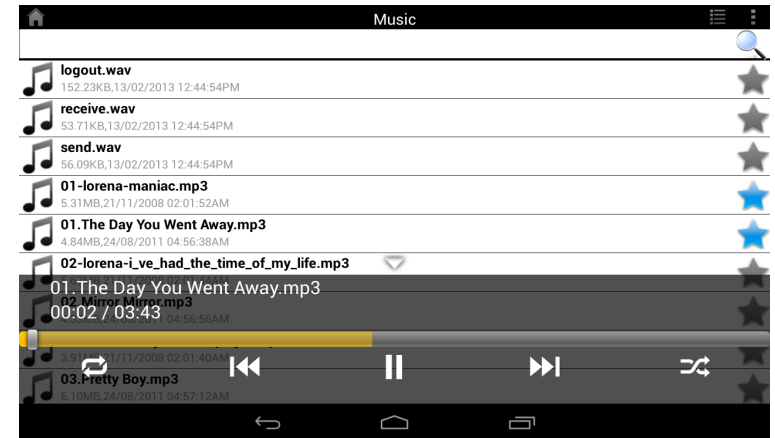

To create a playlist:

Tap 

Tap **Add new playlist...**

Enter a name for the playlist, then tap **OK**. The name of the playlist will appear in the browser next to the  icon.

You can tap  then  to refresh the playlist page.

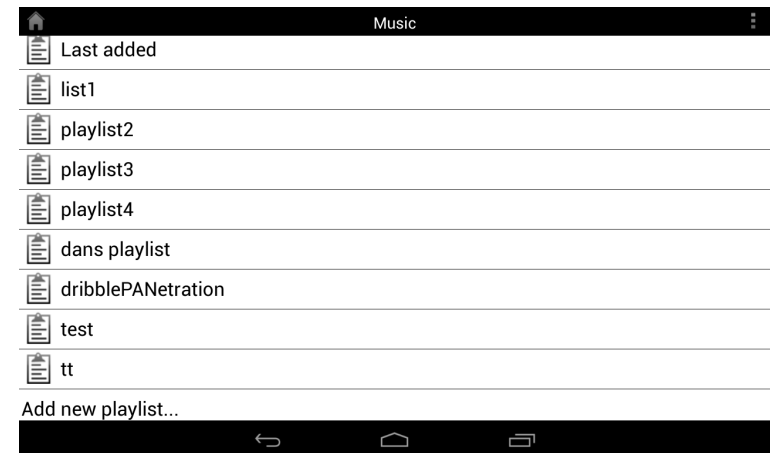

To add songs to a playlist:

Tap a playlist to see its contents.

Tap **Add Music...** to add songs to the current playlist.

Tick the songs you wish to add and tap  to save.

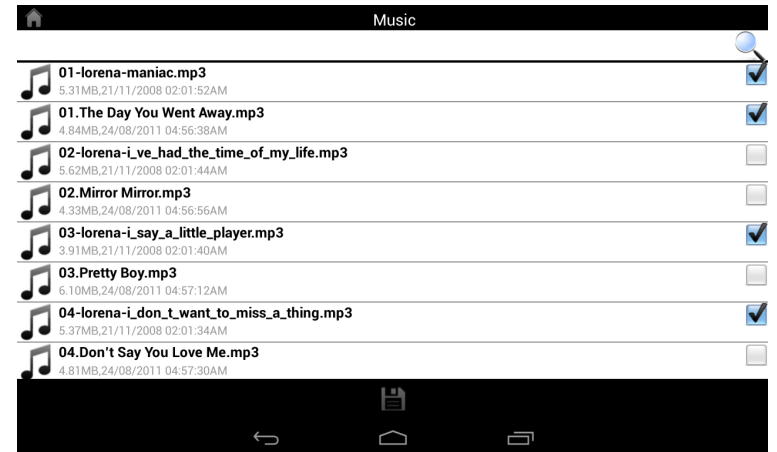

To delete songs from the playlist:

Tap **Edit** in the playlist browser and mark the files to be deleted.

Tap  then tap **OK** to confirm.

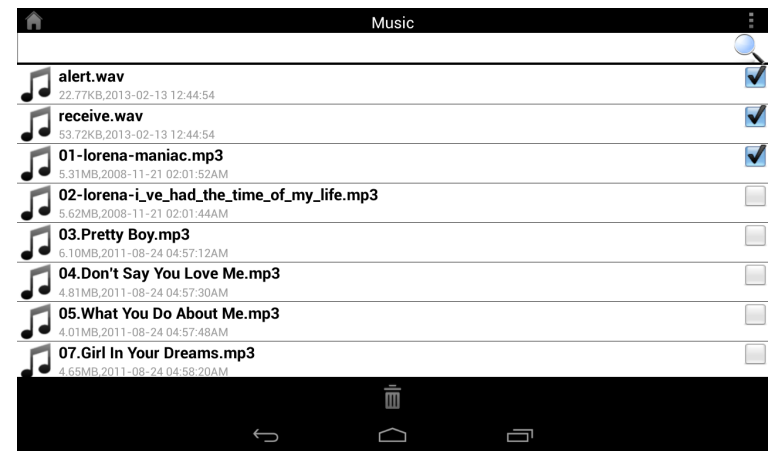

Folders

You can browse your removable storage in a folder view in the folders section. Tapping the filename will open the viewer/player for that file type as described in the previous pages. You can also upload files from your mobile device to the removable storage attached to your router.

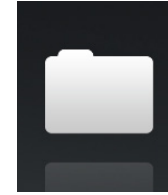

Search Bar: Type in the name of a file to search for it.



Tap to return to the main menu.



Tap to access file options.

In the file browser:



Tap to return to the main menu.







Tap to upload files.

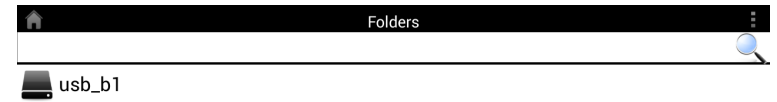

Tap to refresh, sort, create a new folder, or mark files for deletion and copying.



Tap  to select files and perform the following actions:

-  Tap to update the list of files.
-  Tap to sort the files by name, size, type, or date.
-  Tap to create a new folder.
-  Mark a file then tap this icon to delete it.
-  Mark a file then tap this icon to copy it.

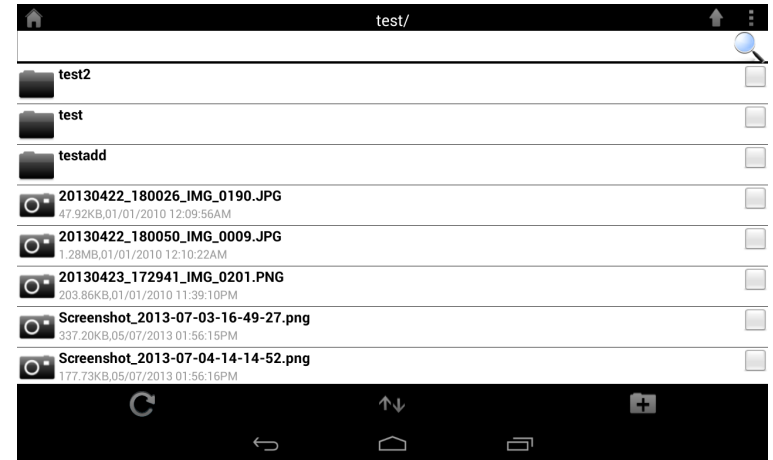

To delete files:

Tap on  and tick the box next to a file for deletion.

Tap on  to delete your selected files. Tap **OK** to confirm.

To copy files:

Tap on  to select files for copying. Tick the box next to each file for copying.

Tap on  to browse to the destination.

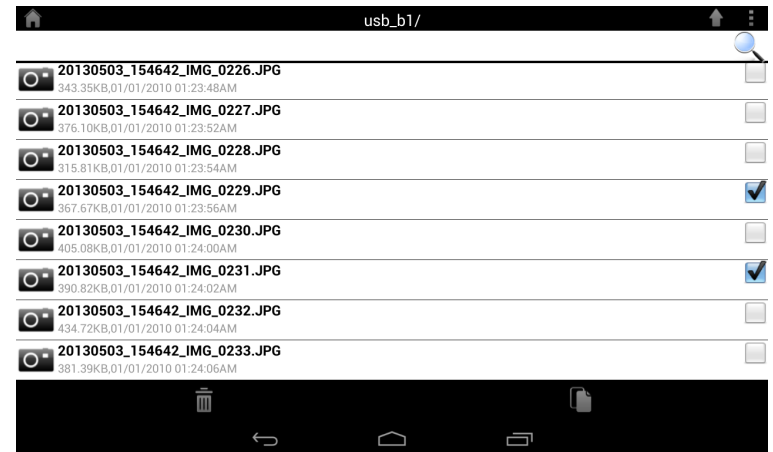

Tap **Paste** or **Cancel**.

You can also tap **New Folder** if you wish to create a folder in the current directory.

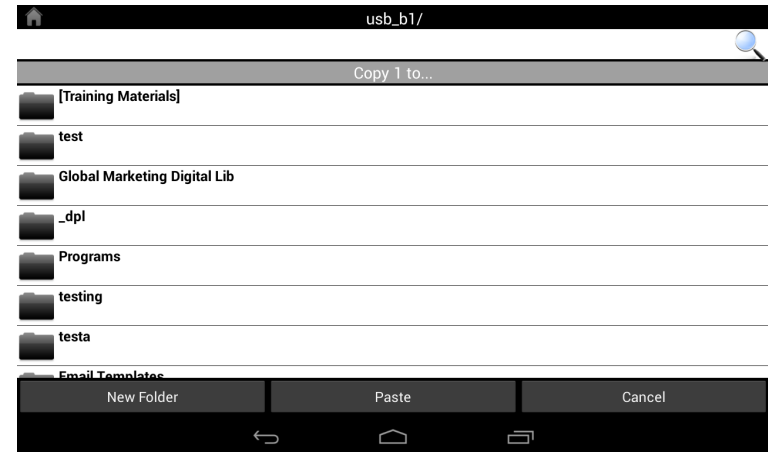

To create a new folder:

Browse to the directory you wish to create a new folder in.

Tap  then .

Enter the name of the folder in the box, then tap **OK**.

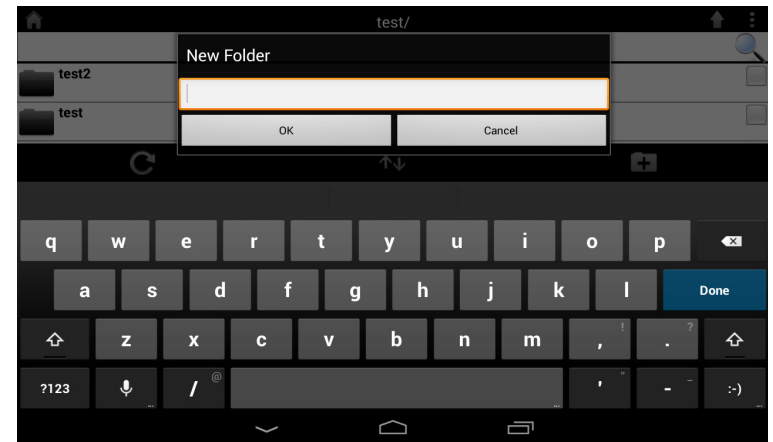

To upload images and videos from your mobile device:

Browse to the folder you wish to upload to.

Tap  and browse to the file or files you wish to upload from the local device.

Tick the box next to each of the files you wish to upload.

Tap **Upload**.

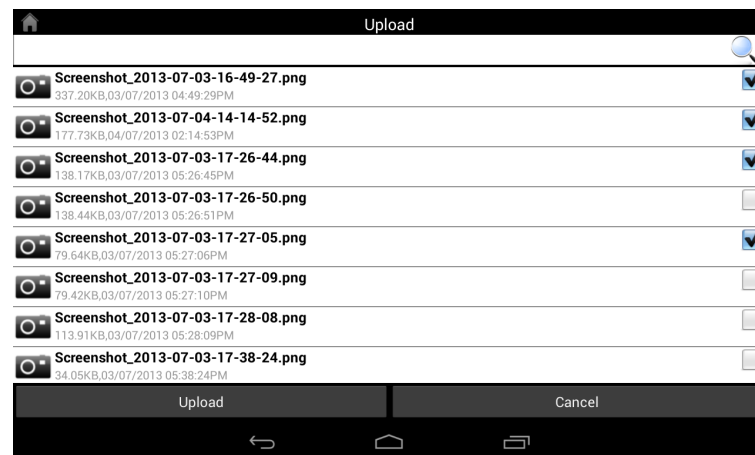

During the upload process, the size of the file and the upload progress will be displayed under the file name.

To remove a file from the upload queue, tap the X next to it.

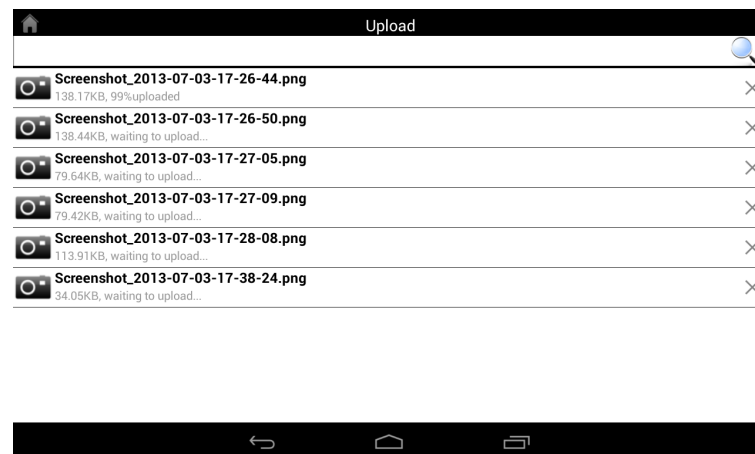

Favorites

The Favorites section allows you to quickly access your most often used files, no matter what file type, in a special section. Files added to the Favorites section will be copied here for playback in a centralized location.



Search Bar: Type in the name of a file to search for it.



Tap to return to the main menu.



Tap to refresh, sort, or mark files for deletion.

Tap  for additional options:



Tap to return to the main menu.



Tap to update the list of files.



Tap to sort the files by name, size, type, or date.



Check a file then tap to delete it.

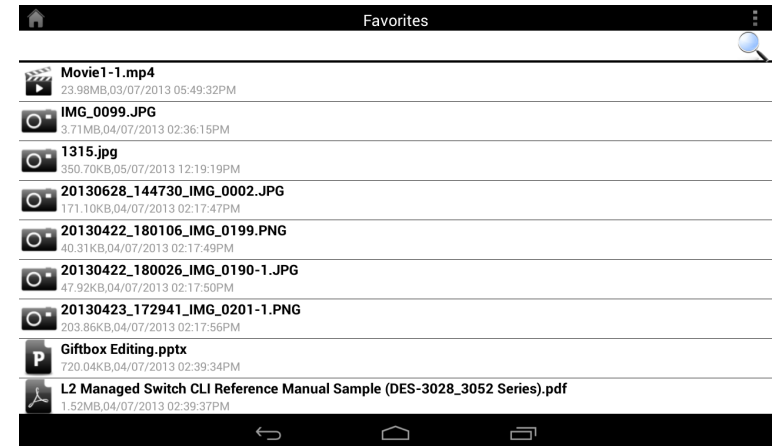

Configuration

To access the configuration utility, open a web-browser such as Internet Explorer and enter **http://dlinkrouter.local/**

Windows and Mac users may also connect by typing the IP address of the router (by default this is **http://192.168.0.1**) in the address bar.

Enter your password. If you previously followed the setup wizard (see page 14), please use the admin password you entered during the wizard. Otherwise, leave the password blank. Click **Log In** to proceed.

Note: If you cannot remember your password and cannot log in, press the reset button (see page 6) to restore the router to its default settings.

The router's home page will open displaying its current connection status.

The bar at the top of the page has quick access to Settings and Management functions. You may quickly jump back Home at any time.

Note: The system will automatically log out after a period of inactivity.

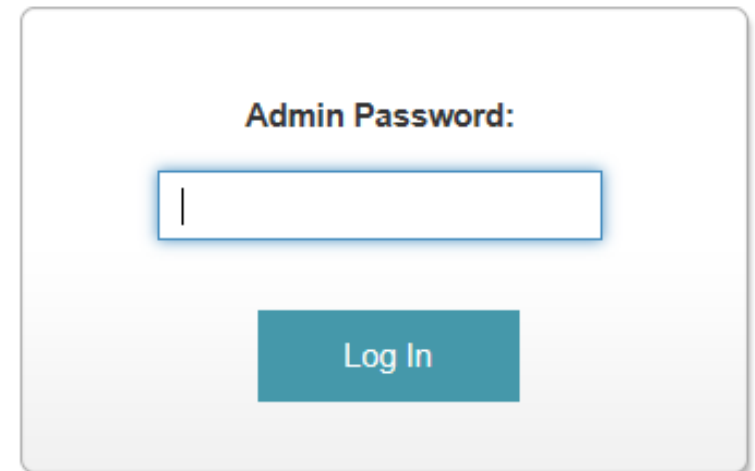
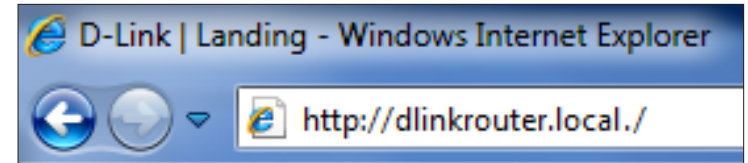

Home

The Home page displays the current status of the router in the form of an interactive diagram. You can click each icon to display information about each part of the network at the bottom of the screen. The menu bar at the top of the page will allow you to quickly navigate to other pages.

Internet

The Home page displays whether or not the router is currently connected to the Internet. If it is disconnected, click **Click to repair** to bring up the setup wizard (see page 14).

To bring up more details about your Internet connection, click on the **Internet** icon. Click **IPv4** or **IPv6** to see details of the IPv4 connection and IPv6 connection respectively.

Click **Release** to disconnect from the Internet. If you do this and wish to reconnect, click **Renew**.

To reconfigure the Internet settings, refer to page 68.

● Internet Disconnected

Click on any item in the diagram for more information.



D-Link
DIR-895L HW:A1 FW:1.00
Home | Settings | Advanced | Management

● Internet Connected

Click on any item in the diagram for more information.

Internet

DIR-895L

Connected Clients: 1

Internet

DIR-895L

USB Device

Internet

<p>Cable Status: Connected</p> <p>Connection Type: Dynamic IP (DHCP)</p> <p>Network Status: Connected</p> <p>Connection Uptime: 0 Day 0 Hour 1 Min 1 Sec</p> <p style="text-align: center;">Release IP Address</p>	<p style="text-align: right;">IPv4 / IPv6</p> <p>MAC Address: 00:CA:FE:08:90:05</p> <p>IP Address: 172.17.5.158</p> <p>Subnet Mask: 255.255.255.0</p> <p>Default Gateway: 172.17.5.254</p> <p>Primary DNS Server: 192.168.168.249</p> <p>Secondary DNS Server: 192.168.168.201</p> <p style="text-align: right;">Go to settings</p>
--	--

DIR-895L

Click on the **DIR-895L** icon to view details about the router and its wireless settings.

Here you can see the router's current wireless settings, as well as its MAC address and IPv4/IPv6 addresses.

To reconfigure the network settings, either click **Go to settings** on the lower left, or click **Settings** (at the top of the page) and then **Network** on the menu that appears. Refer to page 95.

To reconfigure the wireless settings, either click **Go to settings** (lower right of the screen) or click **Settings** (at the top of the page) and then **Wireless** on the menu that appears. Refer to page 92.

The screenshot displays the D-Link DIR-895L web interface. At the top, there is a navigation bar with 'Home', 'Settings', 'Advanced', and 'Management' tabs. Below the navigation bar, a green circle indicates 'Internet Connected'. A network diagram shows the router (DIR-890L) connected to the Internet, with a green checkmark indicating a successful connection. The diagram also shows 'Connected Clients: 1' and a 'USB Device' connected to the router.

Below the diagram, the 'DIR-895L' settings are displayed in a grid format:

Network Type	MAC Address	Router IP Address	Subnet Mask	Status	Wi-Fi Name (SSID)	Password
IPV4 Network	00:CA:FE:08:90:00	192.168.0.1	255.255.255.0	Enabled	dlink-9000	1234567890
IPV6 Network	FE80::2CA:FEFF:FE08:9000	Not Available		Enabled	dlink-9000-5GHz-lo	1234567890
				Enabled	dlink-9000-5GHz-hi	1234567890

At the bottom of the settings grid, there is a 'Go to settings' button with a right-pointing arrow. The footer of the page contains 'COPYRIGHT © 2014 D-Link' and a 'Get Help' link.

Connected Clients

Click on the **Connected Clients** icon to view details about the router and its wireless settings.

On this page you can see all the clients currently connected to the router, and their IP addresses.

To edit each client's settings, click the pencil icon on the client you want to edit.

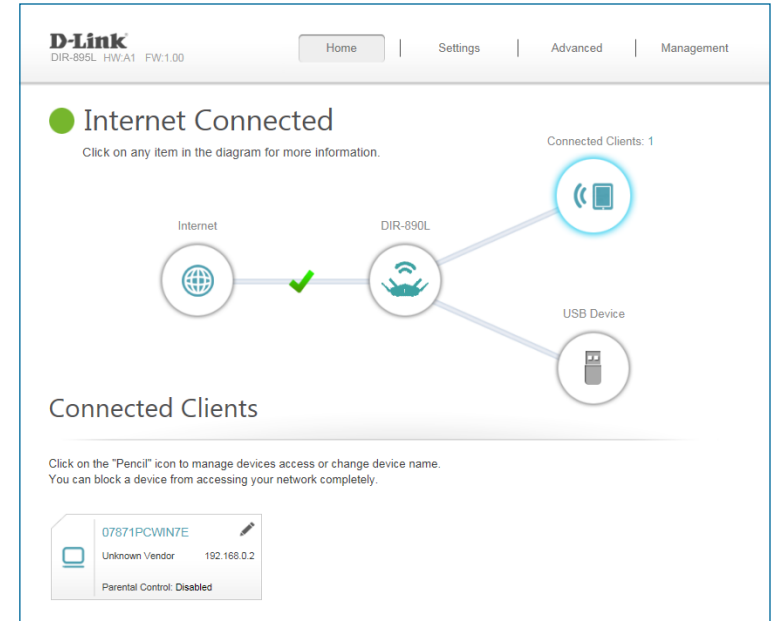

Name: Enter a custom name for this client.

Vendor: Displays the vendor of the device.

MAC Address: Displays the MAC address of the device.

IP Address: Enter a specific IP address for this client.

Reserve IP: Enable to reserve this IP address for this client.

Parental Control: Allow or Block access to the router.

Click **Save** when you are done.

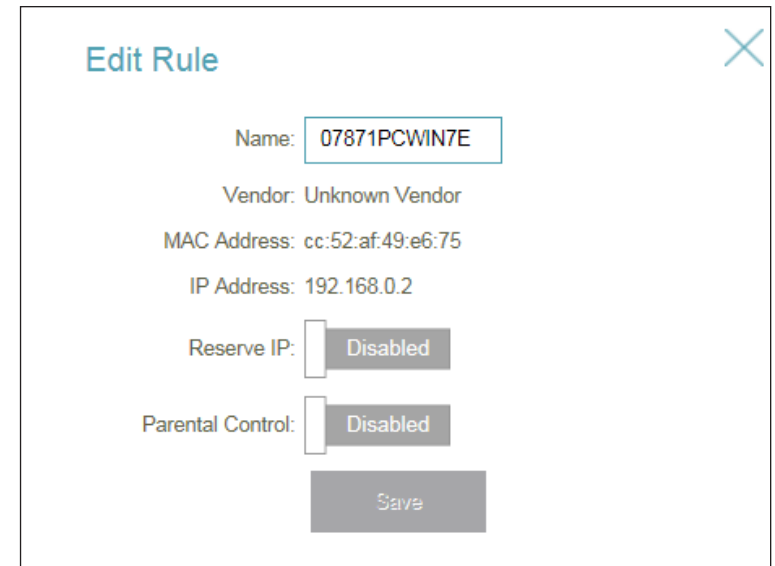

USB Device

Click on the **USB Device** icon to view details about the currently connected USB device, DLNA media server, SharePort, and Windows File Sharing.

If you have a USB device connected, you can see its name and how much free space it has.

To configure your SharePort settings, click **Go to settings** and refer to page 97.

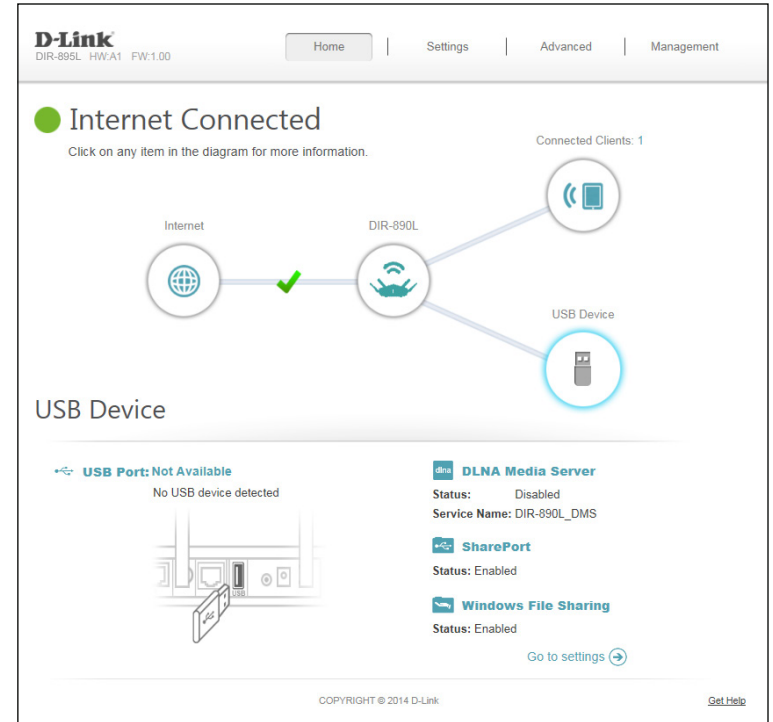

Settings Wizard

In the Settings menu on the bar on the top of the page, click **Wizard** to open the setup wizard. This is the same wizard that appears when you start the router for the first time. Refer to page 14 for details.

Internet

In the Settings menu on the bar on the top of the page, click **Internet** to see the Internet configuration options.

My Internet Choose your Internet connection type from the drop-down menu.
Connection Is: You will be presented with the appropriate options for your connection type. Click **Advanced Settings...** to expand the list and see all of the options.

For **Dynamic IP (DHCP)** refer to page 69.

For **Static IP** refer to page 70.

For **PPPoE** refer to page 71.

For **PPTP** refer to page 72.

For **L2TP** refer to page 74.

For **DS-Lite** refer to page 76.

To configure an IPv6 connection, click the **IPv6** link. Refer to page 77.

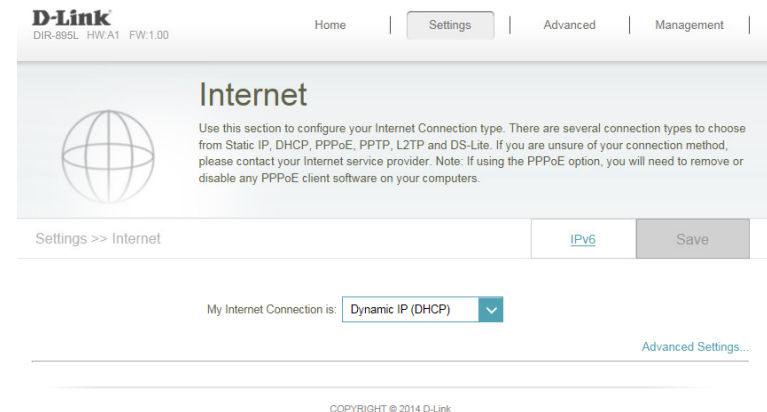

Dynamic IP (DCHP)

Select **Dynamic IP (DHCP)** to obtain IP address information automatically from your Internet Service Provider (ISP). Select this option if your ISP does not give you an IP address to use.

Host Name: The host name is optional but may be required by some ISPs. Leave it blank if you are not sure.

Primary DNS Server: Enter the primary DNS server IP address assigned by your ISP. This address is usually obtained automatically from your ISP.

Secondary DNS Server: Enter the secondary DNS server IP address assigned by your ISP. This address is usually obtained automatically from your ISP.

MTU: Maximum Transmission Unit - you may need to change the MTU for optimal performance with your ISP.

MAC Address Clone: The default MAC address is set to the Internet port's physical interface MAC address on the router. You can use the drop-down menu to replace the Internet port's MAC address with the MAC address of a connected client.

Click **Save** when you are done.

The screenshot displays the 'Internet' configuration page in the D-Link router's web interface. At the top, there is a navigation bar with 'Home', 'Settings', 'Features', and 'Management' tabs. Below this, the 'Internet' section is titled with a globe icon and a brief instruction: 'Use this section to configure your Internet Connection type. There are several connection types to choose from Static IP, DHCP, PPPoE, PPTP, L2TP and DS-Lite. If you are unsure of your connection method, please contact your Internet service provider. Note: If using the PPPoE option, you will need to remove or disable any PPPoE client software on your computers.' The main configuration area shows 'My Internet Connection is:' set to 'Dynamic IP (DHCP)'. Below this, there are input fields for 'Host Name' (containing 'dlinkrouter'), 'Primary DNS Server', and 'Secondary DNS Server'. The 'MTU' is set to 'Auto' via a dropdown menu. The 'Mac Address Clone' field contains 'F8:E9:03:B9:8B:1F' and has a dropdown menu labeled '<< MAC Address'. A 'Save' button is located in the top right corner of the configuration area. The footer of the page reads 'COPYRIGHT © 2014 D-LINK'.

Static IP

Select **Static IP** if your IP information is provided by your Internet service provider (ISP).

IP Address: Enter the IP address provided by your ISP.

Subnet Mask: Enter the subnet mask provided by your ISP.

Default Gateway: Enter the default gateway address provided by your ISP.

Primary DNS Server: Enter the primary DNS server IP address assigned by your ISP.

Secondary DNS Server: Enter the secondary DNS server IP address assigned by your ISP.

MTU: Maximum Transmission Unit - you may need to change the MTU for optimal performance with your ISP.

MAC Address Clone: The default MAC address is set to the Internet port's physical interface MAC address on the router. You can use drop-down menu to replace the Internet port's MAC address with the MAC address of a connected client.

Click **Save** when you are done.

The screenshot shows the D-Link Web UI for the DIR-895L. The top navigation bar includes 'Home', 'Settings', 'Features', and 'Management'. The main heading is 'Internet'. Below the heading is a globe icon and a note: 'Use this section to configure your Internet Connection type. There are several connection types to choose from Static IP, DHCP, PPPoE, PPTP, L2TP and DS-Lite. If you are unsure of your connection method, please contact your Internet service provider. Note: If using the PPPoE option, you will need to remove or disable any PPPoE client software on your computers.'

The configuration area includes a 'Settings >> Internet' breadcrumb and a 'Save' button. A 'IPv6' tab is also present. The 'My Internet Connection is' dropdown is set to 'Static IP'. Below this are input fields for 'IP Address', 'Subnet Mask', 'Default Gateway', and 'Primary DNS Server'. An 'Advanced Settings...' link is located below these fields. Further down, there are fields for 'Secondary DNS Server', 'MTU' (set to 'Auto'), and 'Mac Address Clone' (set to '<< MAC Address').

At the bottom of the page, it says 'COPYRIGHT © 2014 D-Link'.

PPPoE

Select **PPPoE** if your Internet connection requires you to enter a username and password. This information is provided by your Internet service provider (ISP).

Username: Enter the username provided by your ISP.

Password: Enter the password provided by your ISP.

Reconnect Mode: Select either **Always-on**, **On-Demand**, or **Manual**.

Maximum Idle Time: Enter a maximum idle time during which the Internet connection is maintained during inactivity. To disable this feature, enable Auto-reconnect.

Address Mode: Select **Static IP** if your ISP assigned you the IP address, subnet mask, gateway, and DNS server addresses. In most cases, select **Dynamic IP**.

IP Address: Enter the IP address provided by your ISP (Static IP only).

Service Name: Enter the ISP service name (optional).

Primary DNS Server: Enter the primary DNS server IP address assigned by your ISP.

Secondary DNS Server: Enter the secondary DNS server IP address assigned by your ISP.

MTU: Maximum Transmission Unit - you may need to change the MTU for optimal performance with your ISP.

MAC Address Clone: The default MAC address is set to the Internet port's physical interface MAC address on the router. You can use the drop-down menu to replace the Internet port's MAC address with the MAC address of a connected client.

Click **Save** when you are done.

The screenshot shows the D-Link web interface for the DIR-895L router. The page is titled "Internet" and contains the following configuration options:

- My Internet Connection is:** PPPoE (selected)
- Username:** [Empty text box]
- Password:** [Empty text box]
- Reconnect Mode:** On demand (selected)
- Maximum Idle Time:** 5 minutes
- Address Mode:** Dynamic IP (selected)
- Service Name:** [Empty text box]
- Primary DNS Server:** [Empty text box]
- Secondary DNS Server:** [Empty text box]
- MTU:** Auto (selected)
- Mac Address Clone:** [Empty text box] with a dropdown menu set to "<< MAC Address"

Buttons for "IPv6" and "Save" are visible. A "Save" button is also present at the top right of the page. The footer indicates "COPYRIGHT © 2015 D-Link".

PPTP

Choose **PPTP** (Point-to-Point-Tunneling Protocol) if your Internet Service Provider (ISP) uses a PPTP connection. Your ISP will provide you with a username and password.

PPTP Server IP Enter the PPTP server IP address provided by your ISP.

Address:

Username: Enter the username provided by your ISP.

Password: Enter the password provided by your ISP.

Reconnect Mode: Select either **Always-on**, **On-Demand**, or **Manual**.

Maximum Idle Time: Enter a maximum idle time during which the Internet connection is maintained during inactivity. To disable this feature, enable Auto-reconnect.

Address Mode: Select **Static IP** if your ISP assigned you the IP address, subnet mask, gateway, and DNS server addresses. In most cases, select **Dynamic IP**.

PPTP IP Address: Enter the IP address provided by your ISP (Static IP only).

PPTP Subnet Mask: Enter the subnet mask provided by your ISP (Static IP only).

PPTP Gateway IP Address: Enter the gateway IP address provided by your ISP (Static IP only).

Primary DNS Server: Enter the primary DNS server IP address assigned by your ISP.

The screenshot shows the D-Link web interface for the DIR-895L router. The page is titled "Internet" and contains the following configuration fields:

- My Internet Connection is:** PPTP (dropdown menu)
- PPTP Server IP Address:** (text input field)
- Username:** (text input field)
- Password:** (text input field)
- Reconnect Mode:** On demand (dropdown menu)
- Maximum Idle Time:** 5 minutes (text input field)
- Address Mode:** Dynamic IP (dropdown menu)
- Primary DNS Server:** (text input field)
- Secondary DNS Server:** (text input field)
- MTU:** Auto (dropdown menu)

There is a "Save" button and an "Advanced Settings..." link at the bottom right of the configuration area.

Secondary DNS Server: Enter the secondary DNS server IP address assigned by your ISP.

MTU: Maximum Transmission Unit - you may need to change the MTU for optimal performance with your ISP.

Click **Save** when you are done.

The screenshot shows the 'Internet' configuration page in the D-Link web interface. At the top, there is a navigation bar with 'Home', 'Settings', 'Features', and 'Management'. The page title is 'Internet' with a globe icon. Below the title, there is a brief instruction: 'Use this section to configure your Internet Connection type. There are several connection types to choose from Static IP, DHCP, PPPoE, PPTP, L2TP and DS-Lite. If you are unsure of your connection method, please contact your Internet service provider. Note: If using the PPPoE option, you will need to remove or disable any PPPoE client software on your computers.'

The main configuration area is titled 'Settings >> Internet' and includes a 'Save' button. The settings are as follows:

- My Internet Connection is: **PPTP** (dropdown menu)
- PPTP Server IP Address:
- Username:
- Password:
- Reconnect Mode: **On demand** (dropdown menu)
- Maximum Idle Time: minutes

Below these settings is a link for 'Advanced Settings...'. The bottom section of the page includes:

- Address Mode: **Dynamic IP** (dropdown menu)
- Primary DNS Server:
- Secondary DNS Server:
- MTU: **Auto** (dropdown menu)

At the bottom of the page, there is a copyright notice: 'COPYRIGHT © 2014 D-Link'.

L2TP

Choose **L2TP** (Layer 2 Tunneling Protocol) if your Internet Service Provider (ISP) uses a L2TP connection. Your ISP will provide you with a username and password.

L2TP Server IP Address: Enter the L2TP server IP address provided by your ISP.

Username: Enter the username provided by your ISP.

Password: Enter the password provided by your ISP.

Reconnect Mode: Select either **Always-on**, **On-Demand**, or **Manual**.

Maximum Idle Time: Enter a maximum idle time during which the Internet connection is maintained during inactivity. To disable this feature, enable Auto-reconnect.

Address Mode: Select **Static IP** if your ISP assigned you the IP address, subnet mask, gateway, and DNS server addresses. In most cases, select **Dynamic IP**.

L2TP IP Address: Enter the IP address provided by your ISP (Static IP only).

L2TP Subnet Mask: Enter the subnet mask provided by your ISP (Static IP only).

L2TP Gateway IP Address: Enter the gateway IP address provided by your ISP (Static IP only).

Primary DNS Server: Enter the primary DNS server IP address assigned by your ISP.

The screenshot shows the 'Internet' configuration page in the D-Link web interface. The page has a navigation bar with 'Home', 'Settings', 'Features', and 'Management'. The main heading is 'Internet' with a globe icon. Below the heading is a brief instruction: 'Use this section to configure your Internet Connection type. There are several connection types to choose from Static IP, DHCP, PPPoE, PPTP, L2TP and DS-Lite. If you are unsure of your connection method, please contact your Internet service provider. Note: If using the PPPoE option, you will need to remove or disable any PPPoE client software on your computers.' The page is divided into two sections. The top section is for 'My Internet Connection is:' with a dropdown menu set to 'L2TP'. Below this are input fields for 'L2TP Server IP Address', 'Username', and 'Password'. The 'Reconnect Mode:' dropdown is set to 'On demand', and the 'Maximum Idle Time:' is set to '5 minutes'. The bottom section is for 'Address Mode:' with a dropdown menu set to 'Dynamic IP'. Below this are input fields for 'Primary DNS Server' and 'Secondary DNS Server', and the 'MTU:' dropdown is set to 'Auto'. A 'Save' button is located in the top right corner of the configuration area. The footer of the page reads 'COPYRIGHT © 2014 D-Link'.

Secondary DNS Server: Enter the secondary DNS server IP address assigned by your ISP.

MTU: Maximum Transmission Unit - you may need to change the MTU for optimal performance with your ISP.

Click **Save** when you are done.

The screenshot shows the 'Internet' configuration page in the D-Link web interface. The page title is 'Internet' and it includes a globe icon. Below the title, there is a brief instruction: 'Use this section to configure your Internet Connection type. There are several connection types to choose from: Static IP, DHCP, PPPoE, PPTP, L2TP and DS-Lite. If you are unsure of your connection method, please contact your Internet service provider. Note: If using the PPPoE option, you will need to remove or disable any PPPoE client software on your computers.' The page has a navigation bar with 'Home', 'Settings', 'Features', and 'Management'. The 'Settings' tab is active. Below the navigation bar, there is a breadcrumb 'Settings >> Internet' and a 'Save' button. The main content area contains the following fields: 'My Internet Connection is:' with a dropdown menu set to 'L2TP'; 'L2TP Server IP Address:' with an empty text input; 'Username:' with an empty text input; 'Password:' with an empty text input; 'Reconnect Mode:' with a dropdown menu set to 'On demand'; 'Maximum Idle Time:' with a text input set to '5' and the unit 'minutes'; 'Address Mode:' with a dropdown menu set to 'Dynamic IP'; 'Primary DNS Server:' with an empty text input; 'Secondary DNS Server:' with an empty text input; and 'MTU:' with a dropdown menu set to 'Auto'. There is an 'Advanced Settings...' link on the right side of the page. At the bottom, there is a copyright notice: 'COPYRIGHT © 2014 D-Link'.

DS-Lite

DS-Lite is an IPv6 connection type. After selecting DS-Lite, the following parameters will be available for configuration:

DS-Lite Configuration: Select **DS-Lite DHCPv6** to let the router allocate the AFTR IPv6 address automatically. Select **Manual Configuration** to enter the AFTR IPv6 address manually.

AFTR IPv6 Address: If you selected Manual Configuration above, enter the AFTR IPv6 address used here.

B4 IPv6 Address: Enter the B4 IPv4 address value used here.

WAN IPv6 Address: Once connected, the WAN IPv6 address will be displayed here.

IPv6 WAN Default Gateway: Once connected, the IPv6 WAN default gateway address will be displayed here.

Click **Save** when you are done.

The screenshot shows the D-Link web interface for the DIR-895L router. The page is titled "Internet" and includes a navigation menu with "Home", "Settings", "Features", and "Management". The "Settings" menu is active, and the "IPv6" sub-menu is selected. The "Save" button is visible in the top right corner.

The main content area shows the "My Internet Connection is:" dropdown menu set to "DS-Lite". Below this, the "DS-Lite Configuration:" dropdown menu is set to "DS-Lite DHCPv6 Option". The "B4 IPv4 Address:" field is set to "192.0.0.". The "WAN IPv6 Address:" and "IPv6 WAN Default Gateway:" fields are both set to "N/A".

At the bottom of the page, there is a copyright notice: "COPYRIGHT © 2014 D-Link".

IPv6

To configure an IPv6 connection, click the **IPv6** link. To return to the IPv4 settings, click **IPv4**.

My Internet Connection Is: Choose your IPv6 connection type from the drop-down menu. You will be presented with the appropriate options for your connection type. Click **Advanced Settings...** to expand the list and see all of the options.

For **Auto Detection** refer to page 78.

For **Static IPv6** refer to page 80.

For **Auto Configuration (SLAAC/DHCPv6)** refer to page 82.

For **PPPoE** refer to page 84.

For **IPv6 in IPv4 Tunnel** refer to page 86.

For **6 to 4** refer to page 88.

For **6rd** refer to page 89.

For **Local Connectivity Only** refer to page 91.

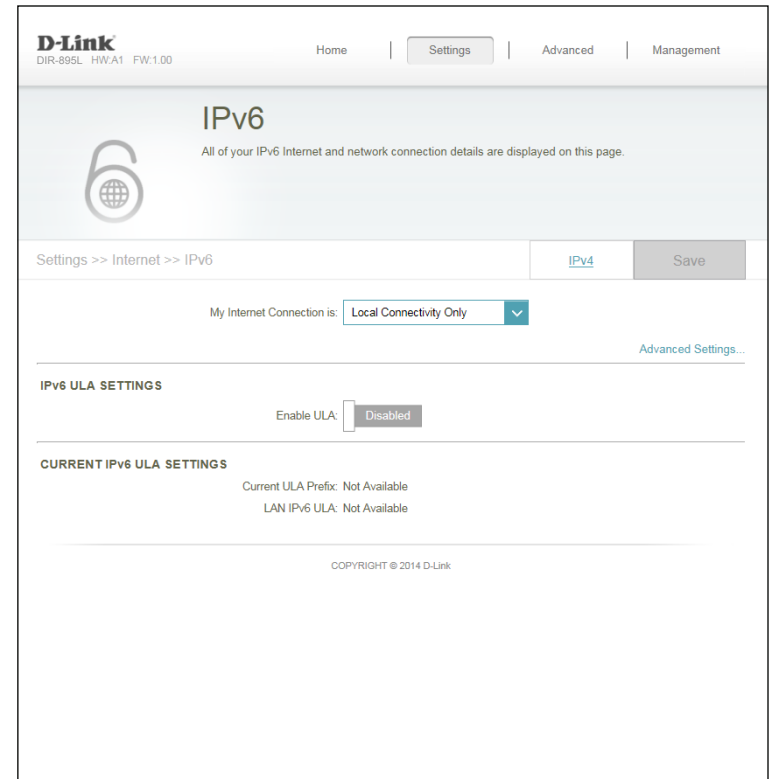

Auto Detection

This is a connection method where the ISP assigns your IPv6 address when your router requests one from the ISP's server. Some ISPs require you to make some settings on your side before your router can connect to the IPv6 Internet.

DNS Type: Select either **Obtain DNS server address automatically** or **Use the following DNS address**.

Primary DNS Server: If you selected **Use the following DNS address** above, enter the primary DNS server address.

Secondary DNS Server: If you selected **Use the following DNS address** above, enter the secondary DNS server address.

Enable DHCP-PD: Enable or disable prefix delegation services.

LAN IPv6 Address: If you disabled DHCP-PD, enter the LAN (local) IPv6 address for the router.

LAN IPv6 Link-Local Address: Displays the router's LAN link-local address.

Enable Automatic IPv6 Address Assignment: Enable or disable the Automatic IPv6 Address Assignment feature.

Enable Automatic DHCP-PD in LAN: Enable or disable DHCP-PD for other IPv6 routers connected to the LAN interface.

Note: This feature requires a smaller subnet prefix than /64 (i.e. allowing for a larger address allocation), such as /63. Contact your ISP for more information.

The screenshot displays the IPv6 configuration interface for a D-Link DIR-895L router. The page title is "IPv6" and it includes a navigation menu with "Home", "Settings", "Advanced", and "Management". The main content area shows the following settings:

- My Internet Connection is:** Auto Detection (dropdown menu)
- IPv6 DNS SETTINGS:** DNS Type: Obtain a DNS server address (dropdown menu)
- LAN IPv6 ADDRESS SETTINGS:**
 - Enable DHCP-PD: Enabled (checkbox)
 - LAN IPv6 Link-Local Address: Not Available
- ADDRESS AUTOCONFIGURATION SETTINGS:**
 - Enable Automatic IPv6 Address Assignment: Enabled (checkbox)
 - Enable Automatic DHCP-PD in LAN: Enabled (checkbox)
 - Autoconfiguration Type: SLAAC+Stateless DHCP (dropdown menu)
 - Router Advertisement Lifetime: [] minutes

At the bottom of the page, there is a copyright notice: "COPYRIGHT © 2014 D-Link".

Auto Configuration Type: Select **Stateful (DHCPv6)**, **SLAAC + RDNSS** or **SLAAC + Stateless DHCPv6**.

Router Advertisement Lifetime: Enter the IPv6 address lifetime (in minutes).

Click **Save** when you are done.

The screenshot displays the IPv6 configuration interface for a D-Link DIR-895L router. The page is titled "IPv6" and includes a navigation menu with "Home", "Settings", "Advanced", and "Management". The main content area shows the following settings:

- My Internet Connection is:** Auto Detection
- IPv6 DNS SETTINGS:** DNS Type: Obtain a DNS server address
- LAN IPv6 ADDRESS SETTINGS:** Enable DHCP-PD: Enabled; LAN IPv6 Link-Local Address: Not Available
- ADDRESS AUTOCONFIGURATION SETTINGS:** Enable Automatic IPv6 Address Assignment: Enabled; Enable Automatic DHCP-PD in LAN: Enabled; Autoconfiguration Type: SLAAC+Stateless DHCP; Router Advertisement Lifetime: minutes

A "Save" button is located in the top right corner of the configuration area. The footer of the page reads "COPYRIGHT © 2014 D-Link".

Static IPv6

Select **Static IP** if your IPv6 information is provided by your Internet service provider (ISP).

Use Link-Local Address: Enable or disable a link-local address.

IPv6 Address: If you disabled **Use Link-Local Address**, enter the address supplied by your ISP.

Subnet Prefix Length: If you disabled **Use Link-Local Address**, enter the subnet prefix length supplied by your ISP.

Default Gateway: Enter the default gateway for your IPv6 connection.

Primary DNS Server: Enter the primary DNS server address.

Secondary DNS Server: Enter the secondary DNS server address.

LAN IPv6 Address: Enter the LAN (local) IPv6 address for the router.

LAN IPv6 Link-Local Address: Displays the router's LAN link-local address.

Enable Automatic IPv6 Address Assignment: Check to enable the Automatic IPv6 Address Assignment feature.

The screenshot displays the IPv6 configuration interface for a D-Link DIR-895L router. The page title is 'IPv6' and it includes a navigation menu with 'Home', 'Settings', 'Advanced', and 'Management'. The main content area shows the following settings:

- My Internet Connection is:** Static IPv6 (dropdown menu)
- Use Link-Local Address:** Enabled (toggle)
- Default Gateway:** (text input field)
- Primary DNS Server:** (text input field)
- Secondary DNS Server:** (text input field)

Below these are two sections:

- LAN IPv6 ADDRESS SETTINGS:**
 - LAN IPv6 Address:** (text input field) /64
 - LAN IPv6 Link-Local Address:** Not Available
- ADDRESS AUTOCONFIGURATION SETTINGS:**
 - Enable Automatic IPv6 Address Assignment:** Enabled (toggle)
 - Autoconfiguration Type:** SLAAC+Stateless DHCP (dropdown menu)
 - Router Advertisement Lifetime:** 60 minutes

At the bottom of the page, there is a copyright notice: 'COPYRIGHT © 2014 D-Link'.

Auto Configuration Type: Select **Stateful (DHCPv6)**, **SLAAC + RDNSS** or **SLAAC + Stateless DHCPv6**.

Router Advertisement Lifetime: Enter the IPv6 address lifetime (in minutes).

Click **Save** when you are done.

The screenshot shows the IPv6 configuration interface for a D-Link DIR-895L router. The page title is "IPv6" and it includes a navigation menu with "Home", "Settings", "Advanced", and "Management". The main content area is titled "IPv6" and contains the following settings:

- My Internet Connection is:** Static IPv6 (dropdown menu)
- Use Link-Local Address:** Enabled (checkbox)
- Default Gateway:** (text input field)
- Primary DNS Server:** (text input field)
- Secondary DNS Server:** (text input field)

LAN IPv6 ADDRESS SETTINGS

- LAN IPv6 Address:** (text input field) /64
- LAN IPv6 Link-Local Address:** Not Available
- [Advanced Settings...](#)

ADDRESS AUTOCONFIGURATION SETTINGS

- Enable Automatic IPv6 Address Assignment:** Enabled (checkbox)
- Autoconfiguration Type:** SLAAC+Stateless DHCP (dropdown menu)
- Router Advertisement Lifetime:** 60 minutes (text input field)

At the bottom of the page, there is a "Save" button and a copyright notice: "COPYRIGHT © 2014 D-Link".

Auto Configuration (SLAAC/DHCPv6)

This is a connection method where the ISP assigns your IPv6 address when your router requests one from the ISP's server. Some ISPs require you to make some settings on your side before your router can connect to the IPv6 Internet.

DNS Type: Select either **Obtain DNS server address automatically** or **Use the following DNS address**.

Primary DNS Server: If you selected **Use the following DNS address** above, enter the primary DNS server address.

Secondary DNS Server: If you selected **Use the following DNS address** above, enter the secondary DNS server address.

Enable DHCP-PD: Enable or disable prefix delegation services.

LAN IPv6 Address: If you disabled DHCP-PD, enter the LAN (local) IPv6 address for the router.

LAN IPv6 Link-Local Address: Displays the router's LAN link-local address.

Enable Automatic IPv6 Address Assignment: Enable or disable the Automatic IPv6 Address Assignment feature.

Enable Automatic DHCP-PD in LAN: Enable or disable DHCP-PD for other IPv6 routers connected to the LAN interface.

Note: This feature requires a smaller subnet prefix than /64 (i.e. allowing for a larger address allocation), such as /63. Contact your ISP for more information.

The screenshot displays the IPv6 configuration interface of a D-Link router. At the top, there's a navigation bar with 'Home', 'Settings', 'Advanced', and 'Management' tabs. The main heading is 'IPv6' with a sub-message: 'All of your IPv6 Internet and network connection details are displayed on this page.' Below this, there's a breadcrumb trail 'Settings >> Internet >> IPv6' and a 'Save' button. The 'My Internet Connection is' dropdown menu is set to 'Auto Configuration'. The 'IPv6 DNS SETTINGS' section shows 'DNS Type' set to 'Obtain a DNS server address'. The 'LAN IPv6 ADDRESS SETTINGS' section has 'Enable DHCP-PD' checked. The 'ADDRESS AUTOCONFIGURATION SETTINGS' section has 'Enable Automatic IPv6 Address Assignment' and 'Enable Automatic DHCP-PD in LAN' both checked, and 'Autoconfiguration Type' set to 'SLAAC+Stateless DHCP'. The 'Router Advertisement Lifetime' is set to 0 minutes. A copyright notice 'COPYRIGHT © 2014 D-Link' is at the bottom.

Auto Configuration Type: Select **Stateful (DHCPv6)**, **SLAAC + RDNSS** or **SLAAC + Stateless DHCPv6**

Router Advertisement Lifetime: Enter the IPv6 address lifetime (in minutes).

Click **Save** when you are done.

The screenshot displays the IPv6 configuration page in the D-Link web interface. At the top, the D-Link logo and model information (DIR-895L HW:V1 FW:1.00) are visible, along with navigation links for Home, Settings, Advanced, and Management. The main heading is "IPv6" with a sub-note: "All of your IPv6 Internet and network connection details are displayed on this page." Below this, a breadcrumb trail shows "Settings >> Internet >> IPv6" and a "Save" button. The "My Internet Connection is:" dropdown is set to "Auto Configuration". Under "IPv6 DNS SETTINGS", the "DNS Type:" dropdown is set to "Obtain a DNS server address". The "LAN IPv6 ADDRESS SETTINGS" section shows "Enable DHCP-PD:" as "Enabled" and "LAN IPv6 Link-Local Address:" as "Not Available". The "ADDRESS AUTOCONFIGURATION SETTINGS" section shows "Enable Automatic IPv6 Address Assignment:" as "Enabled", "Enable Automatic DHCP-PD in LAN:" as "Enabled", "Autoconfiguration Type:" set to "SLAAC+Stateless DHCP", and "Router Advertisement Lifetime:" set to a text input field followed by "minutes". A "COPYRIGHT © 2014 D-Link" notice is at the bottom.

PPPoE

Select **PPPoE** if your Internet connection requires you to enter a username and password. This information is provided by your Internet service provider (ISP).

PPPoE Session: Choose **Share with IPv4** to re-use your IPv4 PPPoE username and password, or **Create a new session**.

Username: If you selected **Create a new session** above, enter the PPPoE username provided by your ISP here.

Password: If you selected **Create a new session** above, enter the PPPoE password provided by your ISP here.

Address Mode: Select **Static IP** if your ISP assigned you the IP address, subnet mask, gateway, and DNS server addresses. In most cases, select **Dynamic IP**.

IP Address: Enter the IP address provided by your ISP (Static IP only).

DNS Type: Select either **Obtain DNS server address automatically** or **Use the following DNS address**.

Primary DNS Server: If you selected **Use the following DNS address** above, enter the primary DNS server address.

Secondary DNS Server: If you selected **Use the following DNS address** above, enter the secondary DNS server address.

Enable DHCP-PD: Enable or disable DHCP-PD for other IPv6 routers connected to the LAN interface.

The screenshot displays the IPv6 configuration interface for a D-Link DIR-895L router. The page title is "IPv6" and it includes a navigation menu with "Home", "Settings", "Advanced", and "Management". The main content area shows the following settings:

- My Internet Connection is:** PPPoE
- PPPoE Session:** Share with IPv4
- Address Mode:** Dynamic IP
- IPv6 DNS SETTINGS:** DNS Type: Obtain a DNS server address
- LAN IPv6 ADDRESS SETTINGS:** Enable DHCP-PD: Enabled; LAN IPv6 Link-Local Address: Not Available
- ADDRESS AUTOCONFIGURATION SETTINGS:**
 - Enable Automatic IPv6 Address Assignment: Enabled
 - Enable Automatic DHCP-PD in LAN: Enabled
 - Autoconfiguration Type: SLAAC+Stateless DHCP
 - Router Advertisement Lifetime: 0 minutes

At the bottom of the page, there is a copyright notice: "COPYRIGHT © 2014 D-Link".

Note: This feature requires a smaller subnet prefix than /64 (i.e. allowing for a larger address allocation), such as /63. Contact your ISP for more information.

LAN IPv6 Address: Enter the LAN (local) IPv6 address for the router.

LAN IPv6 Link-Local Address: Displays the router's LAN link-local address.

Enable Automatic IPv6 Address Assignment: Enable or disable the Automatic IPv6 Address Assignment feature.

Enable Automatic DHCP-PD in LAN: Enable or disable DHCP-PD for other IPv6 routers connected to the LAN interface.

Auto Configuration DHCPv6 Type: Select **Stateful (DHCPv6)**, **SLAAC + RDNSS** or **SLAAC + Stateless**

Router Advertisement Lifetime: Enter the IPv6 address lifetime (in minutes).

Click **Save** when you are done.

The screenshot shows the IPv6 configuration interface for a D-Link DIR-895L router. The page is titled 'IPv6' and includes a navigation menu with 'Home', 'Settings', 'Advanced', and 'Management'. The main content area is divided into several sections:

- Settings >> Internet >> IPv6:** A breadcrumb trail with 'IPv4' and 'Save' buttons.
- My Internet Connection is:** A dropdown menu set to 'PPPoE'.
- PPPoE Session:** A dropdown menu set to 'Share with IPv4'.
- Address Mode:** A dropdown menu set to 'Dynamic IP'.
- IPv6 DNS SETTINGS:** A section with 'DNS Type' set to 'Obtain a DNS server address'.
- LAN IPv6 ADDRESS SETTINGS:** A section with 'Enable DHCP-PD' set to 'Enabled' and 'LAN IPv6 Link-Local Address' set to 'Not Available'. A link for 'Advanced Settings...' is present.
- ADDRESS AUTOCONFIGURATION SETTINGS:** A section with 'Enable Automatic IPv6 Address Assignment' and 'Enable Automatic DHCP-PD in LAN' both set to 'Enabled'. 'Autoconfiguration Type' is set to 'SLAAC+Stateless DHCP' and 'Router Advertisement Lifetime' is set to a default value in minutes.

At the bottom of the page, there is a copyright notice: 'COPYRIGHT © 2014 D-Link'.

IPv6 in IPv4 Tunnel

The user can configure the IPv6 connection to run in IPv4 Tunnel mode. IPv6 over IPv4 tunneling encapsulates IPv6 packets in IPv4 packets so that IPv6 packets can be sent over an IPv4 infrastructure.

Remote IPv4 Address: Enter the IPv4 remote address you will use.

Remote IPv6 Address: Enter the IPv6 remote address you will use.

Local IPv4 Address: Enter the IPv4 local address you will use.

Local IPv6 Address: Enter the IPv6 local address you will use.

Subnet Prefix Length: Enter the subnet prefix length supplied by your ISP.

DNS Type: Select either **Obtain DNS server address automatically** or **Use the following DNS address**.

Primary DNS Server: If you selected **Use the following DNS address** above, enter the primary DNS server address.

Secondary DNS Server: If you selected **Use the following DNS address** above, enter the secondary DNS server address.

Enable DHCP-PD: Enable or disable DHCP-PD for other IPv6 routers connected to the LAN interface.

Note: This feature requires a smaller subnet prefix than /64 (i.e. allowing for a larger address allocation), such as /63. Contact your ISP for more information.

The screenshot shows the IPv6 configuration interface for a D-Link DIR-895L router. The page title is "IPv6" and it includes a navigation menu with "Home", "Settings", "Advanced", and "Management". The main content area is titled "IPv6" and contains the following settings:

- My Internet Connection is:** IPv6 in IPv4 tunnel (selected from a dropdown menu)
- Remote IPv4 Address:** (empty text input field)
- Remote IPv6 Address:** (empty text input field)
- Local IPv4 Address:** 172.17.5.158
- Local IPv6 Address:** (empty text input field)
- Subnet Prefix Length:** (empty text input field)

Below these fields are three sections of settings:

- IPv6 DNS SETTINGS:** DNS Type: Obtain a DNS server address (selected from a dropdown menu)
- LAN IPv6 ADDRESS SETTINGS:**
 - Enable DHCP-PD: Enabled (checkbox)
 - LAN IPv6 Link-Local Address: Not Available
- ADDRESS AUTOCONFIGURATION SETTINGS:**
 - Enable Automatic IPv6 Address Assignment: Enabled (checkbox)
 - Enable Automatic DHCP-PD in LAN: Enabled (checkbox)
 - Autoconfiguration Type: SLAAC+Stateless DHCP (selected from a dropdown menu)
 - Router Advertisement Lifetime: 60 minutes

At the bottom right of the page, there is a "Save" button and a "Copyright © 2014 D-Link" notice.

LAN IPv6 Address: If you disabled DHCP-PD, enter the LAN (local) IPv6 address for the router.

LAN IPv6 Link-Local Address: Displays the router's LAN link-local address.

Enable Automatic IPv6 Address Assignment: Enable or disable the Automatic IPv6 Address Assignment feature.

Enable Automatic DHCP-PD in LAN: Enable or disable DHCP-PD for other IPv6 routers connected to the LAN interface.

Note: This feature requires a smaller subnet prefix than /64 (i.e., allowing for a larger address allocation), such as /63. Contact your ISP for more information.

Auto Configuration Type: Select **Stateful (DHCPv6)**, **SLAAC + RDNSS** or **SLAAC + Stateless DHCPv6**

Router Advertisement Lifetime: Enter the IPv6 address lifetime (in minutes).

Click **Save** when you are done.

The screenshot displays the IPv6 configuration interface for a D-Link DIR-895L router. The page is titled "IPv6" and includes a navigation menu with "Home", "Settings", "Advanced", and "Management". The main content area is divided into several sections:

- Internet Connection:** A dropdown menu is set to "IPv6 in IPv4 tunnel". Below it are input fields for "Remote IPv4 Address", "Remote IPv6 Address", "Local IPv4 Address" (pre-filled with "172.17.5.158"), "Local IPv6 Address", and "Subnet Prefix Length".
- IPv6 DNS SETTINGS:** A dropdown menu for "DNS Type" is set to "Obtain a DNS server address".
- LAN IPv6 ADDRESS SETTINGS:** A toggle for "Enable DHCP-PD" is set to "Enabled". The "LAN IPv6 Link-Local Address" is listed as "Not Available".
- ADDRESS AUTOCONFIGURATION SETTINGS:** A toggle for "Enable Automatic IPv6 Address Assignment" is set to "Enabled". A toggle for "Enable Automatic DHCP-PD in LAN" is also set to "Enabled". The "Autoconfiguration Type" dropdown is set to "SLAAC+Stateless DHCP". The "Router Advertisement Lifetime" is set to "60" minutes.

At the bottom right of the configuration area, there is a "Save" button. A copyright notice "COPYRIGHT © 2014 D-Link" is visible at the very bottom of the page.

6 to 4

In this section the user can configure the IPv6 6 to 4 connection settings. 6to4 is an IPv6 address assignment and automatic tunneling technology that is used to provide unicast IPv6 connectivity between IPv6 sites and hosts across the IPv4 Internet.

6 to 4 Address: Displays the 6 to 4 address.

6 to 4 Relay: Enter the 6 to 4 relay supplied by your ISP.

Primary DNS Server: Enter the primary DNS server address.

Secondary DNS Server: Enter the secondary DNS server address.

LAN IPv6 Address: Enter the LAN (local) IPv6 address for the router.

LAN IPv6 Link-Local Address: Displays the router's LAN link-local address.

Enable Automatic IPv6 Address Assignment: Check to enable the Automatic IPv6 Address Assignment feature.

Auto Configuration Type: Select **Stateful (DHCPv6)**, **SLAAC + RDNSS** or **SLAAC + Stateless DHCPv6**.

Router Advertisement Lifetime: Enter the IPv6 address lifetime (in minutes).

Click **Save** when you are done.

The screenshot shows the IPv6 configuration interface for a D-Link DIR-895L router. The page title is "IPv6" and it includes a navigation menu with "Home", "Settings", "Advanced", and "Management". The main content area is titled "IPv6" and contains a sub-header "All of your IPv6 internet and network connection details are displayed on this page." Below this, there is a breadcrumb trail "Settings >> Internet >> IPv6" and a "Save" button. The configuration fields are as follows:

- My Internet Connection is:** A dropdown menu set to "6to4".
- 6to4 Address:** A text field containing "172.17.5.158".
- 6to4 Relay:** A text field containing "192.88.99.1".
- Primary DNS Server:** An empty text field.
- Secondary DNS Server:** An empty text field.

Below these fields is the "LAN IPv6 ADDRESS SETTINGS" section, which includes:

- LAN IPv6 Address:** A text field containing "FFFF:FFFF:FFFF: " followed by a small input box and " ::1 /64".
- LAN IPv6 Link-Local Address:** A text field containing "Not Available".

At the bottom is the "ADDRESS AUTOCONFIGURATION SETTINGS" section, which includes:

- Enable Automatic IPv6 Address Assignment:** A checkbox that is checked and labeled "Enabled".
- Autoconfiguration Type:** A dropdown menu set to "SLAAC+Stateless DHCP".
- Router Advertisement Lifetime:** A text field containing " " followed by "minutes".

The footer of the page contains the text "COPYRIGHT © 2014 D-Link".

6rd

In this section the user can configure the IPv6 6rd connection settings.

Assign IPv6 Prefix: Currently unsupported.

Primary DNS Server: Enter the primary DNS server address.

Secondary DNS Server: Enter the secondary DNS server address.

Enable Hub and Spoke Mode: Enable if you want to minimize the number of routes to the destination by using a hub and spoke method of networking.

6rd Configuration: Choose the **6rd DHCPv4 Option** to automatically discover and populate the data values, or **Manual Configuration** to enter the settings yourself.

6rd IPv6 Prefix: Enter the 6rd IPv6 prefix and mask length supplied by your ISP (manual configuration only).

6rd Border Relay IPv4 Address: Enter the 6rd border relay IPv4 address settings supplied by your ISP (manual configuration only).

LAN IPv6 Address: Enter the LAN (local) IPv6 address for the router.

LAN IPv6 Link-Local Address: Displays the router's LAN link-local address.

D-Link
DIR-895L HW:V1 FW:1.00

Home | Settings | Advanced | Management

IPv6

All of your IPv6 Internet and network connection details are displayed on this page.

Settings >> Internet >> IPv6 IPv4 Save

My Internet Connection is:

Assign IPv6 Prefix:

Primary DNS Server:

Secondary DNS Server:

6RD MANUAL CONFIGURATION

Enable Hub and Spoke Mode:

6rd Configuration:

LAN IPv6 ADDRESS SETTINGS

LAN IPv6 Address: Not Available
LAN IPv6 Link-Local Address: Not Available [Advanced Settings...](#)

ADDRESS AUTOCONFIGURATION SETTINGS

Enable Automatic IPv6 Address Assignment:

Autoconfiguration Type:

Router Advertisement Lifetime: minutes

COPYRIGHT © 2014 D-Link

Enable Automatic IPv6 Address Assignment: Check to enable the Automatic IPv6 Address Assignment feature.

Auto Configuration Type: Select **Stateful (DHCPv6)**, **SLAAC + RDNSS** or **SLAAC + Stateless DHCPv6**

Router Advertisement Lifetime: Enter the IPv6 address lifetime (in minutes).

Click **Save** when you are done.

D-Link
DIR-895L HW:V1 FW:1.00

Home | Settings | Advanced | Management

IPv6

All of your IPv6 Internet and network connection details are displayed on this page.

Settings >> Internet >> IPv6

IPv4 Save

My Internet Connection is: 6rd

Assign IPv6 Prefix:

Primary DNS Server:

Secondary DNS Server:

6RD MANUAL CONFIGURATION

Enable Hub and Spoke Mode:

6rd Configuration: 6rd DHCPv4 Option

LAN IPv6 ADDRESS SETTINGS

LAN IPv6 Address: Not Available

LAN IPv6 Link-Local Address: Not Available

[Advanced Settings...](#)

ADDRESS AUTOCONFIGURATION SETTINGS

Enable Automatic IPv6 Address Assignment:

Autoconfiguration Type: SLAAC+Stateless DHCP

Router Advertisement Lifetime: minutes

COPYRIGHT © 2014 D-Link

Local Connectivity Only

Local Connectivity Only allows you to set up an IPv6 connection that will not connect to the Internet.

Enable ULA: Click here to enable Unique Local IPv6 Unicast Addresses settings.

Use Default ULA Prefix: Checking this box will automatically configure the ULA prefix for the default setting.

ULA Prefix: If you wish to choose your own ULA prefix, enter it here.

Current IPv6 ULA Settings: This section will display the current settings for your IPv6 ULA.

Click **Save** when you are done.

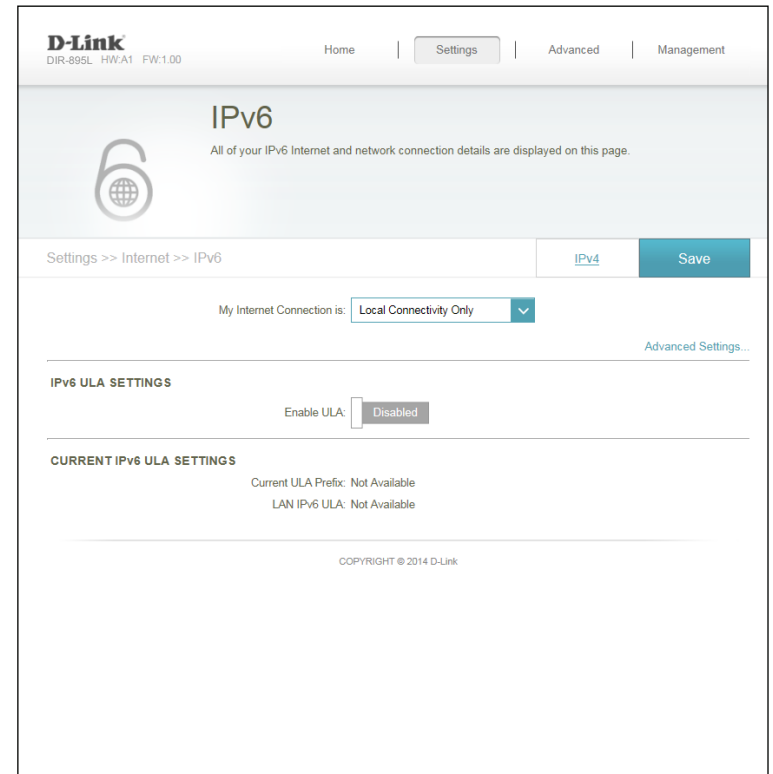

Wireless

In the Settings menu on the bar on the top of the page, click **Wireless** to see the wireless configuration options. To configure the router's guest zone, click the **Guest Zone** link. Refer to page 94 for details. Click **Advanced Settings...** to expand the list and see all of the options. The following options apply to both the 2.4 GHz and the 5 GHz wireless frequency bands:

Smart Connect: Enable this option to have the DIR-895L automatically manage the 2.4 GHz and 5 GHz wireless networks. Disable this option if you want to manually configure the 2.4 GHz and 5 GHz wireless networks.

Status: Enable or disable the wireless frequency band.

Wi-Fi Name (SSID): Create a name for your wireless network using up to 32 characters.

Password: Create a password to use for wireless security. Wireless clients will need to enter this password to successfully connect to the network.

Security Mode: Choose **None**, **WEP**, or **WPA/WPA2-(Personal)** (recommended).

802.11 Mode: Select the desired wireless networking standards to use. The available options will depend on the wireless frequency band, as well as the currently selected security mode.

Wi-Fi Channel: Select the desired channel. The default is **Auto** (recommended).

Transmission Power: Select the desired wireless transmission power.

Channel Width: Select **Auto 20/40** if you are using both 802.11n and non-802.11n wireless devices, or select **20 MHz** if you are not using any 802.11n wireless clients.

The screenshot displays the D-Link wireless configuration interface. At the top, there's a navigation bar with 'Home', 'Settings', 'Advanced', and 'Management'. The main heading is 'Wireless', with a sub-note: 'Use this section to configure the wireless settings for your D-Link Router. Please make sure that any changes made in this section will need to be updated on your wireless device.' Below this, there's a breadcrumb 'Settings >> Wireless' and buttons for 'Guest Zone' and 'Save'. The 'Smart Connect' section has a toggle set to 'Disabled'. The '2.4GHz' section shows a 'Status' toggle set to 'Enabled'. The 'Wi-Fi Name (SSID)' is 'dlink-9000' and the 'Password' is '1234567890'. An 'Advanced Settings...' link is present. A list of settings includes: Security Mode (WPA/WPA2-Personal), 802.11 Mode (Mixed 802.11b/g/n), Wi-Fi Channel (Auto), Transmission Power (High), Channel Width (Auto 20/40 MHz), and Visibility Status (Visible). At the bottom, the 'Schedule' is set to 'Always Enable'.

Visibility Status: The default setting is **Visible**. Select **Invisible** if you do not want to broadcast the SSID of your wireless network.

Schedule: Use the drop-down menu to select the time schedule that the rule will be enabled on. The schedule may be set to **Always Enable**, or you can create your own schedules in the **Schedules** section (refer to page 112).

Click **Save** when you are done.

The screenshot displays the configuration interface for the Primary and Secondary 5GHz Wi-Fi networks. The Primary 5GHz section is at the top, and the Secondary 5GHz section is below it. Both sections have a Status dropdown set to 'Enabled'. The Primary 5GHz section has a Wi-Fi Name (SSID) of 'dlink-9000-5GHz-lo' and a Password of '1234567890'. The Secondary 5GHz section has a Wi-Fi Name (SSID) of 'dlink-9000-5GHz-hi' and a Password of '1234567890'. Both sections have a Security Mode of 'WPA/WPA2-Personal', an 802.11 Mode of 'Mixed 802.11a/n/ac', a Wi-Fi Channel of 'Auto' (for Primary) or '149' (for Secondary), a Transmission Power of 'High', a Channel Width of 'Auto 20/40/80 MHz', a Visibility Status of 'Visible', and a Schedule of 'Always Enable'. There are 'Advanced Settings...' links at the end of each section.

Setting	Primary 5GHz	Secondary 5GHz
Status	Enabled	Enabled
Wi-Fi Name (SSID)	dlink-9000-5GHz-lo	dlink-9000-5GHz-hi
Password	1234567890	1234567890
Security Mode	WPA/WPA2-Personal	WPA/WPA2-Personal
802.11 Mode	Mixed 802.11a/n/ac	Mixed 802.11a/n/ac
Wi-Fi Channel	Auto	149
Transmission Power	High	High
Channel Width	Auto 20/40/80 MHz	Auto 20/40/80 MHz
Visibility Status	Visible	Visible
Schedule	Always Enable	Always Enable

Guest Zone

The guest zone feature will allow you to create temporary zones that can be used by guests to access the Internet. These zones will be separate from your main wireless network. You may configure different zones for the 2.4 GHz and 5 GHz wireless bands.

In the Settings menu on the bar on the top of the page, click **Wireless**, then click the **Guest Zone** link. Click **Advanced Settings...** to expand the list and see all of the options. The following options apply to both the 2.4 GHz and the 5 GHz wireless frequency bands:

Status: Enable or disable the guest zone for each wireless frequency band.

Wi-Fi Name (SSID): Enter a wireless network name (SSID) that is different from your main wireless network.

Password: Create a password to use for wireless security. Wireless clients will need to enter this password to successfully connect to the guest zone.

Internet Access Only: Enabling this option will confine connectivity to the Internet, disallowing guests from accessing other local network devices.

Click **Save** when you are done.

D-Link
DIR-895L HW:A1 FW:1.00

Home | Settings | Features | Management

Guest Zone

This page lets you enable and configure a Wi-Fi Guest Zone. Users connected to a Guest Zone cannot communicate or detect devices on your home network unless Internet Access Only is disabled under Home Network Access.

Settings >> Wireless >> Guest Zone [Wi-Fi](#) [Save](#)

2.4GHz

Status:

Wi-Fi Name (SSID):

Password:

Primary 5GHz

Status:

Wi-Fi Name (SSID):

Password:

Secondary 5GHz

Status:

Wi-Fi Name (SSID):

Password:

Home Network Access

Internet Access Only:

COPYRIGHT © 2014 D-Link

Network

This section will allow you to change the local network settings of the router and to configure the DHCP settings. In the Settings menu on the bar on the top of the page, click **Network**. Click **Advanced Settings...** to expand the list and see all of the options.

LAN IP Address: Enter the IP address of the router. The default IP address is **192.168.0.1**.

If you change the IP address, once you click **Save**, you will need to enter the new IP address in your browser to get back into the configuration utility.

Subnet Mask: Enter the subnet mask of the router. The default subnet mask is **255.255.255.0**.

Management Link: The default address to access the router's configuration is **http://dlinkrouter.local/**. Here, you can replace **dlinkrouter** with a name of your choice.

Local Domain Name: Enter the domain name (optional).

Enable DNS Relay: Disable to transfer the DNS server information from your ISP to your computers. If enabled, your computers will use the router for a DNS server.

Status: Enable or disable the DHCP server.

DHCP IP Address Range: Enter the starting and ending IP addresses for the DHCP server's IP assignment.

Note: If you statically (manually) assign IP addresses to your computers or devices, make sure the IP addresses are outside of this range or you may have an IP conflict.

The screenshot displays the D-Link router's configuration interface for the Network section. At the top, there are navigation tabs for Home, Settings, Advanced, and Management. The main heading is 'Network', with a sub-heading 'Use this section to configure the network settings for your device. You can enter a name for your device in the management link field, and use the link to access web UI in a web browser. We recommend you change the management link if there are more than one D-Link devices within the network.' Below this, there are two 'Save' buttons. The 'Network Settings' section includes: LAN IP Address (192.168.0.1), Subnet Mask (255.255.255.0), Management Link (http://dlinkrouter.local/), Local Domain Name, and Enable DNS Relay (Enabled). An 'Advanced Settings...' link is present. The 'DHCP Server' section includes: Status (Disabled), DHCP IP Address Range (192.168.0.1 to 192.168.0.254), DHCP Lease Time (10000 minutes), and Always Broadcast (Disabled). The 'Advanced Settings' section includes: WAN Port Speed (Auto), UPnP (Enabled), IPv4 Multicast Streams (Disabled), and IPv6 Multicast Streams (Disabled). A copyright notice 'COPYRIGHT © 2014 D-Link' is at the bottom.

DHCP Lease Time: Enter the length of time for the IP address lease in minutes.

Always Broadcast: Enable this feature to broadcast your networks DHCP server to LAN/WLAN clients.

UPnP: Enable or disable Universal Plug and Play (UPnP). UPnP provides compatibility with networking equipment, software and peripherals.

WAN Port Speed: You may set the port speed of the Internet port to 10 Mbps, 100 Mbps, 1000 Mbps, or Auto (recommended).

IPv4 Multicast Stream: Enable to allow IPv4 multicast traffic to pass through the router from the Internet.

IPv6 Multicast Stream: Enable to allow IPv6 multicast traffic to pass through the router from the Internet.

Click **Save** when you are done.

The screenshot shows the D-Link web interface for the DIR-895L HW:V1 FW:1.00. The page is titled "Network" and includes a navigation menu with "Home", "Settings", "Advanced", and "Management". Below the title is a brief instruction: "Use this section to configure the network settings for your device. You can enter a name for your device in the management link field, and use the link to access web UI in a web browser. We recommend you change the management link if there are more than one D-Link devices within the network." The interface is divided into several sections:

- Network Settings:** Contains fields for LAN IP Address (192.168.0.1), Subnet Mask (255.255.255.0), Management Link (http://dlinkrouter.local/), Local Domain Name, and an "Enable DNS Relay" checkbox which is checked.
- DHCP Server:** Contains a "Status" dropdown set to "Disabled", a "DHCP IP Address Range" field showing 192.168.0.1 to 192.168.0.254, a "DHCP Lease Time" field set to 10080 minutes, and an "Always Broadcast" checkbox which is checked.
- Advanced Settings:** Contains a "WAN Port Speed" dropdown set to "Auto", a "UPnP" checkbox which is checked, and two "Multicast Streams" checkboxes (IPv4 and IPv6) which are both disabled.

At the bottom of the page, there is a "COPYRIGHT © 2014 D-Link" notice.

SharePort

This page will allow you to set up access to files on an external USB device plugged into the router. You can do this through the local network or from the Internet using either a web browser or an app on your smartphone or tablet. In the Settings menu on the bar on the top of the page, click **SharePort**.

Status: Check to enable DLNA media server functions, allowing connected clients access to media files over the network.

DLNA Media Server: Choose a name for your DLNA media server so that it can be found.

Windows File Sharing (SAMBA): Choose either **Allow all users to access (no password)** or **Require router's admin password** to specify whether the router's password will be required for access.

Web File Access: Enable remote access to files stored on a USB device plugged into the router through a web browser.

Direct Links: This area will display the HTTP and HTTPS links to connect to your SharePort drive through a web browser from a device on your network.

Note: You may only use these link in local network.

Click **Save** when you are done.

To manage user accounts for SharePort access, click **Create User** and refer to the next page for details.

The screenshot shows the D-Link SharePort configuration interface. At the top, there's a navigation bar with 'Home', 'Settings', 'Advanced', and 'Management'. The main heading is 'SharePort' with a brief description: 'SharePort allows you to share photos, music, movies and files simply by connecting a USB drive to your router. Access your files locally and remotely using the free mylink SharePort app for your iOS or Android devices, or access them on a computer through the SharePort Web Access. The built-in Digital Living Network Alliance (DLNA) media server allows you to stream multimedia content to any DLNA compliant devices such as smart TVs and games consoles.'

Below the heading, there are three sections:

- DLNA Media Server:** Status is 'Disabled'. The DLNA Media Server name is 'DIR-895L_DMS'.
- Windows File Sharing (SAMBA):** Status is 'Enabled'. The Windows File Sharing option is set to 'Require router's admin password'.
- Web File Access:** Status is 'Enabled'. Direct Links are 'http://shareport.local/' and 'https://shareport.local/'.

At the bottom, there is a 'COPYRIGHT © 2014 D-Link' notice.

Create User

The Create User page allows you to manage your SharePort user accounts. The current list of user accounts will be displayed, along with their current permissions and access path. If they do not have an account set up, users will be restricted to guest access; only having access to the “Guest” folder on the media server. The router can store a maximum of ten accounts (including the “Admin” account).

If you wish to remove an account, click on its trash can icon in the Delete column. If you wish to edit an account, click on its pencil icon in the Edit column. If you wish to create a new account, click the **Create User** button. If you edit or create a user, the following options will appear:

User Name: Enter the desired user name for the new account.

Password: Enter the password which the user will need to enter when logging in.

Permission: Select either **Read Only** or **Read/Write** to control whether the user can edit, add, or delete files on the device.

Folder: Choose the parent folder that the user will be able to access. Files and folders on a higher level will be unavailable. “root” means that the user can access all files on the device. To change the selected folder, click **Browse** and browse to the desired folder.

Click **OK** when you are done. The new user should be added to the list of user accounts. To save the new list, click **Save**. To return to the SharePort page, click **SharePort**.

D-Link
DIR-895L HW:A1 FW:1.00

Home | Settings | Advanced | Management

SharePort

“Create User” allows you to manage access to your storage devices. After plugging in a USB drive, the new device will appear in the list with a link to it. You can then use this link to connect the drive and login with a user account. Click here for help.

Settings >> SharePort >> Create User

User Name	Access Path	Permission	Edit	Delete
Admin	root	Read/Write	--	--

Create User Remaining: 9

USB Port: Not Available

COPYRIGHT © 2014 D-Link

Create New User

User Name:

Password:

Permission: Read Only

Folder:

mydlink

Enabling mydlink will allow you to access and manage the mydlink-compatible devices on your network. This can be done either through a web browser or via a smartphone app.

This page allows you to sign in to an existing mydlink account, or sign up for a new mydlink account. In the Settings menu on the bar on the top of the page, click **mydlink**.

If you do not already have a mydlink account, click **No, I want to create a new mydlink account**. Fill out your email address (which will also function as your username), choose a password, and enter your first and last name. Then, click **Sign Up** to create your new mydlink account.

If you already have a mydlink account, click **Yes, I have a mydlink account**. Enter your email address (which is also your username) and your password. Then, click **Sign In** to register your existing mydlink account with your router.

The screenshot shows the mydlink registration page. At the top, there is a navigation bar with 'D-Link' on the left and 'Home', 'Settings', 'Advanced', and 'Management' on the right. Below the navigation bar is a header section with the mydlink logo and a description: 'Creating a mydlink account and registering your router with mydlink will allow you to remotely monitor and manage your network on your smartphone or tablet, as well as through the secure web portal. It also allows you to plug in a USB drive and access the stored files from anywhere in the world through iOS and Android apps as well as the web browser on your computer. [Click here for help.](#)' Below the header is a breadcrumb trail 'Settings >> mydlink' and a blue 'Sign Up' button. The main content area is titled 'mydlink Registration' and contains the following form elements: 'Do you have an existing mydlink account?' with two radio buttons: 'Yes, I have a mydlink account.' (unselected) and 'No, I want to create a new mydlink account.' (selected). Below this are four text input fields: 'E-mail Address (Account Name):', 'Password:', 'First Name:', and 'Last Name:'. At the bottom of the form is a checkbox labeled 'I accept the mydlink [terms and conditions.](#)' and a copyright notice 'COPYRIGHT © 2013 D-Link'.

The screenshot shows the mydlink registration page, similar to the one above, but with the 'Sign In' button highlighted. The radio button for 'Yes, I have a mydlink account.' is now selected, and the 'Sign In' button is highlighted in blue. The 'E-mail Address (Account Name):' and 'Password:' fields are visible, while the 'First Name:' and 'Last Name:' fields are not. The rest of the page layout, including the navigation bar, header, and footer, remains the same.

Features

QoS Engine

This section will allow you to prioritize particular clients over others, so that those clients receive higher bandwidth. For example, if one client is streaming a movie and another is downloading a non-urgent file, you might wish to assign the former device a higher priority than the latter so that the movie streaming is not disrupted by the traffic of the other devices on the network.

In the Features menu on the bar on the top of the page, click **QoS Engine**.

Under All Devices, you will see device cards representing each connected client. If some are off-screen, you can use the < and > buttons to scroll through the cards.

A maximum of **one** device can be assigned **Highest** priority.

A maximum of **two** devices can be assigned **High** priority.

A maximum of **eight** devices can be assigned **Medium** priority.

If no devices are explicitly assigned a priority, they will all be treated with equal priority. If some devices are not assigned a priority and others are, the unassigned devices will be treated with the lowest priority.

To assign a priority level to a device, drag the device card from the All Devices list over an empty slot and release the mouse button. The card will remain in the slot. If you want to remove a priority assignment from a device and return it to the All Devices list, click the cross icon in the top right of the device card.

Click **Save** when you are done.

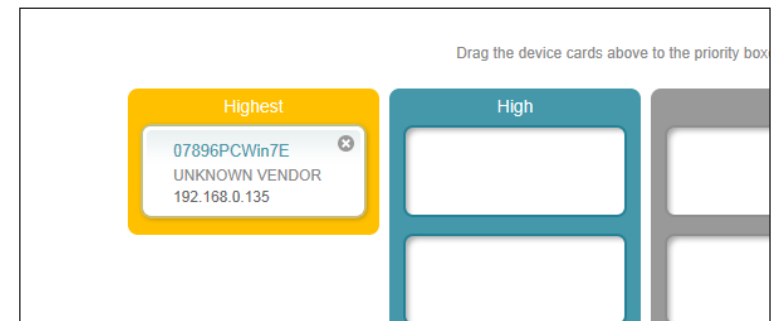
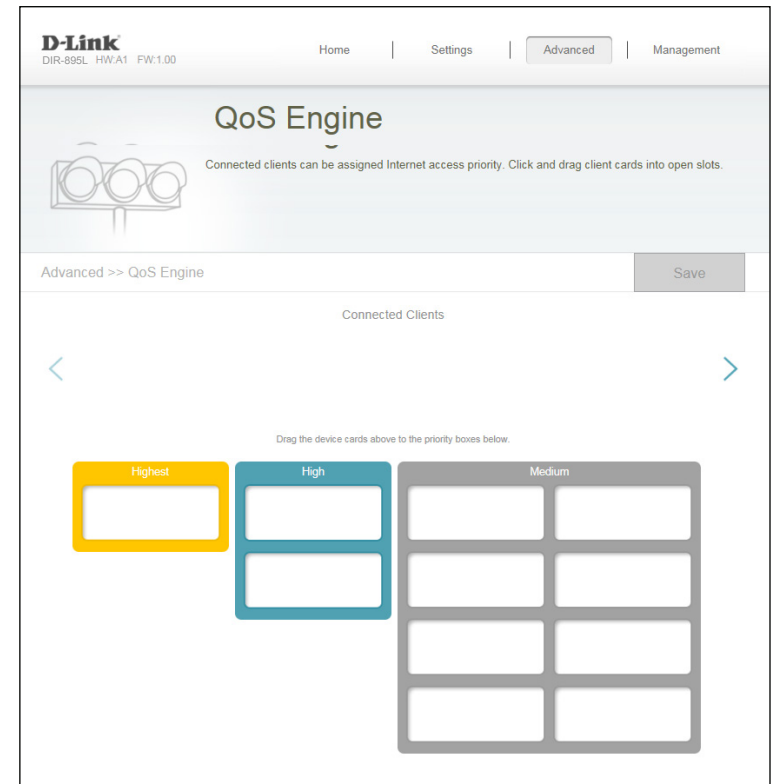

Firewall Settings

The router's firewall protects your network from malicious attacks over the Internet.

Enable DMZ: Enable or disable Demilitarized Zone (DMZ). This completely exposes the client to threats over the Internet, and is not recommended in ordinary situations.

DMZ IP Address: If you enabled DMZ, enter the IP address of the client you wish to expose, or use the drop-down menu to quickly select it.

Enable SPI IPv4: Enabling Stateful Packet Inspection (SPI) helps to prevent cyber attacks by validating that the traffic passing through the session conforms to the protocol.

Enable Anti-Spoof Checking: Enable this feature to protect your network from certain kinds of "spoofing" attacks.

IPv6 Simple Security: Enable or disable IPv6 simple security.

IPv6 Ingress Filtering: Enable or disable IPv6 ingress filtering.

PPTP: Allows multiple machines on the LAN to connect to their corporate network using the PPTP protocol.

The screenshot displays the D-Link Firewall Settings interface. At the top, there is a navigation bar with 'Home', 'Settings', 'Advanced', and 'Management' tabs. The main heading is 'Firewall Settings' with a sub-description: 'Your router's high-performance firewall feature continuously monitors Internet traffic, protecting your network and connected devices from malicious Internet attacks.' Below this, there are tabs for 'IPv4 Rules' and 'IPv6 Rules', and a 'Save' button. The settings are organized into sections:

- Advanced >> Firewall Settings >> Advanced:**
 - Enable DMZ: Disabled
 - Enable SPI IPv4: Disabled
 - Enable Anti-spoof Checking: Disabled
 - IPv6 Simple Security: Disabled
 - IPv6 Ingress Filtering: Disabled
- Application Level Gateway (ALG) Configuration:**
 - PPTP: Enabled
 - IPSec (VPN): Enabled
 - RTSP: Enabled
 - SIP: Enabled

At the bottom right, there is a link for 'Advanced Settings...' and a copyright notice: 'COPYRIGHT © 2014 D-Link'.

IPSec (VPN): Allows multiple VPN clients to connect to their corporate network using IPSec. Some VPN clients support traversal of IPSec through NAT. This Application Level Gateway (ALG) may interfere with the operation of such VPN clients. If you are having trouble connecting with your corporate network, try turning this ALG off.

RTSP: Allows applications that uses Real Time Streaming Protocol (RTSP) to receive streaming media from the Internet.

SIP: Allows devices and applications using VoIP (Voice over IP) to communicate across NAT. Some VoIP applications and devices have the ability to discover NAT devices and work around them. This ALG may interfere with the operation of such devices. If you are having trouble making VoIP calls, try turning this ALG off.

Click **Save** when you are done.

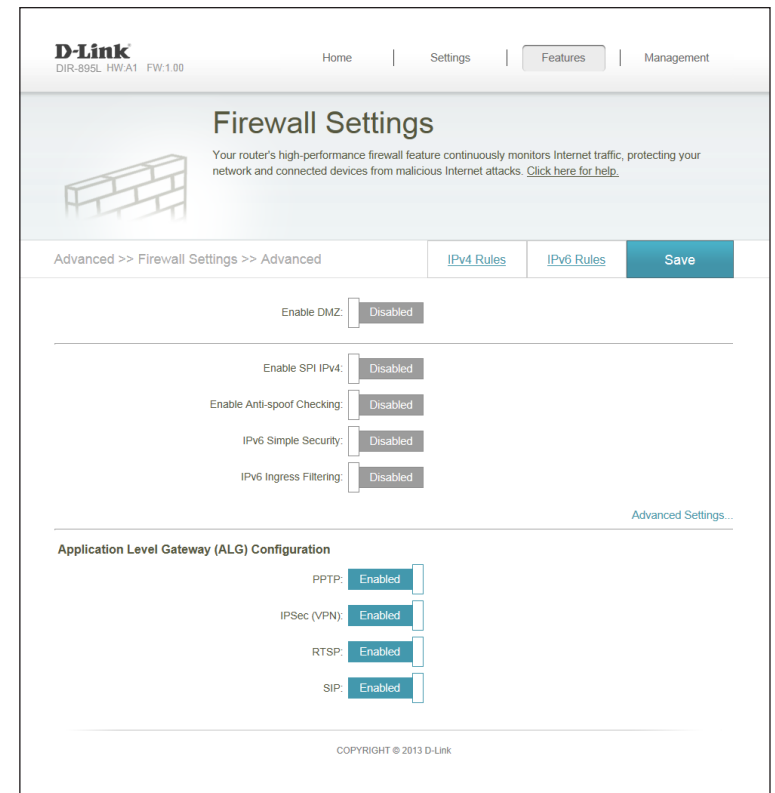

D-Link
DIR-895L HW:V1 FW:1.00

Home | Settings | Features | Management

Firewall Settings

Your router's high-performance firewall feature continuously monitors Internet traffic, protecting your network and connected devices from malicious Internet attacks. [Click here for help.](#)

Advanced >> Firewall Settings >> Advanced [IPv4 Rules](#) [IPv6 Rules](#) **Save**

Enable DMZ: Disabled

Enable SPI IPv4: Disabled

Enable Anti-spoof Checking: Disabled

IPv6 Simple Security: Disabled

IPv6 Ingress Filtering: Disabled

[Advanced Settings...](#)

Application Level Gateway (ALG) Configuration

PPTP: Enabled

IPSec (VPN): Enabled

RTSP: Enabled

SIP: Enabled

COPYRIGHT © 2013 D-Link

IPv4/IPv6 Rules

The IPv4/IPv6 Rules section is an advanced option that lets you configure what kind of traffic is allowed to pass through the network. To configure the IPv4 rules, from the Firewall Settings page click **IPv4 Rules**. To configure IPv6 rules, from the Firewall Settings page click **IPv6 Rules**. To return to the main Firewall Settings page, click **Security Check**.

To begin, use the drop-down menu to select whether you want to **ALLOW** or **DENY** the rules you create. You can also choose to turn filtering **OFF**.

If you wish to remove a rule, click on its trash can icon in the Delete column. If you wish to edit a rule, click on its pencil icon in the Edit column. If you wish to create a new rule, click the **Add Rules** button. Click **Save** when you are done. If you edit or create a rule, the following options will appear:

Name: Enter a name for the rule.

Source IP Address Range: Enter the source IP address range that the rule will apply to, and using the drop-down menu, specify whether it is a **WAN** or **LAN** IP address.

Destination IP Address Range: Enter the destination IP address range that the rule will apply to, and using the drop-down menu, specify whether it is a **WAN** or **LAN** IP address.

Port Range: Select the protocol of the traffic to allow or deny (**Any**, **TCP**, or **UDP**) and then enter the range of ports that the rule will apply to.

Schedule: Use the drop-down menu to select the time schedule that the rule will be enabled on. The schedule may be set to **Always Enable**, or you can create your own schedules in the **Schedules** section (refer to page 112).

Click **OK** when you are done.

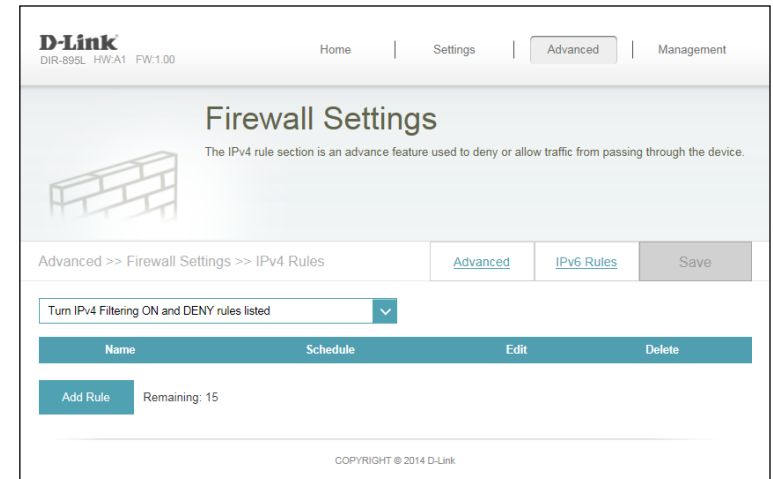

Port Forwarding

Port forwarding allows you to specify a port or range of ports to open for specific devices on the network. This might be necessary for certain applications to connect through the router. In the Features menu on the bar on the top of the page, click **Port Forwarding**.

If you wish to remove a rule, click on its trash can icon in the Delete column. If you wish to edit a rule, click on its pencil icon in the Edit column. If you wish to create a new rule, click the **Add Rules** button. Click **Save** when you are done. If you edit or create a rule, the following options will appear:

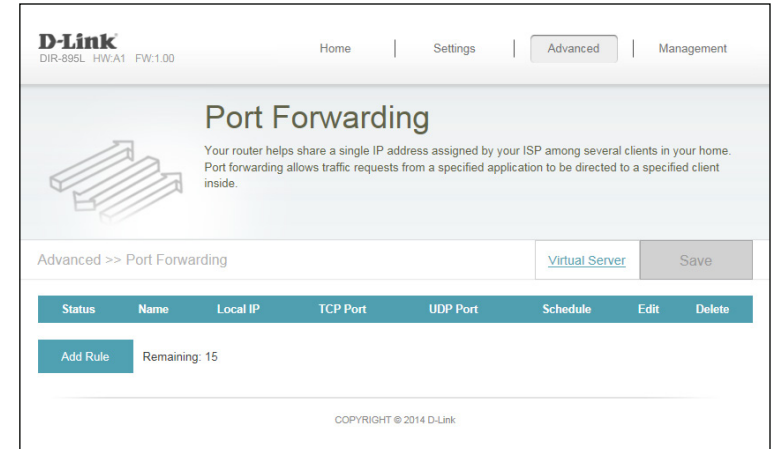

Name: Enter a name for the rule.

Local IP: Enter the IP address of the computer on your local network that you want to allow the incoming service to. Alternatively, select the device from the drop-down menu.

TCP Port: Enter the TCP ports that you want to open. You can enter a single port or a range of ports. Separate ports with a comma (for example: 24,1009,3000-4000).

UDP Port: Enter the UDP ports that you want to open. You can enter a single port or a range of ports. Separate ports with a comma (for example: 24,1009,3000-4000).

Schedule: Use the drop-down menu to select the time schedule that the rule will be enabled on. The schedule may be set to **Always Enable**, or you can create your own schedules in the **Schedules** section (refer to page 112).

Click **OK** when you are done.

Virtual Server

The virtual server allows you to specify a single public port on your router for redirection to an internal LAN IP Address and Private LAN port. To configure the virtual server, from the Port Forwarding page click **Virtual Server**. To return to the main Port Forwarding page, click **Port Forwarding**.

If you wish to remove a rule, click on its trash can icon in the Delete column. If you wish to edit a rule, click on its pencil icon in the Edit column. If you wish to create a new rule, click the **Add Rules** button. Click **Save** when you are done. If you edit or create a rule, the following options will appear:

Name: Enter a name for the rule.

Local IP: Enter the IP address of the computer on your local network that you want to allow the incoming service to. Alternatively, select the device from the drop-down menu.

Protocol: Select the protocol of the traffic to allow or deny (**TCP**, **UDP**, **Both**, or **Other**).

Protocol Number: If you entered **Other** above, enter the protocol number.

External Port: Enter the public port you want to open.

Internal Port: Enter the private port you want to open.

Schedule: Use the drop-down menu to select the time schedule that the rule will be enabled on. The schedule may be set to **Always Enable**, or you can create your own schedules in the **Schedules** section (refer to page 112).

Click **OK** when you are done.

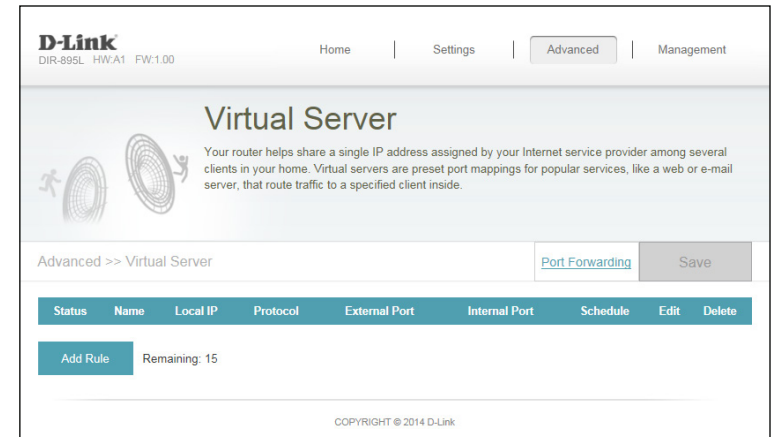

Website Filter

The website filter settings allow you to block access to certain web sites. You can either create a list of sites to block, or create a list of sites to allow (with all other sites being blocked).

In the Features menu on the bar on the top of the page, click **Website Filter**.

If you want to create a list of sites to block, select **DENY computers access to ONLY these sites** from the drop-down menu. All other sites will be accessible. If you want to specify a list of sites to allow, select **ALLOW computers access to ONLY these sites** from the drop-down menu. All other sites will be blocked.

You may specify a maximum of fifteen web sites. To add a new site to the list, click **Create New Rule**. Next, under Website URL/Domain enter the URL or domain. If you wish to remove a rule, click on its trash can icon in the Delete column. If you wish to edit a rule, simply replace the URL or domain.

Click **Save** when you are done.

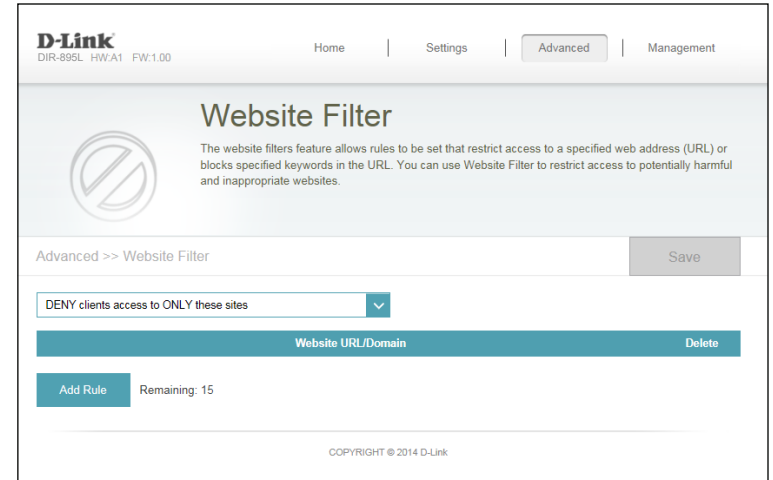

Static Routes

The Static Routes section allows you to define custom routes to control how data traffic is moved around your network.

In the Features menu on the bar on the top of the page, click **Static Routes**. To configure IPv6 rules, click **IPv6** and refer to page 108. To return to the main IPv4 static routes page, click **IPv4**.

If you wish to remove a rule, click on its trash can icon in the Delete column. If you wish to edit a rule, click on its pencil icon in the Edit column. If you wish to create a new rule, click the **Add Rules** button. Click **Save** when you are done. If you edit or create a rule, the following options will appear:

Name: Enter a name for the rule.

Destination IP: Enter the IP address of packets that will take this route.

Netmask: Enter the netmask of the route.

Gateway: Enter your next hop gateway to be taken if this route is used.

Metric: The route metric is a value from 1 to 16 that indicates the cost of using this route. A value 1 is the lowest cost and 15 is the highest cost.

Interface: Select the interface that the IP packet must use to transit out of the router when this route is used.

Click **OK** when you are done.

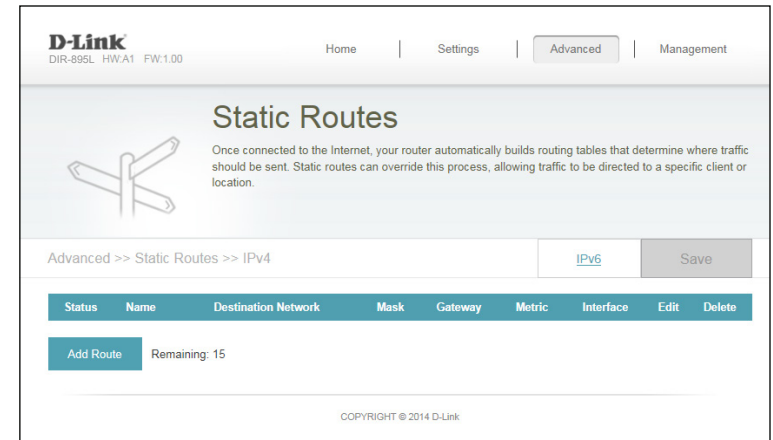

IPv6

To configure IPv6 rules, on the Static Routes page click **IPv6**. To return to the main IPv4 static routes page, click **IPv4**.

If you wish to remove a rule, click on its trash can icon in the Delete column. If you wish to edit a rule, click on its pencil icon in the Edit column. If you wish to create a new rule, click the **Add Rules** button. Click **Save** when you are done. If you edit or create a rule, the following options will appear:

Name: Enter a name for the rule.

DestNetwork: This is the IP address of the router used to reach the specified destination.

PrefixLen: Enter the IPv6 address prefix length of the packets that will take this route.

Metric: Enter the metric value for this rule here.

Interface: Select the interface that the IP packet must use to transit out of the router when this route is used.

Click **OK** when you are done.

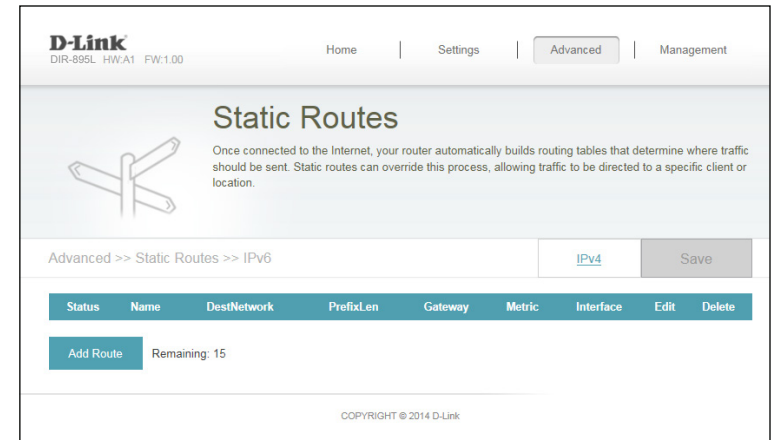

Create New Route ✕

Name:

DestNetwork:

PrefixLen:

Gateway:

Metric:

Interface: ▼

Dynamic DNS

Most Internet service providers (ISPs) assign dynamic (changing) IP addresses. Using a dynamic DNS service provider, people can enter your domain name in their web browser to connect to your server no matter what your IP address is.

In the Features menu on the bar on the top of the page, click **Dynamic DNS**.

Enable Dynamic DNS: Enabling dynamic DNS will reveal further configuration options.

Status: Displays the current dynamic DNS connection status.

Server Address: Enter the address of your dynamic DNS server, or select one from the drop-down menu.

Host Name: Enter the host name that you registered with your dynamic DNS service provider.

User Name: Enter your dynamic DNS username.

Password: Enter your dynamic DNS password.

Time Out: Enter a timeout time (in hours).

Click **Save** when you are done.

At the bottom of the page are the IPv6 host settings. To configure an IPv6 dynamic DNS host, refer to page 110.

D-Link
DIR-895L HW:A1 FW:1.00

Home | Settings | **Advanced** | Management

Dynamic DNS

Dynamic Domain Name Service allows your router to associate an easy-to-remember domain name such as [YourDomainName].com with the regularly changing IP address assigned by your Internet Service provider. This feature is helpful when running a virtual server.

Advanced >> Dynamic DNS Save

Enable Dynamic DNS: Enabled

Status: Disconnected

Server Address: ▼

Host Name:

User Name:

Password:

Time Out: hours

Status	Host Name	IPv6 Address	Edit	Delete
<input type="button" value="Add Record"/>	Remaining: 10			

COPYRIGHT © 2014 D-Link

IPv6 Host

The IPv6 host settings are found at the bottom of the Dynamic DNS page.

If you wish to remove a rule, click on its trash can icon in the Delete column. If you wish to edit a rule, click on its pencil icon in the Edit column. If you wish to create a new rule, click the **Add Rules** button. Click **Save** when you are done. If you edit or create a rule, the following options will appear:

Host Name: Enter the host name that you registered with your dynamic DNS service provider.

IPv6 Address: Enter the IPv6 address of the dynamic DNS server. Alternatively, select the server device in the drop-down menu.

Click **OK** when you are done.

Status	Host Name	IPv6 Address	Edit	Delete
Add Record	Remaining: 10			

COPYRIGHT © 2013 D-Link

Create New Record

Host Name:

IPv6 Address: << Computer Name

Management

Time & Schedule

Time

The Time page allows you to configure, update, and maintain the correct time on the internal system clock. From here you can set the time zone, the Network Time Protocol (NTP) server, and enable or disable daylight saving time.

In the Management menu on the bar on the top of the page, click **Time & Schedule**.

Time Zone: Select your time zone from the drop-down menu.

Time: Displays the current date and time of the router.

Daylight Saving: Enable or disable daylight saving time.

Update Time Using an NTP Server: Enable or disable to allow an NTP server on the Internet to synchronize the time and date with your router. If you enable this option, select an NTP server from the drop-down menu. To configure the router's time and date manually, disable this option and use the drop-down menus that appear to input the time and date.

Click **Save** when you are done.

To configure and manage your schedules, click **Schedule** and refer to page 112.

The screenshot displays the D-Link router's web interface for the 'Time' configuration page. At the top, the D-Link logo and model information (DIR-895L HW:A1 FW:1.00) are visible, along with navigation links for Home, Settings, Advanced, and Management. The page title is 'Time', and a sub-header indicates 'Management >> System Time'. A 'Schedule' button is highlighted in blue, and a 'Save' button is in grey. The 'Time Configuration' section includes a 'Time Zone' dropdown menu set to '(GMT+08:00) Taipei', a 'Time' display showing '2014/10/29 04:22:12 PM', and an 'Enable Daylight Saving' toggle set to 'Disabled'. The 'Automatic Time Configuration' section shows 'Update Time Using an NTP Server' set to 'Enabled' and 'NTP Server' set to 'D-Link NTP Server'. A copyright notice 'COPYRIGHT © 2014 D-Link' is at the bottom.

Schedule

Some configuration rules can be set according to a pre-configured schedule. To create, edit, or delete schedules, from the Time page click **Schedule**. To return to the Time page, click **Time**.

If you wish to remove a rule, click on its trash can icon in the Delete column. If you wish to edit a rule, click on its pencil icon in the Edit column. If you wish to create a new rule, click the **Add Rules** button. Click **Save** when you are done. If you edit or create a rule, the following screen will appear:

First, enter the name of your schedule in the **Name** field.

Each box represents one hour, with the time at the top of each column. To add a time period to the schedule, simply click on the start hour and drag to the end hour. You can add multiple days to the schedule, but only one period per day.

To remove a time period from the schedule, click on the cross icon.

Click **OK** when you are done.

D-Link
DIR-895L HW:A1 FW:1.00

Home | Settings | Advanced | Management

Schedule

Some features, such as the firewall and website filters, can be turned on or off based on a schedule. One common use of schedules is to control access to the Internet by a specified device during specified time periods.

Management >> Schedule

Time Save

Name	Schedule	Edit	Delete
test	Mon : 5:00 - 17:00 Tue : 5:00 - 17:00 Wed : 5:00 - 17:00 Thu : 5:00 - 17:00 Fri : 5:00 - 17:00		

Add Rule Remaining: 9

COPYRIGHT © 2014 D-Link

Name:

	0	1	2	3	4	5	6	7	8	9	10	11	12	13	14	15	16	17	18	19	20	21	22	23
Mon																								
Tue																								
Wed																								
Thu																								
Fri																								
Sat																								
Sun																								

Apply

Name:

	0	1	2	3	4	5	6	7	8	9	10	11	12	13	14	15	16	17	18	19	20	21	22	23
Mon									8:00 - 19:00															
Tue									8:00 - 19:00															
Wed									8:00 - 19:00															
Thu									8:00 - 19:00															
Fri									8:00 - 18:00															
Sat																								
Sun																								

Apply

System Log

The router keeps a running log of events. This log can be sent to a Syslog server, and sent to your email address. In the Management menu on the bar on the top of the page, click **System Log**.

Enable Logging to Syslog Server: Check this box to send the router logs to a SysLog Server. If this is disabled, there will be no other options on this page.

Syslog Server IP Address: Enter the IP address for the Syslog server. If the Syslog server is connected to the router, select it from the drop-down menu to automatically populate the field.

Enable Email Notification: If you want the logs to be automatically sent to an email address, enable this option.

Enter the settings for your email account. These are obtained from your email service provider.

On Log Full: If email notification is enabled, this option will set the router to send the log by email when the log is fully.

On Schedule: This option can be enabled to send an email according to a pre-configured schedule. See below.

Schedule: If you enable **On Schedule** is enabled, use the drop-down menu to select the time schedule that the rule will be enabled on. The schedule may be set to **Always Enable**, or you can create your own schedules in the **Schedules** section (refer to page 112).

Click **Save** when you are done.

The screenshot shows the D-Link System Log configuration interface. At the top, there is a navigation bar with 'Home', 'Settings', 'Advanced', and 'Management' (selected). The main heading is 'System Log' with a sub-heading 'On-board diagnostics run continually in the background to monitor the health of your router. The results are recorded in the system log if it is enabled. This info can be used to diagnose common problems or help Customer Support resolve issues more quickly.' Below this, there is a 'Management >> System Log' breadcrumb and a 'Save' button. The configuration is divided into three sections: 'SysLog Settings', 'E-mail Settings', and 'E-mail Log When Full or On Schedule'. In 'SysLog Settings', 'Enable Logging to Syslog Server' is 'Enabled', and 'SysLog Server IP Address' is an empty field with a dropdown menu showing '<< Computer Name'. In 'E-mail Settings', 'Enable E-mail Notification' is 'Enabled', and there are input fields for 'From E-mail Address', 'To E-mail Address', and 'SMTP Server Address'. 'SMTP Server Port' is set to '25' and 'Enable Authentication' is 'Disabled'. In the 'E-mail Log When Full or On Schedule' section, both 'Send When Log Full' and 'Send on Schedule' are 'Disabled'. At the bottom, there is a copyright notice: 'COPYRIGHT © 2014 D-Link'.

Admin

This page will allow you to change the administrator (Admin) password and enable remote management.

In the Management menu on the bar on the top of the page, click **Admin**.

Password: Enter a new password for the administrator account. You will need to enter this password whenever you configure the router using a web browser.

Enable Graphical Authentication (CAPTCHA): Enables a challenge-response test to require users to type letters or numbers from a distorted image displayed on the screen to prevent online hackers and unauthorized users from gaining access to your router's network settings.

Enable HTTPS Server: Check to enable HTTPS to connect to the router securely. Instead of using **http://dlinkrouter.local/**, you must use **https://dlinkrouter.local/** in order to connect to the router.

Enable Remote Management: Remote management allows the DIR-895L to be configured from the Internet by a web browser. A password is still required to access the web management interface.

Remote Admin Port: The port number used to access the DIR-895L is used in the URL. Example: **http://x.x.x.x:8080** where x.x.x.x is the Internet IP address of the DIR-895L and 8080 is the port used for the web management interface.

Note: If you enabled **HTTPS Server** and wish to access the router remotely and securely, you must enter **https://** at the beginning of the address.

Click **Save** when you are done.

To load, save, or reset settings, or reboot the router, click **System** and refer to page 115.

System

This page allows you to save the router's current configuration, load a previously saved configuration, reset the router to its factory default settings, or reboot the router.

From the Admin page, click **System**. To return to the Admin page, click **Admin**.

Save Settings To Local Hard Drive: This option will save the current router configuration settings to a file on your computer.

Load Settings From Local Hard Drive: This option will load a previously saved router configuration file. This will overwrite the router's current configuration.

Restore To Factory Default Settings: This option will restore all configuration settings back to the settings that were in effect at the time the router was shipped from the factory. Any settings that have not been saved will be lost, including any rules that you have created. If you want to save the current router configuration settings, use the **Save Settings To Local Hard Drive** button above.

Auto Reboot Configuration: You may configure the router to automatically reboot at a set time. Please note, the router will be temporarily unavailable while rebooting.

Reboot The Device: Click to reboot the router immediately.

Auto Reboot: You may select **Never**, **Daily**, or **Weekly**.

Day of the week: Choose the day of the week to automatically reboot the router.

Time: Choose the time of day to automatically reboot the router.

Click **Save** when you are done.

D-Link
DIR-895L HW:A1 FW:1.00

Home | Settings | Features | Management

System

This page lets you save your router's current settings to a file, restore your settings from a file, restore your router to factory default settings, or reboot the device. Please note that restoring the settings to the factory defaults will erase all settings, including any rules you have created.

Management >> System [Admin](#) [Save](#)

System

Save Settings To Local Hard Drive: [Save](#)

Load Settings From Local Hard Drive: [Select File](#)

Restore To Factory Default Settings: [Restore](#)

Auto Reboot Configuration

Reboot The Device: [Reboot](#)

Auto Reboot: [Weekly](#) ▼

Date: [Mon](#) ▼

Time: [00](#) ▼ [00](#) ▼ (Hour/Minute)

COPYRIGHT © 2015-2016 D-Link

Upgrade

This page will allow you to upgrade the router's firmware or language pack, either automatically or manually. To manually upgrade the firmware or language pack, you must first download the relevant file from <http://support.dlink.com>.

In the Management menu on the bar on the top of the page, click **Upgrade**.

Firmware Information: The current firmware's version and date will be displayed.

Check for New Firmware: Click this button to prompt the router to automatically check for a new firmware version. If a newer version is found, it will prompt you to install it.

Upgrade Firmware: If you wish to upgrade manually, first download the firmware file you wish to upgrade to. Next, click the **Upgrade Firmware** button and browse to the file to install the new firmware. You can also browse to a language pack file to install a new language pack.

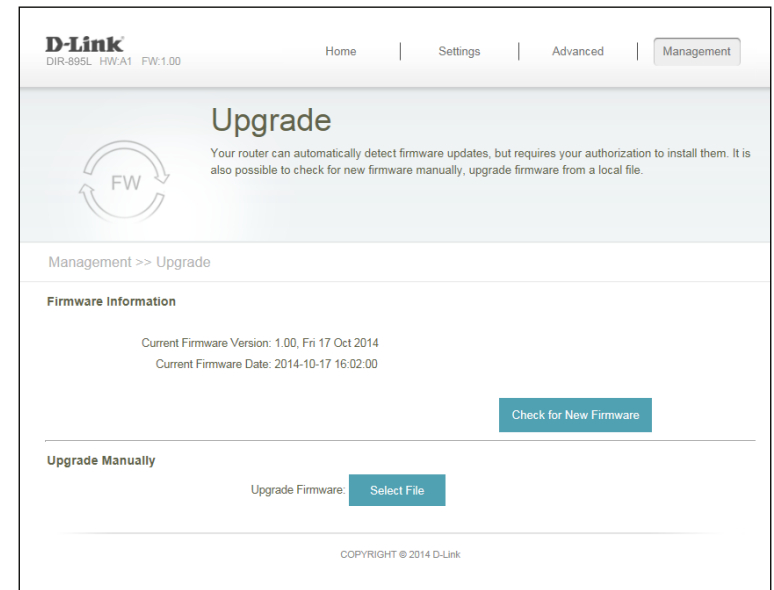

Statistics

On the Statistics page you can view the amount of packets that pass through the router on the WAN, LAN, and wireless segments.

In the Management menu on the bar on the top of the page, click **Statistics**.

You can view the **Internet**, **LAN**, **Wi-Fi 2.4 GHz**, or **Wi-Fi 5 GHz** by clicking on the respective tabs at the top. The graph will update in real time. To clear the information on the graph, click **Clear**.

The traffic counter will reset if the device is rebooted.



Connect a Wireless Client to your Router

WPS Button

The easiest and most secure way to connect your wireless devices to the router is with WPS (Wi-Fi Protected Setup). Most wireless devices such as wireless adapters, media players, Blu-ray DVD players, wireless printers and cameras will have a WPS button (or a software utility with WPS) that you can press to connect to the DIR-895L router. Please refer to your user manual for the wireless device you want to connect to make sure you understand how to enable WPS. Once you know, follow the steps below:

Step 1 - Press the WPS button on the DIR-895L for about 1 second. The Internet LED on the front will start to blink.



Step 2 - Within 2 minutes, press the WPS button on your wireless device (or launch the software utility and start the WPS process).

Step 3 - Allow up to 1 minute for your connection to be configured. Once the Internet light stops blinking, you will be connected and your wireless connection will be secure with WPA2.

Windows® 8

WPA/WPA2

It is recommended that you enable wireless security (WPA/WPA2) on your wireless router or access point before configuring your wireless adapter. If you are joining an existing network, you will need to know the security key (Wi-Fi password) being used.

To join an existing network, locate the wireless network icon in the taskbar next to the time display.



Clicking on this icon will display a list of wireless networks that are within connecting proximity of your computer. Select the desired network by clicking on the network name.

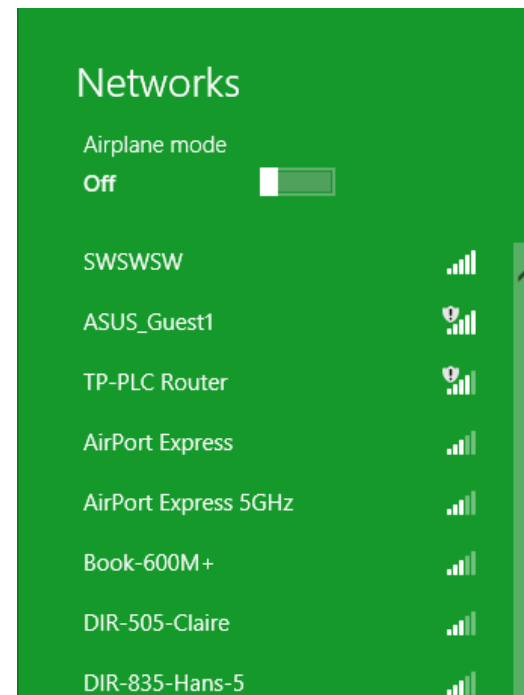

You will then be prompted to enter the network security key (Wi-Fi password) for the wireless network. Enter the password into the box and click **Next**.

If you wish to use Wi-Fi Protected Setup (WPS) to connect to the router, you can also press the WPS button on your router during this step to enable the WPS function.

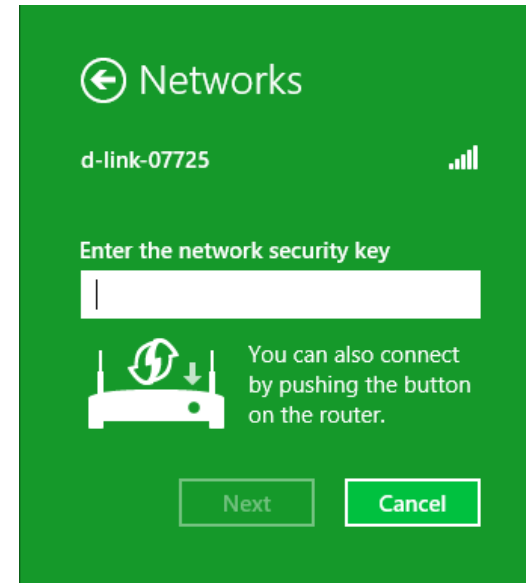

When you have established a successful connection to a wireless network, the word **Connected** will appear next to the name of the network to which you are connected to.

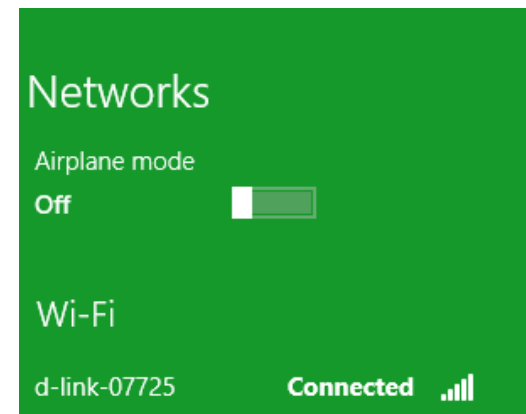

Windows® 7

WPA/WPA2

It is recommended that you enable wireless security (WPA/WPA2) on your wireless router or access point before configuring your wireless adapter. If you are joining an existing network, you will need to know the security key or passphrase being used.

1. Click on the wireless icon in your system tray (lower-right corner).

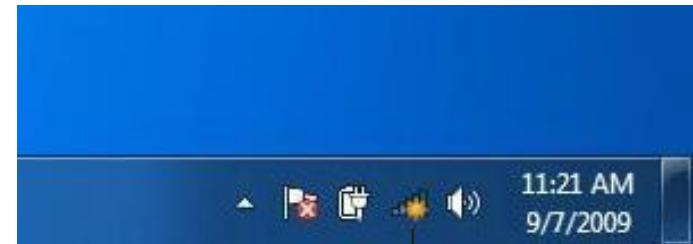

Wireless Icon

2. The utility will display any available wireless networks in your area.



3. Highlight the wireless connection with Wi-Fi name (SSID) you would like to connect to and click the **Connect** button.

If you get a good signal but cannot access the Internet, check your TCP/IP settings for your wireless adapter. Refer to the Networking Basics section in this manual for more information.



4. The following window appears while your computer tries to connect to the router.

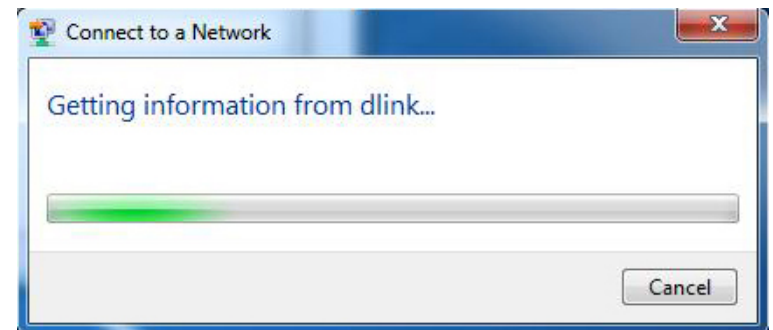

5. Enter the same security key or passphrase (Wi-Fi password) that is on your router and click **Connect**. You can also connect by pushing the WPS button on the router.

It may take 20-30 seconds to connect to the wireless network. If the connection fails, please verify that the security settings are correct. The key or passphrase must be exactly the same as the one on the wireless router.

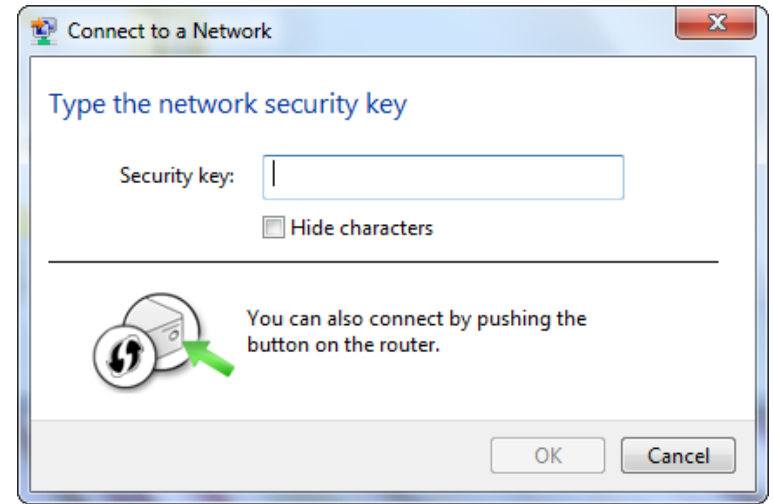

WPS

The WPS feature of the DIR-895L can be configured using Windows® 7. Carry out the following steps to use Windows® 7 to configure the WPS feature:

1. Click the **Start** button and select **Computer** from the Start menu.

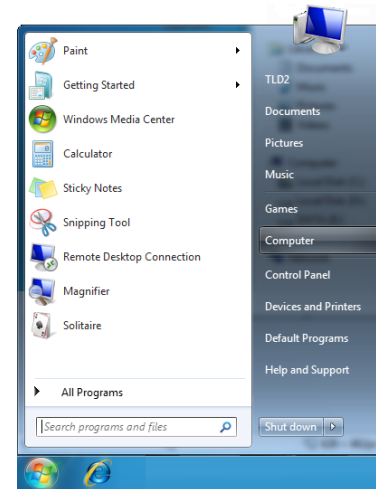

2. Click **Network** on the left side.

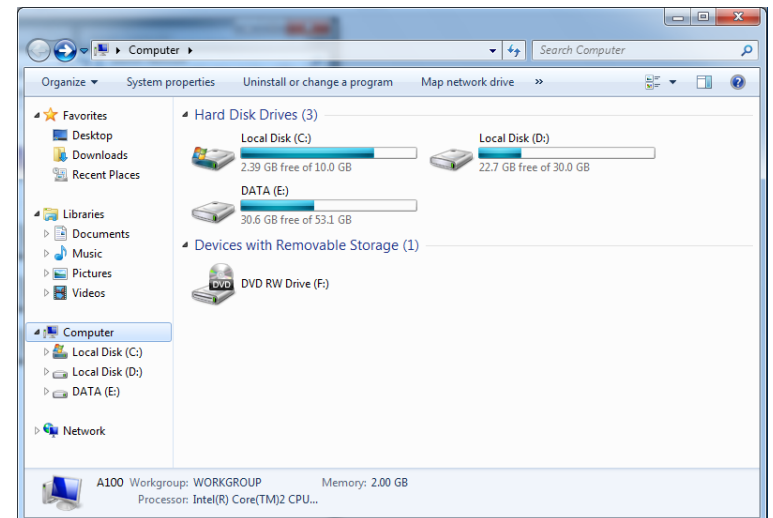

3. Double-click the DIR-895L.

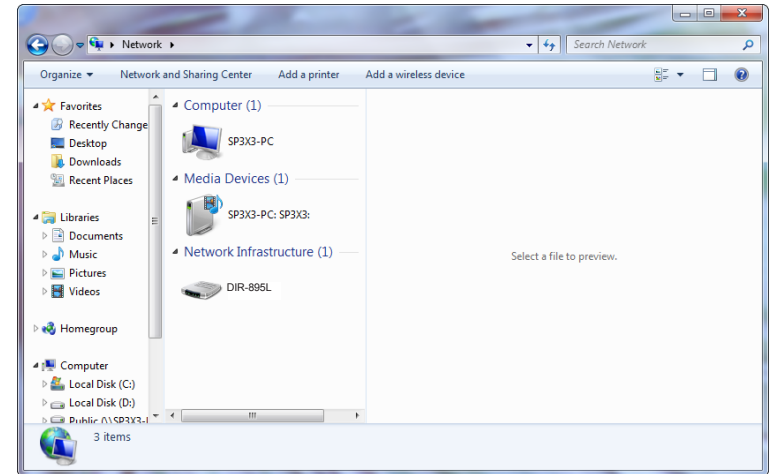

4. Input the WPS PIN number (on the router label) in the **Setup > Wireless Setup** menu in the Router's Web UI) and click **Next**.

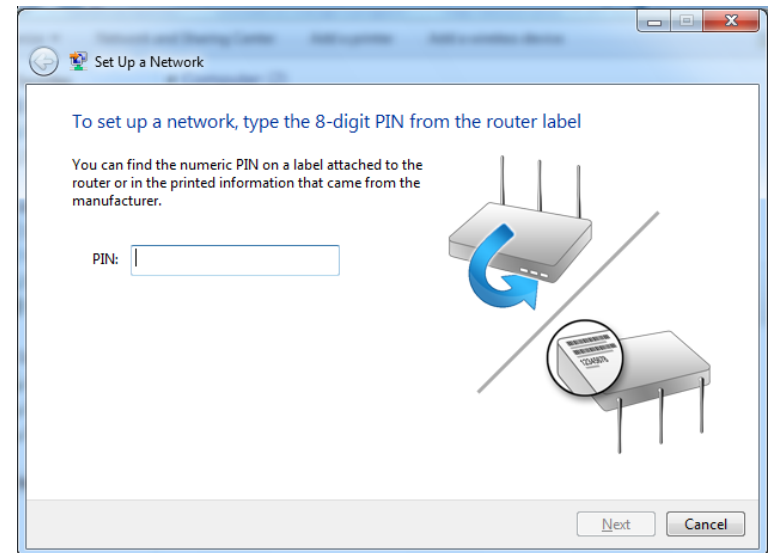

5. Type a name to identify the network.

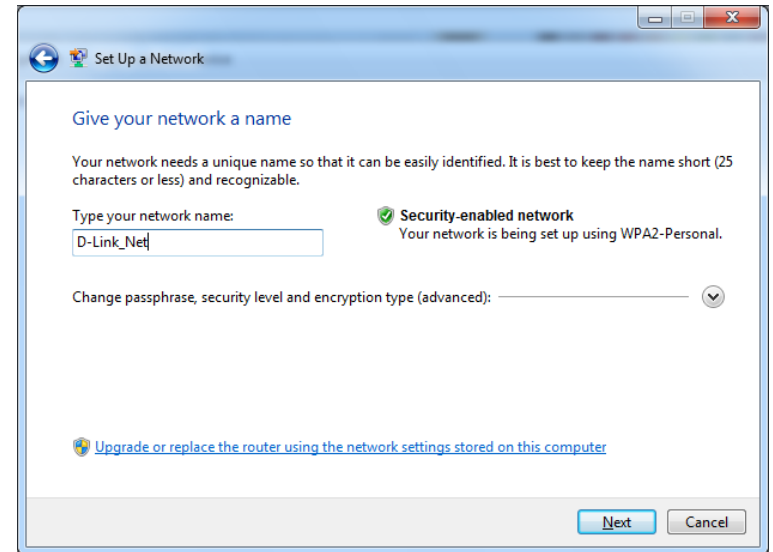

6. To configure advanced settings, click the  icon.

Click **Next** to continue.

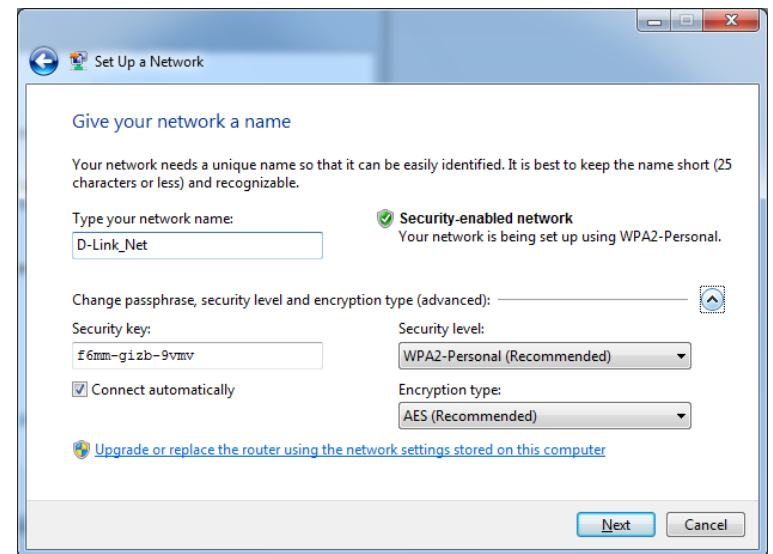

7. The following window appears while the Router is being configured.

Wait for the configuration to complete.

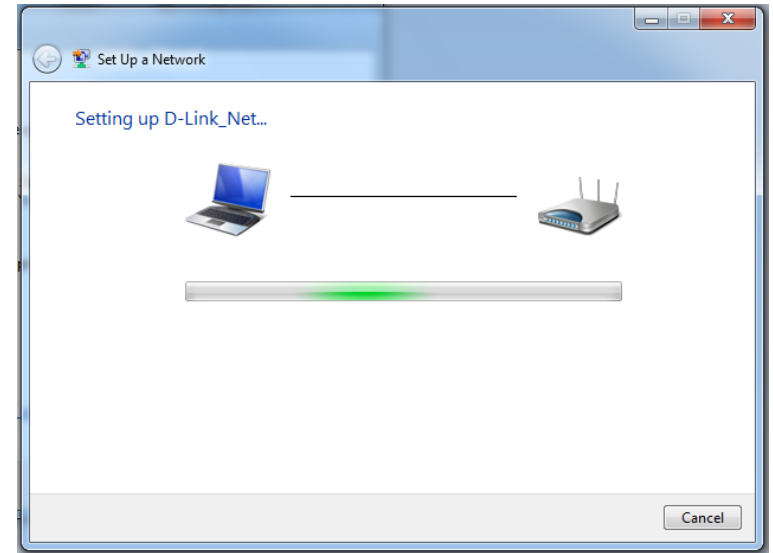

8. The following window informs you that WPS on the router has been set up successfully.

Make a note of the security key as you may need to provide this security key if adding an older wireless device to the network in the future.

9. Click **Close** to complete WPS setup.

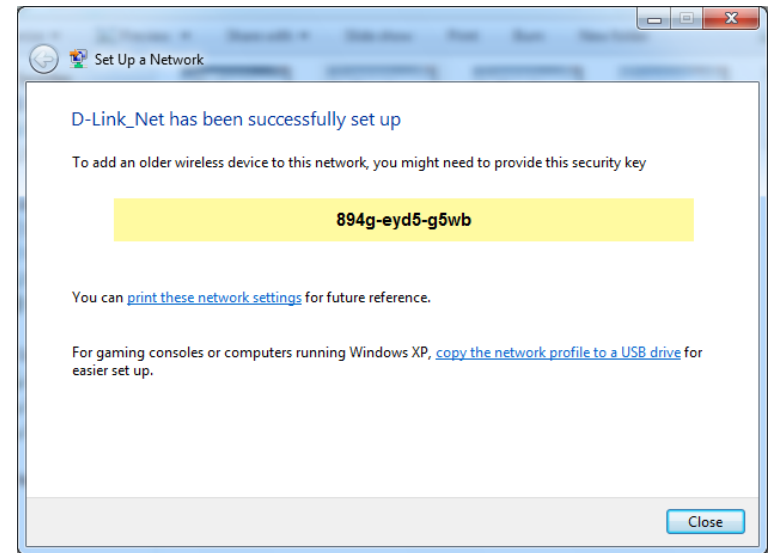

Windows Vista®

Windows Vista® users may use the built-in wireless utility. If you are using another company's wireless utility, please refer to the user manual of your wireless adapter for help connecting to a wireless network. Most wireless utilities will have a "site survey" option similar to the Windows Vista® utility as seen below.

If you receive the **Wireless Networks Detected** bubble, click on the center of the bubble to access the utility.

or

Right-click on the wireless computer icon in your system tray (lower-right corner next to the time). Select **Connect to a network**.



The utility will display any available wireless networks in your area. Click on a network (displayed using the SSID) and click the **Connect** button.

If you get a good signal but cannot access the Internet, check you TCP/IP settings for your wireless adapter. Refer to the **Networking Basics** section in this manual for more information.

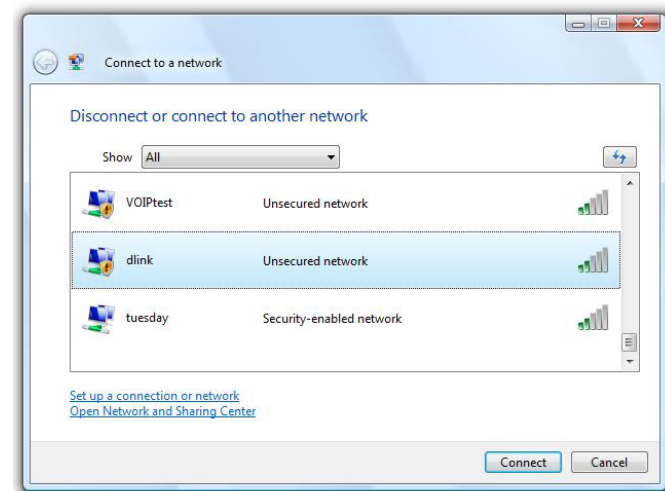

WPA/WPA2

It is recommended that you enable wireless security (WPA/WPA2) on your wireless router or access point before configuring your wireless adapter. If you are joining an existing network, you will need to know the security key or passphrase being used.

1. Open the Windows Vista® Wireless Utility by right-clicking on the wireless computer icon in your system tray (lower right corner of screen). Select **Connect to a network**.



2. Highlight the Wi-Fi name (SSID) you would like to connect to and click **Connect**.

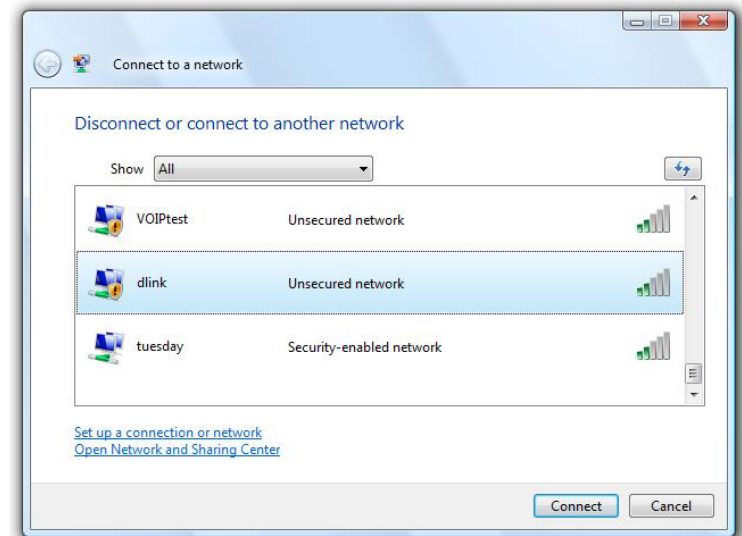

3. Enter the same security key or passphrase (Wi-Fi password) that is on your router and click **Connect**.

It may take 20-30 seconds to connect to the wireless network. If the connection fails, please verify that the security settings are correct. The key or passphrase must be exactly the same as the one on the wireless router.

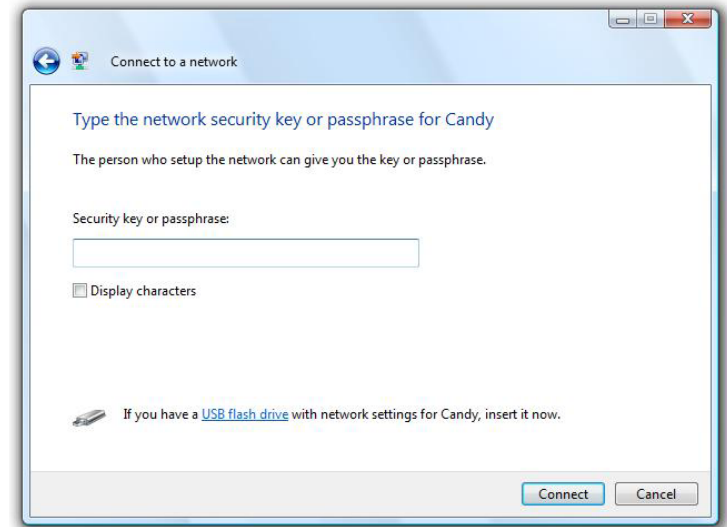

Windows® XP

Windows® XP users may use the built-in wireless utility (Zero Configuration Utility). The following instructions are for Service Pack 2 users. If you are using another company's utility, please refer to the user manual of your wireless adapter for help with connecting to a wireless network. Most utilities will have a "site survey" option similar to the Windows® XP utility as seen below.

If you receive the **Wireless Networks Detected** bubble, click on the center of the bubble to access the utility.

or

Right-click on the wireless computer icon in your system tray (lower-right corner next to the time). Select **View Available Wireless Networks**.

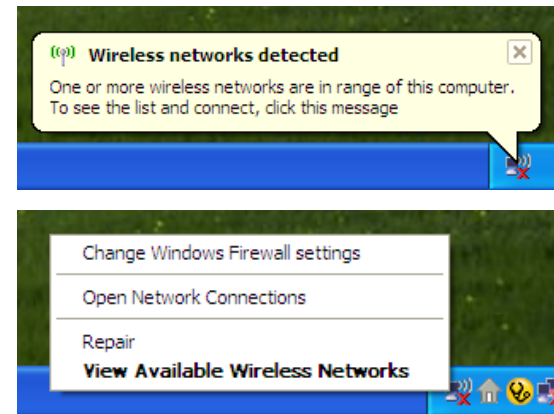

The utility will display any available wireless networks in your area. Click on a Wi-Fi network (displayed using the SSID) and click the **Connect** button.

If you get a good signal but cannot access the Internet, check you TCP/IP settings for your wireless adapter. Refer to the **Networking Basics** section in this manual for more information.

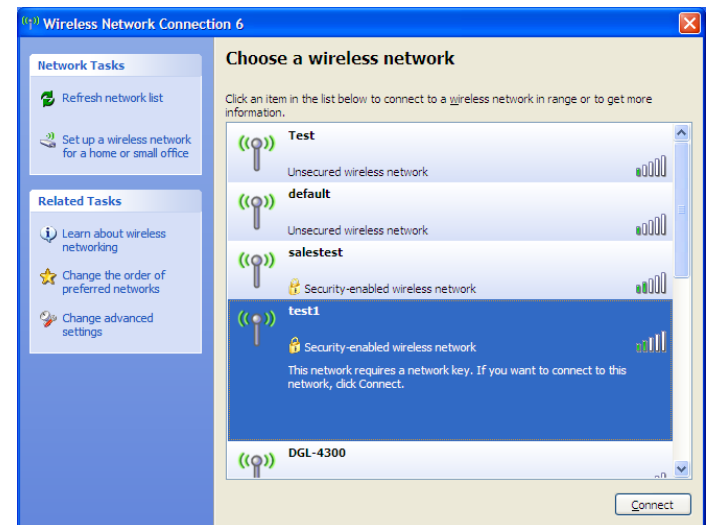

WPA/WPA2

It is recommended to enable WPA on your wireless router or access point before configuring your wireless adapter. If you are joining an existing network, you will need to know the WPA key being used.

1. Open the Windows® XP Wireless Utility by right-clicking on the wireless computer icon in your system tray (lower-right corner of screen). Select **View Available Wireless Networks**.

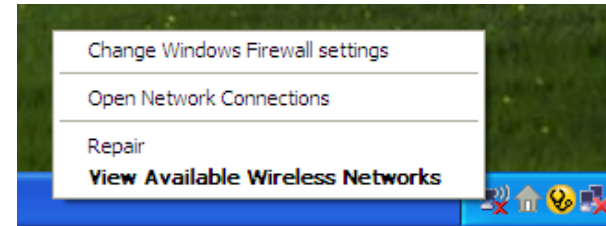

2. Highlight the Wi-Fi network (SSID) you would like to connect to and click **Connect**.

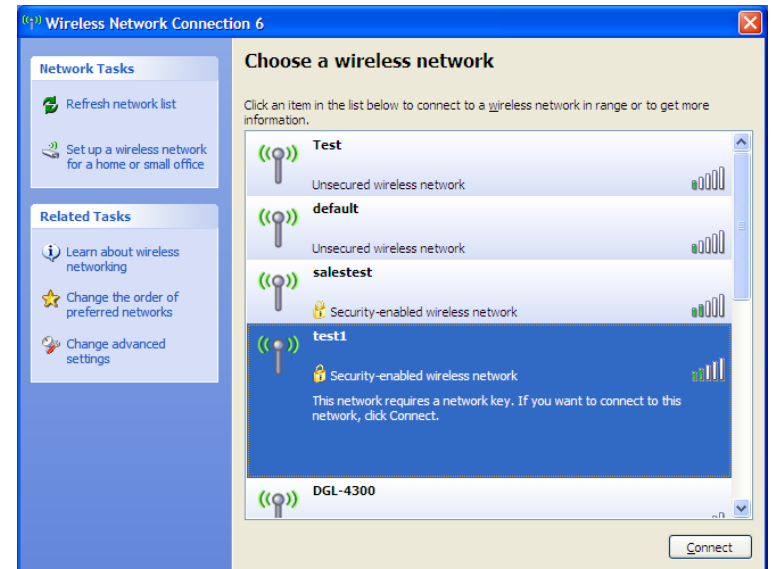

3. The **Wireless Network Connection** box will appear. Enter the WPA-PSK Wi-Fi password and click **Connect**.

It may take 20-30 seconds to connect to the wireless network. If the connection fails, please verify that the WPA-PSK settings are correct. The Wi-Fi password must be exactly the same as on the wireless router.

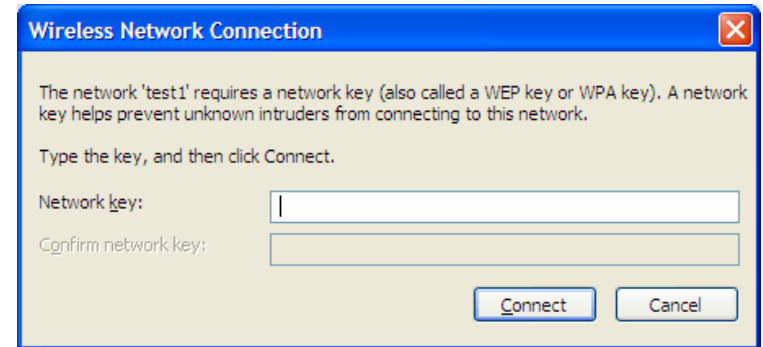

Troubleshooting

This chapter provides solutions to problems that can occur during the installation and operation of the DIR-895L. Read the following descriptions if you are having problems. The examples below are illustrated in Windows® XP. If you have a different operating system, the screenshots on your computer will look similar to these examples.

1. Why can't I access the web-based configuration utility?

When entering the IP address of the D-Link router (**192.168.0.1** for example), you are not connecting to a website, nor do you have to be connected to the Internet. The device has the utility built-in to a ROM chip in the device itself. Your computer must be on the same IP subnet to connect to the web-based utility.

- Make sure you have an updated Java-enabled web browser. We recommend the following:
 - Microsoft Internet Explorer® 7 or higher
 - Mozilla Firefox 3.5 or higher
 - Google™ Chrome 8 or higher
 - Apple Safari 4 or higher
- Verify physical connectivity by checking for solid link lights on the device. If you do not get a solid link light, try using a different cable, or connect to a different port on the device if possible. If the computer is turned off, the link light may not be on.
- Disable any Internet security software running on the computer. Software firewalls such as ZoneAlarm, BLACKICE, Sygate, Norton Personal Firewall, and Windows® XP firewall may block access to the configuration pages. Check the help files included with your firewall software for more information on disabling or configuring it.

- Configure your Internet settings:
 - Go to **Start > Settings > Control Panel**. Double-click the **Internet Options** icon. From the **Security** tab, click the button to restore the settings to their defaults.
 - Click the **Connection** tab and set the dial-up option to Never Dial a Connection. Click the LAN Settings button. Make sure nothing is checked. Click **OK**.
 - Go to the **Advanced** tab and click the button to restore these settings to their defaults. Click **OK** three times.
 - Close your web browser (if open) and open it.
- Access the web management. Open your web browser and enter the IP address of your D-Link router in the address bar. This should open the login page for your web management.
- If you still cannot access the configuration, unplug the power to the router for 10 seconds and plug back in. Wait about 30 seconds and try accessing the configuration. If you have multiple computers, try connecting using a different computer.

2. What can I do if I forgot my password?

If you forgot your password, you must reset your router. This process will change all your settings back to the factory defaults.

To reset the router, locate the reset button (hole) on the rear panel of the unit. With the router powered on, use a paperclip to hold the button down for 10 seconds. Release the button and the router will go through its reboot process. Wait about 30 seconds to access the router. The default IP address is **192.168.0.1**. When logging in, leave the password box empty.

3. Why can't I connect to certain sites or send and receive emails when connecting through my router?

If you are having a problem sending or receiving email, or connecting to secure sites such as eBay, banking sites, and Hotmail, we suggest lowering the MTU in increments of ten (Ex. 1492, 1482, 1472, etc).

To find the proper MTU Size, you'll have to do a special ping of the destination you're trying to go to. A destination could be another computer, or a URL.

- Click on **Start** and then click **Run**.
- Windows® 95, 98, and Me users type in **command** (Windows® NT, 2000, XP, Vista®, and 7 users type in **cmd**) and press **Enter** (or click **OK**).
- Once the window opens, you'll need to do a special ping. Use the following syntax:

ping [url] [-f] [-l] [MTU value]

Example: **ping yahoo.com -f -l 1472**

```
C:\>ping yahoo.com -f -l 1482
Pinging yahoo.com [66.94.234.13] with 1482 bytes of data:
Packet needs to be fragmented but DF set.
Packet needs to be fragmented but DF set.
Packet needs to be fragmented but DF set.
Packet needs to be fragmented but DF set.
Ping statistics for 66.94.234.13:
    Packets: Sent = 4, Received = 0, Lost = 4 (100% loss),
    Approximate round trip times in milli-seconds:
        Minimum = 0ms, Maximum = 0ms, Average = 0ms
C:\>ping yahoo.com -f -l 1472
Pinging yahoo.com [66.94.234.13] with 1472 bytes of data:
Reply from 66.94.234.13: bytes=1472 time=93ms TTL=52
Reply from 66.94.234.13: bytes=1472 time=109ms TTL=52
Reply from 66.94.234.13: bytes=1472 time=125ms TTL=52
Reply from 66.94.234.13: bytes=1472 time=203ms TTL=52
Ping statistics for 66.94.234.13:
    Packets: Sent = 4, Received = 4, Lost = 0 (0% loss),
    Approximate round trip times in milli-seconds:
        Minimum = 93ms, Maximum = 203ms, Average = 132ms
C:\>
```

You should start at 1472 and work your way down by 10 each time. Once you get a reply, go up by 2 until you get a fragmented packet. Take that value and add 28 to the value to account for the various TCP/IP headers. For example, let's say that 1452 was the proper value, the actual MTU size would be 1480, which is the optimum for the network we're working with ($1452+28=1480$).

Once you find your MTU, you can now configure your router with the proper MTU size.

To change the MTU rate on your router follow the steps below:

- Open your browser, enter the IP address of your router (192.168.0.1) and click **OK**.
- Enter your username (admin) and password (blank by default). Click **OK** to enter the web configuration page for the device.
- Click on **Setup** and then click **Manual Configure**.
- To change the MTU, enter the number in the MTU field and click **Save Settings** to save your settings.
- Test your email. If changing the MTU does not resolve the problem, continue changing the MTU in increments of ten.

Wireless Basics

D-Link wireless products are based on industry standards to provide easy-to-use and compatible high-speed wireless connectivity within your home, business, or public access wireless networks. Strictly adhering to the IEEE standard, the D-Link wireless family of products will allow you to securely access the data you want, when, and where you want it. You will be able to enjoy the freedom that wireless networking delivers.

A wireless local area network (WLAN) is a cellular computer network that transmits and receives data with radio signals instead of wires. Wireless LANs are used increasingly in both home and office environments, and public areas such as airports, coffee shops and universities. Innovative ways to utilize WLAN technology are helping people work, and communicate more efficiently. Increased mobility and the absence of cabling and other fixed infrastructure have proven to be beneficial for many users.

Wireless users can use the same applications they use on a wired network. Wireless adapter cards used on laptop and desktop systems support the same protocols as Ethernet adapter cards.

Under many circumstances, it may be desirable for mobile network devices to link to a conventional Ethernet LAN in order to use servers, printers or an Internet connection supplied through the wired LAN. A wireless router is a device used to provide this link.

What is Wireless?

Wireless or Wi-Fi technology is another way of connecting your computer to the network without using wires. Wi-Fi uses radio frequency to connect wirelessly so you have the freedom to connect computers anywhere in your home or office network.

Why D-Link Wireless?

D-Link is the worldwide leader and award winning designer, developer, and manufacturer of networking products. D-Link delivers the performance you need at a price you can afford. D-Link has all the products you need to build your network.

How does wireless work?

Wireless works similarly to how cordless phones work, through radio signals that transmit data from one point A to point B. But wireless technology has restrictions as to how you can access the network. You must be within the wireless network range area to be able to connect your computer. There are two different types of wireless networks: Wireless Local Area Network (WLAN), and Wireless Personal Area Network (WPAN).

Wireless Local Area Network (WLAN)

In a wireless local area network, a device called an Access Point (AP) connects computers to the network. The access point has a small antenna attached to it, which allows it to transmit data back and forth over radio signals. With an indoor access point the signal can travel up to 300 feet. With an outdoor access point the signal can reach out up to 30 miles to serve places like manufacturing plants, industrial locations, university and high school campuses, airports, golf courses, and many other outdoor venues.

Wireless Personal Area Network (WPAN)

Bluetooth is the industry standard wireless technology used for WPAN. Bluetooth devices in WPAN operate in a range up to 30 feet away.

Compared to WLAN the speed and wireless operation range are both less than WLAN, but in return it doesn't use nearly as much power. This makes it ideal for personal devices, such as mobile phones, PDAs, headphones, laptops, speakers, and other devices that operate on batteries.

Who uses wireless?

Wireless technology has become so popular in recent years that almost everyone is using it, whether it's for home, office, business, D-Link has a wireless solution for it.

Home Uses/Benefits

- Gives everyone at home broadband access
- Surf the web, check email, instant message, etc.
- Gets rid of the cables around the house
- Simple and easy to use

Small Office and Home Office Uses/Benefits

- Stay on top of everything at home as you would at office
- Remotely access your office network from home
- Share Internet connection and printer with multiple computers
- No need to dedicate office space

Where is wireless used?

Wireless technology is expanding everywhere, not just at home or office. People like the freedom of mobility and it's becoming so popular that more and more public facilities now provide wireless access to attract people. The wireless connection in public places is usually called "hotspots".

Using a D-Link CardBus adapter with your laptop, you can access the hotspot to connect to the Internet from remote locations like: airports, hotels, coffee shops, libraries, restaurants, and convention centers.

Wireless network is easy to setup, but if you're installing it for the first time it could be quite a task not knowing where to start. That's why we've put together a few setup steps and tips to help you through the process of setting up a wireless network.

Tips

Here are a few things to keep in mind, when you install a wireless network.

Centralize your router or access point

Make sure you place the router/access point in a centralized location within your network for the best performance. Try to place the router/access point as high as possible in the room, so the signal gets dispersed throughout your home. If you have a two-story home, you may need a repeater to boost the signal to extend the range.

Eliminate Interference

Place home appliances such as cordless telephones, microwaves, and televisions as far away as possible from the router/access point. This would significantly reduce any interference that the appliances might cause since they operate on same frequency.

Security

Don't let your next-door neighbors or intruders connect to your wireless network. Secure your wireless network by turning on the WPA or WEP security feature on the router. Refer to the product manual for detail information on how to set it up.

Wireless Modes

There are basically two modes of networking:

- **Infrastructure** – All wireless clients will connect to an access point or wireless router.
- **Ad-hoc** – Directly connecting to another computer for peer-to-peer communication using wireless network adapters on each computer, such as two or more DIR-895L wireless network CardBus adapters.

An Infrastructure network contains an access point or wireless router. All the wireless devices, or clients, will connect to the wireless router or access point.

An Ad-hoc network contains only clients, such as laptops with wireless CardBus adapters. All the adapters must be in Ad-hoc mode to communicate.

Networking Basics

Check your IP address

To verify your IP address, please follow the steps below:

Windows® 8 Users

- Press the **Windows key** and **R** together. Type **cmd** in the box and click **OK**.
- At the prompt, type **ipconfig** and press **Enter**.
- This will display the IP address, subnet mask, and default gateway of your adapter.

Windows® 7/Vista® Users

- Click **Start**, type **cmd** in the search box and then click **OK**.
- At the prompt, type **ipconfig** and press **Enter**.
- This will display the IP address, subnet mask, and default gateway of your adapter.

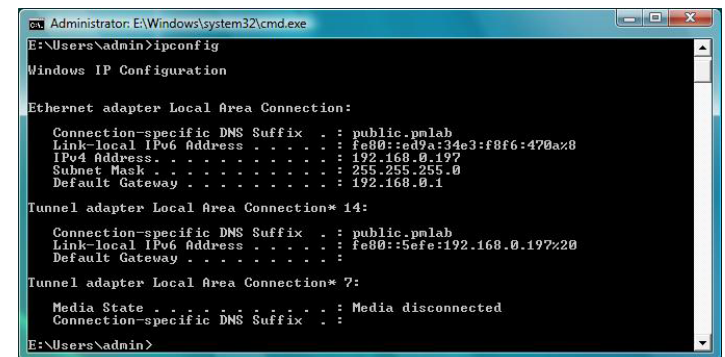

```
Administrator: E:\Windows\system32\cmd.exe
E:\Users\Admin>ipconfig

Windows IP Configuration

Ethernet adapter Local Area Connection:

    Connection-specific DNS Suffix  . : public.pmlab
    Link-local IPv6 Address . . . . . : fe80::ed9a:34e3:f8f6:470a%8
    IPv4 Address. . . . . : 192.168.0.197
    Subnet Mask . . . . . : 255.255.255.0
    Default Gateway . . . . . : 192.168.0.1

Tunnel adapter Local Area Connection* 14:

    Connection-specific DNS Suffix  . : public.pmlab
    Link-local IPv6 Address . . . . . : fe80::5efe:192.168.0.197%20
    Default Gateway . . . . . :

Tunnel adapter Local Area Connection* 7:

    Media State . . . . . : Media disconnected
    Connection-specific DNS Suffix  . :

E:\Users\Admin>
```

If the address is 0.0.0.0, check your adapter installation, security settings, and the settings on your router. Some firewall software programs may block a DHCP request on newly installed adapters.

Statically Assign an IP address

If you are not using a DHCP capable gateway/router, or you need to assign a static IP address, please follow the steps below:

Windows® 8 Users

- Press the **Windows** key and then type **IP**. Click **Settings** on the right side and then click **View Network Connections**.
- Right-click on the adapter which represents your D-Link wireless network adapter.
- Highlight **Internet Protocol Version 4 (TCP /IPv4)** and click **Properties**.

- Click **Use the following IP address** and enter an IP address that is on the same subnet as your network or LAN IP address on your router or network.

Example: If the router's LAN IP address is 192.168.0.1, make your IP address 192.168.0.X where X is a number between 2 and 99. Make sure that the number you choose is not in use on the network.

- Set **Default Gateway** the same as the LAN IP address of your router or gateway.
- Set **Primary DNS** the same as the LAN IP address of your router or gateway.
- The **Secondary DNS** is optional (you may enter a DNS server from your ISP).
- Click **OK** to save your settings.

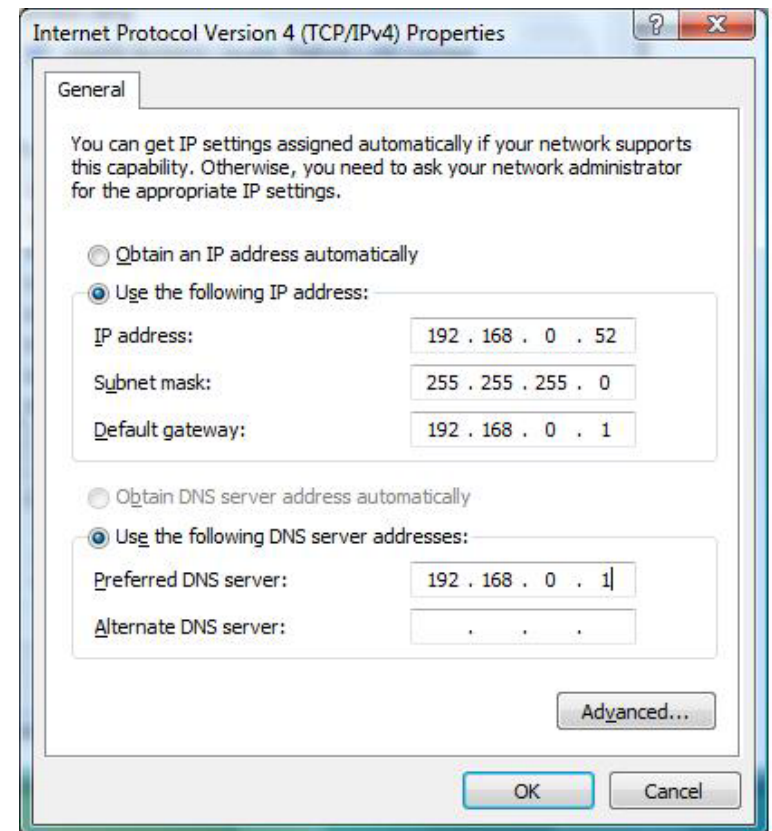

Windows® 7/ Vista® Users

- Click on **Start > Control Panel** (make sure you are in Classic View). Double-click on the **Network and Sharing Center** icon. If you are using Windows Vista, click on **Manage network connections** along the left panel in the window. For Windows® 7, click on **Change adapter settings**.
- Right-click on the **Local Area Connection** which represents your D-Link wireless network adapter which will be connected to your network.
- Highlight **Internet Protocol Version 4 (TCP /IPv4)** and click **Properties**.
- Click **Use the following IP address** and enter an IP address that is on the same subnet as your network or LAN IP address on your router or network.

Example: If the router's LAN IP address is 192.168.0.1, make your IP address 192.168.0.X where X is a number between 2 and 99. Make sure that the number you choose is not in use on the network.

- Set **Default Gateway** the same as the LAN IP address of your router or gateway.
- Set **Primary DNS** the same as the LAN IP address of your router or gateway.
- The **Secondary DNS** is optional (you may enter a DNS server from your ISP).
- Click **OK** to save your settings.

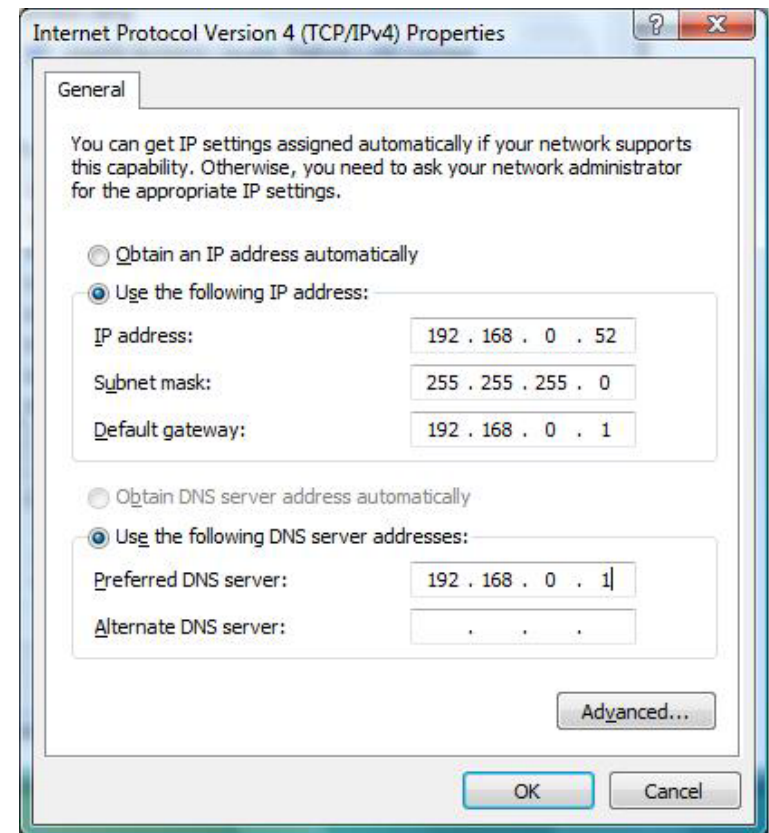

Technical Specifications

Device Interfaces

- 802.11 ac/n/g/b/a wireless LAN
- Four 10/100/1000 Gigabit LAN ports
- 10/100/1000 Gigabit WAN port
- Two USB ports (one USB 3.0, one USB 2.0)

Antenna Types

- Eight external antennas

Standards

- IEEE 802.11ac
- IEEE 802.11n
- IEEE 802.11g
- IEEE 802.11b
- IEEE 802.11a
- IEEE 802.3
- IEEE 802.3u

Security

- WPA™ - Personal/Enterprise
- WPA2™ - Personal/Enterprise
- Wi-Fi Protected Setup (WPS) PIN/PBC

Power

- Input: 100 to 240 V AC, 50/60 Hz
- Output: 12 V DC, 5 A

USB Port Power

- 5 V / 0.9 A

Operating Temperature

- 0 to 40 °C (32 to 104 °F)

Operating Humidity

- 10% to 95% maximum (non-condensing)

Certifications

- FCC Class B
- CSA/LVD
- CE Class B
- C-Tick
- IPv6 Ready
- Wi-Fi Protected Setup (WPS)
- Wi-Fi Multimedia (WMM)
- Compatible with Windows 8

Dimensions

- L = 417.73 mm (16.44 inches)
- W = 262.72 mm (10.34 inches)
- H = 49.6 mm (5.89 inches)

Note:

- Maximum wireless signal rate derived from IEEE Standard 802.11a, 802.11g, 802.11n, and 802.11ac specifications. Actual data throughput will vary. Network conditions and environmental factors, including volume of network traffic, building materials and construction, and network overhead, lower actual data throughput rate. Environmental factors will adversely affect wireless signal range.
- Frequency Range varies depending on country's regulation.
- The DIR-895L does not include 5.25-5.35 GHz & 5.47-5.725 GHz in some regions.

Contacting Technical Support

U.S. and Canadian customers can contact D-Link technical support through our web site or by phone.

Before you contact technical support, please have the following ready:

- Model number of the product (e.g. DIR-895L)
- Hardware Revision (located on the label on the bottom of the router (e.g. rev A1))
- Serial Number (s/n number located on the label on the bottom of the router).

You can find software updates and user documentation on the D-Link website as well as frequently asked questions and answers to technical issues.

For customers within the United States:

Phone Support:

(877) 453-5465

Internet Support:

<http://support.dlink.com>

For customers within Canada:

Phone Support:

(800) 361-5265

Internet Support:

<http://support.dlink.ca>

Warranty

Subject to the terms and conditions set forth herein, D-Link Systems, Inc. (“D-Link”) provides this Limited Warranty:

- Only to the person or entity that originally purchased the product from D-Link or its authorized reseller or distributor, and
- Only for products purchased and delivered within the fifty states of the United States, the District of Columbia, U.S. Possessions or Protectorates, U.S. Military Installations, or addresses with an APO or FPO.

Limited Warranty:

D-Link warrants that the hardware portion of the D-Link product described below (“Hardware”) will be free from material defects in workmanship and materials under normal use from the date of original retail purchase of the product, for the period set forth below (“Warranty Period”), except as otherwise stated herein.

- One (1) Year Limited Warranty

The customer’s sole and exclusive remedy and the entire liability of D-Link and its suppliers under this Limited Warranty will be, at D-Link’s option, to repair or replace the defective Hardware during the Warranty Period at no charge to the original owner or to refund the actual purchase price paid. Any repair or replacement will be rendered by D-Link at an Authorized D-Link Service Office. The replacement hardware need not be new or have an identical make, model or part. D-Link may, at its option, replace the defective Hardware or any part thereof with any reconditioned product that D-Link reasonably determines is substantially equivalent (or superior) in all material respects to the defective Hardware. Repaired or replacement hardware will be warranted for the remainder of the original Warranty Period or ninety (90) days, whichever is longer, and is subject to the same limitations and exclusions. If a material defect is incapable of correction, or if D-Link determines that it is not practical to repair or replace the defective Hardware, the actual price paid by the original purchaser for the defective Hardware will be refunded by D-Link upon return to D-Link of the defective Hardware. All Hardware or part thereof that is replaced by D-Link, or for which the purchase price is refunded, shall become the property of D-Link upon replacement or refund.

Limited Software Warranty:

D-Link warrants that the software portion of the product (“Software”) will substantially conform to D-Link’s then current functional specifications for the Software, as set forth in the applicable documentation, from the date of original retail purchase of the Software for a period of ninety (90) days (“Software Warranty Period”), provided that the Software is properly installed on approved hardware and operated as contemplated in its documentation. D-Link further warrants that, during the Software Warranty Period, the magnetic media on which D-Link delivers the Software will be free of physical defects. The customer’s sole and exclusive remedy and the entire liability of D-Link and its suppliers under this Limited Warranty will be, at D-Link’s option, to replace the non-conforming Software (or defective media) with software that substantially conforms to D-Link’s functional specifications for the Software or to refund the portion of the actual purchase price paid that is attributable to the Software. Except as otherwise agreed by D-Link in writing, the replacement Software is provided only to the original licensee, and is subject to the terms and conditions of the license granted by D-Link for the Software. Replacement Software will be warranted for the remainder of the original Warranty Period and is subject to the same limitations and exclusions. If a material non-conformance is incapable of correction, or if D-Link determines in its sole discretion that it is not practical to replace the non-conforming Software, the price paid by the original licensee for the non-conforming Software will be refunded by D-Link; provided that the non-conforming Software (and all copies thereof) is first returned to D-Link. The license granted respecting any Software for which a refund is given automatically terminates.

Non-Applicability of Warranty:

The Limited Warranty provided hereunder for Hardware and Software portions of D-Link’s products will not be applied to and does not cover any refurbished product and any product purchased through the inventory clearance or liquidation sale or other sales in which D-Link, the sellers, or the liquidators expressly disclaim their warranty obligation pertaining to the product and in that case, the product is being sold “As-Is” without any warranty whatsoever including, without limitation, the Limited Warranty as described herein, notwithstanding anything stated herein to the contrary.

Submitting A Claim (USA):

The customer shall return the product to the original purchase point based on its return policy. In case the return policy period has expired and the product is within warranty, the customer shall submit a claim to D-Link as outlined below:

- The customer must submit with the product as part of the claim a written description of the Hardware defect or Software nonconformance in sufficient detail to allow D-Link to confirm the same, along with proof of purchase of the product (such as a copy of the dated purchase invoice for the product) if the product is not registered.
- The customer must obtain a Case ID Number from D-Link Technical Support at 1-877-453-5465, who will attempt to assist the customer in resolving any suspected defects with the product. If the product is considered defective, the customer must obtain a Return Material Authorization (“RMA”) number by completing the RMA form and entering the assigned Case ID Number at <https://rma.dlink.com/>.

- After an RMA number is issued, the defective product must be packaged securely in the original or other suitable shipping package to ensure that it will not be damaged in transit, and the RMA number must be prominently marked on the outside of the package. Do not include any manuals or accessories in the shipping package. D-Link will only replace the defective portion of the product and will not ship back any accessories.
- The customer is responsible for all in-bound shipping charges to D-Link. No Cash on Delivery (“COD”) is allowed. Products sent COD will either be rejected by D-Link or become the property of D-Link. Products shall be fully insured by the customer and shipped to D-Link Systems, Inc., 17595 Mt. Herrmann, Fountain Valley, CA 92708. D-Link will not be held responsible for any packages that are lost in transit to D-Link. The repaired or replaced packages will be shipped to the customer via UPS Ground or any common carrier selected by D-Link. Return shipping charges shall be prepaid by D-Link if you use an address in the United States, otherwise we will ship the product to you freight collect. Expedited shipping is available upon request and provided shipping charges are prepaid by the customer. D-Link may reject or return any product that is not packaged and shipped in strict compliance with the foregoing requirements, or for which an RMA number is not visible from the outside of the package. The product owner agrees to pay D-Link’s reasonable handling and return shipping charges for any product that is not packaged and shipped in accordance with the foregoing requirements, or that is determined by D-Link not to be defective or non-conforming.

Submitting A Claim (Canada):

The customer shall return the product to the original purchase point based on its return policy. In case the return policy period has expired and the product is within warranty, the customer shall submit a claim to D-Link as outlined below:

- Customers need to provide their receipt (proof of purchase) even if the product is registered. Without a receipt, no warranty service will be done. The registration is not considered a proof of purchase.
- The customer must submit with the product as part of the claim a written description of the Hardware defect or Software nonconformance in sufficient detail to allow D-Link to confirm the same, along with proof of purchase of the product (such as a copy of the dated purchase invoice for the product) if the product is not registered.
- The customer must obtain a Case ID Number from D-Link Technical Support at 1-800-361-5265, who will attempt to assist the customer in resolving any suspected defects with the product. If the product is considered defective, the customer must obtain a Return Material Authorization (“RMA”) number by completing the RMA form and entering the assigned Case ID Number at <https://rma.dlink.ca/>.
- After an RMA number is issued, the defective product must be packaged securely in the original or other suitable shipping package to ensure that it will not be damaged in transit, and the RMA number must be prominently marked on the outside of the package. Do not include any manuals or accessories in the shipping package. D-Link will only replace the defective portion of the product and will not ship back any accessories.

- The customer is responsible for all in-bound shipping charges to D-Link. No Cash on Delivery (“COD”) is allowed. Products sent COD will be rejected by D-Link. Products shall be fully insured by the customer and shipped to D-Link Networks, Inc., 2525 Meadowvale Boulevard Mississauga, Ontario, L5N 5S2 Canada. D-Link will not be held responsible for any packages that are lost in transit to D-Link. The repaired or replaced packages will be shipped to the customer via Purolator Canada or any common carrier selected by D-Link. Return shipping charges shall be prepaid by D-Link if you use an address in Canada, otherwise we will ship the product to you freight collect. Expedited shipping is available upon request and provided shipping charges are prepaid by the customer. D-Link may reject or return any product that is not packaged and shipped in strict compliance with the foregoing requirements, or for which an RMA number is not visible from the outside of the package. The product owner agrees to pay D-Link’s reasonable handling and return shipping charges for any product that is not packaged and shipped in accordance with the foregoing requirements, or that is determined by D-Link not to be defective or non-conforming.
- RMA phone number: 1-800-361-5265 Hours of Operation: Monday-Friday, 9:00AM – 9:00PM EST

What Is Not Covered:

The Limited Warranty provided herein by D-Link does not cover:

Products that, in D-Link’s judgment, have been subjected to abuse, accident, alteration, modification, tampering, negligence, misuse, faulty installation, lack of reasonable care, repair or service in any way that is not contemplated in the documentation for the product, or if the model or serial number has been altered, tampered with, defaced or removed; Initial installation, installation and removal of the product for repair, and shipping costs; Operational adjustments covered in the operating manual for the product, and normal maintenance; Damage that occurs in shipment, due to act of God, failures due to power surge, and cosmetic damage; Any hardware, software, firmware or other products or services provided by anyone other than D-Link; and Products that have been purchased from inventory clearance or liquidation sales or other sales in which D-Link, the sellers, or the liquidators expressly disclaim their warranty obligation pertaining to the product.

While necessary maintenance or repairs on your Product can be performed by any company, we recommend that you use only an Authorized D-Link Service Office. Improper or incorrectly performed maintenance or repair voids this Limited Warranty.

Disclaimer of Other Warranties:

EXCEPT FOR THE LIMITED WARRANTY SPECIFIED HEREIN, THE PRODUCT IS PROVIDED “AS-IS” WITHOUT ANY WARRANTY OF ANY KIND WHATSOEVER INCLUDING, WITHOUT LIMITATION, ANY WARRANTY OF MERCHANTABILITY, FITNESS FOR A PARTICULAR PURPOSE AND NONINFRINGEMENT.

IF ANY IMPLIED WARRANTY CANNOT BE DISCLAIMED IN ANY TERRITORY WHERE A PRODUCT IS SOLD, THE DURATION OF SUCH IMPLIED WARRANTY SHALL BE LIMITED TO THE DURATION OF THE APPLICABLE WARRANTY PERIOD SET FORTH ABOVE. EXCEPT AS EXPRESSLY COVERED UNDER THE LIMITED WARRANTY PROVIDED HEREIN, THE ENTIRE RISK AS TO THE QUALITY, SELECTION AND PERFORMANCE OF THE PRODUCT IS WITH THE PURCHASER OF THE PRODUCT.

Limitation of Liability:

TO THE MAXIMUM EXTENT PERMITTED BY LAW, D-LINK IS NOT LIABLE UNDER ANY CONTRACT, NEGLIGENCE, STRICT LIABILITY OR OTHER LEGAL OR EQUITABLE THEORY FOR ANY LOSS OF USE OF THE PRODUCT, INCONVENIENCE OR DAMAGES OF ANY CHARACTER, WHETHER DIRECT, SPECIAL, INCIDENTAL OR CONSEQUENTIAL (INCLUDING, BUT NOT LIMITED TO, DAMAGES FOR LOSS OF GOODWILL, LOSS OF REVENUE OR PROFIT, WORK STOPPAGE, COMPUTER FAILURE OR MALFUNCTION, FAILURE OF OTHER EQUIPMENT OR COMPUTER PROGRAMS TO WHICH D-LINK'S PRODUCT IS CONNECTED WITH, LOSS OF INFORMATION OR DATA CONTAINED IN, STORED ON, OR INTEGRATED WITH ANY PRODUCT RETURNED TO D-LINK FOR WARRANTY SERVICE) RESULTING FROM THE USE OF THE PRODUCT, RELATING TO WARRANTY SERVICE, OR ARISING OUT OF ANY BREACH OF THIS LIMITED WARRANTY, EVEN IF D-LINK HAS BEEN ADVISED OF THE POSSIBILITY OF SUCH DAMAGES. THE SOLE REMEDY FOR A BREACH OF THE FOREGOING LIMITED WARRANTY IS REPAIR, REPLACEMENT OR REFUND OF THE DEFECTIVE OR NONCONFORMING PRODUCT. THE MAXIMUM LIABILITY OF D-LINK UNDER THIS WARRANTY IS LIMITED TO THE PURCHASE PRICE OF THE PRODUCT COVERED BY THE WARRANTY. THE FOREGOING EXPRESS WRITTEN WARRANTIES AND REMEDIES ARE EXCLUSIVE AND ARE IN LIEU OF ANY OTHER WARRANTIES OR REMEDIES, EXPRESS, IMPLIED OR STATUTORY.

Governing Law:

This Limited Warranty shall be governed by the laws of the State of California. Some states do not allow exclusion or limitation of incidental or consequential damages, or limitations on how long an implied warranty lasts, so the foregoing limitations and exclusions may not apply. This Limited Warranty provides specific legal rights and you may also have other rights which vary from state to state.

Trademarks:

D-Link is a registered trademark of D-Link Corporation/D-Link Systems, Inc. Other trademarks or registered trademarks are the property of their respective owners.

Copyright Statement:

No part of this publication or documentation accompanying this product may be reproduced in any form or by any means or used to make any derivative such as translation, transformation, or adaptation without permission from D-Link Corporation/D-Link Systems, Inc., as stipulated by the United States Copyright Act of 1976 and any amendments thereto. Contents are subject to change without prior notice.

Copyright ©2016 by D-Link Corporation/D-Link Systems, Inc. All rights reserved.

CE Mark Warning:

This is a Class B product. In a domestic environment, this product may cause radio interference, in which case the user may be required to take adequate measures.

FCC Statement:

This equipment has been tested and found to comply with the limits for a Class B digital device, pursuant to Part 15 of the FCC Rules. These limits are designed to provide reasonable protection against harmful interference in a residential installation. This equipment generates, uses and can radiate radio frequency energy and, if not installed and used in accordance with the instructions, may cause harmful interference to radio communications. However, there is no guarantee that interference will not occur in a particular installation. If this equipment does cause harmful interference to radio or television reception, which can be determined by turning the equipment off and on, the user is encouraged to try to correct the interference by one of the following measures:

- Reorient or relocate the receiving antenna.
- Increase the separation between the equipment and receiver.
- Connect the equipment into an outlet on a circuit different from that to which the receiver is connected.
- Consult the dealer or an experienced radio/TV technician for help.

This device complies with Part 15 of the FCC Rules. Operation is subject to the following two conditions: (1) This device may not cause harmful interference, and (2) this device must accept any interference received, including interference that may cause undesired operation.

FCC Caution:

Any changes or modifications not expressly approved by the party responsible for compliance could void the user's authority to operate this equipment.

IMPORTANT NOTICE:**FCC Radiation Exposure Statement:**

This equipment complies with FCC radiation exposure limits set forth for an uncontrolled environment. This equipment should be installed and operated with minimum distance 20cm between the radiator & your body. To maintain compliance with FCC RF exposure compliance requirements, please avoid direct contact to the transmitting antenna during transmitting.

If this device is going to be operated in 5.15 ~ 5.25GHz frequency range, then it is restricted in indoor environment only. This transmitter must not be co-located or operating in conjunction with any other antenna or transmitter.

The availability of some specific channels and/or operational frequency bands are country dependent and are firmware programmed at the factory to match the intended destination. The firmware setting is not accessible by the end user.

ICC Notice:

Operation is subject to the following two conditions:

- 1) This device may not cause interference and
- 2) This device must accept any interference, including interference that may cause undesired operation of the device.

IMPORTANT NOTE:

IC Radiation Exposure Statement:

This equipment complies with IC radiation exposure limits set forth for an uncontrolled environment. End users must follow the specific operating instructions for satisfying RF exposure compliance. This equipment should be installed and operated with minimum distance 20cm between the radiator & your body.

This transmitter must not be co-located or operating in conjunction with any other antenna or transmitter.

- (i) The device for the band 5150-5250 MHz is only for indoor usage to reduce potential for harmful interference to co-channel mobile satellite systems;
- (ii) The maximum antenna gain (2dBi) permitted (for devices in the band 5725-5825 MHz) to comply with the e.i.r.p. limits specified for point-to-point and non point-to-point operation as appropriate, as stated in section A9.2(3).

In addition, users should also be cautioned to take note that high-power radars are allocated as primary users (meaning they have priority) of the bands 5250-5350 MHz and 5650-5850 MHz and these radars could cause interference and/or damage to LE-LAN devices.

Règlement d'Industry Canada

Les conditions de fonctionnement sont sujettes à deux conditions:

- (1) Ce périphérique ne doit pas causer d'interférence et.
- (2) Ce périphérique doit accepter toute interférence, y compris les interférences pouvant perturber le bon fonctionnement de ce périphérique.

Registration

Register your product online at registration.dlink.com



Product registration is entirely voluntary and failure to complete or return this form will not diminish your warranty rights.

Version 1.00
January 12