

# Wireless 802.11n ADSL2/2+ Modem Router

AR-7265WnA / AR-7265WnB

AR-7265WnM

User's Manual

Version 2.0 / May 2008



**EDIMAX**  
NETWORKING PEOPLE TOGETHER



Copyright© by Edimax Technology Co, LTD. all rights reserved. No part of this publication may be reproduced, transmitted, transcribed, stored in a retrieval system, or translated into any language or computer language, in any form or by any means, electronic, mechanical, magnetic, optical, chemical, manual or otherwise, without the prior written permission of this company

This company makes no representations or warranties, either expressed or implied, with respect to the contents hereof and specifically disclaims any warranties, merchantability or fitness for any particular purpose. Any software described in this manual is sold or licensed "as is". Should the programs prove defective following their purchase, the buyer (and not this company, its distributor, or its dealer) assumes the entire cost of all necessary servicing, repair, and any incidental or consequential damages resulting from any defect in the software. Further, this company reserves the right to revise this publication and to make changes from time to time in the contents hereof without obligation to notify any person of such revision or changes.

The product you have purchased and the setup screen may appear slightly different from those shown in this QIG. For more detailed information about this product, please refer to the User Manual on the CD-ROM. The software and specifications are subject to change without notice. Please visit our web site [www.edimax.com](http://www.edimax.com) for the update. All rights reserved including all brand and product names mentioned in this manual are trademarks and/or registered trademarks of their respective holders.

### Linux Open Source Code

Certain Edimax products include software code developed by third parties, software code is subject to the GNU General Public License ("GPL") or GNU Lesser General Public License ("LGPL"). Please see the **GNU** ([www.gnu.org](http://www.gnu.org)) and **LPGL** ([www.gnu.org](http://www.gnu.org)) Websites to view the terms of each license.

The GPL Code and LGPL Code used in Edimax products are distributed without any warranty and are subject to the copyrights of their authors. For details, see the GPL Code and LGPL Code licenses. You can download the firmware-files at <http://www.edimax.com> under "Download" page.

# Federal Communication Commission Interference Statement

## FCC Part 68

This equipment complies with Part 68 of the FCC Rules. On the bottom of this equipment is a label that contains the FCC Registration Number and Ringer Equivalence Number (REN) for this equipment. You must provide this information to the telephone company upon request.

The REN is useful to determine the quantity of devices you may connect to the telephone line and still have all of those devices ring when your number is called.

In most, but not all areas, the sum of the REN of all devices connected to one line should not exceed five (5.0). To be certain of the number of devices you may connect to your line, as determined by the REN, you should contact your local telephone company to determine the maximum REN for your calling area.

If the modem causes harm to the telephone network, the telephone company may discontinue your service temporarily. If possible, they will notify you in advance.

But if advance notice isn't practical, you will be notified as soon as possible. You will be advised of your right to file a complaint with the FCC.

The telephone company may make changes in its facilities, equipment, operations, or procedures that could affect the proper operation of your equipment.

If they do, you will be notified in advance to give you an opportunity to maintain uninterrupted telephone service.

If you experience trouble with this modem, please contact your dealer for repair/warranty information. The telephone company may ask you to disconnect

---

this equipment from the network until the problem has been corrected or you are sure that the equipment is not malfunctioning.

This equipment may not be used on coin service provided by the telephone company. Connection to party lines is subject to state tariffs.

### **Installation**

This device is equipped with a USOC RJ11C connector.

### **FCC Part 15**

This equipment has been tested and found to comply with the limits for a Class B digital device, pursuant to Part 15 of FCC Rules. These limits are designed to provide reasonable protection against harmful interference in a residential installation. This equipment generates, uses, and can radiate radio frequency energy and, if not installed and used in accordance with the instructions, may cause harmful interference to radio communications. However, there is no guarantee that interference will not occur in a particular installation. If this equipment does cause harmful interference to radio or television reception, which can be determined by turning the equipment off and on, the user is encouraged to try to correct the interference by one or more of the following measures:

1. Reorient or relocate the receiving antenna.
  2. Increase the separation between the equipment and receiver.
  3. Connect the equipment into an outlet on a circuit different from that to which the receiver is connected.
  4. Consult the dealer or an experienced radio technician for help.
-

### **FCC Caution**

This equipment must be installed and operated in accordance with provided instructions and a minimum 20 cm spacing must be provided between computer mounted antenna and person's body (excluding extremities of hands, wrist and feet) during wireless modes of operation.

This device complies with Part 15 of the FCC Rules. Operation is subject to the following two conditions: (1) this device may not cause harmful interference, and (2) this device must accept any interference received, including interference that may cause undesired operation.

Any changes or modifications not expressly approved by the party responsible for compliance could void the authority to operate equipment.

### **Federal Communication Commission (FCC) Radiation Exposure Statement**

This equipment complies with FCC radiation exposure set forth for an uncontrolled environment. In order to avoid the possibility of exceeding the FCC radio frequency exposure limits, human proximity to the antenna shall not be less than 20cm (8 inches) during normal operation.

The antenna(s) used for this transmitter must not be co-located or operating in conjunction with any other antenna or transmitter.

---

## **R&TTE Compliance Statement**

This equipment complies with all the requirements of DIRECTIVE 1999/5/EC OF THE EUROPEAN PARLIAMENT AND THE COUNCIL of March 9, 1999 on radio equipment and telecommunication terminal Equipment and the mutual recognition of their conformity (R&TTE).

The R&TTE Directive repeals and replaces in the directive 98/13/EEC (Telecommunications Terminal Equipment and Satellite Earth Station Equipment) As of April 8, 2000.

### **Safety**

This equipment is designed with the utmost care for the safety of those who install and use it. However, special attention must be paid to the dangers of electric shock and static electricity when working with electrical equipment. All guidelines of this and of the computer manufacture must therefore be allowed at all times to ensure the safe use of the equipment.

### **EU Countries Intended for Use**

The ETSI version of this device is intended for home and office use in Austria, Belgium, Denmark, Finland, France, Germany, Greece, Ireland, Italy, Luxembourg, Bulgaria, Cyprus, Czech Republic, Estonia, Hungary, Latvia, Lithuania, Malta, Poland, Romania, Slovakia, Slovenia, the Netherlands, Portugal, Spain, Sweden, and the United Kingdom.

The ETSI version of this device is also authorized for use in EFTA member states: Iceland, Liechtenstein, Norway, and Switzerland.

### **EU Countries Not intended for use**

None.

---

# Contents

<b>1. INTRODUCTION .....</b>	<b>1</b>
1.1. FEATURES .....	2
1.2. MINIMUM REQUIREMENTS .....	3
1.3. PACKAGE CONTENT .....	3
1.4. HARDWARE PLACEMENT .....	4
1.4.1. <i>Rear Panel</i> .....	4
1.4.2. <i>Front LEDs</i> .....	5
<b>2. HARDWARE INSTALLATION .....</b>	<b>7</b>
<b>3. SETUP WIZARD .....</b>	<b>8</b>
<b>4. IP ADDRESS SETTING.....</b>	<b>12</b>
<b>5. WEB MANAGEMENT CONFIGURATION.....</b>	<b>18</b>
5.1. QUICK START .....	20
5.2. INTERFACE SETUP .....	25
5.2.1. <i>Internet</i> .....	25
5.2.2. <i>LAN</i> .....	30
5.2.3. <i>Wireless</i> .....	33
5.3. ADVANCED SETUP .....	38
5.3.1. <i>Firewall</i> .....	38
5.3.2. <i>Routing</i> .....	39
5.3.3. <i>NAT</i> .....	41
5.3.3.1. NAT .....	41
5.3.3.2. DMZ.....	42
5.3.3.3. Virtual Server.....	42
5.3.4. <i>ADSL</i> .....	44
5.4. ACCESS MANAGEMENT.....	45
5.4.1. <i>ACL</i> .....	45
5.4.2. <i>IP Filter</i> .....	46
5.4.2.1. IP/MAC Filter .....	47

---

5.4.2.2.	Application Filter .....	49
5.4.2.3.	URL Filter .....	50
5.4.3.	<i>SNMP</i> .....	51
5.4.4.	<i>UPnP</i> .....	52
5.4.5.	<i>DDNS</i> .....	53
5.5.	MAINTENANCE .....	54
5.5.1.	<i>Administrator</i> .....	54
5.5.2.	<i>Time Zone</i> .....	55
5.5.3.	<i>Firmware</i> .....	56
5.5.4.	<i>System Restart</i> .....	57
5.5.5.	<i>Diagnostics</i> .....	57
5.6.	STATUS .....	58
5.6.1.	<i>Device Info</i> .....	58
5.6.2.	<i>System Log</i> .....	59
5.6.3.	<i>Statistics</i> .....	60
<b>6.</b>	<b>TROUBLESHOOTING .....</b>	<b>61</b>
<b>7.</b>	<b>GLOSSARY .....</b>	<b>65</b>

---



# 1. Introduction

Congratulations on purchasing Edimax AR-7265WnA or B Wireless 11n ADSL2+ Modem Router. This router is a cost-effective ADSL2+ router, with the combination of an ADSL2+ modem, router, Ethernet network switch and wireless access point, you can surf the Internet through your ADSL2/2+ broadband connection without investing other devices.

This router can support downstream transmission rates of up to 24Mbps and upstream transmission rates of up to 1Mbps. It supports PPPoA (RFC 2364 - PPP over ATM Adaptation Layer 5), RFC 1483/2684 encapsulation over ATM (bridged or routed) and PPP over Ethernet (RFC 2516) to establish a connection with ISP. The product also supports VC-based and LLC-based multiplexing.

With the web management interface, users can easily configure the various functions of the router including DHCP server, NAT, virtual server, DMZ, access control, IP/MAC/Application/URL filter, Firewall, PPTP/IPSec/L2TP pass-through, DDNS, UPnP, Wireless and etc.

This router is a high performance and high-speed device that provides a full rate of ADSL2+ standard with the superb reliability and a complete solution for home and office application.

## 1.1. Features

### ADSL2/2+ Compliance

- Support downstream rates of up to 24Mbps and upstream rates of up to 1Mbps.
- Compliant to ITU-T G.992.1 (G.dmt), G.992.2 (G.lite), G.992.3 (ADSL2), G.992.4 (splitterless ADSL2), G.992.5 (ADSL2+) for Annex A, B. (Annex A and B are supported in different H/W platform)
- Supports Multi-Mode standard (ANSI T1.413, Issue 2; G.dmt (G.992.1); G.994.1 and G.996.1 (for ISDN only); G.991.1;G.lite (G992.2)).
- Multiple Protocols over AAL5 (RFC 1483/2684).
- PPP over AAL5 (RFC 2364).
- PPP over Ethernet (RFC 2516).

### Support 300Mbps 802.11n Wireless Access Point

- Complies with IEEE 802.11n and 802.11g/b standard.
- High data rate – up to 300Mbps network speed.
- Supports 64-bit/128-bit WEP, WPA-PSK and WPA2-PSK wireless security functions.
- Support Auto Channel Selection.
- Supports MAC address filtering.

### Router

- NAT (Network Address Translation) IP Sharing
- Virtual Server
- DMZ
- VPN Pass Through (IPSec/PPTP/L2TP)
- SPI Anti-DOS Firewall
- DHCP Server and Client

### Access Management

- ACL (Access Control)
  - IP/MAC/Application/URL Filter
  - UPnP (Universal Plug and Play)
  - SNMP
  - Dynamic DNS
-

## 1.2. Minimum Requirements

The following devices are necessary to configure and use the ADSL2+ Router :

- A PC with Pre-installed Ethernet Adapter (Required) and a Web-Browser (Internet Explorer 4.0 or higher)
- RJ-45 Ethernet crossover cable (Included in the package)
- RJ-11 (ADSL Ready) phone Line

## 1.3. Package Content

- One ADSL2/2+ Router (Annex A or B)
- 3dBi Antennas x 3
- One 12V Power Adapter
- One RJ-45 Ethernet Cable (100 cm)
- One RJ-11 Telephone Line (180 cm)
- One Quick Installation Guide
- One CD with Setup Wizard ,Multi-languages QIG and User Manual
- Holding Base

### Notice :

To improve wireless signal reception, please arrange the antennas as the picture shown below (horizontal or vertical installation), and place the wireless access point in open space. Please keep the distance between antennas, if the antennas are too close to each other, wireless signal reception will be affected.

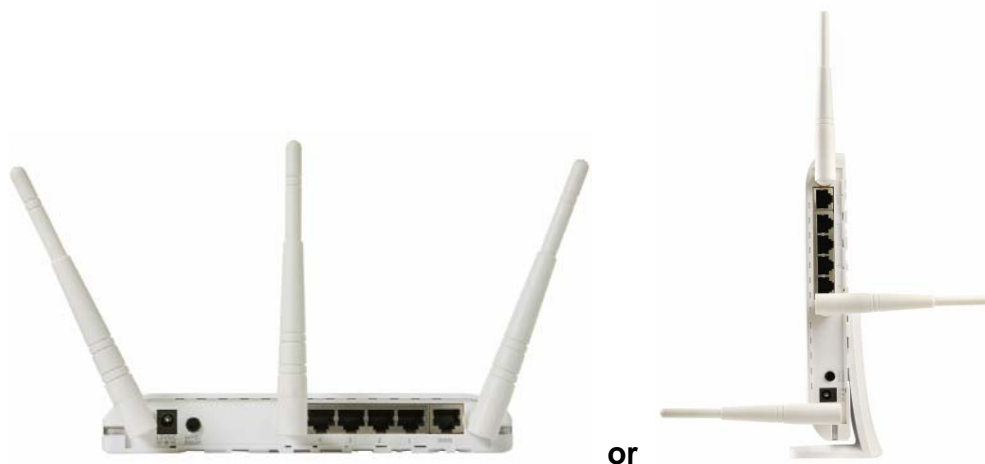

## 1.4. Hardware Placement

### 1.4.1. Rear Panel

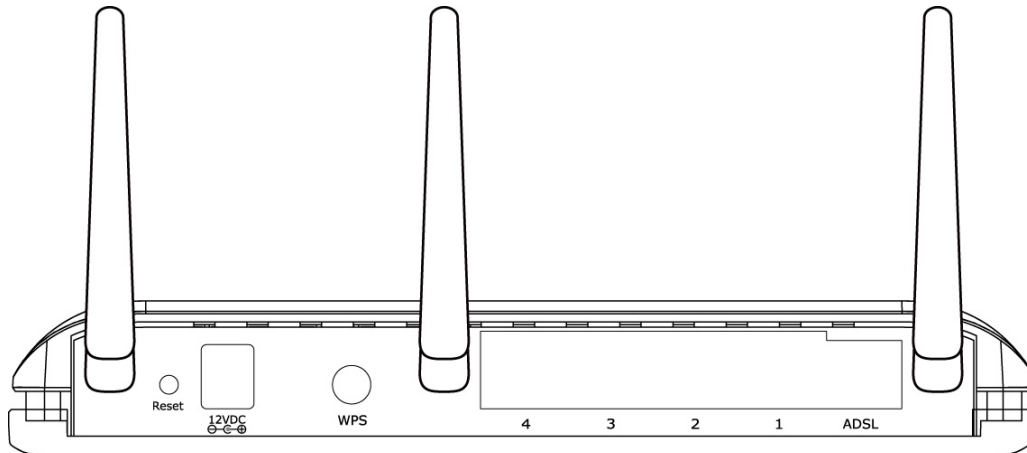

#### 1) Antenna Connectors

The antenna connector of the router is reverse SMA connector. It allows you to connecting an external antenna with reverse SMA connector to the router easily.

#### 2) Reset

The Reset button can be used to reset the router or restore to factory defaults.

- If problems occur with your router, power it on and press the router's reset button with a pencil tip (for less than 3 seconds) and the router will reboot and , keeping all your current settings.
- If problems persisted or you forgot your router's password, press the reset button for 5 seconds with power on. The router will reset to the factory default settings. (**Warning** : all your current settings will be lost and replaced by the factory default settings)

### 3) WPS

Wi-Fi Protected Setup (WPS) is the simplest way to build connection between wireless network clients and this ADSL router. Press this button on the router and enable WPS function of the wireless clients, the router and clients will automatically configure the security key and connect directly. Please note that the router will wait for WPS requests from wireless clients in 2 minutes after the WPS button is pressed.

### 4) Power Jack

Please plug the power adapter attached with the ADSL Router to the power jack. The power adapter is 12V.

### 5) Local Area Network (LAN)

The router's 4 LAN ports are where you connect your LAN's PCs, printer servers, hubs and switches etc.



### 6) ADSL

Connect the supplied RJ-11 telephone line to this port and your ADSL/telephone network.

## 1.4.2. Front LEDs

On the router's front panel there are LED lights that inform you of the router's current status. Below is an explanation of each LED and its description.



LED	Light Status	Description
PWR (Green) 	On	The router is ready
WLAN (Yellow) 	Off	Wireless LAN is disabled
	Blinking	Wireless traffic is transmitting or receiving
WPS (Yellow) 	Off	WPS function is disabled
	Blinking	WPS function is enabled
ADSL (Green)	On	Connected to an ADSL DSLAN successfully

	Blinking	No connection
LAN LNK/ACT (Port 1-4)	On	The LAN cable is connected to the router
	Off	No network connection.
	Blinking	Network traffic transferring or receiving through the LAN port

## 2. Hardware Installation

### Step 1. Connect the ADSL Line

Use the supplied RJ-11 telephone cable, connect the router from the ADSL port to your telephone socket with an ADSL micro filter plugged in.

### Step 2. Connect the router to your LAN network

Connect the router to your PC, hub or switch by attached the Ethernet cable to the LAN port of the router.

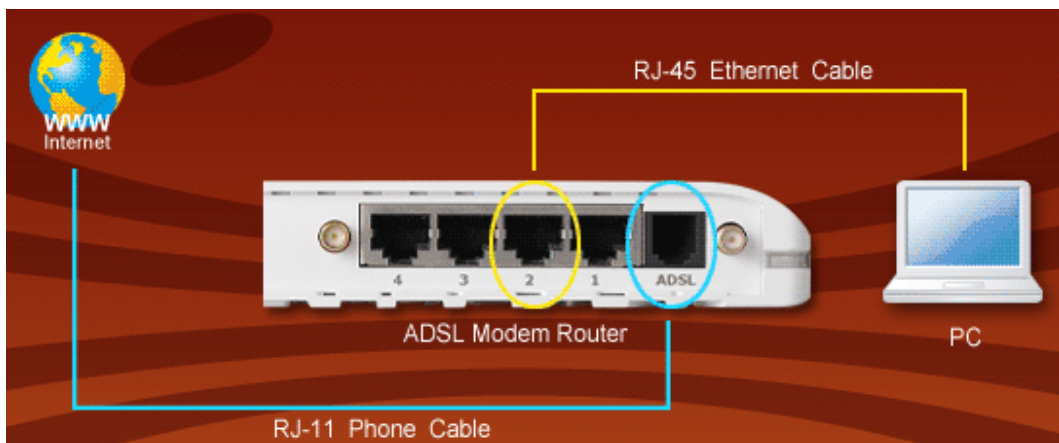

### Step 3. Connect the Power Adapter to the Router

Connect the power adapter to the power jack on the rear panel of the router and switch on the power.

### Step 4. Check the ADSL LED light status

Please check the ADSL LED on the front panel. This light indicates the status of your ADSL broadband through your telephone line. If the light is on solid, you can continue the setup. However, if the light is flashing, there is no broadband line being detected. Therefore, please call your Internet Service Provider (ISP) and inform them about the flashing ADSL light.

### Step 5. Firewall settings.

Please turn off all personal firewall before you continue the setup as they might block the communication of your PC and the router.

**Note :** You must use the power adapter shipped along with the router, do **NOT** use any other power adapter from other sources.

### 3. Setup Wizard

You can configure the router by running the Setup Wizard in the CD-ROM provided in the package. The wizard provides quick setup for the Internet connection, SSID, wireless security, firmware upgrade and changing router's password. When you start the Setup Wizard, you will get the following Welcome screen. Please choose the language to start with and follow the easy steps in the Wizard. No instruction for the Setup Wizard is given here.

If you lost the CD-ROM or you prefer the traditional web setup, please follow the procedures of chapter 4 and chapter 5 to configure the router.

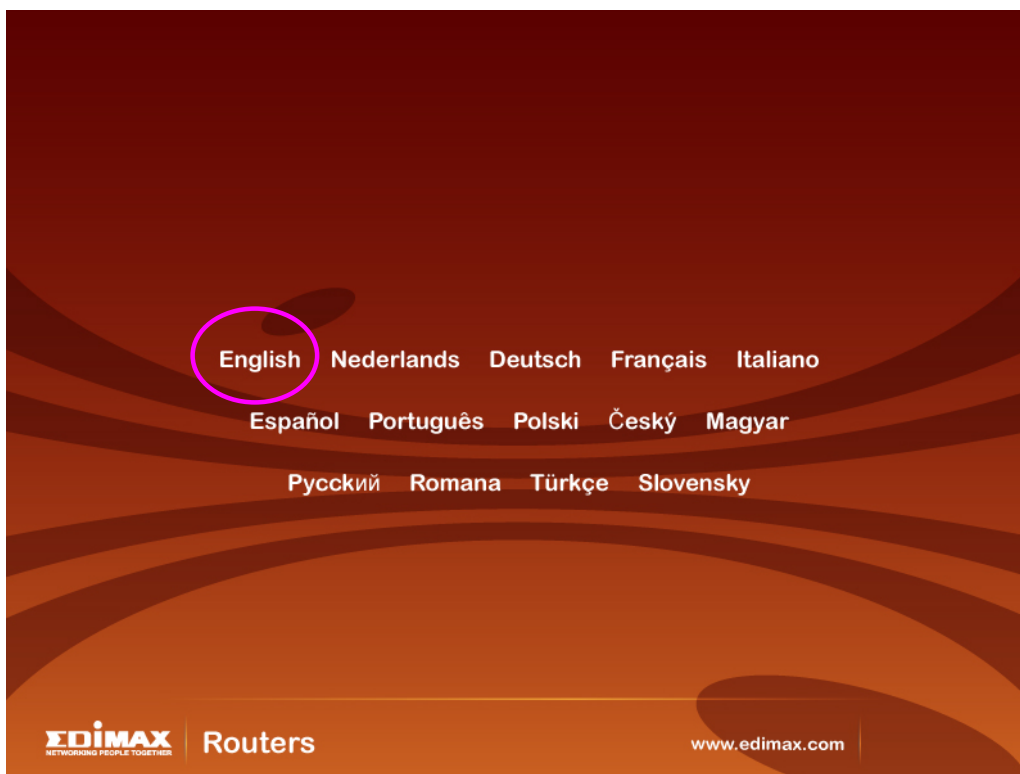

The wizard will guide you to setup “ Internet Connection” , “ ESSID “ , Wireless security “ and “ Firmware Upgrade “ .





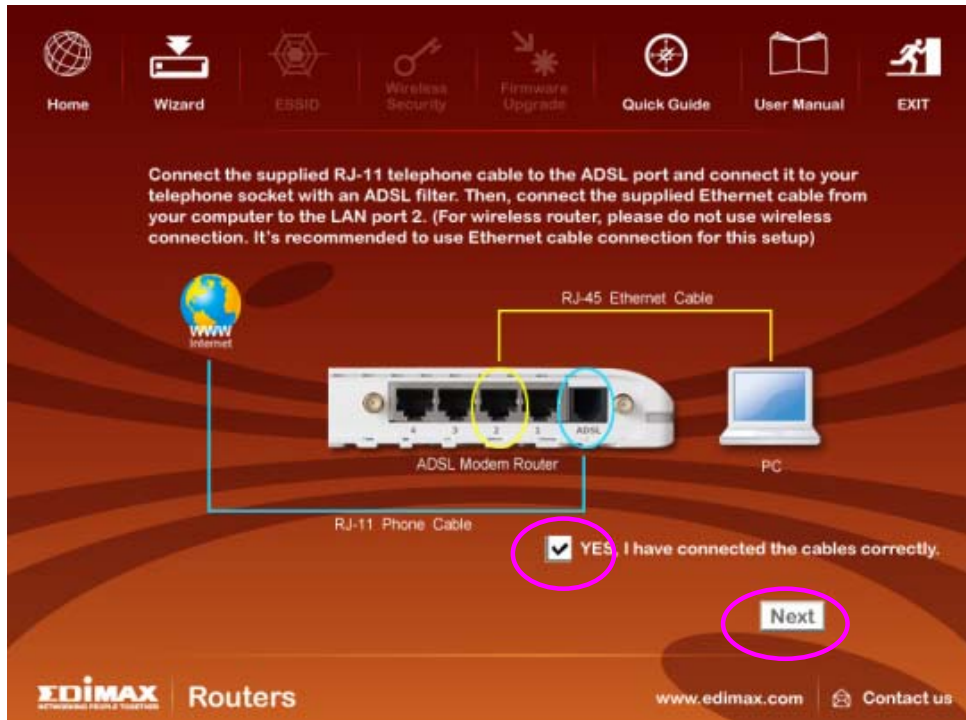

Please choose the product type which you bought .

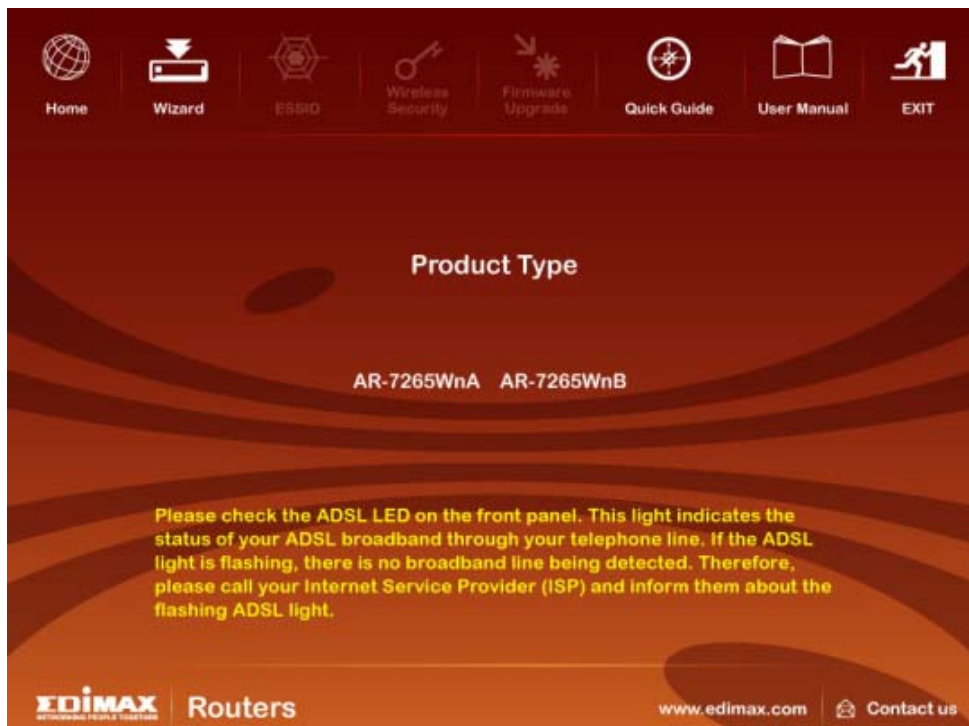

The default password is “ 1234 “ .



The screenshot shows the 'Configuring' step of the Edimax router setup. At the top, there is a navigation menu with icons for Home, Wizard, ESSID, Wireless Security, Firmware Upgrade, Quick Guide, User Manual, and EXIT. The main heading is 'Configuring'. Below it, a message states: 'Login to your router. Default Password is 1234. You can change this password to avoid unauthorized access to your router. (Please note that this is not the Internet connection password)'. There are three input fields: 'Current Password:', 'New Password:', and 'Confirmed Password:'. A yellow note reads: 'NOTE: If you forget your router's password, reset the router back to factory default settings. To reset, power on the router, then press the Reset button for 20 seconds.' An 'Apply' button is located at the bottom right. The footer includes the Edimax logo, 'Routers', the website 'www.edimax.com', and a 'Contact us' link.

Please select your country and ISP .If the country or ISP is not listed , please select “Others” from the list.



The screenshot shows the 'Internet Connection' step of the Edimax router setup. The navigation menu is the same as in the previous screenshot. The main heading is 'Internet Connection'. Below it, a message states: 'Select your country and ISP. If the country or ISP is not listed, please select "Others" from the list.' There are two input fields: 'Country:' and 'ISP:'. A 'Next' button is located at the bottom right. The footer includes the Edimax logo, 'Routers', the website 'www.edimax.com', and a 'Contact us' link.

Click” Next “ to finish all configurations of Internet Connection , Wireless setting and Firmware Upgrade .

## 4. IP Address Setting

If you lost the CD-ROM or you prefer the traditional web setup, please follow the procedures of chapter 4 and chapter 5 to configure the router. Using the router to get into the Internet, the PCs in the network must have Ethernet adapter installed and be connected to the router either directly or through a hub or switch. The TCP/IP protocol of each PC has to be installed and the IP Address of each PC has to be set in the same subnet as the router.

The router's default IP Address is **192.168.2.1** and the subnet mask is **255.255.255.0**. PCs can be configured to obtain IP Address automatically through the DHCP Server of the router or a fixed IP Address in order to be in the same subnet as the router. By default, the DHCP Server of the router is enabled and will dispatch IP Address to PC from **192.168.2.100** to **192.168.2.200**. It is strongly recommended to set obtaining IP address automatically.

This section shows you how to configure your PC's so that it can obtain an IP address automatically for either Windows 95/98/Me, 2000 or NT operating systems. For other operating systems (Macintosh, Sun, etc.), please follow the manual of the operating systems. The following is a step-by-step illustration on how to configure your PC to obtain an IP address automatically for **Windows XP**, **Windows 2000**, **Windows 95/98/Me**, and **Windows NT**.

### Windows XP

1. Click the *Start* button and select *Control Panel* and then double click *Network Connections*. The *Network Connections* window will appear.
2. Right click on the *Local Area Connection* icon and select *Properties*. The *Local Area Connection* window will appear.
3. Check your list of Network Components. You should see Internet Protocol [TCP/IP] on your list. Select it and click the *Properties* button.

4. In the Internet Protocol (TCP/IP) Properties window, select *Obtain an IP address automatically* and *Obtain DNS server address automatically* as shown on the following screen.

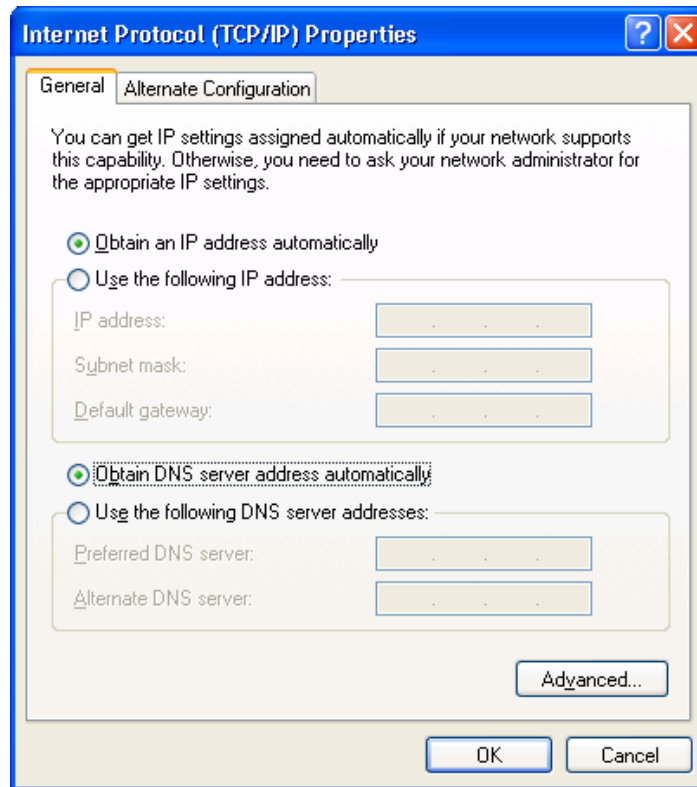

5. Click *OK* to confirm the setting. Your PC will now obtain an IP address automatically from your router's DHCP server.

**Note: Please make sure that the router's DHCP server is the only DHCP server available on your LAN.**

## Windows 2000

1. Click the *Start* button and select *Settings*, then click *Control Panel*. The *Control Panel* window will appear.
2. Double-click *Network and Dial-up Connections* icon. In the *Network and Dial-up Connection* window, double-click *Local Area Connection* icon. The *Local Area Connection* window will appear.
3. In the *Local Area Connection* window, click the *Properties* button.
4. Check your list of *Network Components*. You should see *Internet Protocol [TCP/IP]* on your list. Select it and click the *Properties* button.
5. In the *Internet Protocol (TCP/IP) Properties* window, select *Obtain an IP address automatically* and *Obtain DNS server address automatically* as shown on the following screen.

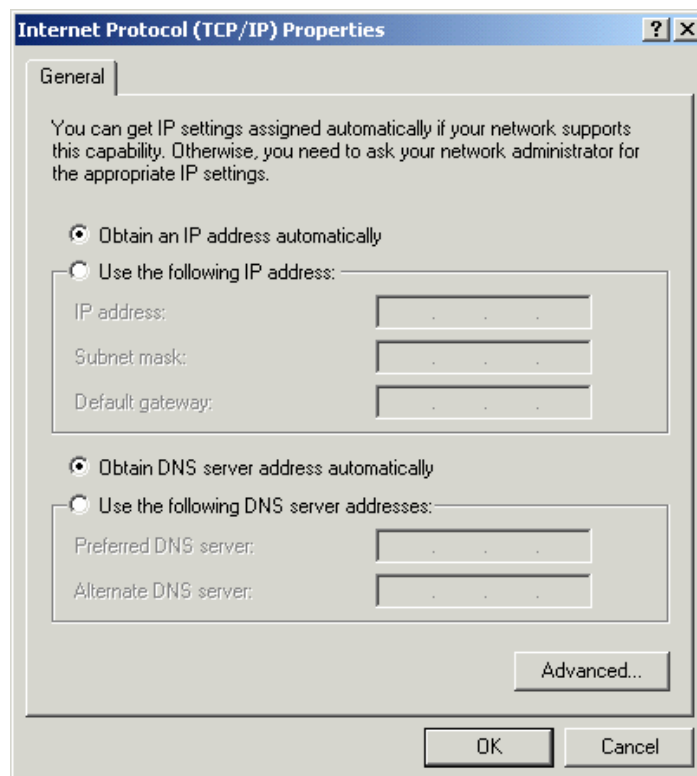

6. Click *OK* to confirm the setting. Your PC will now obtain an IP address automatically from your Broadband Router's DHCP server.

**Note: Please make sure that the router's DHCP server is the only DHCP server available on your LAN.**

### **Windows 95/98/Me**

1. Click the *Start* button and select *Settings*, then click *Control Panel*. The *Control Panel* window will appear.
  2. Double-click *Network* icon. The *Network* window will appear.
  3. Check your list of Network Components. If TCP/IP is not installed, click the *Add* button to install it now. If TCP/IP is installed, go to step 6.
  4. In the Network Component Type dialog box, select *Protocol* and click *Add* button.
  5. In the Select Network Protocol dialog box, select *Microsoft and TCP/IP* and then click the *OK* button to start installing the TCP/IP protocol. You may need your Windows CD to complete the installation.
  6. After installing TCP/IP, go back to the Network dialog box. Select *TCP/IP* from the list of Network Components and then click the *Properties* button.
  7. Check each of the tabs and verify the following settings:
    - Bindings:** Check Client for Microsoft Networks and File and printer sharing for Microsoft Networks.
    - Gateway:** All fields are blank.
    - DNS Configuration:** Select Disable DNS.
    - WINS Configuration:** Select Disable WINS Resolution.
    - IP Address:** Select Obtain IP address automatically.
-

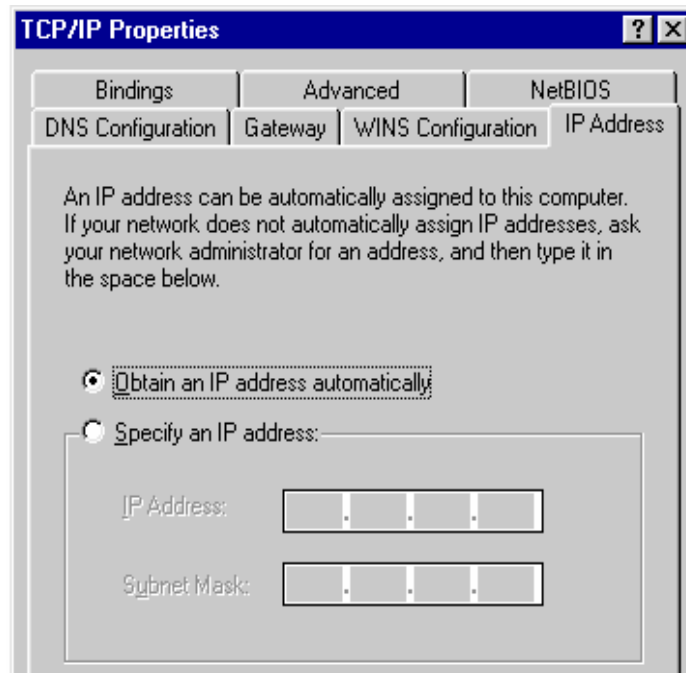

8. Reboot the PC. Your PC will now obtain an IP address automatically from your router's DHCP server.

**Note: Please make sure that the router's DHCP server is the only DHCP server available on your LAN.**

### Windows NT

1. Click the *Start* button and select *Settings*, then click *Control Panel*. The Control Panel window will appear.
2. Double-click *Network* icon. The *Network* window will appear. Select the *Protocol* tab from the *Network* window.
3. Check if the *TCP/IP Protocol* is on your list of *Network Protocols*. If TCP/IP is not installed, click the *Add* button to install it now. If TCP/IP is installed, go to step 5.
4. In the *Select Network Protocol* window, select the *TCP/IP Protocol* and click the *Ok* button to start installing the TCP/IP protocol. You may need your Windows CD to complete the installation.



5. After you install TCP/IP, go back to the *Network* window. Select *TCP/IP* from the list of *Network Protocols* and then click the *Properties* button.
6. Check each of the tabs and verify the following settings:
  - IP Address:** Select Obtain an IP address from a DHCP server.
  - DNS:** Let all fields are blank.
  - WINS:** Let all fields are blank.
  - Routing:** Let all fields are blank.

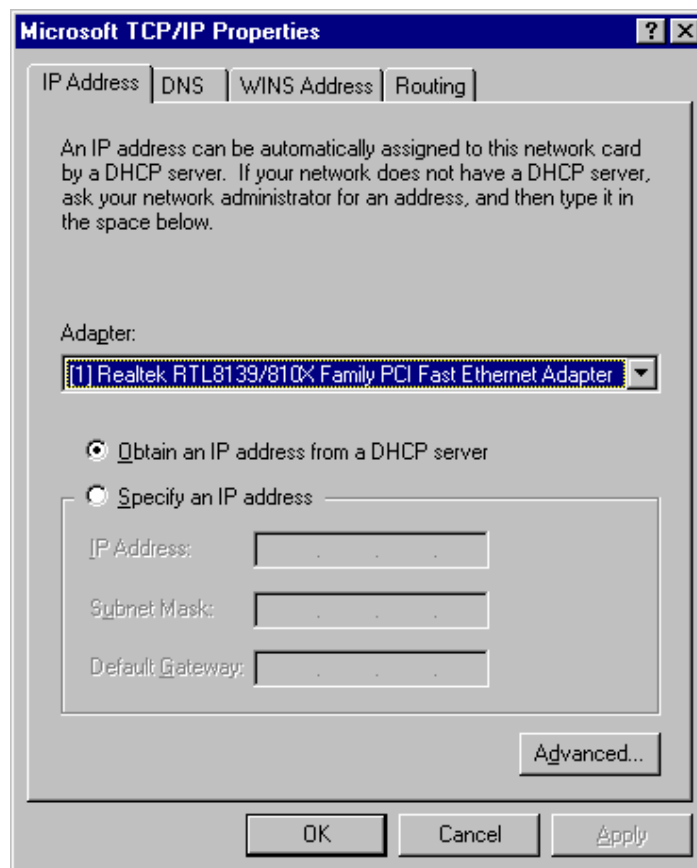

7. Click OK to confirm the setting. Your PC will now obtain an IP address automatically from your Broadband Router's DHCP server.

**Note:** Please make sure that the router's DHCP server is the only DHCP server available on your LAN.

## 5. Web Management Configuration

Once you have configured your PCs to obtain an IP address automatically, the router's DHCP server will automatically give your LAN clients an IP address. By default the router's DHCP server is enabled so that you can obtain an IP address automatically. To see if you have obtained an IP address, see Appendix A.

Once your PC has obtained an IP address from your router, enter the default IP address **192.168.2.1** (router's IP address) into your PC's web browser and press <enter>



The login screen below will appear. Enter the "User Name" and "Password" and then click <OK> to login. By default the user name is "**admin**" and the password is "**1234**". For security reasons it is recommended that you change the password as soon as possible.



The **HOME** page screen below will appear. The **Home** Page is divided into seven sections: **Quick Start, Interface Setup, Advanced Setup, Access Management, Maintenance, Status and Help.**

**EDIMAX**  
NETWORKING PEOPLE TOGETHER

ADSL Router

Status	Quick Start	Interface Setup	Advanced Setup	Access Management	Maintenance	Status	Help
<a href="#">Device Info</a>   <a href="#">System Log</a>   <a href="#">Statistics</a>							
<b>Device Information</b>	Firmware Version : 2.11.32.0(NRE0.C29)3.9.9.5 MAC Address : 00:aa:bb:01:23:45						
<b>LAN</b>	IP Address : 192.168.2.1 Subnet Mask : 255.255.255.0 DHCP Server : Enabled						
<b>WAN</b>	Virtual Circuit : <input type="text" value="PVC0"/> Status : Not Connected Connection Type : Dynamic IP IP Address : 0.0.0.0 Subnet Mask : 0.0.0.0 Default Gateway : 0.0.0.0 DNS Server : 0.0.0.0 NAT : Enabled						
<b>ADSL</b>	ADSL Firmware Version : FwVer:3.9.9.5_TC3085 HwVer:T14.F7_3.0 Line State : Down Modulation : N/A Annex Mode : N/A						
				Downstream	Upstream		

### **Quick Start** (Section 5.1)

Follow the setup process in the Quick Start, you can quickly set the router as an Internet Access device.

### **Interface Setup** (Section 5.2)

It allows you to configure the Internet, LAN and Wireless access

### **Advanced Setup** (Section 5.3)

This section contains configurations for the router's advanced functions such as Firewall, Virtual Server, DMZ, ADSL Mode, ADSL Type, etc.

### **Access Management** (Section 5.4)

It allows you to configure ACL, IP Filter, SNMP, UPnP and DDNS functions.

### **Maintenance** (Section 5.5)

If you want to change the administrator's password, restart the router, update the firmware, diagnose the connection or change the Time Zone of the router, please select this menu.

### **Status** (Section 5.6)

The router's setup information, system log and some statistics can be viewed here.

### **Help**

If you want to know about the settings of the router quickly, please refer to the description in the Help menu.

## **5.1. Quick Start**

The Quick Start section is designed to get you using the router as quickly as possible. Before configuring the router, please check with your ISP (Internet Service Provider) what kind of the service is provided such as PPPoE, PPPoA or RFC1483/2684. Gather the information as illustrated in the following table and keep it for reference.

PPPoE	VPI/VCI, VC-based/LLC-based multiplexing, Username, Password (and Service Name).
PPPoA	VPI/VCI, VC-based/LLC-based multiplexing, Username, Password.
RFC1483 Bridged	VPI/VCI, VC-based/LLC-based multiplexing to use Bridged Mode.
RFC1483 Routed	VPI/VCI, VC-based/LLC-based multiplexing, IP Address, Subnet Mask, Gateway Address, and Domain Name System (DNS) IP Address (It is a fixed IP Address).

In the Quick Start, click “Run Wizard” to start the configuration.

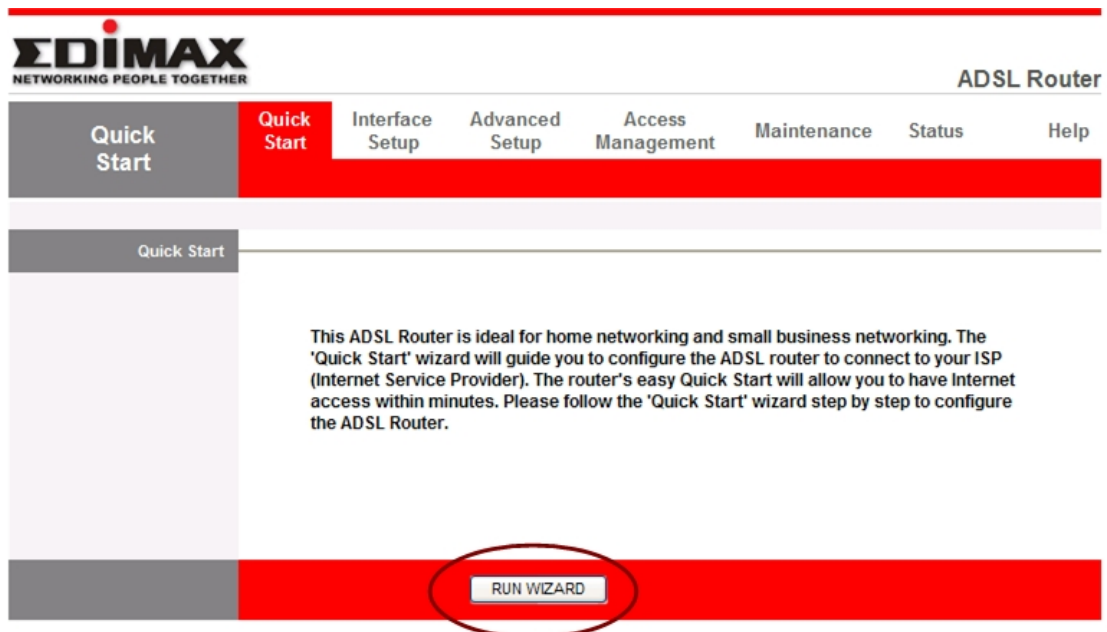

Please follow the steps in the setup wizard to complete the configuration of the Internet connection.



### Step 1: Set your new password

Please enter the new password and confirm the password again.



The screenshot shows a web browser window displaying the EDIMAX logo at the top, with the tagline "NETWORKING PEOPLE TOGETHER". Below the logo, the heading "Quick Start - Password" is followed by the instruction: "You may change the **admin** account password by entering in a new password. Click **NEXT** to continue." There are two input fields: "New Password:" and "Confirmed Password:". At the bottom right, there is a red bar containing three buttons: "BACK", "NEXT", and "EXIT".

### Step 2: Choose your time zone

Please select the time zone where you are located.

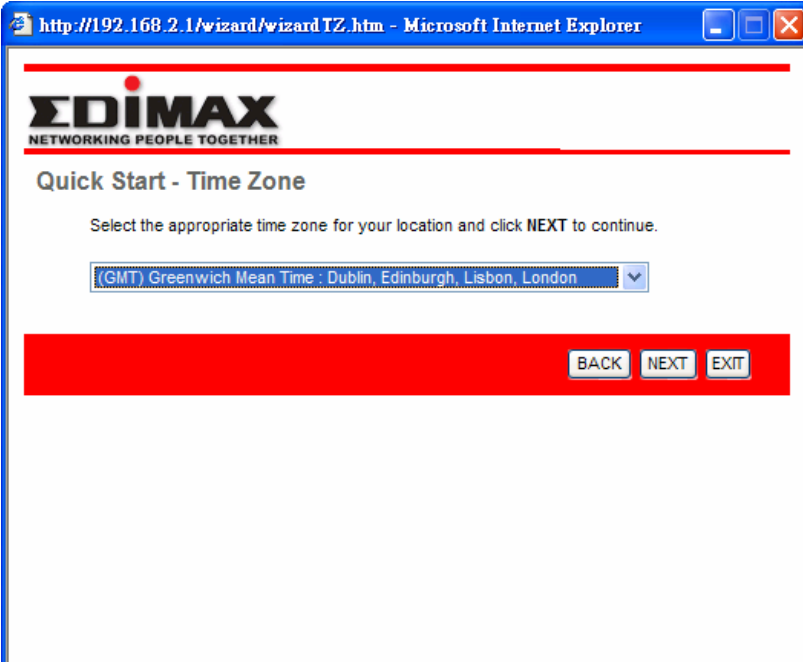

The screenshot shows a web browser window with the address bar displaying "http://192.168.2.1/wizard/wizardTZ.htm - Microsoft Internet Explorer". The EDIMAX logo and tagline "NETWORKING PEOPLE TOGETHER" are at the top. The heading "Quick Start - Time Zone" is followed by the instruction: "Select the appropriate time zone for your location and click **NEXT** to continue." Below this is a dropdown menu showing "(GMT) Greenwich Mean Time : Dublin, Edinburgh, Lisbon, London". At the bottom right, there is a red bar containing three buttons: "BACK", "NEXT", and "EXIT".

### Step 3: Set your Internet connection

Please check with your ISP the connection type of the ADSL line.

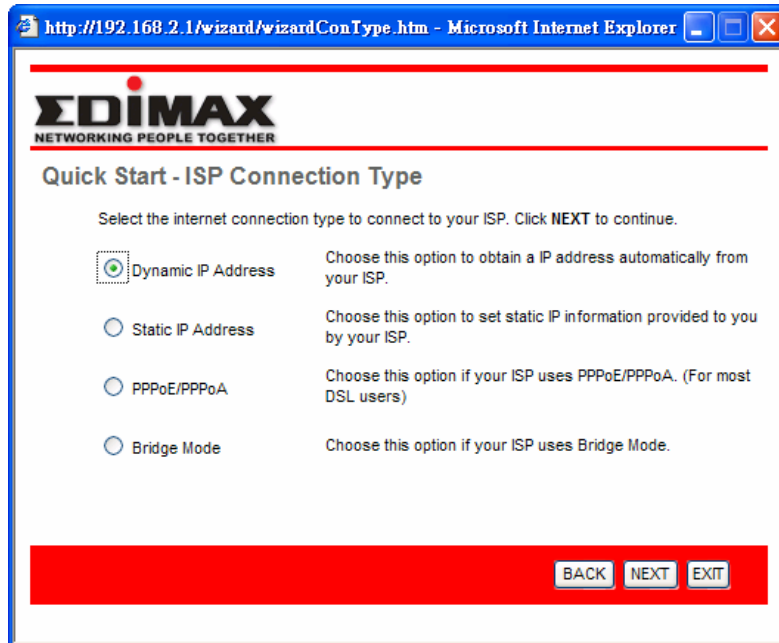

The screenshot shows a web browser window with the URL `http://192.168.2.1/wizard/wizardConType.htm`. The page features the EDIMAX logo and the title "Quick Start - ISP Connection Type". Below the title, there is a instruction: "Select the internet connection type to connect to your ISP. Click NEXT to continue." There are four radio button options: "Dynamic IP Address" (selected), "Static IP Address", "PPPoE/PPPoA", and "Bridge Mode". Each option has a brief description. At the bottom, there is a red bar containing "BACK", "NEXT", and "EXIT" buttons.

### Step 4: Input the data supplied by your ISP

To know more about the explanation of each setting, please refer to Section 5.2.

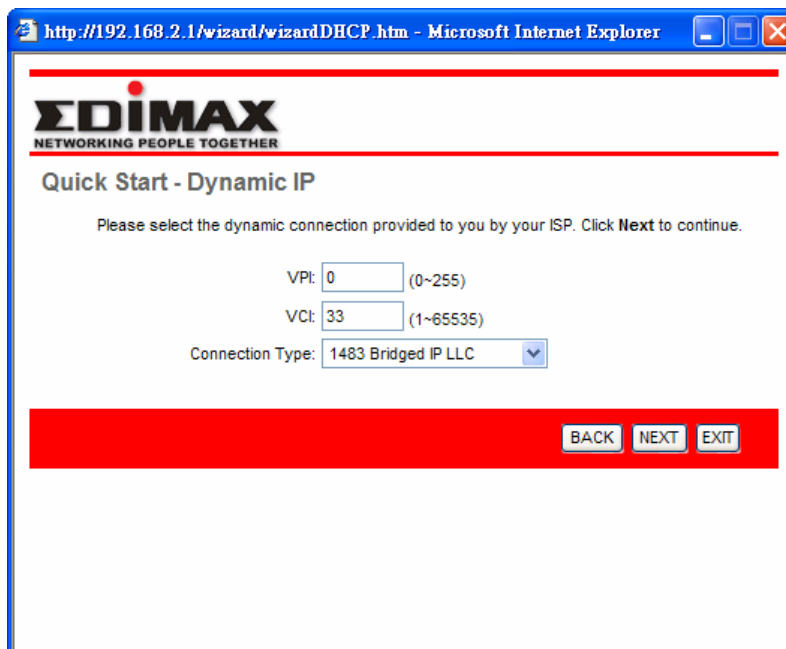

The screenshot shows a web browser window with the URL `http://192.168.2.1/wizard/wizardDHCP.htm`. The page features the EDIMAX logo and the title "Quick Start - Dynamic IP". Below the title, there is a instruction: "Please select the dynamic connection provided to you by your ISP. Click Next to continue." There are three input fields: "VPI:" with a value of "0" (range 0~255), "VCI:" with a value of "33" (range 1~65535), and "Connection Type:" with a dropdown menu showing "1483 Bridged IP LLC". At the bottom, there is a red bar containing "BACK", "NEXT", and "EXIT" buttons.

### Step 5: Re-start your ADSL router

Click "Next" to save the settings and restart the router.

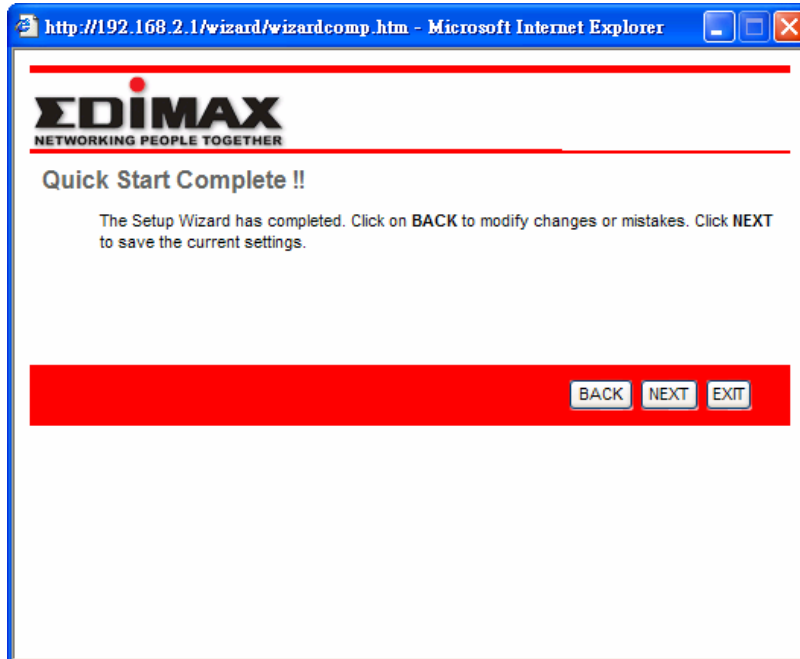



## 5.2. Interface Setup

### 5.2.1. Internet

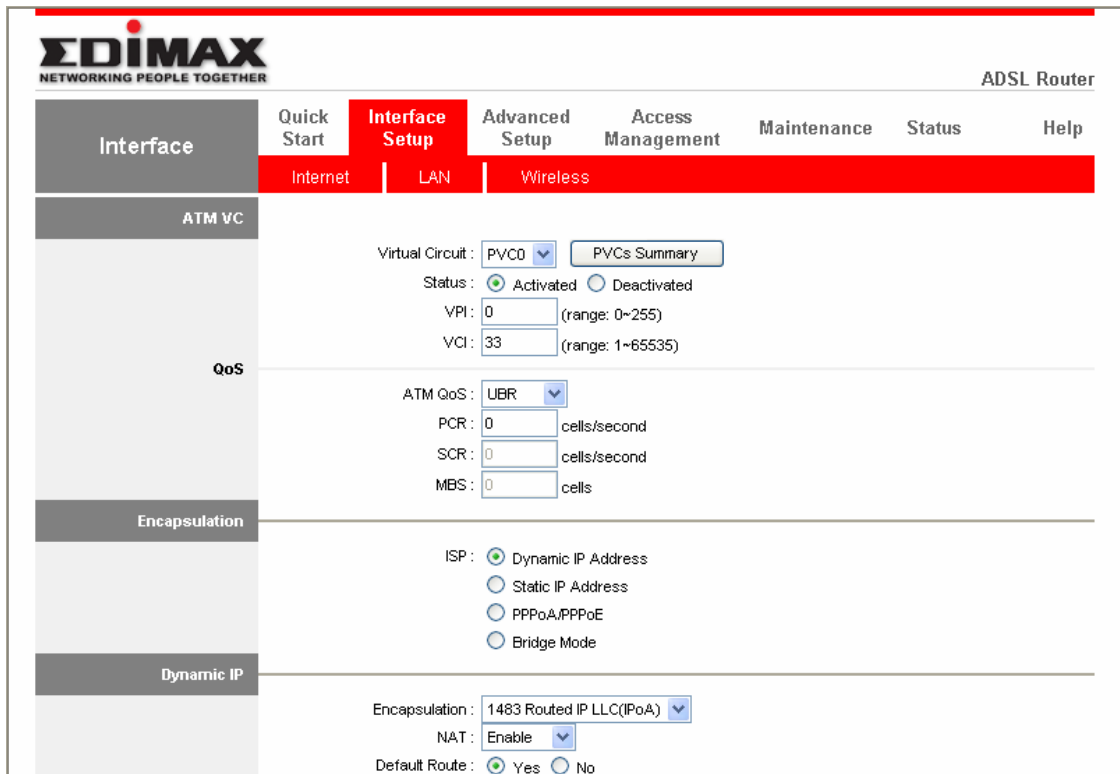

**EDIMAX**  
NETWORKING PEOPLE TOGETHER

ADSL Router

Interface | Quick Start | **Interface Setup** | Advanced Setup | Access Management | Maintenance | Status | Help

Internet | LAN | Wireless

ATM VC

Virtual Circuit: PVC0

Status:  Activated  Deactivated

VPI: 0 (range: 0~255)

VCI: 33 (range: 1~65535)

QoS

ATM QoS: LBR

PCR: 0 cells/second

SCR: 0 cells/second

MBS: 0 cells

Encapsulation

ISP:  Dynamic IP Address  
 Static IP Address  
 PPPoA/PPPoE  
 Bridge Mode

Dynamic IP

Encapsulation: 1483 Routed IP LLC(PoA)

NAT: Enable

Default Route:  Yes  No

- **ATM VC**

Parameter	Description
Virtual Circuit	VPI (Virtual Path Identifier) and VCI (Virtual Channel Identifier) define a virtual circuit.
VPI	VPI is a virtual path determines the way an ATM cell should be routed. The VPI is an 8-bit (in UNI) or 12-bit (in NNI) number that is included in the header of an ATM cell. The valid range for the VPI is 0 to 255. Enter the VPI assigned by the ISP.

Parameter	Description
VCI	VCI is the label given to an ATM VC to identify it and determine its destination. The VCI is a 16-bit number that is included in the header of an ATM cell. The valid range for the VCI is 32 to 65535. Enter the VCI assigned by the ISP.
ATM QoS	<p>CBR (Constant Bit Rate) – This class is used for emulating circuit switching. The cell rate is constant with time. Select CBR to specify fixed (always on) bandwidth for voice or data traffic.</p> <p>UBR (Unspecified Bit Rate) – Select UBR for applications that are non-time sensitive, such as e-mail.</p> <p>rtVBR (real time Variable Bit Rate) – This class is similar to nrtVBR but is designed for applications that are sensitive to cell-delay variation. Examples for real-time VBR are voice with speech activity detection (SAD) and interactive compressed video.</p> <p>nrtVBR (non-real time Variable Bit Rate) – This class allows users to send traffic at a rate that varies with time depending on the availability of user information. Statistical multiplexing is provided to make optimum use of network resources. Multimedia e-mail is an example of nrtVBR.</p>
PCR	Divide the DSL line rate (bps) by 424 (the size of an ATM cell) to find the PCR (Peak Cell Rate). This is the maximum rate at which the sender can send cells.
SCR	SCR (Sustain Cell Rate) is the average rate, as measured over a long interval, in the order of the connection lifetime.

Parameter	Description
MBS	MBS (Maximum Burst Size) refers to the maximum number of cells that can be sent at the peak rate. Type the MBS, which is less than 65535.

- **Encapsulation**

The router can be connected to your service provider in any of the following ways.

Parameter	Description
Dynamic IP Address	Obtain an IP address automatically from your service provider.
Static IP Address	Uses a static IP address. Your service provider gives a static IP address to access Internet services.
PPPoE/PPPoA	PPPoE (PPP over Ethernet) and PPPoA (PPP over ATM) are common connection methods used for xDSL.
Bridge Mode	Bridge Mode is a common connection method used for xDSL modem.

- **Dynamic IP Address/Static IP Address/PPPoE/PPPoA/Bridge Mode**

After you have selected the ISP Type, this web page will be varied depending on the ISP Type you select. You have to continue setting some parameters. Please refer to the following table for the explanation of each parameter.

Parameter	Description
User Name	Enter the username exactly as your ISP assigned.
Password	Enter the password that your ISP has assigned to you.
Encapsulation	Please check with your ISP the method of multiplexing. In Bridge Mode, please select "1483 Bridge IP LLC" or "1483 Bridge IP VC-Mux". In PPPoE/PPPoA mode,

please select “PPPoE LLC”, “PPPoE VC-Mux”, “PPPoA LLC”, or “PPPoA VC-Mux”.

#### Bridge Interface

This router built-in ADSL modem is able to connect to ISP automatically. Alternatively, if you want to use the dial up software to manually connect to the ISP, you have to activate the “Bridge Interface”.

#### Connection

Always On – The connection will be kept always on. If the connection is interrupted, the router will re-connect automatically.

Connect On-Demand – Only connect when you want to surf the Internet. “Close if idle for xx minutes” is set to stop the connection when the network traffic is not sending or receiving after an idle time.

Connect Manually – After you have selected this option, please go to Status page. You will see the “Connect” button, click it and the router will connect to the ISP. If you want to stop the connection, please click “Disconnect” button.

#### TCP MSS Option

The “TCP MSS Option” enables the configuration of the maximum segment size (MSS) for transient packets that traverse a router, specifically TCP segments in the SYN bit set, when PPPoE is being used in the network. Please specify the MSS range from 100 to 1452 bytes or 0 byte as the default value.

---

Parameter	Description
Get IP Address	Choose Static or Dynamic IP Address. If Static IP is selected, please set the IP Address, Subnet Mask and Gateway obtained from your ISP.
Static IP Address	Enter the IP Address assigned by your ISP.
IP Subnet Mask	Enter the Subnet Mask assigned by your ISP.
Gateway	Enter the Gateway assigned by your ISP.
NAT	NAT (Network Address Translation), an Internet standard that enables a local-area network (LAN) to use one set of IP addresses for internal traffic and a second set of addresses for external traffic. When NAT is enabled, the router will help to make all necessary IP address translations for the PC connected to the router to access the Internet.
Default Route	When "Default Router" is enabled, all the packets for destinations not known by the router's routing table are sent to the default route. By default, it is enabled.
TCP MTU Option	MTU (Maximum Transmission Unit) determine the maximum size of each packet in any transmission within the network. Please specify the MTU range from 100 to 1500 bytes or 0 byte as the default value.
Dynamic Route	Dynamic routing allows routing tables in routers to change as the possible routes change. This router supports RIP1, RIP2-B and RIP2-M protocols for dynamic routing. After the RIP protocol is selected, please choose the RIP direction from "None", "Both", "IN Only" or "OUT Only".

Parameter	Description
Multicast	Specify the method of transmitting data simultaneously to many receivers. Please select “IGMP v1” or “IGMP v2” as the multicast protocol or select “Disabled” to disable the function.

## 5.2.2. LAN

The screenshot shows the EDIMAX ADSL Router web interface. The top navigation bar includes 'Quick Start', 'Interface Setup' (selected), 'Advanced Setup', 'Access Management', 'Maintenance', 'Status', and 'Help'. Under 'Interface Setup', there are sub-tabs for 'Internet', 'LAN' (selected), and 'Wireless'. The main content area is divided into three sections: 'Router Local IP', 'DHCP', and 'DNS'. The 'Router Local IP' section contains fields for IP Address (192.168.2.1), IP Subnet Mask (255.255.255.0), Dynamic Route (RIP2-B), Direction (None), Multicast (Disabled), and IGMP Snoop (Disabled). The 'DHCP' section has radio buttons for Disabled, Enabled, and Relay. The 'DHCP Server' section includes Starting IP Address (192.168.2.2), IP Pool Count (100), and Lease Time (259200 seconds). The 'DNS' section has a dropdown for DNS Relay (Use Auto Discovered DNS Server Only) and fields for Primary and Secondary DNS Servers (both N/A). At the bottom, there are 'SAVE' and 'CANCEL' buttons.

- Router Local IP

Parameter	Description
IP Address	Enter the IP Address of the ADSL router for the local user to access the router’s web page. By default, the IP Address is <b>192.168.2.1</b> .

Parameter	Description
IP Subnet Mask	Enter the Subnet Mask of the ADSL router. By default, the Subnet Mask is <b>255.255.255.0</b> .
Dynamic Route	Dynamic routing allows routing tables in routers to change as the possible routes change. This router supports RIP1, RIP2-B and RIP2-M protocols for dynamic routing. After the RIP protocol is selected, please choose the RIP direction from “None”, “Both”, “IN Only” or “OUT Only”.
Multicast	Specify the method of transmitting data simultaneously to many receivers. Please select “IGMP v1” or “IGMP v2” as the multicast protocol or select “Disabled” to disable the function.
IGMP Snoop	When “IGMP Snoop” (Internet Group Management Protocol Snoop) is enabled, the router can make intelligent multicast forwarding decisions by examining the contents of each frame’s IP header. Without the function, the router will broadcast the multicast packets to each port and may create excessive traffic in the network and degrade the performance of the network.

- **DHCP**

Parameter	Description
DHCP	You can enable or disable the DHCP server. By enabling the DHCP server the router will automatically give your LAN clients an IP address. If the DHCP is not enabled then you’ll have to manually set your LAN client’s IP addresses.
Starting IP Address	If the DHCP Server is enabled, please set the “Starting

IP Address” which will be the first IP Address assigned to the LAN client. By default, the “Starting IP Address” is **192.168.2.100**.

IP Pool Count                      You can select a particular IP address range for your DHCP server to issue IP addresses to your LAN Clients. By default, the “IP Pool Count” is 100. The IP range is starting from IP 192.168.2.100 to 192.168.2.199.

---

Parameter	Description
Lease Time	In the Lease Time setting you can specify the time period that the DHCP Server lends an IP address to your LAN clients. The DHCP will change your LAN client’s IP address when this time threshold period is terminated.
DNS Relay	A Domain Name System (DNS) server is like an index of IP addresses and Web addresses. If you type a Web address into your browser, such as “www.router.com”, a DNS server will find that name in its index and the matching IP address. Please select “Use Auto Discovered DNS Server Only” to auto set the DNS Server. If there is a DNS server that you would rather to use, please select “Use Discovered DNS Server Only” and you need to specify the IP address of that DNS server.
Primary DNS Server	Enter the ISP’s DNS Server IP Address; or you can specify your own preferred DNS Server IP Address.
Secondary DNS Server	This is optional. You can enter another DNS Server’s IP Address as a backup. The secondary DNS will be used should the Primary DNS fail.

---

---



## 5.2.3. Wireless

**EDIMAX**  
NETWORKING PEOPLE TOGETHER

ADSL Router

Interface | Quick Start | **Interface Setup** | Advanced Setup | Access Management | Maintenance | Status | Help

Internet | LAN | **Wireless**

---

**Access Point Settings**

Access Point :  Activated  Deactivated

Channel : Undefined  Current Channel:

Beacon Interval :  (range: 20~1000)

RTS/CTS Threshold :  (range: 1500~2347)

Fragmentation Threshold :  (range: 256~2346, even numbers only)

DTIM :  (range: 1~255)

Wireless Mode :

---

**11n Settings**

Channel Bandwidth :

Guard Interval :

MCS :

---

**Multiple SSIDs Settings**

SSID Index :

Broadcast SSID :  Yes  No

WMM :  Enable  Disable

Use WPS :  Yes  No

---

**WPS Settings**

WPS state : Configured

WPS mode :  PIN code  PBC

- **Access Point Settings**

Parameter	Description
Access Point	Activated or deactivated the wireless function of the router. When it is activated, the router will be an access point for other wireless clients to connect wirelessly.
Channel	It is the radio channel used by the wireless LAN. All devices in the same wireless LAN should use the same channel. Please select the country you are located and designate a channel that the router will use. If you want to let the router automatically find an available channel with the highest signal strength, please select "Auto". The

auto-selective channel will be shown in the “Current Channel” field.

SSID	The SSID (up to 32 printable ASCII characters) is the unique name identified in a WLAN. The ID prevents the unintentional merging of two co-located WLANs. The default SSID of the router is “default”.
Beacon Interval	The interval of time that this wireless router broadcast a beacon. Beacon is used to synchronize the wireless network. The range for the beacon period is between 20 and 1000 with a typical value of 100 (milliseconds).
RTS/CTS Threshold	When the packet size is smaller than the RTS threshold, the wireless router will not use the RTS/CTS mechanism to send this packet. The range is from 1500 to 2347.
Fragmentation Threshold	Fragment Threshold specifies the maximum size of packet during the fragmentation of data to be transmitted. If you set this value too low, it will result in bad performance. Enter a value from 256 to 2346.
DTIM	Determines the interval the Access Point will send its broadcast traffic. The range is from 1 to 255 and the default value is 3 beacons.
802.11b/g/n	<p>802.11 b – This router will only work in 802.11b mode. If there are only 802.11b wireless clients in the network, you can set the router to this mode.</p> <p>802.11 g – This router will only work in 802.11g mode. If there are only 802.11g wireless clients in the network, you can set the router to this mode.</p> <p>802.11 b+g+n – This router will support 802.11b, 802.11g and 802.11n communications simultaneously. It is</p>

---

recommended to set this mode.

Channel Bandwidth 20MHz or 20/40MHz Auto.

---

- **Multiple SSIDs Settings**

Parameter	Description
SSID Index	This router can support multiple SSIDs. By default, this function is disabled. You can only set a set of SSID.
SSID	The SSID (up to 32 printable ASCII characters) is the unique name identified in a WLAN. The ID prevents the unintentional merging of two co-located WLANs. The default SSID of the router is "default".
Broadcast SSID	Select "Yes" to make the SSID to be visible so wireless clients can scan the router within the network. Select "No" if you want to hide the SSID of the router. Wireless clients have to set the same SSID of the router in order to access the network.
Authentication Type	To prevent unauthorized wireless clients from accessing the router, this router supports WEP, WPA-PSK and WPA2-PSK authentication type. If the router has enabled the authentication, all the wireless clients' settings have to be consistent with the router for building the connection.

---

- **WEP/WPA-PSK/WPA2-PSK**

Parameter	Description
WEP-64Bits	WEP is less level of security than WPA. WEP supports 64-bit and 128-bit key lengths to encrypt the wireless data. The longer key length will provide higher security. When “WEP-64Bits” is selected, you have to enter exactly 5 ASCII characters (“a-z” and “0-9”) or 10 hexadecimal digits (“0-9”, “a-f”) for each Key (1-4).
WEP-128Bits	When “WEP-128Bits” is selected, you have to enter exactly 13 ASCII characters (“a-z” and “0-9”) or 26 hexadecimal digits (“0-9”, “a-f”) for each Key (1-4).

---

Parameter	Description
WPA-PSK	WPA-PSK is suitable for home and small business. It uses TKIP or AES for data encryption. When “WPA-PSK” is selected, please select the encryption method and enter 8-63 characters as the “Pre-Shared Key”.
WPA2-PSK	WPA2-PSK is also for home and small business. It uses TKIP or AES for data encryption. WPA2-PSK offers the highest level of security. When “WPA2-PSK” is selected, please select the encryption method and enter 8-63 characters as the “Pre-Shared Key”.

---

- **Wireless MAC Address Filter**

Parameter	Description
Active	This router can prevent the wireless clients from accessing the wireless network by checking the MAC Address of the clients. If you enable this function, please set the MAC Address of the wireless clients that you want to filter.
Action	Allow Association – Only allow the wireless clients with the MAC Address you have specified can access to the router.  Deny Association – The wireless clients with the MAC Address you have specified will be denied accessing to the router.
Mac Address #1-8	Please enter the MAC Address of the wireless clients for the filtering control.

---

## 5.3. Advanced Setup

### 5.3.1. Firewall

**EDIMAX**  
NETWORKING PEOPLE TOGETHER

ADSL Router

Advanced | Quick Start | Interface Setup | **Advanced Setup** | Access Management | Maintenance | Status | Help

Firewall | Routing | NAT | ADSL

Firewall

Firewall :  Enabled  Disabled  
SPI :  Enabled  Disabled  
(WARNING: If You enabled SPI, all traffics initiated from WAN would be blocked, including DMZ, Virtual Server, and ACL WAN side.)

SAVE CANCEL

Parameter	Description
Firewall	When you enable the firewall function, it will protect you from following attacks of WAN side: <ul style="list-style-type: none"><li>• SYN flooding attack</li><li>• Ping of Death</li><li>• Teardrop</li><li>• Land attack</li></ul>
SPI	If you enable SPI, all traffics initiated from WAN site will be blocked including DMZ, Virtual Server, etc.

## 5.3.2. Routing

The screenshot shows the EDIMAX ADSL Router web interface. The top navigation bar includes 'Advanced', 'Quick Start', 'Interface Setup', 'Advanced Setup', 'Access Management', 'Maintenance', 'Status', and 'Help'. The 'Advanced Setup' menu is expanded to show 'Firewall', 'Routing', 'NAT', and 'ADSL'. The 'Routing Table List' section displays a table with the following data:

#	Dest IP	Mask	Gateway IP	Metric	Device	Use	Edit	Drop
1	192.168.2.0	24	192.168.2.1	1	enet0	5587		

Below the table is an 'ADD ROUTE' button.

- **Routing Table List**

You can see the current routing table of the router here. If you want to add another routing rule, please click “ADD ROUTE”.

Parameter	Description
Dest IP	Show the IP Address of the destination LAN.
Mask	Show the Subnet Mask of the destination LAN. If it shows “8” that means the Subnet Mask is “255.0.0.0”; “16” means the Subnet Mask is “255.255.0.0”; “24” means the Subnet Mask is “255.255.255.0”.
Parameter	Description
Gateway IP	The next stop gateway of the path toward the destination LAN. This is the IP of the neighbor router that this router should communicate with on the path to the destination LAN.
Metric	The number of hops (routers) to pass through to reach the destination LAN. It must be between 1 and 15.
Device	Show the interface that go to the next hop (router), such as LAN port.

Use	The counter for access time.
Edit	Edit the route, this icon is not shown for system default route.
Drop	Drop the route, this icon is not shown for system default route.

- **Add Route**

If you have another router with a LAN-to-LAN connection, you may need to create a static routing on the router that is the gateway to Internet.

The screenshot shows the EDIMAX ADSL Router web interface. The top navigation bar includes 'Advanced', 'Quick Start', 'Interface Setup', 'Advanced Setup' (highlighted), 'Access Management', 'Maintenance', 'Status', and 'Help'. Below this, there are sub-menus for 'Firewall', 'Routing', 'NAT', and 'ADSL'. The 'Static Route' configuration page is displayed, featuring the following fields and controls:

- Destination IP Address:
- IP Subnet Mask:
- Gateway IP Address:   PVC0
- Metric:
- Announced in RIP:  Yes

At the bottom of the configuration area, there are four buttons: , , , and .

Parameter	Description
Destination IP Address	Enter the IP Address of the destination LAN.
IP Subnet Mask	Enter the Subnet Mask address of the destination LAN.
Gateway IP Address	This is the gateway IP Address where packets are sent. Enter the gateway IP Address and select the channel (PVC) you want to configure.
Metric	The number of hops (routers) to pass through to reach the destination LAN. It must be between 1 and 15.



Announced in RIP

Select “Yes”, this routing path will be propagated to other hosts through RIP broadcasts. Select “No”, this routing path will be kept private and it is not included in RIP broadcasts.

### 5.3.3. NAT

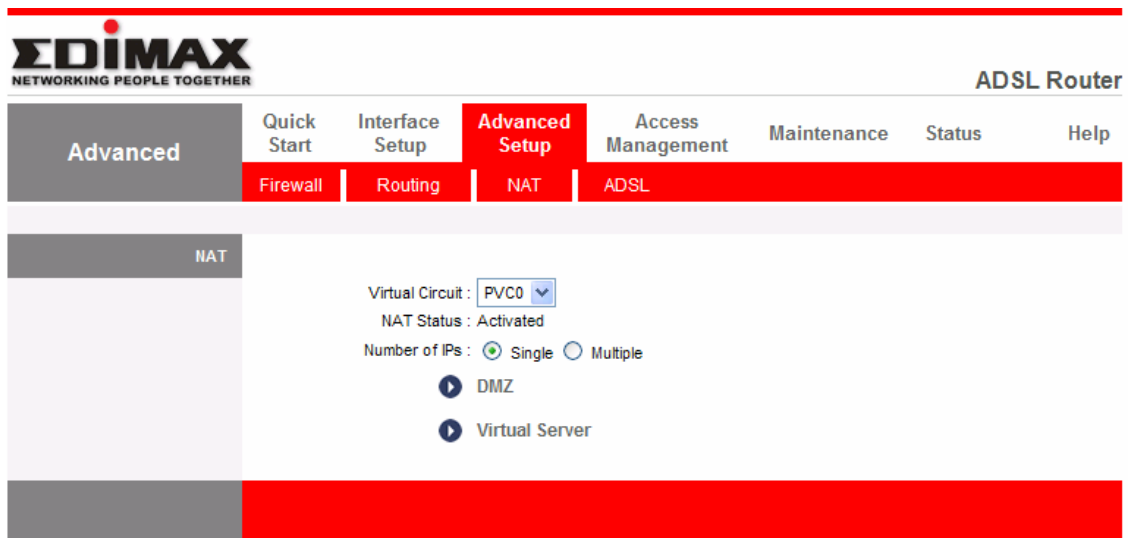

#### 5.3.3.1. NAT

Network Address Translation (NAT) allows multiple users at your local site to access the Internet through a single Public IP Address or multiple Public IP Addresses. NAT provides Firewall protection from hacker attacks and has the flexibility to allow you to map Private IP Addresses to Public IP Addresses for key services such as Websites and FTP.

Parameter	Description
Virtual Circuit	VPI (Virtual Path Identifier) and VCI (Virtual Channel Identifier) define a virtual circuit. Please select the channel (PVC) you want to configure.
NAT Status	The activated or deactivated status for the NAT function will be shown here.

Number of IPs                      Select "Single" if you only have a public IP Address.  
    Select "Multiple" if you have multiple IP Addresses.

---

### 5.3.3.2. DMZ

The DMZ Host is a local computer exposed to the Internet. When setting a particular internal IP Address as the DMZ Host, all incoming packets will be checked by the firewall and NAT algorithms then passed to the DMZ Host.

For example, if you have a local client PC that cannot run an Internet application (e.g. Games) properly from behind the NAT firewall, then you can open the client up to unrestricted two-way Internet access by defining a DMZ Host.

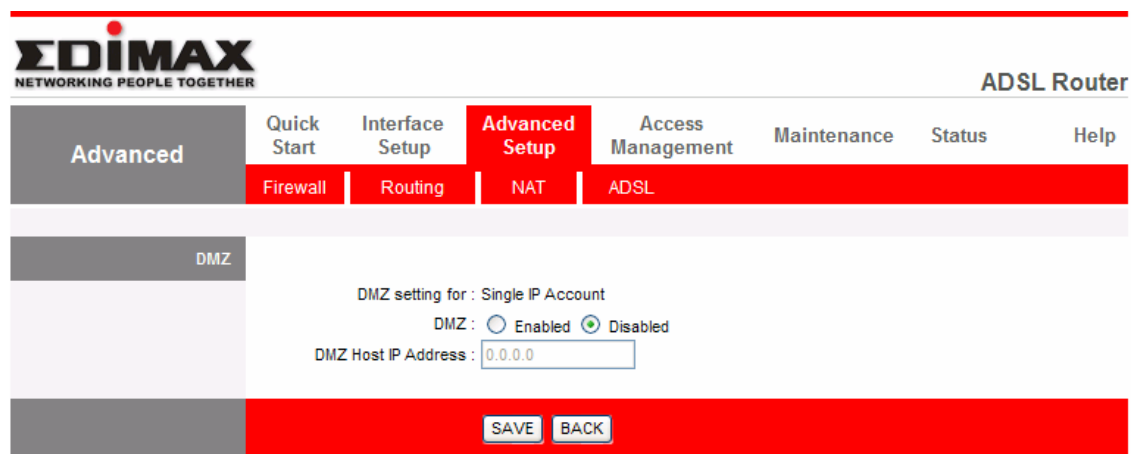

Parameter	Description
DMZ setting for	Show the DMZ setting is for single or multiple IP Addresses.
DMZ	Enable or disable the DMZ function.
DMZ Host IP Address	Enter a static IP Address to the DMZ Host. This IP Address will be exposed to the Internet.

---

### 5.3.3.3. Virtual Server

Use the Virtual Server function when you want different servers/clients in your LAN to handle different service/Internet application type (e.g. Email, FTP, Web

---

server etc.) from the Internet. Computers use numbers called port numbers to recognize a particular service/Internet application type. The Virtual Server allows you to re-direct a particular service port number (from the Internet/WAN) to a particular LAN private IP Address and its service port number.

The screenshot shows the EDIMAX ADSL Router configuration interface. The top navigation bar includes 'Advanced', 'Quick Start', 'Interface Setup', 'Advanced Setup' (highlighted), 'Access Management', 'Maintenance', 'Status', and 'Help'. Below this, a secondary bar shows 'Firewall', 'Routing', 'NAT', and 'ADSL' (highlighted). The main content area is titled 'Virtual Server' and contains the following settings:

- Virtual Server for : Single IP Account
- Rule Index : 1
- Application : -
- Protocol : ALL
- Start Port Number : 0
- End Port Number : 0
- Local IP Address : 0.0.0.0

Below the settings is a 'Virtual Server Listing' table:

Rule	Application	Protocol	Start Port	End Port	Local IP Address
1	-	-	0	0	0.0.0.0
2	-	-	0	0	0.0.0.0
3	-	-	0	0	0.0.0.0
4	-	-	0	0	0.0.0.0
5	-	-	0	0	0.0.0.0
6	-	-	0	0	0.0.0.0
7	-	-	0	0	0.0.0.0
8	-	-	0	0	0.0.0.0
9	-	-	0	0	0.0.0.0
10	-	-	0	0	0.0.0.0
11	-	-	0	0	0.0.0.0
12	-	-	0	0	0.0.0.0

Parameter	Description
Virtual Server for	Show the Virtual Server setting is for single or multiple IP Addresses.
Rule Index	Choose the rule number.
Application	Select the application of the virtual server, for example: FTP or HTTP Server. When the application is selected, the port number for the application will be assigned automatically.

Parameter	Description
Start Port Number	Enter the start port number.
End Port Number	Enter the end port number.
Local IP Address	It is recommended to enter a static IP Address for the server here. If the server's IP Address is obtained from DHCP Server, the IP Address may be changed dynamically and will cause problem on this feature. Please assign a static IP Address to the server and make sure that the IP Address is not in the range of IP Addresses that the DHCP Server will assign.

### 5.3.4. ADSL

The screenshot shows the EDIMAX ADSL Router configuration interface. The top navigation bar includes 'Advanced', 'Quick Start', 'Interface Setup', 'Advanced Setup', 'Access Management', 'Maintenance', 'Status', and 'Help'. The 'Advanced Setup' menu is expanded to show 'Firewall', 'Routing', 'NAT', and 'ADSL'. The 'ADSL' configuration page displays two dropdown menus: 'ADSL Mode' set to 'Auto Sync-Up' and 'ADSL Type' set to 'ANNEX A'. A 'SAVE' button is located at the bottom of the configuration area.

Parameter	Description
ADSL Mode	The default setting is “Auto Sync-Up”. This mode will automatically detect the ADSL mode including ADSL2+, ADSL2, G.DMT, T1.413 and G.lite. If you are not sure how to select the ADSL mode, please contact with your ISP.
ADSL Type	Check with your ISP about the ADSL type of the DSLAM device they use.

## 5.4. Access Management

### 5.4.1. ACL

If you want to restrict users from accessing certain Internet applications/services such as Internet websites, email, FTP etc., then this is the place to set that configuration. Access Control allows users to define the traffic type permitted in your LAN or WAN. You can control which computer can have access to these services by entering the IP Address of the computer.

The screenshot shows the EDIMAX ADSL Router web interface. The top navigation bar includes 'Quick Start', 'Interface Setup', 'Advanced Setup', 'Access Management' (highlighted in red), 'Maintenance', 'Status', and 'Help'. Below this, a secondary navigation bar shows 'ACL', 'Filter', 'SNMP', 'UPnP', and 'DDNS'. The main content area is titled 'Access Control Setup' and includes a section for 'Access Control Editing'. In this section, there are radio buttons for 'ACL' (Activated/Deactivated), a dropdown for 'ACL Rule Index' (set to 1), radio buttons for 'Active' (Yes/No), a text input for 'Secure IP Address' (0.0.0.0 ~ 0.0.0.0), a dropdown for 'Application' (Web), and a dropdown for 'Interface' (Both). Below the editing section is a table with columns: Index, Active, Secure IP Address, Application, and Interface. At the bottom, there are 'SAVE', 'DELETE', and 'CANCEL' buttons.

Parameter	Description
ACL	Activate or deactivate the Access Control function. When you have activated the function, please do make sure that you have designated the available applications/services or you will be denied to access all the services.
ACL Rule Index	This is the item number to record the setting rule.
Secure IP Address	The default 0.0.0.0~0.0.0.0 allows any user to use this service to remotely manage the router. Type a range of IP Addresses to authorize access to a number of users with matching IP Addresses.

Application Choose the services that you permit to use in your LAN or WAN interface. These services include Web, FTP, Telnet, SNMP and Ping.

Interface Select the interface that the user is allowed to use services through it. It includes LAN, WAN or Both.

---

## 5.4.2. IP Filter

You can forbid some users accessing to the router by filtering the users through IP Address or MAC Address. You can also restrict some applications or URLs be accessing by users through the router here. Please select the filter type to start configuring.

The screenshot shows the EDIMAX ADSL Router configuration interface. The top navigation bar includes 'Access Management', 'Quick Start', 'Interface Setup', 'Advanced Setup', 'Access Management' (highlighted), 'Maintenance', 'Status', and 'Help'. Below this, a sub-menu shows 'ACL', 'Filter' (highlighted), 'SNMP', 'UPnP', and 'DDNS'. The main content area is titled 'Filter' and contains the following sections:

- Filter Type**: Filter Type Selection: IP / MAC Filter
- IP / MAC Filter Set Editing**: IP / MAC Filter Set Index: 1, Interface: PVC0, Direction: Both
- IP / MAC Filter Rule Editing**: IP / MAC Filter Rule Index: 1, Rule Type: IP, Active:  Yes  No

Source IP Address:  (0.0.0.0 means Don't care)  
Subnet Mask:   
Port Number: 0 (0 means Don't care)

Destination IP Address:  (0.0.0.0 means Don't care)  
Subnet Mask:   
Port Number: 0 (0 means Don't care)

---

### 5.4.2.1. IP/MAC Filter

**EDIMAX**  
NETWORKING PEOPLE TOGETHER

ADSL Router

**Access Management** | Quick Start | Interface Setup | Advanced Setup | **Access Management** | Maintenance | Status | Help

ACL | Filter | SNMP | UPnP | DDNS

**Filter**

**Filter Type**

Filter Type Selection : IP / MAC Filter

**IP / MAC Filter Set Editing**

IP / MAC Filter Set Index : 1  
Interface : PVC0  
Direction : Both

**IP / MAC Filter Rule Editing**

IP / MAC Filter Rule Index : 1  
Rule Type : IP  
Active :  Yes  No

Source IP Address : (0.0.0.0 means Don't care)  
Subnet Mask :  
Port Number : 0 (0 means Don't care)

Destination IP Address : (0.0.0.0 means Don't care)  
Subnet Mask :  
Port Number : 0 (0 means Don't care)

- **IP / MAC Filter Set Editing**

Parameter	Description
IP/MAC Filter Set Index	This is the item number to record the setting.
Interface	Select which channel (PVC) to configure.
Direction	Select the access to the Internet (Outgoing) or from the Internet (Incoming), or Both.

- **IP / MAC Filter Rule Editing**

Parameter	Description
IP/MAC Filter Rule Index	This is the item number to record the setting rule.
Rule Type	Select to filter through the IP Address or MAC Address.
Active	Select "Yes" to enable the current rule, select "No" to cancel the current rule.
Source IP Address	Enter the start IP Address which will be monitored. If "0.0.0.0" is set, it means for any IP Address.
Subnet Mask	Enter the Subnet Mask based on the Source IP Address.
Port Number	LAN users use port number to distinguish one network application over another such as 21 is for FTP service. The port number range is from 0 to 65535. It is recommended that this option be configured by an advanced user.
Destination IP Address	Enter the start IP Address which will be monitored. If "0.0.0.0" is set, it means for any IP Address.
Subnet Mask	Enter the Subnet Mask based on the Destination IP Address.
Port Number	This is the port or port ranges that define the application.
Protocol	It is the packet protocol type used by the application. Please select "TCP", "UDP" or "ICMP". For example, FTP service, you have to select "TCP".
MAC Address	The MAC address (Media Access Control address) is a



hardware address that uniquely identifies each node of a network. If the rule type is “MAC”, you have to designate the MAC address that you want to filter.

Rule Unmatched      Select action for the traffic unmatching current rule.  
 “Forward” is to leave it pass through; “Next” is to check it by the next rule.

• **IP / MAC Filter Listing**

The IP/MAC Filter Listing will list the IP/MAC Filter rules you have configured. You can review the settings here.

IP / MAC Filter Listing

IP / MAC Filter Set Index: 1    Interface: -    Direction: -

#	Active	Src Address/Mask	Dest IP/Mask	Src Port	Dest Port	Protocol	Unmatched
1	-	-	-	-	-	-	-
2	-	-	-	-	-	-	-
3	-	-	-	-	-	-	-
4	-	-	-	-	-	-	-
5	-	-	-	-	-	-	-
6	-	-	-	-	-	-	-

SAVE    DELETE    CANCEL

5.4.2.2. Application Filter



ADSL Router

Access Management    Quick Start    Interface Setup    Advanced Setup    **Access Management**    Maintenance    Status    Help

ACL    Filter    SNMP    UPnP    DDNS

Filter

Filter Type

Filter Type Selection: Application Filter

Application Filter Editing

Application Filter :  Activated  Deactivated

ICQ :  Allow  Deny

MSN :  Allow  Deny

YMSG :  Allow  Deny

Real Audio/Video :  Allow  Deny

SAVE    CANCEL

Parameter	Description
Application Filter	Activate or deactivate the application filter.
ICQ/MSN/YMSG/Real Audio/Video	If “Allow” is selected, the packets for these applications will be able to pass through the router. If you want to restrict these applications, please select “Deny”.

### 5.4.2.3. URL Filter

The screenshot shows the EDIMAX ADSL Router web interface. The navigation menu includes 'Access Management', 'Quick Start', 'Interface Setup', 'Advanced Setup', 'Access Management', 'Maintenance', 'Status', and 'Help'. Under 'Access Management', there are sub-menus for 'ACL', 'Filter', 'SNMP', 'UPnP', and 'DDNS'. The 'Filter' sub-menu is selected, and the 'URL Filter' configuration page is displayed. The page includes a 'Filter Type' dropdown set to 'URL Filter', an 'Active' status set to 'No', and a 'URL Index' dropdown set to '1'. A 'URL' input field is also present. Below these settings is a table for 'URL Filter Listing' with columns for 'Index' and 'URL'.

Index	URL
1	
2	
3	
4	
5	
6	
7	
8	
9	
10	
11	

- URL Filter Editing

Parameter	Description
Active	Activate or deactivate the URL filter.
URL Index	This is the item number to record the setting.

URL A URL can be thought of as the "address" of a web page and is sometimes referred to informally as a "web address." Please enter the web address here that you want to restrict to be connected.

---

- **URL Filter Listing**

The URL Filter Listing will list the URL you have configured. You can review the settings here.

### 5.4.3. SNMP

Simple Network Management Protocol (SNMP) is a popular protocol for network management. It is used for collecting information and configuring the network devices. This router supports SNMP agent function, which allows a manager station to manage and monitor the router through the network.

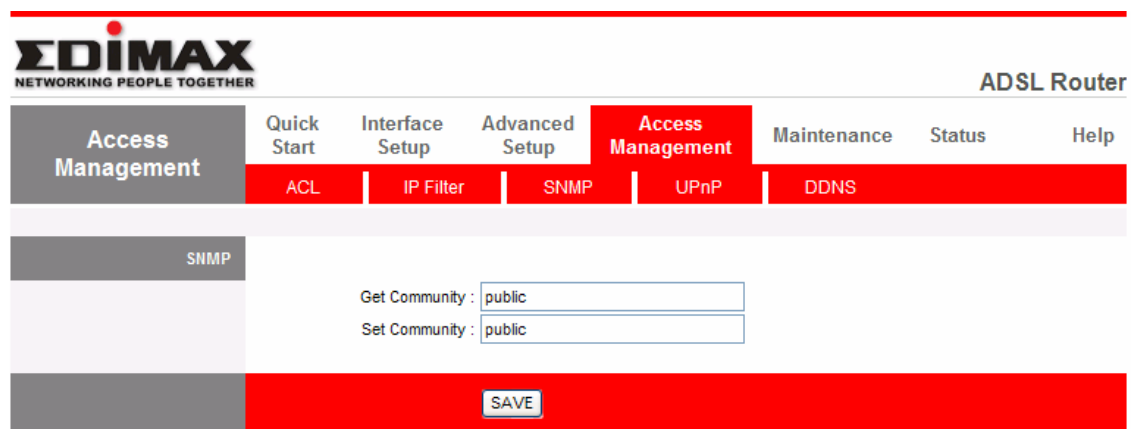

Parameter	Description
Get Community	Enter the password for the incoming Get- and GetNext requests from the management station.
Set Community	Enter the password for a Set request to configure the router.

---

## 5.4.4. UPnP

When the UPnP function is enabled, the router can be detected by UPnP compliant system such as Windows XP. The router will be displayed in the Neighborhood of Windows XP, so you can directly double click the router or right click the router and select “Invoke” to configure the router through web browser.

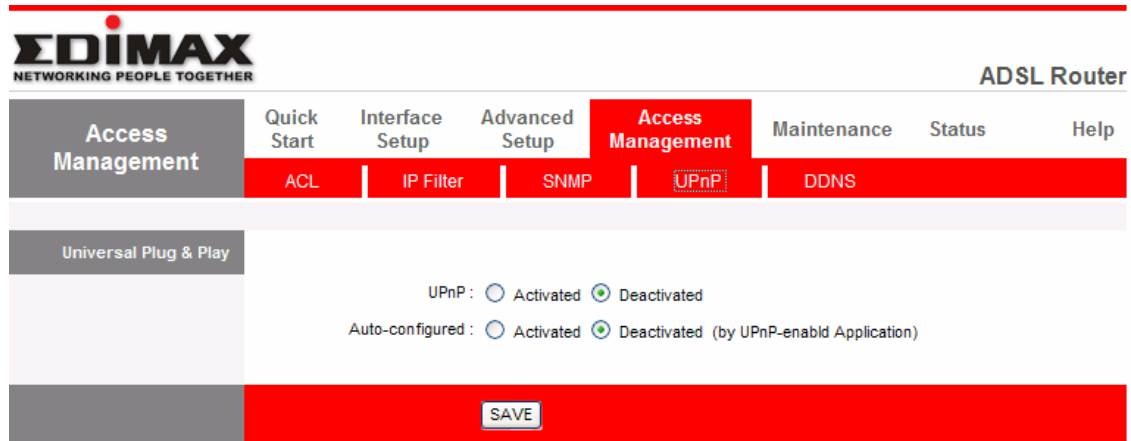

Parameter	Description
UPnP	Activated or deactivated the UPnP function.
Auto-configured	Select this check box to allow UPnP-enabled applications to automatically configure the router so that they can communicate through the router, for example by using NAT traversal, UPnP applications automatically reserve a NAT forwarding port in order to communicate with another UPnP enabled device; this eliminates the need to manually configure port forwarding for the UPnP enabled application.

## 5.4.5. DDNS

DDNS allows you to map the static domain name to a dynamic IP address. You must get an account, password and your static domain name from the DDNS service providers.

**EDIMAX**  
NETWORKING PEOPLE TOGETHER

ADSL Router

Access Management | Quick Start | Interface Setup | Advanced Setup | **Access Management** | Maintenance | Status | Help

ACL | IP Filter | SNMP | UPnP | **DDNS**

Dynamic DNS

Dynamic DNS :  Activated  Deactivated

Service Provider : www.dyndns.org

My Host Name :

E-mail Address :

Username :

Password :

Wildcard support :  Yes  No

**SAVE**

Parameter	Description
Dynamic DNS	Activated or deactivated the DDNS function.
Service Provider	This router supports DynDNS service provider.
My Host Name	Enter the domain name assigned to your router by the service provider.
E-mail Address	Enter the E-mail address assigned by DDNS service provider.
Username	Enter your username.
Password	Enter the password you set for the DDNS service.
Wildcard Support	Enable or disable the wildcard to stand for some characters.

## 5.5. Maintenance

### 5.5.1. Administrator

---

The screenshot shows the EDIMAX ADSL Router web interface. At the top left is the EDIMAX logo with the tagline "NETWORKING PEOPLE TOGETHER". At the top right is the text "ADSL Router". Below the logo is a navigation menu with the following items: Maintenance (highlighted), Quick Start, Interface Setup, Advanced Setup, Access Management, Status, and Help. Under the Maintenance menu, there are sub-items: Administration, Time Zone, Firmware, SysRestart, and Diagnostics. The main content area is titled "Administrator" and contains the following fields: Username: admin, New Password: [text input], and Confirm Password: [text input]. At the bottom of the form are two buttons: SAVE and CANCEL.

Parameter	Description
Username	The username of the router is "admin" by default.
New Password	Enter up to 30-digit of the new password.
Confirm Password	Enter the new password again to confirm the setting.

## 5.5.2. Time Zone

The Time Zone allows your router to set its time; this will affect function such as System Log.

The screenshot shows the EDIMAX ADSL Router web interface. The top navigation bar includes 'Maintenance', 'Quick Start', 'Interface Setup', 'Advanced Setup', 'Access Management', 'Maintenance' (highlighted), 'Status', and 'Help'. Below this, a secondary navigation bar has 'Administration', 'Time Zone' (highlighted), 'Firmware', 'SysRestart', and 'Diagnostics'. The main content area is titled 'Time Zone' and shows 'Current Date/Time : 01/01/2000 00:09:12'. Under 'Time Synchronization', there are three radio buttons: 'NTP Server automatically' (selected), 'PC's Clock', and 'Manually'. Below these is a 'Time Zone' dropdown menu showing '(GMT) Greenwich Mean Time : Dublin, Edinburgh, Lisbon, London'. There are also 'Daylight Saving' radio buttons for 'Enabled' and 'Disabled' (selected). At the bottom, the 'NTP Server Address' is set to '192.43.244.18' with '(0.0.0.0: Default Value)' in parentheses. 'SAVE' and 'CANCEL' buttons are at the bottom right.

Parameter	Description
Current Date/Time	Show the current date/time of the router.
Synchronize time with	NTP Server Automatically – Set the time by following with a NTP Server.  PC's Clock – Set the time the same as your computer.  Manually – Set the time manually.
Time Zone	Select the time zone of the country you are currently in. The router will set its time based on your selection.
Daylight Saving	Select this option if it is in daylight savings time.
NTP Server Address	Enter the IP Address of your time server.

### 5.5.3. Firmware

If you have new firmware for some features update, please upgrade firmware of the router here.

Parameter	Description
Current Firmware Version	The current firmware version will be shown here.
New Firmware Location	Type in the location of the new firmware or click “Browse” to find it.
New Romfile Location	To restore the backup settings, please type in the location of the backup file or click “Browse” to find it.
Romfile Backup	To save the current settings as a backup file, please click “ROMFILE SAVE”. Then please change the file name and select the location you want to save the file.
Upgrade	Click “Upgrade” to begin the upgrade processes or backup file restoring processes. After the router is restarted, the processes are completed. It might take several minutes, don't power off the router during upgrading or restoring.



## 5.5.4. System Restart

In this page, you can restart your router or restore to factory defaults. If you wish to restart the router using the factory default settings, select “Factory Default Settings” to reset to factory defaults. You can also click the “Reset” button in the rear panel of the router over 5 seconds to reset default settings.

The screenshot shows the EDIMAX ADSL Router web interface. The top navigation bar includes 'Maintenance' (highlighted), 'Quick Start', 'Interface Setup', 'Advanced Setup', 'Access Management', 'Status', and 'Help'. Below this, a secondary navigation bar lists 'Administration', 'Time Zone', 'Firmware', 'SysRestart', and 'Diagnostics'. The main content area is titled 'System Restart' and features two radio buttons: 'Current Settings' (selected) and 'Factory Default Settings'. A prominent red 'RESTART' button is located at the bottom of the page.

## 5.5.5. Diagnostics

This page allows you to diagnose the connectivity of the LAN and WAN network.

The screenshot shows the EDIMAX ADSL Router web interface. The top navigation bar includes 'Maintenance' (highlighted), 'Quick Start', 'Interface Setup', 'Advanced Setup', 'Access Management', 'Status', and 'Help'. Below this, a secondary navigation bar lists 'Administration', 'Time Zone', 'Firmware', 'SysRestart', and 'Diagnostics'. The main content area is titled 'Diagnosis Test' and features a dropdown menu for 'Virtual Circuit' set to 'PVC0'. Below the dropdown, a list of diagnostic tests is shown with their results:

Test	Result
>> Testing Ethernet LAN connection ...	PASS
>> Testing ADSL Synchronization .	PASS
>> Testing ATM OAM segment ping ...	PASS
>> Testing ATM OAM end to end ping ...	PASS
>> Ping Primary Domain Name Server .	SKIPPED
>> Ping www.yahoo.com ...	FAIL

## 5.6. Status

### 5.6.1. Device Info

In this page, you can know the device information including firmware, MAC Address, LAN and WAN settings and also the ADSL line status.

---

ADSL Router

Status	Quick Start	Interface Setup	Advanced Setup	Access Management	Maintenance	Status	Help
	Device Info			System Log		Statistics	
Device Information	Firmware Version : 2.11.32.0(NRE0.C29)3.9.9.5 MAC Address : 00:aa:bb:01:23:45						
LAN	IP Address : 192.168.2.1 Subnet Mask : 255.255.255.0 DHCP Server : Enabled						
WAN	Virtual Circuit : <input type="text" value="PVC0"/> Status : Not Connected Connection Type : Dynamic IP IP Address : 0.0.0.0 Subnet Mask : 0.0.0.0 Default Gateway : 0.0.0.0 DNS Server : 0.0.0.0 NAT : Enabled						
ADSL	ADSL Firmware Version : FwVer:3.9.9.5_TC3085 HwVer:T14.F7_3.0 Line State : Down Modulation : N/A Annex Mode : N/A						
	Downstream		Upstream				

---

## 5.6.2. System Log

Display system logs accumulated up to the present time. You can also save the logs for future reviewing.

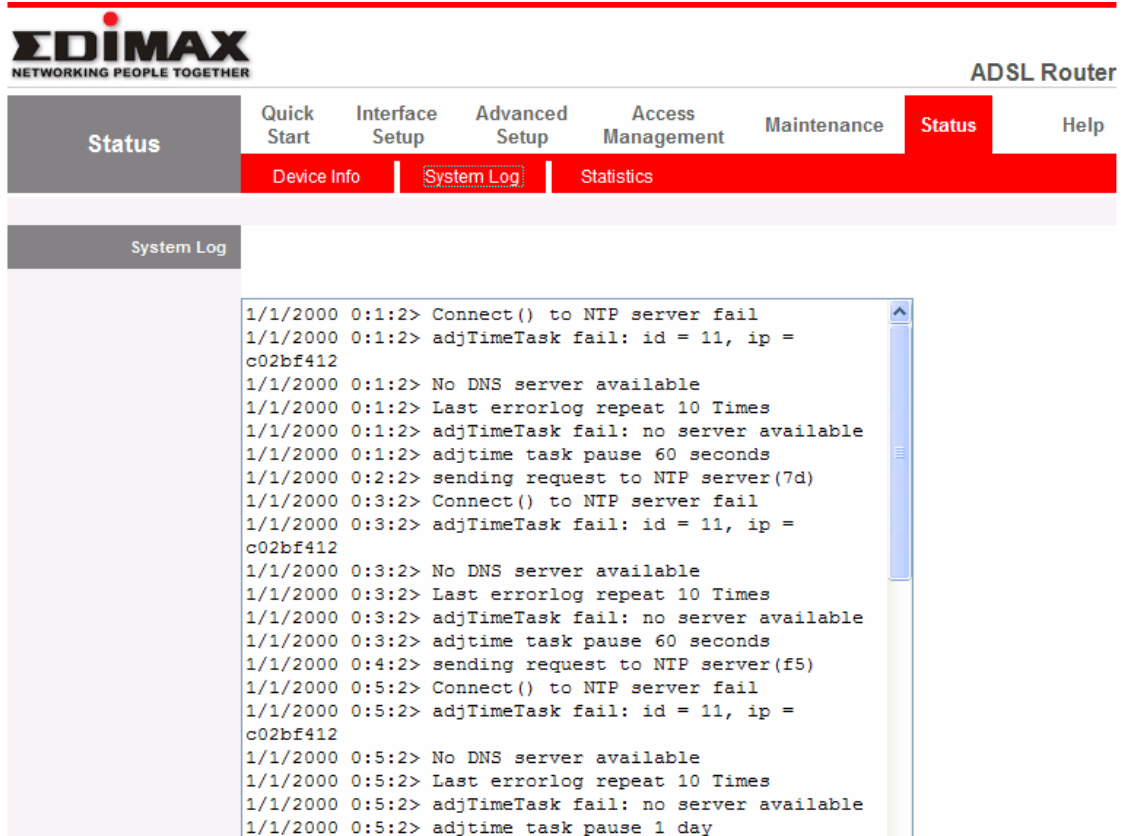

The screenshot shows the EDIMAX ADSL Router web interface. At the top left is the EDIMAX logo with the tagline "NETWORKING PEOPLE TOGETHER". At the top right, it says "ADSL Router". Below the logo is a navigation menu with tabs: "Status", "Quick Start", "Interface Setup", "Advanced Setup", "Access Management", "Maintenance", "Status", and "Help". The "Status" tab is selected, and within it, the "System Log" sub-tab is active. The main content area displays a scrollable list of system log entries. The log entries are as follows:

```
1/1/2000 0:1:2> Connect() to NTP server fail
1/1/2000 0:1:2> adjTimeTask fail: id = 11, ip =
c02bf412
1/1/2000 0:1:2> No DNS server available
1/1/2000 0:1:2> Last errorlog repeat 10 Times
1/1/2000 0:1:2> adjTimeTask fail: no server available
1/1/2000 0:1:2> adjtime task pause 60 seconds
1/1/2000 0:2:2> sending request to NTP server(7d)
1/1/2000 0:3:2> Connect() to NTP server fail
1/1/2000 0:3:2> adjTimeTask fail: id = 11, ip =
c02bf412
1/1/2000 0:3:2> No DNS server available
1/1/2000 0:3:2> Last errorlog repeat 10 Times
1/1/2000 0:3:2> adjTimeTask fail: no server available
1/1/2000 0:3:2> adjtime task pause 60 seconds
1/1/2000 0:4:2> sending request to NTP server(f5)
1/1/2000 0:5:2> Connect() to NTP server fail
1/1/2000 0:5:2> adjTimeTask fail: id = 11, ip =
c02bf412
1/1/2000 0:5:2> No DNS server available
1/1/2000 0:5:2> Last errorlog repeat 10 Times
1/1/2000 0:5:2> adjTimeTask fail: no server available
1/1/2000 0:5:2> adjtime task pause 1 day
```

### 5.6.3. Statistics

Show the statistics of transmit and receive packets on the LAN port, ADSL line or WLAN port.

---

ADSL Router

[Quick Start](#) | [Interface Setup](#) | [Advanced Setup](#) | [Access Management](#) | [Maintenance](#) | **[Status](#)** | [Help](#)

[Device Info](#) | [System Log](#) | **[Statistics](#)**

---

**Traffic Statistics**

Interface :  Ethernet  ADSL  WLAN

Transmit Statistics		Receive Statistics	
Transmit Frames	876	Receive Frames	1835
Transmit Multicast Frames	583	Receive Multicast Frames	838
Transmit total Bytes	1118347	Receive total Bytes	796654
Transmit Collision	0	Receive CRC Errors	0
Transmit Error Frames	0	Receive Under-size Frames	0

[REFRESH](#)

---

## 6. Troubleshooting

1. The LAN LED on the front panel does not light up.

STEPS	CORRECTIVE ACTION
1	Check the Ethernet cable connections between your ADSL2+ Router and the computer or hub.
2	Check for faulty Ethernet cables.
3	Make sure your computer's Ethernet card is working properly.
4	If these steps fail to correct the problem, contact your local distributor for assistance.

2. The ADSL LED on the front panel does not light up.

STEPS	CORRECTIVE ACTION
1	Check the telephone wire and connections between ADSL2+ Router DSL port and the wall jack.
2	Make sure that the telephone company has checked your phone line and set it up for DSL service.
3	Reset your ADSL line to reinitialize your link to the DSLAM.
4	If these steps fail to correct the problem, contact your local distributor for assistance.

3. I cannot access the web management.

STEPS	CORRECTIVE ACTION
1	Make sure you are using the correct IP address of ADSL2+ Router. Check the IP address of ADSL2+ Router.
2	Your computer and ADSL2+ Router's IP addresses must be on the same subnet for LAN access.
3	If you have changed ADSL2+ Router's LAN IP address, then enter the new one as the URL.

The following procedures will help you to check the current IP Address setting of your computer. You can compare if your computer and router's IP Addresses are in the same subnet.

Step 1: Click "Start" and select "Run".

Step 2: Type in "cmd" and click "OK".

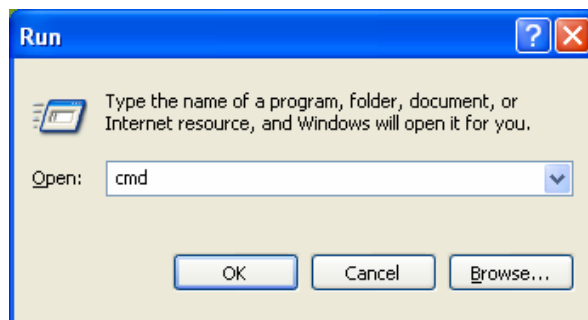

Step 3: Type ipconfig /all and click enter.

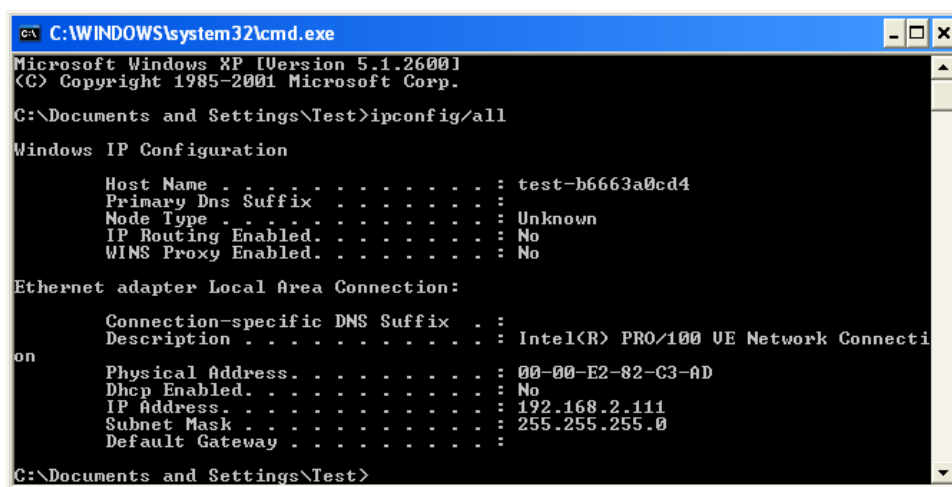

- Your PC's IP address is 192.168.2.111.
- The PC's Subnet Mask is 255.255.255.0.
- Your PC's MAC Address is the one entitled Physical Address (00-00-E2-82-C3-AD).

4. I forget my login username and/or password.

<b>STEPS</b>	<b>CORRECTIVE ACTION</b>
1	If you have changed the password and have now forgotten it, you will need to upload the default configuration file. This will erase all custom configurations and restore all of the factory defaults including the password.
2	Press the Reset button for five seconds, and then release it. When the LAN LED begins to blink, the defaults have been restored.
3	The default username is “admin”. The default password is “1234”. The Password and Username fields are case-sensitive. Make sure that you enter the correct password and username using the proper casing.
4	It is highly recommended to change the default username and password. Make sure you store the username and password in a save place.

5. I cannot access the Web Management of the router after activating the ACL function.

<b>STEPS</b>	<b>CORRECTIVE ACTION</b>
1	When ACL is activated, you have to set the ACL rule for allowing some users to use some services. Check if you have set the rules. If not, all the users are forbidden using any of service from LAN or WAN.
2	If you cannot access the Web Management of the router, please press the Reset button over 5 seconds to restore to defaults.
3	After the router is restarting, log in the router with the default IP Address 192.168.2.1.

6. Initialization of the ADSL connection failed.

<b>STEPS</b>	<b>CORRECTIVE ACTION</b>
1	Check the cable connections between the ADSL port and the wall jack. The ADSL LED on the rear panel of the router should be on.
2	Check VPI, VCI, type of encapsulation and type of multiplexing settings are the same as what you collected from your ISP.
3	Restart the router. If you still have problems, you may need to verify your VPI, VCI, type of encapsulation and type of multiplexing settings with the ISP.

7. I cannot get a WAN IP address from the ISP.

<b>STEPS</b>	<b>CORRECTIVE ACTION</b>
1	The ISP provides the WAN IP address after authenticating you. Authentication may be through the user name and password, the MAC address or the host name.
2	The username and password apply to PPPoE and PPPoA encapsulation only. Make sure that you have entered the correct Service Type, User Name and Password (be sure to use the correct casing).

8. Internet connection disconnects.

<b>STEPS</b>	<b>CORRECTIVE ACTION</b>
1	Check the schedule rules.
2	If you use PPPoA or PPPoE encapsulation, check the idle time-out setting.
3	Contact your ISP.



## 7. Glossary

### **10Base-T**

It is an Ethernet standard for Local Area Network (LAN). 10Base-T uses a twisted pair cable with maximum length of 100 meters.

### **AAL**

ATM Adaptation Layer that defines the rules governing segmentation and reassembly of data into cells. Different AAL types are suited to different traffic classes.

### **ADSL**

Asymmetric Digital Subscriber Line, as its name showing, is an asymmetrical data transmission technology with high traffic rate downstream and low traffic rate upstream. ADSL technology satisfies the bandwidth requirement of applications, which demand “asymmetric” traffic, such as web surfing, file download and Video-on-demand (VOD).

### **ATM**

Asynchronous Transfer Mode is a layer 2 protocol supporting high-speed asynchronous data with advanced traffic management and quality of service features.

### **bps**

Bits per second, a standard measurement of digital transmission speeds.

### **Bridge**

A device that connects two or more physical networks and forwards packets between them. Bridges can usually be made to filter packets, that is, to forward only certain traffic. Related devices are: repeaters which simply forward electrical signals from one cable to the other and full-fledged routers which make routing decisions based on several criteria.

**CPE**

Customer Premises Equipment, such as ADSL router, USB modem.

**Default Gateway (Router)**

Every non-router IP device needs to configure a default gateway's IP address. When the device sends out an IP packet, if the destination is not on the same network, the device has to send the packet to its default gateway, which will then send it out towards the destination.

**DHCP**

Dynamic Host Configuration Protocol, this protocol automatically gives every computer on your home network an IP address.

**DNS Server IP Address**

DNS stands for Domain Name System, which allows Internet servers to have a domain name (such as `www.Broadbandrouter.com`) and one or more IP addresses (such as `192.34.45.8`). A DNS server keeps a database of Internet servers and their respective domain names and IP addresses, so that when a domain name is requested (as in typing "`Broadbandrouter.com`" into your Internet browser), the user is sent to the proper IP address. The DNS server IP address used by the computers on your home network is the location of the DNS server your ISP has assigned to you.

**DSL**

Digital Line Subscriber (DSL) technology provides high-speed access over twisted copper pair for connection to the Internet, LAN interfaces, and to broadband services such as video-on-demand, distance learning, and video conferencing.

**Ethernet**

It is a standard for computer networks. Ethernet networks are connected by special cables and hubs or switches, and move data around at up to 10/100 million bits per second (Mbps).

**FTP**

File Transfer Protocol. The Internet protocol (and program) used to transfer files between hosts.

**Idle Timeout**

Idle Timeout is designed so that after there is no traffic to the Internet for a pre-configured amount of time, the connection will automatically be disconnected.

**ISP**

Internet Service Provider is a business that provides connectivity to the Internet for individuals and other businesses or organizations.

**ISP Gateway Address**

The ISP Gateway Address is an IP address for the Internet router located at the ISP's office.

**LAN**

Local Area Network is a group of computers and devices connected together in a relatively small area (such as a house or an office). Your home network is considered a LAN.

**MAC Address**

MAC stands for Media Access Control. A MAC address is the hardware address of a device connected to a network. The MAC address is a unique identifier for a device with an Ethernet interface. It is comprised of two parts: 3 bytes of data that corresponds to the Manufacturer ID (unique for each manufacturer), plus 3 bytes that are often used as the product's serial number.

**MTU**

Maximum Transmission Unit

## **NAT**

Network Address Translator is defined by RFC 1631. Enable a LAN network to use one set of IP address for internal traffic. A NAT box located where the LAN meets the Internet provides the necessary IP address translation. This helps provide a sort of firewall and allow for a wider address range to be used internally without danger of conflict. Using the router's NAT capability, you can access the Internet from any computer on your home network without having to purchase more IP addresses from your ISP.

## **Port**

Network Clients (LAN PC) uses port numbers to distinguish one network application/protocol over another. Below is a list of common applications and protocol/port numbers:

Application	Protocol	Port Number
Telnet	TCP	23
FTP	TCP	21
SMTP	TCP	25
POP3	TCP	110
H.323	TCP	1720
SNMP	UCP	161
SNMP Trap	UDP	162
HTTP	TCP	80
PPTP	TCP	1723
PC Anywhere	TCP	5631
PC Anywhere	UDP	5632

## **PPP**

PPP is the Point-to-Point-Protocol. The successor to SLIP, PPP provides router-to-router and host-to-network connections over both synchronous and asynchronous circuits.

**PPPoA (RFC 2364)**

The Point-to-Point Protocol (PPP) provides a standard method for transporting multi-protocol data grams over point-to-point links. This document describes the use of ATM Adaptation Layer 5 (AAL5) for framing PPP encapsulated packets.

**PPPoE (RFC 2516)**

This document describes how to build PPP sessions and encapsulate PPP packets over Ethernet. PPP over Ethernet (PPPoE) provides the ability to connect a network of hosts over a simple bridging access device to a remote Access Concentrator.

**Protocol**

A protocol is a set of rules for interaction agreed upon between multiple parties so that when they interface with each other based on such a protocol, the interpretation of their behavior is well defined and can be made objectively, without confusion or misunderstanding.

**PVC**

Permanent Virtual Circuit, connection-oriented permanent leased line circuit between end-stations on a network over a separate ATM circuit.

**RFC**

Request for Comments. The document series, begun in 1969, which describes the Internet suite of protocols and related experiments. Not all RFCs describe Internet standards, but all Internet standards are written up as RFCs.

**RFC 1483**

Multi-protocol encapsulation over AAL-5. Two encapsulation methods for carrying network interconnect traffic over ATM AAL-5. The first method allows multiplexing of multiple protocols over a single ATM virtual circuit. The protocol of a carried PDU is identified by prefixing the PDU by an IEEE 802.2 Logical Link Control (LLC) header. This method is in the following called "LLC Encapsulation". The second method does higher-layer protocol multiplexing implicitly by ATM Virtual Circuits (VCs). It is in the following called "VC Based Multiplexing".

**Router**

A system responsible for making decisions about which of several paths network (or Internet) traffic will follow. To do this, it uses a routing protocol to gain information about the network and algorithms to choose the best route based on several criteria known as "routing metrics."

**Subnet Mask**

A subnet mask, which may be a part of the TCP/IP information provided by your ISP, is a set of four numbers (e.g. 255.255.255.0) configured like an IP address. It is used to create IP address numbers used only within a particular network (as opposed to valid IP address numbers recognized by the Internet, which must be assigned by InterNIC).

**TCP/IP, UDP**

Transmission Control Protocol/Internet Protocol (TCP/IP) and Unreliable Datagram Protocol (UDP). TCP/IP is the standard protocol for data transmission over the Internet. Both TCP and UDP are transport layer protocol. TCP performs proper error detection and error recovery, and thus is reliable. UDP on the other hand is not reliable. They both run on top of the IP (Internet Protocol), a network layer protocol.

**TELNET**

It is the virtual terminal protocol in the Internet suite of protocols. Allows users of one host to log into a remote host and act as normal terminal users of that host.

**VCI**

Virtual Circuit Identifier is part of the ATM cell header. A VCI is a tag indicating the channel over which a cell will travel. The VCI of a cell can be changed as it moves between switches via Signaling.

**VPI**

Virtual Path Identifier is part of the ATM cell header. A VPI is a pipe for a number of Virtual Circuits.

**WAN**

Wide Area Network is a network that connects computers located in geographically separate areas (e.g. different buildings, cities, countries). The Internet is a wide area network.

**Web-based management Graphical User Interface (GUI)**

Many devices support a graphical user interface that is based on the web browser. This means the user can use the familiar Netscape or Microsoft Internet Explorer to Control/configure or monitor the device being managed.

#### **Headquarters**

Edimax Technology co., Ltd  
NO. 3, Wu-Chuan 3rd RD  
Wu-Ku-Industrial Park  
Taipei Hsien, Taiwan. R.O.C.  
TEL : +886-2-77396888  
FAX : +886-2-77396887  
e-mail : sales@edimax.com.tw

#### **European Headquarters**

Edimax Technology Europe B.V.  
Nijverheidsweg 25 5683 CJ Best  
The Netherlands  
TEL : +31-499-377344  
FAX : +31-499-372647  
e-mail : sales@edimax.nl

#### **USA Office**

Edimax Computer Company  
3350 Scott Blvd., Bldg.15  
Santa Clara, CA 95054, USA  
TEL : +1-408-4961105  
FAX : +1-408-9801530  
e-mail : sales@edimax.com

#### **Poland Office**

Edimax Technology Poland. Sp. Z o.o.  
ul. Postepu 14, 02-676 Warsaw, Poland  
TEL : +48-22-6079480  
FAX : +48-22-6079481  
e-mail : sales@edimax.pl

#### **United Kingdom Office**

Edimax Technology (UK) Ltd.  
Suite 378 Silbury Court, Silbury Boulevard  
Milton Keynes MK9 2AF  
TEL : +44-845-1238307  
FAX : +44-845-1238306  
e-mail : info@edimax.co.uk

#### **Latin America Office**

Edimax Latin America Inc.  
2954 NW 72 Ave. Miami, FL 33122. USA.  
TEL : +1-786-8458099  
FAX : +1-786-3318490  
e-mail : sales\_latinamerica@edimax.com

#### **Romania Office**

Edimax Technology Romania  
Bucuresti, str. Splaiul Unirii, nr. 10,  
bl. B5, sc. 1, et. 5, ap.15, sector 4.  
TEL : +40-31-4250126  
FAX : +40-31-4250125  
e-mail : sales@edimax.ro

#### **Germany Office**

Edimax Technology Europe BV  
Hans-Boeckler-Str. 13,  
47877 Willich Germany  
TEL : +49-215488-2831  
FAX : +49-215488-2834  
e-mail : sales@edimax-de.eu

#### **China Office**

Beijing Edimax Science & Technology Co., Ltd.  
17#1708,IDEAL Plaza,NO.111,  
ZhiChun Road, HaiDian District,  
Beijing,China  
TEL : +8610-82665815  
FAX : +8610-82665795  
e-mail : sales@edimax.com.cn

#### **Russia Office**

Edimax Technology Russia  
Fridriha Ehgelsa str., 75, bld. 3,  
105082 Moscow,Russia  
TEL : +7-495-9210239  
FAX : +7-495-9210239  
e-mail : sales@edimax.pl

#### **France Office**

EDIMAX Technology Europe B.V. FRANCE  
Marne-la-Vallée 6, rue de la Mare Blanche  
77186, NOISIEL, FRANCE  
TEL : +33 (0)1 60 53 56 80  
FAX : +33 (0)1 60 53 56 89  
e-mail : sales@edimax.fr

  
NETWORKING PEOPLE TOGETHER  
www.edimax.com