

B310s LTE CPE

Quick Start

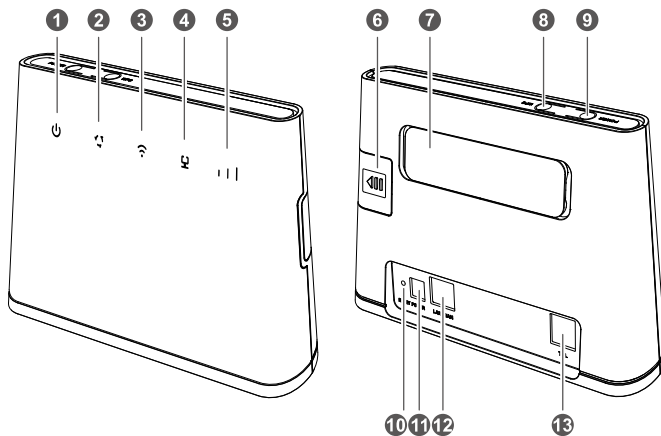

Getting to know your Router B310s



1



Power indicator

- On: the B310s is switched on.
- Off: the B310s is switched off.

2



Network mode indicator





- Steady cyan: connected to an LTE network.
- Steady green: connected to an Ethernet network.
- Steady red:
 - The SIM card is not recognised, the PIN has not been entered, or the PIN verification has failed.
 - Failed to connect to a mobile network or an Ethernet network.

3



Wi-Fi/WPS indicator

- Steady on: Wi-Fi turned on.
- Blinking: a WPS connection is being setup.
- Off: Wi-Fi turned off.

4	 LAN/WAN indicator	<ul style="list-style-type: none"> ● Steady on: LAN/WAN port connected to a LAN device or an Ethernet port. ● Blinking: data is being transmitted through the LAN/WAN port. ● Off: LAN/WAN port not connected to a LAN device or an Ethernet port.
5	 Signal strength indicator	<ul style="list-style-type: none"> ● On: signal reception available (3 Bars recommended for better reception). ● Off: no reception.
6	SIM card slot	Install a standard SIM card to access internet via an LTE data connection.
7	External antenna port	Connect to an external antenna after the removal of cover.
8	WPS button	Press and hold for 2 or more seconds until  is blinking to activate WPS connection when Wi-Fi is turned on.
9	Power button	Press and hold for about 3 seconds to power the B310s on or off.
10	Reset button	<p>● Restoring the default settings of the B310s will erase all previous settings.</p> <p>When the B310s is powered on, use a sharply pointed object to press and hold for about 3 seconds until  indicator is blinking to restore the B310s to its factory settings. After the factory defaults are restored, the B310s will restart automatically.</p>
11	Power port	Connect to a compatible power adapter.
12	LAN/WAN port	<ul style="list-style-type: none"> ● Working as a LAN port when connected to a computer, switch to any other LAN device. ● Working as a WAN port when connected to an Ethernet port.
13	Telephone port	Connect to a telephone.

1 Installation

Scenario 1: Accessing the Internet using an LTE network

Step 1: Installing the SIM card

1. Slide off the card slot cover.
2. Insert the SIM card into the card slot. Ensure that the slanted edge of the SIM card aligns with that of the card slot.
3. Close the card slot cover.

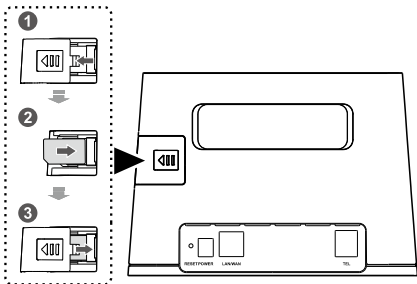

Do not remove the SIM card when it is in use. Doing so, will affect the performance of your router B310s.

Step 2: Connecting cables

-  To prevent interference caused by radio signals, place the B310s at least 1 meter (3.28 feet) away from telephone and other electrical devices.
- The B310s power adapter model is HW-120100XYW. X and Y represent letters or numbers that vary by region. For details about the specific adapter model, contact an authorised dealer.

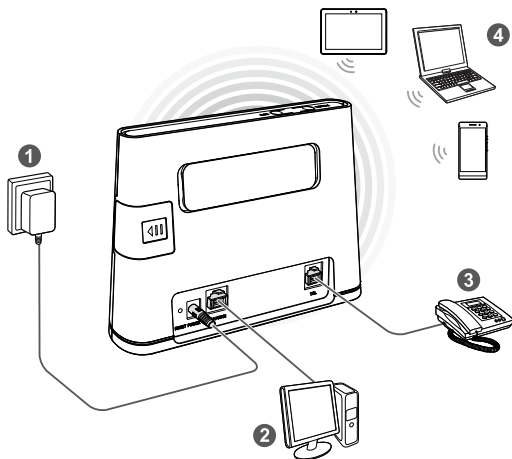

Once connected to a power outlet, press the power button as the Router B310s requires to be powered on manually

1	Power adapter	2	Computer
3	Telephone	4	Laptop, Tablet or Smartphone

 Do not connect the B310s to the telephone wall outlet (or any Public Switched Telephone Network), because doing so could damage the B310s due to excessive heat.

Installing the external antenna

- ⚠ Before installing the external antenna, ensure that the B310s is switched off and disconnected from the power outlet.
- Only use the external antenna indoors, and do not use it during a thunderstorm.
- Do not change another unexpected antenna unless it is provided by the manufacturer -

In areas with poor reception, connect external antenna to the Router B310s external antenna port to improve signal reception.

1. Power off the B310s and disconnect it from the power outlet.
2. Remove the cover from the antenna port. (Keep it in a safe place.)
3. Install one or two external antennas as needed. Make sure the external antennas are securely connected to the antenna ports.

If you are using only one external antenna, connect it to port 1.

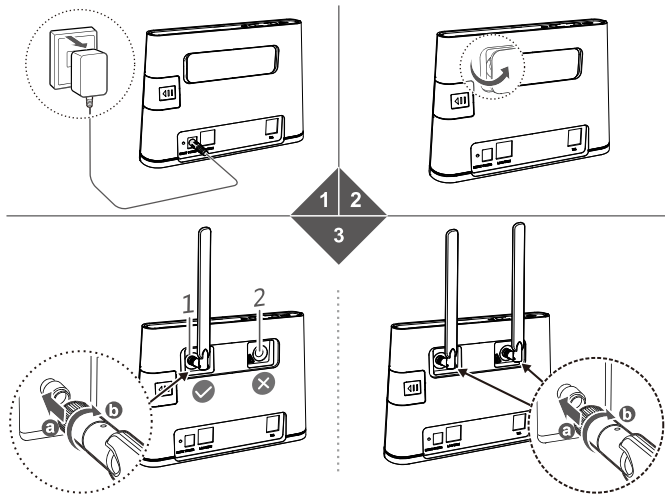

Scenario 2: Accessing the internet via multiple devices

Connect the B310s to an Ethernet port or an ADSL modem for internet access.

- 7 To prevent interference caused by radio signals, place the B310s at least 1 meter (3.28 feet) away from telephone and other electrical devices.
- The B310s power adapter model is HW-120100XYW. X and Y represent letters or numbers that vary by region. For details about the specific adapter model, contact an authorised dealer.

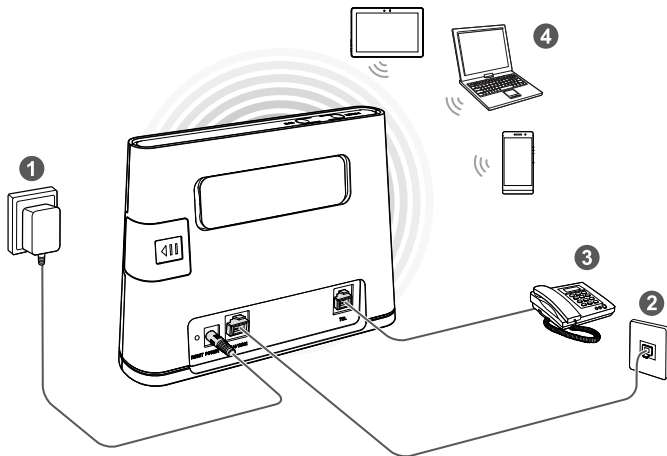

Once connected to a power outlet, the B310s automatically powers on.

- | | | | |
|---|---------------|---|-------------------------------|
| 1 | Power adapter | 2 | Ethernet port |
| 3 | Telephone | 4 | Laptop, Tablet, or Smartphone |

! Do not connect the B310s to the telephone wall outlet (or any Public Switched Telephone Network), because doing so could damage the B310s due to excessive heat.

2 Setting up a Wi-Fi connection

i Make sure your device (Computer, Tablet, or Smartphone) also supports Wi-Fi.

Step 1: Enabling Wi-Fi on the B310s

When the  indicator is steady on, the Wi-Fi function of the B310s is turned on.

i For details about how to manually enable or disable the Wi-Fi function, refer to the WLAN settings section of the help information on the web management page.

Step 2: Recording the SSID and Wi-Fi key

The default SSID and Wi-Fi key are printed on the B310s bottom label.

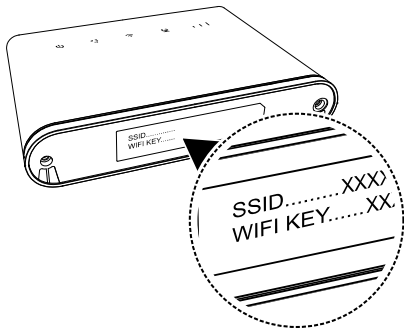

i To prevent unauthorised parties from accessing your Wi-Fi network, it is recommended that you change the SSID and Wi-Fi key from time to time. For details, see the help information on the web management page.

Step 3: Setting up a Wi-Fi connection on your device (computer, tablet, or smartphone) -

• Method 1: Setting up a Wi-Fi connection manually

1. From your Wi-Fi enabled device - scan for wireless networks in your area.
2. Connect to the network name that matches the SSID found on the device label.

- When prompted for password, enter the Wi-Fi Key found on the device label. (The Wi-Fi key is case sensitive.) Your device will notify you when it is connected.

Windows 7

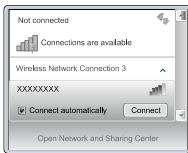

Windows 8



Mac

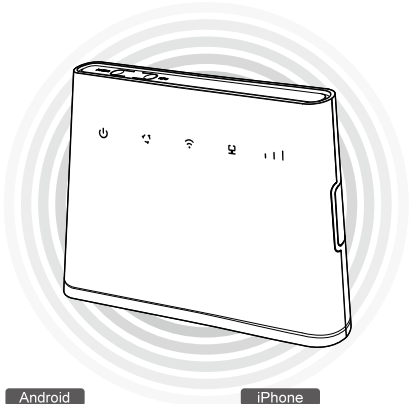
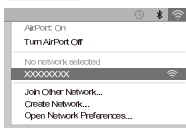

Android





iPhone



● Method 2: Reset Wi-Fi connection through WPS

If the device supports WPS, you can set up a WPS connection as follows:

- Ensure that Wi-Fi is enabled on the device.
- Press and hold the WPS button for 2 or more seconds. The  indicator then starts blinking.
- Activate the WPS connection on the device in 2 minutes.

 For instructions about how to enable a WPS connection on the client, see the device - user guide.

3 Configuring your B310s

1. After the device is connected to the B310s through Wi-Fi or LAN port, launch a browser on the client and visit **http://192.168.8.1**.
2. Enter the user name and password to log-in to the web management page.
The default user name and password are printed on the B310s bottom label.
3. Follow the quick setup wizard to check or set network connection parameters step by step. For details, see the help information on the web management page.
 -  ● To protect your account, change the password after your first log-in. For details see the help information on the web management page.
 - If you modify the SSID and Wi-Fi key, you must set up the Wi-Fi connection on the client again.

Once you are done, try opening a web page on the client to verify whether you have Internet access.

4 Changing SSID and Wi-Fi Key

Changing SSID and Wi-Fi

Changing the SSID

Choose Settings > WLAN > WLAN Basic Settings

In SSID, Enter the SSID.

Click Apply.

Changing the Wi-Fi Key

Choose Settings > WLAN > WLAN Basic Settings

In SSID, Enter Wi-Fi key.

In WPA pre-shared key, enter the security key. For example:-12345678.

Click Apply.

5 FAQ

- Am I getting a Wi-Fi router with the product?
 - Yes the Router (B310s) has the in-built Wi-Fi feature
- What should I do if I forget my Wi-Fi Key (Password)?
 - The Wi-Fi Key is available under the Router or call the Dialog Hotline on 117100100 and ask directions to reset
- How Can I do Relocation, if required?
 - Call the Dialog Hotline 117100100 for more details
- What are the devices which can be connected to my Router - (B310s)
 - PC/Switch/Router (Through Ethernet or LAN)
 - Wi-Fi enabled devices
 - Analog Phone/Fax
- Cannot take or -receive calls.
 - Ensure that the analog phone is in working condition and connected to the router (B310s) correctly.
 - Ensure you have purchased the Broadband + Voice Package.
Note.: Voice is not available for broadband only packages.
- How can I check my usage?

There are 2 ways to check your usage

 - Through the MY Account Portal on www.dialog.lk
 - Through the Dialog Self Care APP

- How do I request for additional data
 - Via SMS
 - To ADD 1 More:-
“BB<Space>1MORE<Space>Broadband Number” and send to 678
 - To ADD 10 More:-
“BB<Space>10MORE<Space>Broadband Number” and send to 678
 - Via the Self Care APP (for Dialog Mobile Customers)
 - Via the My Account Portal on www.dialog.lk

- How much -will - I be charged when requesting for additional data?
 - 1GB Block Rs. 200/- + Taxes*
 - 10GB block Rs. 1,000/- + Taxes*
 - *Prices are subject to change

- How do I upgrade or downgrade my package?
 - You can visit your nearest Dialog Customer Care Centre and request for an Upgrade or Downgrade (Rs. 1,000/- will be charged for Downgrades)***
 - *Prices are subject to change

- **Can I connect to my CCTV camera solution via my Dialog Home Broadband connection?**

Yes. If you are using the same Dialog network you do not need an IP, but if a different network is used to access the content, a public dynamic IP needs to be assigned to the router (B310s) to activate the port forwarding on the DVR (only for different ISP), public static IP is not required for CCTV.

- **How do I activate a Public Dynamic IP?**

You can visit your nearest Dialog Customer Service Centre outlet and request to include a Public Dynamic IP.

- **What is a Public Static IP used for?**

Public Static IP addresses are more reliable especially when hosting a gaming website. Use a Virtual Private Network for secure access to files from your company network computer. It is also good to use your computer as a server, as it should allow faster file uploads and downloads for your file server. You will be charged Rs. 1,500/- + taxes monthly*.

*Price is subject to change

Customer Service

Hotline : 117 100 100

Email : techsupport@dialog.lk

General Office

Dailog Broadband Networks (Pvt) Ltd. (PV 261)

No. 475, Union Place, Colombo 02

Sri Lanka

Tel +94 117 100 100 / FAX + 94 117 100 701

www.dialog.lk

6 Basic Trouble Shooting

- Internet Not Working
 - Check the power LED on your computer, router (B310s) unit.
 - Check if router (B310s) -Ethernet Cable is connected to your PC wired connectivity.
 - Check if Wi-Fi is enabled and connected to your Laptop or - Smartphone for wireless connectivity.
- Internet browsing speed is slow
 - Check PC or laptop meets the recommended requirement.
 - Check if your PC is performing heavy-duty downloads - (backups, virus scans)
 - Check if the router (B310s) signal if less than 3 bars (should be placed where signal strength is 3 bars)
- Wi-Fi Network cannot be detected on my Wi-Fi enabled device
 - Check whether the power adapters are correctly connected
 - Check if Wi-Fi is enabled on your device.

7 For more help

If you are experiencing any issues with the router B310:

- Restart the router B310s.
- Contact the Hotline on 117 100 100.

8 Safety information

This section contains important information about the operation of your device. It also contains information about how to use the device safely. Read this information carefully before using your device.

Electronic device

Do not use the device if doing so causes danger or interference with other electronic devices.

Interference with medical equipment

- Follow rules and regulations set forth by hospitals and health care facilities. Do not use your device where prohibited.
- Some wireless devices may affect the performance of hearing aids or pacemakers. Consult your service provider for more information.
- Pacemaker manufacturers recommend that a minimum distance of 15 cm to be maintained between a device and a pacemaker to prevent potential interference with the pacemaker. If using a pacemaker, hold the device on the side opposite the pacemaker and do not carry the device in your front pocket.

Areas with flammables and explosives

- Do not use the device where flammables or explosives are stored (For example: in a gas station, oil depot or chemical plant etc.-). Using your device in these environments increase the risk of explosion or fire. In addition, follow the instructions indicated in text or symbols.
- Do not store or transport the device in containers with flammable liquids, gases, or explosives.

Operating environment

- Avoid dusty, damp, or dirty environments. Avoid magnetic fields. Using the device in these environments may result in circuit malfunctions.
- Before connecting and disconnecting cables, stop using the device and disconnect it from the power supply. Ensure that your hands are dry during operation.
- Place the device on a stable surface.
- Keep the device away from electronic appliances that generate strong magnetic or electric fields, such as a microwave oven or refrigerator.
- During thunderstorms, power off your device and remove all cables connected to the router to protect against lightning strikes.
- Do not use your device during thunderstorms to protect your device against any danger caused by lightning.

- Ideal operating temperatures are 0°C to +40°C. Ideal storage temperatures are -20°C to +70°C. Extreme heat or cold may damage your device or accessories.
- Keep the device and accessories in a well-ventilated and cool area away from direct sunlight. Do not enclose or cover your device with towels or other objects. Do not place the device in a container with poor heat dissipation, such as a box or bag.
- To protect your device or accessories from fire or electrical shock hazards, avoid rain and moisture.
- Keep the device away from sources of heat and fire, such as a heater, microwave oven, stove, water heater, radiator, or candle.
- Do not place any object, such as a candle or a water container, on the router. If any foreign object or liquid enters the device, immediately stop using it, switch off power -, and remove all cables connected to it. Thereafter , contact an authorised service centre
- Do not block device openings. Reserve a minimum of 10 cm around the device to dissipate heat.
- Stop using your device or applications for a while if the device is overheated. If skin is exposed to an overheated device for an extended period, low temperature burn symptoms, such as red spots and darker pigmentation, may occur.
- Do not touch the device's antenna as communication quality may be affected
- Do not allow children or pets to bite or suck the device or accessories. Doing so may result in damage or explosion.
- Observe local laws and regulations, and respect the privacy and legal rights of others while using the router
- The router should be installed and operated with a minimum distance of 20 cm between the radiator and your body.
- Keep the device in a place with good reception. The distance between the router and other metal materials (such as metal brackets or metal doors and windows) should be greater than 25 cm (take off space) and the distance between the device should be greater than 30 cm. (take off space)

Child safety

- Comply with all precautions with regard to children's' safety. Letting children play with the router or its accessories may be dangerous. The router includes detachable parts that may present a choking hazard. Keep away from children.
- The router and its accessories are not intended for use by children. Children should only use the router with adult supervision.

Accessories

- Using an unapproved or incompatible power adapter, charger or battery may cause fire, explosion or other hazards.

- Choose only accessories approved for use with this model by the router device manufacturer. The use of any other types of accessories may void the warranty, may violate local regulations and laws, and may be dangerous.

Power adapter safety

- The power plug is intended to serve as a disconnect to the router -
- For pluggable devices, the socket-outlet shall be installed near the devices and shall be easily accessible.
- Unplug the power adapter from electrical outlets and the router when not in use.
- Do not drop or cause an impact to the power adapter. If it is damaged, take it to an authorised service centre for inspection.
- If the power cable is damaged (For- example: the cord is exposed or broken), or the plug loosens, stop using it at once. Continued use may lead to electric shocks, short circuits, or fire.
- Do not touch the power cord with wet hands or pull the power cord to disconnect the power adapter.
- Do not touch the device or the power adapter with wet hands. Doing so may lead to short circuits, malfunctions, or electric shocks.
- If your power adapter has been exposed to water, other liquids, or excessive moisture, take it to an authorised service center for inspection.
- Ensure that the power adapter meets the requirements of clause 2.5 in IEC60950-1/EN60950-1/UL60950-1 and has been tested and approved according to national or local standards.

Cleaning and maintenance

- During storage, transportation, and operation of the device, keep it dry and protect it from collision.
- Keep the device and accessories dry. Do not attempt to dry it with an external heat source, such as a microwave oven or hair dryer.
- Do not expose your device or accessories to extreme heat or cold. These environments may interfere with proper function and may lead to fire or explosion.
- Avoid collision, which may lead to device malfunctions, overheating, fire, or explosion.
- If the device is not going to be used for an extended period of time, switch off power -, and remove all cables connected to the router.
- If anything unusual occurs (For example: - if the device emits smoke or any unusual sound or smell), immediately stop using it, switch off power, remove all cables connected to it, and contact an authorised service center.
- Do not trample, pull, or excessively bend any cable. Doing so may damage the cable, causing the device to malfunction.

- Before you clean or maintain the device, stop using it, stop all applications, and disconnect all cables connected to it.
- Do not use any chemical detergent, powder, or any other chemical agents (such as alcohol and benzene) to clean the device or accessories. These substances may cause damage to parts or present a fire hazard. Use a clean, soft, and dry cloth to clean the device and accessories.
- Do not place magnetic stripe cards, such as credit cards and phone cards, near the device for extended periods of time as the magnetic stripes in the cards may be damaged.
- Do not dismantle or remanufacture the device and its accessories. This voids the warranty and releases the manufacturer from liability for damage. In case of damage, contact an authorised service center for assistance or repair.

Environmental protection

- The device and its accessories (if included), such as the power adapter, headset, and battery should not be disposed of with household garbage.
- Disposal of the device and its accessories is subject to local regulations. Support proper collection and recycling.

Disposal and recycling information



■ This symbol (with or without a solid bar) on the device, batteries (if included), and/or the packaging, indicates that the device and its electrical accessories (for example, a headset, adapter, or cable) and batteries should not be disposed of as household garbage. These items should not be disposed of as unsorted municipal waste and should be taken to a certified collection point for recycling or proper disposal.

For more detailed information about device or battery recycling, contact your local city office, household waste disposal service, or retail store.

Disposal of the device and batteries (if included) is subject to WEEE Directive Recast (Directive 2012/19/EU) and Battery Directive (Directive 2006/66/EC). The purpose of separating WEEE and batteries from other waste is to minimize the potential environmental impacts and human health risk of any hazardous substances that may be present.

Reduction of hazardous substances

This device is compliant with the REACH Regulation [Regulation (EC) No 1907/2006] and RoHS Directive Recast (Directive 2011/65/EU). Batteries (if included) are compliant with the Battery Directive (Directive 2006/66/EC). For up-to-date information about REACH and RoHS compliance, please visit the web site <http://consumer.huawei.com/certification>.

EU regulatory conformance

Statement

Hereby, Huawei Technologies Co., Ltd. declares that this device is in compliance with the essential requirements and other relevant provisions of Directive 1999/5/EC.

For the declaration of conformity, visit the web site

<http://consumer.huawei.com/certification>.

The following marking is included in the product:

CE0682

This device may be operated in all member states of the EU.

Observe national and local regulations where the device is used.

This device may be restricted for use, depending on the local network.

Restrictions in the 2.4 GHz band:

Norway: This subsection does not apply for the geographical area within a radius of 20 km from the centre of Ny-Ålesund.

9 Legal Notice

Copyright © Huawei Technologies Co., Ltd. 2015. All rights reserved.

No part of this manual may be reproduced or transmitted in any form or by any means without prior written consent of Huawei Technologies Co., Ltd. and its affiliates ("Huawei").

The product described in this manual may include copyrighted software of Huawei and possible licensors. Customers shall not in any manner reproduce, distribute, modify, decompile, disassemble, decrypt, extract, reverse engineer, lease, assign, or sublicense the said software, unless such restrictions are prohibited by applicable laws or such actions are approved by respective copyright holders.

Trademarks and Permissions



HUAWEI, **HUAWAI**, and



are trademarks or registered trademarks of Huawei Technologies Co., Ltd.

LTE is a trade mark of ETSI.

Other trademarks, product, service and company names mentioned may be the property of their respective owners.

Notice

Some features of the product and its accessories described herein rely on the software installed, capacities and settings of local network, and therefore may not be activated or may be limited by local network operators or network service providers.

Thus, the descriptions herein may not exactly match the product or its accessories which you purchase.

Huawei reserves the right to change or modify any information or specifications contained in this manual without prior notice and without any liability.

DISCLAIMER

ALL CONTENTS OF THIS MANUAL ARE PROVIDED "AS IS". EXCEPT AS REQUIRED BY APPLICABLE LAWS, NO WARRANTIES OF ANY KIND, EITHER EXPRESS OR IMPLIED, INCLUDING BUT NOT LIMITED TO, THE IMPLIED WARRANTIES OF MERCHANTABILITY AND FITNESS FOR A

PARTICULAR PURPOSE, ARE MADE IN RELATION TO THE ACCURACY, RELIABILITY OR CONTENTS OF THIS MANUAL.

TO THE MAXIMUM EXTENT PERMITTED BY APPLICABLE LAW, IN NO EVENT SHALL HUAWEI BE LIABLE FOR ANY SPECIAL, INCIDENTAL, INDIRECT, OR CONSEQUENTIAL DAMAGES, OR LOSS OF PROFITS, BUSINESS, REVENUE, DATA, GOODWILL SAVINGS OR ANTICIPATED SAVINGS REGARDLESS OF WHETHER SUCH LOSSES ARE FORSEEABLE OR NOT.

THE MAXIMUM LIABILITY (THIS LIMITATION SHALL NOT APPLY TO LIABILITY FOR PERSONAL INJURY TO THE EXTENT APPLICABLE LAW PROHIBITS SUCH A LIMITATION) OF HUAWEI ARISING FROM THE USE OF THE PRODUCT DESCRIBED IN THIS MANUAL SHALL BE LIMITED TO THE AMOUNT PAID BY CUSTOMERS FOR THE PURCHASE OF THIS PRODUCT.

Import and Export Regulations

Customers shall comply with all applicable export or import laws and regulations and be responsible to obtain all necessary governmental permits and licenses in order to export, re-export or import the product mentioned in this manual including the software and technical data therein.

Privacy Policy

To better understand how we protect your personal information, please see the privacy policy at <http://consumer.huawei.com/privacy-policy>.