

LINKSYS[®]
A Division of Cisco Systems, Inc.



Broadband Router

with 2 Phone Ports

VoIP
Voice

Installation and Troubleshooting Guide

Model No. **RTP300**



Copyright and Trademarks

Specifications are subject to change without notice. Linksys is a registered trademark or trademark of Cisco Systems, Inc. and/or its affiliates in the U.S. and certain other countries. Copyright © 2005 Cisco Systems, Inc. All rights reserved. Other brands and product names are trademarks or registered trademarks of their respective holders.

WARNING: This product contains chemicals, including lead, known to the State of California to cause cancer, and birth defects or other reproductive harm. *Wash hands after handling.*

How to Use this Guide

Your guide to the Broadband Router with 2 Phone Ports has been designed to make understanding networking with the Router easier than ever. Look for the following items when reading this guide:



This exclamation point means there is a caution or warning and is something that could damage your property or the Router.



This question mark provides you with a reminder about something you might need to do while using the Router.



This checkmark means there is a note of interest and is something you should pay special attention to while using the Router.

In addition to these symbols, there are definitions for technical terms that are presented like this:

***word:** definition.*

Also, each figure (diagram, screenshot, or other image) is provided with a figure number and description, like this:

Figure 0-1: Sample Figure Description

Figure numbers and descriptions can also be found in the “List of Figures” section.

RTP300-VD-UG-50422NC JL

Broadband Router with 2 Phone Ports

Table of Contents

Chapter 1: Introduction	1	The Applications & Gaming Tab - Port Triggering	34
Welcome	1	The Applications & Gaming Tab - DMZ	36
What's in this Guide?	2	The Applications & Gaming Tab - QoS	37
Chapter 2: Networking Basics	5	The Administration Tab - Management	39
An Introduction to Local Area Networks	5	The Administration Tab - Log	40
The Use of IP Addresses	5	The Administration Tab - Factory Defaults	41
Chapter 3: Getting to Know the Router	7	The Administration Tab - Diagnostics	42
The Back Panel	7	The Status Tab - Router	43
The Front Panel	8	The Status Tab - Local Network	45
Chapter 4: Connecting the Router	9	The Status Tab - Voice	46
Overview	9	The Voice Tab	47
Connecting the Router to Your Broadband Modem	9	Appendix A: Troubleshooting	49
Connecting the Router to Your Existing Router	11	Common Problems and Solutions	49
Placement Options	13	Frequently Asked Questions	63
Chapter 5: Configuring the Router	15	Appendix B: Finding the MAC Address and IP Address for Your Ethernet Adapter	69
Overview	15	Windows 98 or Me Instructions	69
How to Access the Web-based Utility	18	Windows 2000 or XP Instructions	70
The Setup Tab - Basic Setup	19	For the Router's Web-based Utility	70
The Setup Tab - DDNS	23	Appendix C: Windows Help	71
The Setup Tab - MAC Address Clone	25	Appendix D: Glossary	73
The Setup Tab - Advanced Routing	26	Appendix E: Specifications	79
The Security Tab - Firewall	28	Appendix F: Warranty Information	81
The Security Tab - VPN Passthrough	29	Appendix G: Regulatory Information	83
The Access Restrictions Tab - Filter	30	Appendix H: Contact Information	85
The Access Restrictions Tab - Device Access Control	32		
The Applications & Gaming Tab - Port Range Forwarding	33		

Broadband Router with 2 Phone Ports

List of Figures

Figure 3-1: Back Panel	7	Figure 5-13: Access Restrictions Tab - Filter	30
Figure 3-2: Front Panel	8	Figure 5-14: Filtered MAC Address	30
Figure 4-1: Connect the Modem	9	Figure 5-15: Access Restrictions Tab - Device Access Control	32
Figure 4-2: Connect a PC	9	Figure 5-16: Applications & Gaming Tab - Port Range Forwarding	33
Figure 4-3: Connect the Power	10	Figure 5-17: Applications & Gaming Tab - Port Triggering	34
Figure 4-4: Connect a Telephone	10	Figure 5-18: Applications & Gaming Tab - DMZ	36
Figure 4-5: Router Connected to Another Router	11	Figure 5-19: Applications & Gaming Tab - QoS	37
Figure 4-6: Connect the Existing Router	12	Figure 5-20: QoS - Create Rule	38
Figure 4-7: Connect the Power	12	Figure 5-21: Administration Tab - Management	39
Figure 4-8: Connect a Telephone	12	Figure 5-22: Administration Tab - Log	40
Figure 4-9: Attaching the Stand (Optional)	13	Figure 5-23: Administration Tab - Factory Defaults	41
Figure 4-10: Measurement between Wall-Mount Slots	14	Figure 5-24: Administration Tab -Diagnostics	42
Figure 5-1: Router's IP Address	18	Figure 5-25: Ping Test	42
Figure 5-2: Router Login	18	Figure 5-26: Traceroute Test	42
Figure 5-3: Setup Tab - Basic Setup (Obtain an IP automatically)	19	Figure 5-27: Status Tab - Router	43
Figure 5-4: Static IP	20	Figure 5-28: Status Tab - Local Network	45
Figure 5-5: PPPoE	21	Figure 5-29: DHCP Active IP Table	45
Figure 5-6: Setup Tab - DDNS (DynDNS.org)	24	Figure 5-30: Status Tab - Voice	46
Figure 5-7: Setup Tab - DDNS (TZO.com)	24	Figure 5-31: Voice Tab	47
Figure 5-8: Setup Tab - MAC Address Clone	25	Figure B-1: IP Configuration Screen	69
Figure 5-9: Setup Tab - Advanced Routing	26	Figure B-2: MAC/Adapter Address	69
Figure 5-10: Routing Table Entry List	27	Figure B-3: MAC/Physical Address	70
Figure 5-11: Security Tab - Firewall	28	Figure B-4: MAC Address Clone	70
Figure 5-12: Security Tab - VPN Passthrough	29	Figure B-5: MAC Address Filter	70

Broadband Router with 2 Phone Ports

Chapter 1: Introduction

Welcome

Thank you for choosing the Broadband Router with 2 Phone Ports. This Router will allow your computers to share a high-speed Internet connection as well as resources, including files and printers. And after you have set up your Internet phone service, you will be able to make phone or fax calls using the Internet.

How does the Router do all of this? By connecting your computers and peripherals, including phones or fax machines, to the Router and connecting the Router to your cable or DSL modem, then the Router can direct and control communications for your network.

But what does all of this mean?

Networks are useful tools for sharing Internet access and computer resources. Multiple computers can share Internet access, so you don't need more than one high-speed Internet connection. With Internet phone service, your Internet access can now be shared by your phones or fax machines as well. You will be able to make phone calls using the account you set up with your Internet phone service provider, even while you're surfing the Internet. Plus, you can access one printer from different computers and access data located on another computer's hard drive. Networks are even used for playing multiplayer video games. So, networks not only are useful in homes and offices, but also can be fun.

PCs on a wired network create a LAN, or Local Area Network. They are connected with Ethernet cables, which is why the network is called "wired".

To create your network, install and set up the Router. To guide you through the process, Linksys strongly recommends that you run the Setup Wizard on the Setup CD-ROM. If you prefer to manually set up the Router,

nat (network address translation): NAT technology translated IP addresses of a local area network to a different IP address for the Internet.

mbps: one million bits per second; a unit of measurement for data transmission.

browser: an application program that provides a way to look at and interact with all the information on the World Wide Web.

lan (local area network): the computers and networking products that make up the network in your home or office.

ethernet: an IEEE standard network protocol that specifies how data is placed on and retrieved from a common transmission medium.

Broadband Router with 2 Phone Ports

use the instructions in this Installation and Troubleshooting Guide to help you. These instructions should be all you need to get the most out of the Router.

What's in this Guide?

This guide covers the basic steps for setting up a network with a router. After going through "Chapter 3: Getting to Know the Router," most users will only need to use the following chapters:

- **Chapter 4: Connecting the Router**
This chapter instructs you on how to connect the Router to your cable or DSL modem, PCs, and telephones (or fax machines).
- **Chapter 5: Configuring the Router**
This chapter explains how to configure the Router using your web browser and the Router's Web-based Utility. You will configure the Router using the settings provided by your ISP.

When you're finished with the basic steps, then you are ready to connect to the Internet.

You also have other chapters available for reference:

- **Chapter 1: Introduction**
This chapter describes the Router's applications and this Installation and Troubleshooting Guide.
- **Chapter 2: Networking Basics**
This chapter briefly explains how a network functions.
- **Appendix A: Troubleshooting**
This appendix describes some possible problems and solutions, as well as frequently asked questions, regarding installation and use of the Router.

- **Appendix B: Finding the MAC Address and IP Address for Your Ethernet Adapter**
This appendix instructs you on how to find the MAC address or Ethernet address of your PC's Ethernet network adapter.
- **Appendix C: Windows Help**
This appendix describes how you can use Windows Help for instructions about networking, such as installing the TCP/IP protocol.
- **Appendix D: Glossary**
This appendix gives a brief glossary of terms frequently used in networking.
- **Appendix E: Specifications**
This appendix provides the technical specifications for the Router.
- **Appendix F: Warranty Information**
This appendix supplies the warranty information for the Router.
- **Appendix G: Regulatory Information**
This appendix supplies the regulatory information regarding the Router.
- **Appendix H: Contact Information**
This appendix provides contact information for a variety of Linksys resources, including Technical Support.

Broadband Router with 2 Phone Ports

Chapter 2: Networking Basics

An Introduction to Local Area Networks

Simply put, a router is a network device that connects two networks together.

The Router connects your local area network (LAN), or the group of PCs in your home or office, to the Internet. The Router processes and regulates the data that travels between these two networks.

The Router's Network Address Translation (NAT) technology protects your network of PCs so users on the Internet cannot "see" your PCs. This is how your LAN remains private. The Router protects your network by inspecting the first packet coming in through the Internet port before delivery to the final destination on one of the Ethernet ports. The Router inspects Internet port services like the web server, ftp server, or other Internet applications, and, if allowed, it will forward the packet to the appropriate PC on the LAN side.

***nat (network address translation):** NAT technology translates IP addresses of a local area network to a different IP address for the Internet.*

The Use of IP Addresses

IP stands for Internet Protocol. Every device in an IP-based network, including PCs, print servers, and routers, requires an IP address to identify its location, or address, on the network. This applies to both the Internet and LAN connections.

There are two ways of assigning IP addresses to your network devices.

A static IP address is a fixed IP address that you assign manually to a PC or other device on the network. Since a static IP address remains valid until you disable it, static IP addressing ensures that the device assigned it will always have that same IP address until you change it. Static IP addresses are commonly used with network devices such as server PCs or print servers.

***static ip address:** a fixed address assigned to a computer or device that is connected to a network.*

Broadband Router with 2 Phone Ports

If you use the Router to share your cable or DSL Internet connection, contact your ISP to find out if they have assigned a static IP address to your account. If so, you will need that static IP address when configuring the Router. You can get the information from your ISP.

A dynamic IP address is automatically assigned to a device on the network. These IP addresses are called dynamic because they are only temporarily assigned to the PC or other device. After a certain time period, they expire and may change. If a PC logs onto the network (or the Internet) and its dynamic IP address has expired, the DHCP server will assign it a new dynamic IP address.

A DHCP server can either be a designated PC on the network or another network device, such as the Router. By default, the Router's Internet Connection Type is **Obtain an IP automatically** (DHCP).

The PC or network device obtaining an IP address is called the DHCP client. DHCP frees you from having to assign IP addresses manually every time a new user is added to your network.

For DSL users, many ISPs may require you to log on with a user name and password to gain access to the Internet. This is a dedicated, high-speed connection type called Point to Point Protocol over Ethernet (PPPoE). PPPoE is similar to a dial-up connection, but PPPoE does not dial a phone number when establishing a connection. It also will provide the Router with a dynamic IP address to establish a connection to the Internet.

By default, a DHCP server (on the LAN side) is enabled on the Router. If you already have a DHCP server running on your network, you **MUST** disable one of the two DHCP servers. If you run more than one DHCP server on your network, you will experience network errors, such as conflicting IP addresses. To disable DHCP on the Router, see the Basic Setup section in "Chapter 5: Configuring the Router."

***dynamic ip address:** a temporary IP address assigned by a DHCP server.*

***dhcp** (dynamic host configuration protocol): a protocol that lets one device on a local network, known as a DHCP server, assign temporary IP addresses to the other network devices, typically computers.*

Chapter 3: Getting to Know the Router

The Back Panel

The Router's ports and the Reset button are located on the back panel of the Router.



Figure 3-1: Back Panel

Internet	This Internet port connects to your cable or DSL modem.
Phone1	For your primary Internet phone line, the Phone1 port allows you to connect the Router to your telephone (or fax machine) using an RJ-11 telephone cable (not included).
Phone2	If you have a second Internet phone line, the Phone2 port allows you to connect the Router to your second telephone (or fax machine) using an RJ-11 telephone cable (not included).
Ethernet 1-4	These four Ethernet ports connect to network devices, such as PCs or more switches.
Reset Button	There are two ways to reset the Router's factory defaults. Either press the Reset Button for five seconds, or restore the defaults from the Router's Web-based Utility.
Power	The Power port is where you will connect the power adapter.



NOTE: The Internet port only accepts a straight-through cable. Do NOT connect a crossover cable to the Internet port.



NOTE: The Voice Factory Default feature of the Router's Web-based Utility is protected by a password available only from your Internet phone service provider. Contact your provider for more information.

The Front Panel

The Router's LEDs, which inform you about network activities, are located on the front panel.

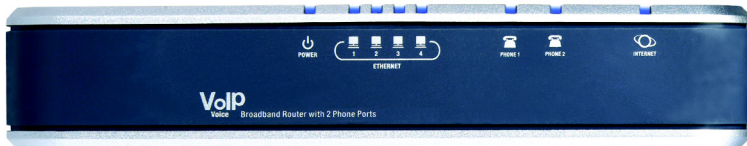

Figure 3-2: Front Panel

POWER	Blue/Red. The POWER LED lights up blue when the Router is powered on. If the blue LED is flashing, the Router is booting up or upgrading its firmware. If the LED lights up red, then disconnect the power, and wait five seconds. Then reconnect the power.
ETHERNET 1-4	Blue. The ETHERNET LED lights up when there is an active connection through the corresponding port. If the LED is flashing, then there is traffic moving through that port.
PHONE 1-2	Blue. The PHONE LED is solidly lit when a telephone or fax machine has an active or registered connection to your Internet phone service provider through the corresponding port (PHONE 1 or 2). It flashes when the phone is being used or is off the hook.
INTERNET	Blue. The INTERNET LED lights up when the Router is connected to your cable or DSL modem. If the LED is flashing, the Router is sending or receiving data over the Internet port.

Proceed to "Chapter 4: Connecting the Router."

Chapter 4: Connecting the Router

Overview

This chapter includes two sets of instructions. If the Broadband Router with 2 Phone Ports will be the only router in your network, follow the instructions in “Connecting the Router to Your Broadband Modem.” If you already have a router in your network and want to add the Broadband Router with 2 Phone Ports, follow the instructions in “Connecting the Router to Your Existing Router.”



NOTE: Make sure your telephone is set to its tone setting (not pulse).

Connecting the Router to Your Broadband Modem

1. Make sure that your devices are powered off, including the Router, PCs, and broadband modem.
2. Connect your broadband modem’s Ethernet cable to the Router’s Internet port.
3. Connect one end of an Ethernet network cable to one of the numbered ports on the back of the Router. Connect the other end to an Ethernet port on a network device, e.g., a PC, print server, or switch.

Repeat this step to connect more PCs or other network devices to the Router.



Figure 4-1: Connect the Modem



Figure 4-2: Connect a PC

Broadband Router with 2 Phone Ports

4. Power on the broadband modem.
5. Connect the included power adapter to the Router's Power port, and then plug the power adapter into an electrical outlet. The Power LED on the front panel will light up as soon as the Router powers on.
6. Plug a standard telephone into the Router's Phone1 port.



IMPORTANT: Do not connect the Phone port to a telephone wall jack. Make sure you only connect a telephone or fax machine to the Phone port. Otherwise, the Router or the telephone wiring in your home or office may be damaged.

7. If you have a second Internet phone or fax line, connect a telephone or fax machine to the Router's Phone2 port.
8. Power on your PC(s).

If you want to mount the Router on a wall, proceed to the following section, "Placement Options." Otherwise, proceed to "Chapter 5: Configuring the Router."



Figure 4-3: Connect the Power



Figure 4-4: Connect a Telephone

Connecting the Router to Your Existing Router

Linksys recommends that you replace your existing router with the Broadband Router with 2 Phone Ports. However, if you would like to keep your existing router because it has wireless capability or other features, then you can use the following instructions to connect the Broadband Router with 2 Phone Ports to your existing router, while keeping your wired PCs connected to your existing router. For example, the following connection diagram shows the Broadband Router with 2 Phone Ports connected to your existing router and phone.

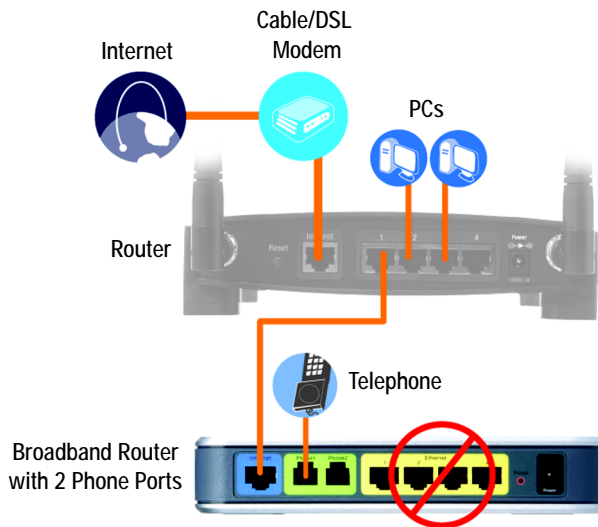

Figure 4-5: Router Connected to Another Router

Chapter 4: Connecting the Router
Connecting the Router to Your Existing Router



NOTE: Do NOT connect any wired PCs to the Broadband Router with 2 Phone Ports.

Broadband Router with 2 Phone Ports

To connect the Broadband Router with 2 Phone Ports to your existing router, follow these instructions:

1. Connect an Ethernet cable to the Internet port on the back of the Broadband Router with 2 Phone Ports. Then connect the other end to one of the Ethernet network ports on your existing router.
2. Connect the included power adapter to the Power port of the Broadband Router with 2 Phone Ports, and then plug the power adapter into an electrical outlet. The Power LED on the front panel will light up as soon as the Broadband Router with 2 Phone Ports powers on.



IMPORTANT: Do not connect the Phone port to a telephone wall jack. Make sure you only connect a telephone or fax machine to the Phone port. Otherwise, the Router or the telephone wiring in your home or office may be damaged.

3. Plug a standard telephone into the Phone1 port of the Broadband Router with 2 Phone Ports.
4. If you have a second Internet phone or fax line, connect a telephone or fax machine to the Phone2 port.

Proceed to the following section, "Placement Options."



Figure 4-6: Connect the Existing Router



Figure 4-7: Connect the Power



Figure 4-8: Connect a Telephone

Placement Options

There are three ways to place the Router. The first way is to place it horizontally on a surface, so it sits on its four rubber feet. The second way is to stand the Router vertically on a surface (this uses an optional stand). The third way is to mount it on a wall. The second and third options are explained in further detail below.

Stand Option

If you have the optional stand, then you can place the Router vertically on a surface.

1. Line up the center of the Router's stand with the center of the Router's labeled edge.
2. Insert the Router into the stand.

Proceed to "Chapter 5: Configuring the Router."

Broadband Router with 2 Phone Ports



Figure 4-9: Attaching the Stand (Optional)

Wall-Mount Option

The Router has four wall-mount slots on its bottom panel. The distance between two adjacent slots is 62 mm (2.44 inches).

Before you begin, make sure you have four screws that are size #4—this indicates a diameter measurement of 0.112 inches (2.845 mm).

1. Determine where you want to mount the Router.
2. Drill four holes into the wall. Make sure adjacent holes are 62 mm (2.44 inches) apart.
3. Insert a screw into each hole, and leave 5 mm (0.2 inches) of its head exposed.
4. Maneuver the Router so the wall-mount slots line up with the four screws.
5. Place the wall-mount slots over the screws and slide the Router down until the screws fit snugly into the wall-mount slots.

Proceed to “Chapter 5: Configuring the Router.”

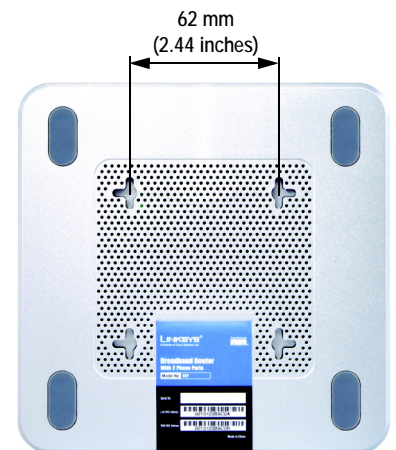

Figure 4-10: Measurement between Wall-Mount Slots

Chapter 5: Configuring the Router

Overview

Linksys recommends using the Setup CD-ROM for first-time installation of the Router. If you do not wish to run the Setup Wizard on the Setup CD-ROM, then you can use the Web-based Utility to configure the Router. For advanced users, you may configure the Router's advanced settings through the Web-based Utility.

This chapter will describe each web page on the Utility and each page's key functions. The Utility can be accessed via your web browser through use of a computer connected to the Router. For a basic network setup, most users only have to use the following screens of the Utility:

- **Basic Setup.** On the *Basic Setup* screen, enter the Internet connection settings provided by your ISP. If you do not have this information, you can call your ISP to request the settings. Once you have the setup information for your specific type of Internet connection, then you can configure the Router.
- **Management.** Click the **Administration** tab and then the **Management** tab. The Router's default user name and password is **admin**. To secure the Router, change the User Name and Password from their defaults.

There are seven main tabs: Setup, Security, Access Restrictions, Applications & Gaming, Administration, Status, and Voice. Additional tabs will be available after you click one of the main tabs.

Setup

- **Basic Setup.** Enter the Internet connection and network settings on this screen.
- **DDNS.** Enable the Router's Dynamic Domain Name System (DDNS) feature on this screen.
- **MAC Address Clone.** If you need to clone a MAC address onto the Router, use this screen.
- **Advanced Routing.** On this screen, you can alter firewall, Network Address Translation (NAT), Dynamic Routing, and Static Routing configurations.

Security

- **Firewall.** To enable certain types of web filters, use this screen.
- **VPN Passthrough.** To enable or disable IPSec, PPPoE, and/or PPTP Passthrough, use this screen.

Access Restrictions

- **Filter.** To block specific users from Internet access, you can set up IP address, port, and MAC address filtering.
- **Device Access Control.** Use this screen to control remote access of the Router.

Applications & Gaming

- **Port Range Forwarding.** Set up public services or other specialized Internet applications on your network.
- **Port Triggering.** To set up triggered ranges and forwarded ranges for Internet applications, click this tab.
- **DMZ.** Click this tab to allow one local user to be exposed to the Internet for use of special-purpose services.
- **QoS.** Enable QoS (Quality of Service) to maximize network performance.

Administration

- **Management.** On this screen, alter the Router's user name, password, and UPnP settings.
- **Log.** If you want to view or save activity logs, click this tab.
- **Factory Defaults.** If you want to reset the Router to its router factory default settings, then use this screen. If you want to reset the Router to its voice factory default settings, then you will need a password available only from your Internet phone service provider. Contact your provider for more information.
- **Diagnostics.** If you want to run a ping or traceroute test, use this screen.

Status

- **Router.** This screen provides status information about the Router.
- **Local Network.** This provides status information about the local network.
- **Voice.** This screen provides status information about your Internet phone line(s).

Voice

Access to the Voice tab is restricted by your Internet phone service provider. Contact your provider for more information.

How to Access the Web-based Utility

To access the Web-based Utility of the Router, launch Internet Explorer or Netscape Navigator, and enter the Router's default IP address, **192.168.15.1**, in the *Address* field. Press the **Enter** key.

The *Login* screen will appear asking you for your User name and Password. Enter **admin** in the *User Name* and *Password* fields. Then click the **Log In** button. Click the **Cancel** button to exit the *Login* screen.

Make the necessary changes through the Utility. When you have finished making changes to a screen, click the **Save Settings** button to save the changes, or click the **Cancel Changes** button to undo your changes. Help information is shown on the right-hand side of a screen. For additional help on a tab, click **More**.



Figure 5-1: Router's IP Address



Figure 5-2: Router Login

The Setup Tab - Basic Setup

The *Basic Setup* screen is the first screen you see when you access the Web-based Utility.

Internet Setup

The Internet Setup section configures the Router for your Internet connection type. This information can be obtained from your ISP.

Internet Connection Type

The Router supports three connection types: Obtain an IP automatically, Static IP, and PPPoE. Each *Basic Setup* screen and available features will differ depending on what kind of connection type you select.

Obtain an IP automatically

By default, the Router's Internet Connection Type is set to **Obtain an IP automatically**, and it should be used only if your ISP supports DHCP or you are connecting through a dynamic IP address.

Broadband Router with 2 Phone Ports

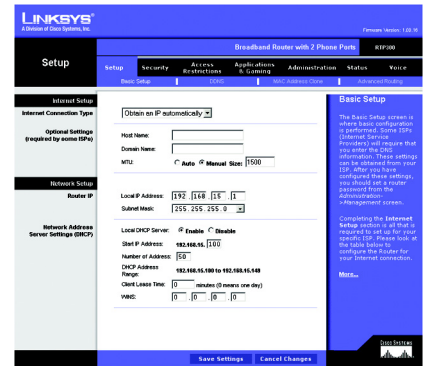

Figure 5-3: Setup Tab - Basic Setup (Obtain an IP automatically)

Static IP

If you are required to use a permanent IP address, then select **Static IP**.

IP Address. This is the IP address that the Router has, when seen from the Internet. Your ISP will provide you with the IP Address you need to specify here.

Subnet Mask. This is the Router's Subnet Mask, as seen by external users on the Internet (including your ISP). Your ISP will provide you with the Subnet Mask.

Gateway. Your ISP will provide you with the Default Gateway Address.

DNS 1-3. Your ISP will provide you with at least one DNS (Domain Name System) Server IP Address.

WINS. The Windows Internet Naming Service (WINS) converts NetBIOS names to IP addresses. If you use a WINS server, enter that server's IP address here. Otherwise, leave this field blank.

PPPoE

Some DSL-based ISPs use PPPoE (Point-to-Point Protocol over Ethernet) to establish Internet connections for end-users. If you use a DSL line, check with your ISP to see if they use PPPoE. If they do, you will have to enable it.

User Name and Password. Enter the User Name and Password provided by your ISP.

Connect on Demand and Keep Alive. You can configure the Router to cut the Internet connection after it has been inactive for a specific period of time (Idle Timeout). If your Internet connection has been terminated due to inactivity, Connect on Demand enables the Router to automatically re-establish your connection as soon as you attempt to access the Internet again. If you wish to activate Connect on Demand, click the radio

The screenshot shows a configuration window titled "Static IP". It contains several rows of input fields, each with a label on the left and four small boxes for digits on the right. The labels and their corresponding digit boxes are:

- IP Address: [0] [0] [0] [0]
- Subnet Mask: [0] [0] [0] [0]
- Gateway: [0] [0] [0] [0]
- DNS 1: [0] [0] [0] [0]
- DNS 2: [0] [0] [0] [0]
- DNS 3: [0] [0] [0] [0]
- WINS: [0] [0] [0] [0]

Figure 5-4: Static IP

static ip address: a fixed address assigned to a computer or device connected to a network.

subnet mask: an address code that determines the size of the network.

default gateway: a device that forwards Internet traffic from your local area network.

pppoe: a type of broadband connection that provides authentication (username and password) in addition to data transport.

button. If you want your Internet connection to remain on at all times, enter **0** in the *Idle Timeout* field. Otherwise, enter the number of minutes you want to have elapsed before your Internet access disconnects.

Keep Alive and Redial Period. This option keeps your Internet access connected indefinitely, even when it sits idle. If you select this option, the Router will periodically check your Internet connection. If the connection is down, then the Router will automatically re-establish the connection. To use this option, click the radio button next to *Keep Alive*. The default Redial Period is **60** seconds.

When you are finished, click the **Save Settings** button. Then click the **Status** tab, and click the **Connect** button to start the connection.

Optional Settings

Some of these settings may be required by your ISP. Verify with your ISP before making any changes.

Host Name and Domain Name. These fields allow you to supply a host and domain name for the Router. Some ISPs require these names as identification. You may have to check with your ISP to see if your broadband Internet service has been configured with a host and domain name. In most cases, leaving these fields blank will work.

MTU. The MTU (Maximum Transmission Unit) setting specifies the largest packet size permitted for network transmission. Select **Auto** to have the Router automatically select the MTU value, or select **Manual** and enter the value desired. It is recommended that you leave this value in the 1200 to 1500 range. For two Internet connection types, Obtain an IP automatically and Static IP, the MTU's default value is **1500**. For PPPoE, the MTU's default value is **1492**.

Network Setup

The Network Setup section allows you to change the Router's local network settings.

Chapter 5: Configuring the Router
The Setup Tab - Basic Setup

Broadband Router with 2 Phone Ports

PPPoE

User Name:

Password:

Connect on Demand: Idle Timeout Min.

Keep Alive: Redial Period Sec.

Figure 5-5: PPPoE



NOTE: For DSL users, if you need to enable PPPoE support, remember to remove any PPPoE applications that are installed on your PCs.

packet: a unit of data sent over a network.

Broadband Router with 2 Phone Ports

Router IP

The values for the Router's Local IP Address and Subnet Mask are shown here. In most cases, keeping the default values will work.

Local IP Address. The default value is **192.168.15.1**.

Subnet Mask. The default value is **255.255.255.0**.

Network Address Server Settings (DHCP)

These settings allow you to configure the Router's Dynamic Host Configuration Protocol (DHCP) server function. The Router can be used as a DHCP server for your network. A DHCP server automatically assigns an IP address to each computer on your network. Unless you already have one, it is highly recommended that you leave the Router enabled as a DHCP server.

Local DHCP Server. DHCP is enabled by factory default. If you already have a DHCP server on your network, set the Router's DHCP option to **Disable**. If you disable DHCP, remember to assign a static IP address to the Router.

Start IP Address. Enter a value for the DHCP server to start with when issuing IP addresses. Because the default IP address for the Router is 192.168.15.1, the Start IP Address must be 192.168.15. 101 or greater, but smaller than 192.168.15.254. The default Start IP Address is **192.168.15.100**.

Number of Address (Optional). Enter the maximum number of PCs that you want the DHCP server to assign IP addresses to. This number cannot be greater than 253. The default is **50**.

DHCP Address Range. The range of DHCP addresses is displayed here.

Client Lease Time. The Client Lease Time is the amount of time a network user will be allowed connection to the Router with their current dynamic IP address. Enter the amount of time, in minutes, that the user will be “leased” this dynamic IP address. After the dynamic IP address has expired, the user will be automatically assigned a new dynamic IP address. The default is **0** minutes, which means one day.

dynamic ip address: a temporary IP address assigned by a DHCP server.

WINS. The Windows Internet Naming Service (WINS) converts NetBIOS names to IP addresses. If you use a WINS server, enter that server’s IP address here. Otherwise, leave this field blank.

When you have finished making changes to this screen, click the **Save Settings** button to save the changes, or click the **Cancel Changes** button to undo your changes.



NOTE: To test your settings, connect to the Internet now.

The Setup Tab - DDNS

The Router offers a Dynamic Domain Name System (DDNS) feature. DDNS lets you assign a fixed host and domain name to a dynamic Internet IP address. It is useful when you are hosting your own website, FTP server, or other server behind the Router.

ddns: allows the hosting of a website, FTP server, or e-mail server with a fixed domain name (e.g., www.xyz.com) and a dynamic IP address.

Before you can use this feature, you need to sign up for DDNS service at one of two DDNS service providers, DynDNS.org or TZO.com. If you do not want to use this feature, keep the default setting, **Disable**.

DDNS

DDNS Service. If you use DynDNS.org, then select **DynDNS.org**. If you use TZO, then select **TZO.com**. The features available on the *DDNS* screen will vary, depending on which DDNS service provider you use.

Broadband Router with 2 Phone Ports

DynDNS.org

User Name, Password, and Host Name. Enter the User Name, Password, and Host Name of the account you set up with DynDNS.org.

Internet IP Address. The Router's current Internet IP Address is displayed here. Because it is dynamic, this will change.

Status. The status of the DDNS service connection is displayed here.

TZO.com

E-mail Address, Password, and Domain Name. Enter the Email Address, Password, and Domain Name of the service you set up with TZO.

Internet IP Address. The Router's current Internet IP Address is displayed here. Because it is dynamic, this will change.

Status. The status of the DDNS service connection is displayed here.

When you have finished making changes to this screen, click the **Update** button to save the changes, or click the **Cancel Changes** button to undo your changes.



Figure 5-6: Setup Tab - DDNS (DynDNS.org)

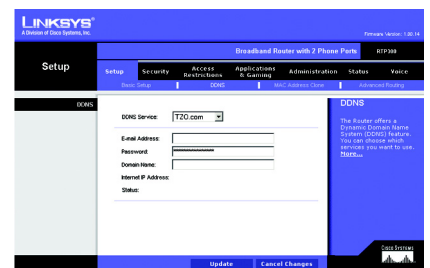

Figure 5-7: Setup Tab - DDNS (TZO.com)

The Setup Tab - MAC Address Clone

A MAC address is a 12-digit code assigned to a unique piece of hardware for identification, like a social security number. Some ISPs will require you to register a MAC address in order to access the Internet. If you do not wish to re-register the MAC address with your ISP, you may assign the MAC address you have currently registered with your ISP to the Router with the MAC Address Clone feature.

MAC Clone

MAC Clone Service. To use MAC address cloning, select **Enable**.

MAC Address. Enter the MAC Address registered with your ISP. Then click the **Save Settings** button.

Clone. If you want to clone the MAC address of the PC you are currently using to configure the Router, then click the **Clone** button. The Router will automatically detect your PC's MAC address, so you do NOT have to call your ISP to change the registered MAC address to the Router's MAC address. It is recommended that the PC registered with the ISP is used to open the *MAC Address Clone* screen.

When you have finished making changes to this screen, click the **Save Settings** button to save the changes, or click the **Cancel Changes** button to undo your changes.

Broadband Router with 2 Phone Ports

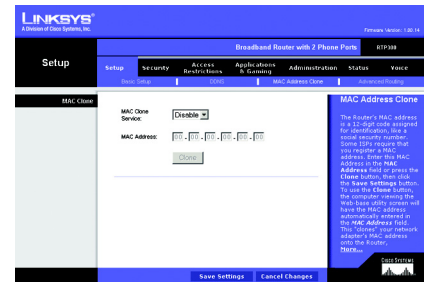

Figure 5-8: Setup Tab - MAC Address Clone

mac address: the unique address that a manufacturer assigns to each networking device.

The Setup Tab - Advanced Routing

The *Advanced Routing* screen allows you to configure the firewall, Network Address Translation (NAT), dynamic routing, and static routing settings.

Advanced Routing

Firewall & NAT. The Stateful Packet Inspection (SPI) firewall reviews data packets entering your network. NAT is a security feature that enables the Router to translate IP addresses of your local area network to a different IP address for the Internet. These features are enabled by default. To disable the firewall and NAT, click the **Disable** radio button. (When NAT is disabled, the DHCP server feature is also disabled.)

Dynamic Routing. This feature enables the Router to automatically adjust to physical changes in the network's layout and exchange routing tables with the other router(s). The Router determines the network packets' route based on the fewest number of hops between the source and the destination. To enable Dynamic Routing, click the **Enable** radio button. To disable this feature, click the **Disable** radio button.

Transmit RIP Version. To use dynamic routing for transmission of network data, select the protocol you want, **RIP1 v1**, **RIP1 v1 Compatible**, or **RIP v2**.

Static Routing. Use this feature to set up a static router between the Router and another network. (A static route is a pre-determined pathway that network information must travel to reach a specific host or network.) To create a static route, alter the following settings:

Select Entry. Select the number of the static route from the drop-down menu. The Router supports up to 20 static route entries.

Destination LAN IP. The Destination LAN IP Address is the address of the remote network or host to which you want to assign a static route. Enter the IP address of the host for which you wish to create a static route.

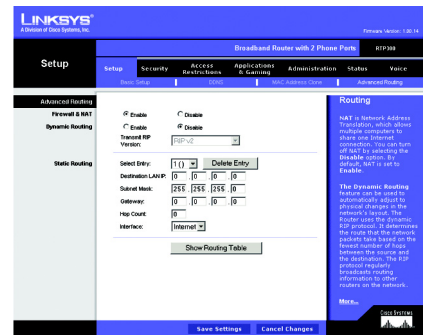

Figure 5-9: Setup Tab - Advanced Routing

Subnet Mask. The Subnet Mask determines which portion of a Destination IP address is the network portion, and which portion is the host portion.

Gateway. This is the IP address of the gateway device that allows for contact between the Router and the remote network or host.

Hop Count. This determines the maximum number of steps between network nodes that data packets will travel. A node is any device on the network, such as PCs, print servers, routers, etc.

Interface. Select **Local** or **Internet**, depending on the location of the static route's final destination.

Delete Entry. If you need to delete a route, select its number from the drop-down menu, and click the **Delete Entry** button.

Show Routing Table. Click the **Show Routing Table** button to open a screen displaying how data is routed through your local network. For each route, the Destination LAN IP address, Default Gateway, Subnet Mask, Flags, Metric, Ref (Reference), User, and Interface are displayed. Click the **Refresh** button to update the information.

When you have finished making changes to this screen, click the **Save Settings** button to save the changes, or click the **Cancel Changes** button to undo your changes.

Destination LAN IP	Default Gateway	Subnet Mask	Flags	Metric	Ref	Use Interface
192.168.10.0	0.0.0.0	255.255.255.0	0	0	0	eth0
192.0.0.0	0.0.0.0	255.0.0.0	0	1	0	eth0
0.0.0.0	64.101.101.1	0.0.0.0	80	0	0	eth0

Figure 5-10: Routing Table Entry List

The Security Tab - Firewall

When you click the Security tab, you will see the *Firewall* screen. You can use this screen to enable a variety of web filters, which will enhance the firewall protecting your network.

Web Filters

Filter Proxy. Use of WAN proxy servers may compromise the Gateway's security. Denying Filter Proxy will disable access to any WAN proxy servers. To enable proxy filtering, click the checkbox.

Filter Java Applets. Java is a programming language for websites. If you deny Java Applets, you run the risk of not having access to Internet sites created using this programming language. To enable Java Applet filtering, click the checkbox.

Filter Cookies. A cookie is data stored on your computer and used by Internet sites when you interact with them. To enable cookie filtering, click the checkbox.

Filter ActiveX. ActiveX is a programming language for websites. If you deny ActiveX, you run the risk of not having access to Internet sites created using this programming language. To enable ActiveX filtering, click the checkbox.

When you have finished making changes on this screen, click the **Save Settings** button to save the changes, or click the **Cancel Changes** button to undo your changes.

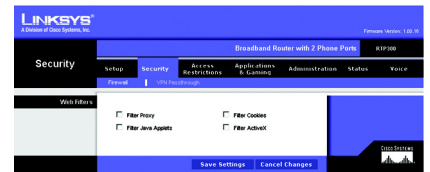

Figure 5-11: Security Tab - Firewall

The Security Tab - VPN Passthrough

The *VPN Passthrough* screen allows you to allow VPN tunnels using IPSec, PPPoE, or PPTP protocols to pass through the Router.

VPN Passthrough

IPSec Passthrough. IPSec (Internet Protocol Security) is a suite of protocols used to implement secure exchange of packets at the IP layer. To allow IPSec Passthrough, click the **Enabled** button. To disable IPSec Passthrough, click the **Disabled** button.

PPPoE Passthrough. PPPoE (Point-to-Point over Ethernet) Passthrough allows your PC(s) to use the PPPoE client software provided by your ISP. Some ISPs may request that you use this feature on the Router. To allow PPPoE Passthrough, click the **Enabled** button. To disable PPPoE Passthrough, click the **Disabled** button.

PPTP Pass Through. PPTP (Point-to-Point Tunneling Protocol) Passthrough allows the Point-to-Point (PPP) to be tunneled through an IP network. To allow PPTP Passthrough, click the **Enabled** button. To disable PPTP Passthrough, click the **Disabled** button.

When you have finished making changes on this screen, click the **Save Settings** button to save the changes, or click the **Cancel Changes** button to undo your changes.

Broadband Router with 2 Phone Ports

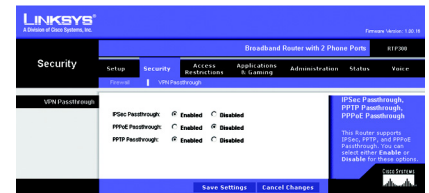

Figure 5-12: Security Tab - VPN Passthrough

The Access Restrictions Tab - Filter

Filters can block specific internal users from accessing the Internet, anonymous Internet requests, and/or multicasting.

Filter IP Address Range

You can create up to five different IP Address filters. To set up a filter, enter the IP address you wish to filter in the field provided. Users who have filtered IP addresses will not be able to access the Internet at all.

Filter Port Range

You can create up to five different Port Range filters. To filter users by network port number, select the protocol you want to filter, **TCP**, **UDP**, or **Both**, from the *Protocol* drop-down menu. Enter the port numbers you want to filter in the *Start* and *End* fields. Users connected to the Router will no longer be able to access any port number listed there.

Filter MAC Address

This feature blocks computers with specific MAC addresses from going out to the Internet. For information on obtaining a MAC address, go to "Appendix C: Finding the MAC Address and IP Address for Your Ethernet Adapter." To set the MAC filter, click the **Edit MAC Filter Setting** button.

Edit MAC Filter Setting. Click the **Edit MAC Filter Setting** button. Select the range of MAC address entries in the drop-down box. In each *mac* field, enter the MAC address you want to filter. Click the **Apply** button before closing the window. To cancel changes, click the **Undo** button.

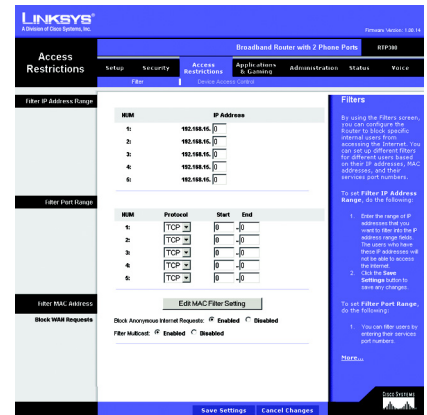

Figure 5-13: Access Restrictions Tab - Filter

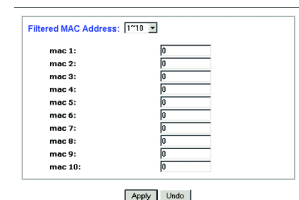

Figure 5-14: Filtered MAC Address

Block WAN Requests

Use these features to enhance your network's security and filter multicasting.

Block Anonymous Internet Requests. This keeps your network from being "pinged" or detected and reinforces your network security by hiding your network ports, so it is more difficult for intruders to work their way into your network. Select **Enabled** to block anonymous Internet requests, or **Disabled** to allow anonymous Internet requests.

Filter Multicast. Multicasting allows for multiple transmissions to specific recipients at the same time. If multicasting is permitted, then the Router will allow IP multicast packets to be forwarded to the appropriate computers. Select **Enabled** to filter multicasting, or **Disabled** to disable this feature.

When you have finished making changes to this screen, click the **Save Settings** button to save the changes, or click the **Cancel Changes** button to undo your changes.

The Access Restrictions Tab - Device Access Control

Use this screen to control local and remote access to the Router's management ports via different services.

Access Control

Enable Access Control. If you want to control access to the Router's management ports via the services listed below, click the checkbox. For each service, make sure the appropriate checkbox is checked if you want to allow local or remote access. Make sure the appropriate checkbox is not checked if you want to block local or remote access.

If the Access Control feature is disabled, then access is permitted within the local network but blocked for the Internet.

Service Name. You can control access for two services, Web and Secure Shell (SSH).

WAN. If you want to block WAN (Internet) access for a service, make sure the appropriate checkbox is unchecked. If you want to allow access, then make sure the appropriate checkbox is checked.

LAN. If you want to block local access for a service, make sure the appropriate checkbox is unchecked. If you want to allow access, then make sure the appropriate checkbox is checked.

IP Access List. Specify the IP addresses that are allowed to remotely access the Router. If you want to delete an IP address, select it and then click the **Delete** checkbox.

New IP. To add an IP address, enter it in the field provided, and then click the **Add** checkbox.

When you have finished making changes to this screen, click the **Save Settings** button to save the changes, or click the **Cancel Changes** button to undo your changes.



Figure 5-15: Access Restrictions Tab - Device Access Control



NOTE: When a checkbox for a service is checked, access is enabled. When a checkbox is unchecked, access is denied.

The Applications & Gaming Tab - Port Range Forwarding

When you click the Applications & Gaming tab, you will see the *Port Range Forwarding* screen. Port Range Forwarding sets up public services on your network, such as web servers, ftp servers, e-mail servers, or other specialized Internet applications. (Specialized Internet applications are any applications that use Internet access to perform functions such as videoconferencing or online gaming. Some Internet applications may not require any forwarding.) When users send this type of request to your network via the Internet, the Router will forward those requests to the appropriate PC.

Before using forwarding, you should assign a static IP address to the designated PC.

If you need to forward all ports to one PC, click the **DMZ** tab.

Port Range Forwarding

Port Range

To add a server using Port Range Forwarding, complete the following fields:

Application. Enter the name of the application.

Start and End. Enter the number or range of external port(s) used by the server or Internet application. Check with the Internet application software documentation for more information.

Protocol. Select the protocol **TCP** or **UDP**, or select **Both**.

IP Address. Enter the IP address of the server that you want the Internet users to be able to access. To find the IP address, go to "Appendix C: Finding the MAC Address and IP Address for Your Ethernet Adapter."

Broadband Router with 2 Phone Ports

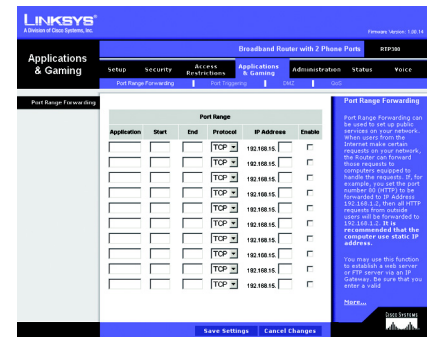

Figure 5-16: Applications & Gaming Tab - Port Range Forwarding

tcp: a network protocol for transmitting data that requires acknowledgement from the recipient of data sent.

udp: a network protocol for transmitting data that does not require acknowledgement from the recipient of the data that is sent.

ip (internet protocol): a protocol used to send data over a network.

ip address: the address used to identify a computer or device on a network.

Broadband Router with 2 Phone Ports

Enable. Check the **Enable** box to enable the services you have defined. Port Range Forwarding will not function if the Enabled button is left unchecked. This is disabled (unchecked) by default.

When you have finished making changes to this screen, click the **Save Settings** button to save the changes, or click the **Cancel Changes** button to undo your changes.

The Applications & Gaming Tab - Port Triggering

The *Port Triggering* screen allows the Router to watch outgoing data for specific port numbers. The IP address of the computer that sends the matching data is remembered by the Router, so that when the requested data returns through the Router, the data is pulled back to the proper computer by way of IP address and port mapping rules.

Port Triggering

Application. Enter the application name of the trigger.

Triggered Range

For each application, list the triggered port number range. Check with the Internet application documentation for the port number(s) needed.

Start Port. Enter the starting port number of the Triggered Range.

End Port. Enter the ending port number of the Triggered Range.

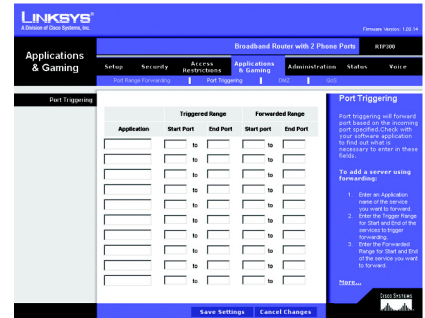

Figure 5-17: Applications & Gaming Tab - Port Triggering

Forwarded Range

For each application, list the forwarded port number range. Check with the Internet application documentation for the port number(s) needed.

Start Port. Enter the starting port number of the Forwarded Range.

End Port. Enter the ending port number of the Forwarded Range.

When you have finished making changes to this screen, click the **Save Settings** button to save the changes, or click the **Cancel Changes** button to undo your changes.

The Applications & Gaming Tab - DMZ

The *DMZ* screen allows one local user to be exposed to the Internet for use of a special-purpose service such as Internet gaming and videoconferencing. DMZ hosting forwards all the ports at the same time to one PC. The Port Range Forwarding is more secure because it only opens the ports you want to have opened, while DMZ hosting opens all the ports of one computer, exposing the computer to the Internet.

Any PC whose port is being forwarded must have its DHCP client function disabled and should have a new static IP address assigned to it because its IP address may change when using the DHCP function.

DMZ

DMZ. To use this feature, select **Enabled**. To disable DMZ hosting, select **Disabled**.

DMZ Host IP Address. To expose one PC, enter the computer's IP address. To get the IP address of a computer, refer to "Appendix C: Finding the MAC Address and IP Address for Your Ethernet Adapter." Deactivate DMZ by entering a **0** in the field.

When you have finished making changes to this screen, click the **Save Settings** button to save the changes, or click the **Cancel Changes** button to undo your changes.

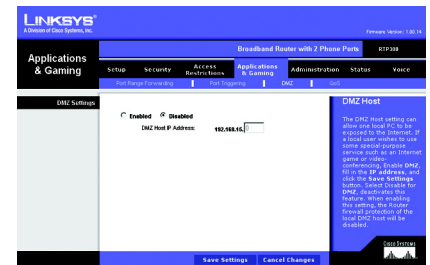

Figure 5-18: Applications & Gaming Tab - DMZ

The Applications & Gaming Tab - QoS

Quality of Service (QoS) ensures better service to high-priority types of network traffic, which may involve demanding, real-time applications, such as Internet phone calls or videoconferencing.

Use this screen to configure IP QoS for connections, view the rules you have set up, and manage your rules.

IP QoS

Choose a connection. Choose the appropriate connection from the drop-down menu.

Low priority weight. Select the weight of the low priority queue, which is available in increments of 10%. The sum of the low and medium priority weights should equal 100%.

Medium priority weight. Select the weight of the medium priority queue, which is available in increments of 10%. The sum of the low and medium priority weights should equal 100%.

Enable IP QoS. Click this checkbox to enable IP QoS for the selected connection.

Trusted Mode. The Router has two modes for management of queue traffic. Click the **Trusted Mode** checkbox if you want the Router to apply all of the IP QoS rules first, regardless of the TOS bit settings. After the rules have been applied, then the TOS bit settings will be applied. If Trusted Mode is not used, then the Router will use the un-trusted mode. The default rule will be applied if there is no match between the un-trusted mode and the rules of the Trusted Mode. (The default rule will assign a low queuing priority.)

The following table will list the rules you have configured. You can also add new rules and delete existing rules. Each rule uses the criteria you specified to identify specific types of application traffic, which should be assigned to one of the Router's three priority queues: High, Medium, or Low.

Broadband Router with 2 Phone Ports

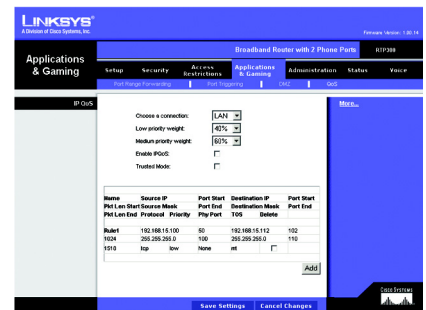

Figure 5-19: Applications & Gaming Tab - QoS



NOTE: If IP QoS is enabled and you have no defined rules, then a default rule will be implemented. All traffic will be transmitted in the Low priority queue.

Broadband Router with 2 Phone Ports

To create a rule, follow these instructions:

1. Click the **Add** button located below the table of rules.
2. A new screen will appear. Enter a name in the *Rule Name* field.
3. Identify the application traffic by providing the following information: Source IP, Source Netmask, Source Start and End Ports, Destination IP, Destination Netmask, Destination Start and End ports, and Packet Length Start and End settings.

For the IP, Netmask, and Port fields, you can enter wildcard (*) entries.

4. Select the appropriate protocol: **TCP**, **UDP**, **ICMP**, or **Any**.
5. Select the appropriate port, **None**, **Eth 0** (Ethernet), or **WLAN**, from the *Physical Port* drop-down menu.
6. Select the appropriate traffic priority: **Low**, **Medium**, or **High**.
7. Assign a Type Of Service (TOS) value to this traffic. You can click the **Normal Service** checkbox or select a value from the *TOS Marking* drop-down menu: **No change**, **Minimize monetary cost**, **Maximize reliability**, **Maximize throughput**, or **Minimize delay**.
8. To save your new rule, click the **Save Settings** button. To cancel your changes, click the **Cancel Changes** button.

After you create a rule, it will be displayed in the list on the *IP QoS* screen. If you want to delete a rule, click its **Delete** checkbox and then click the **Save Settings** button.

When you have finished making changes to this screen, click the **Save Settings** button to save the changes, or click the **Cancel Changes** button to undo your changes.

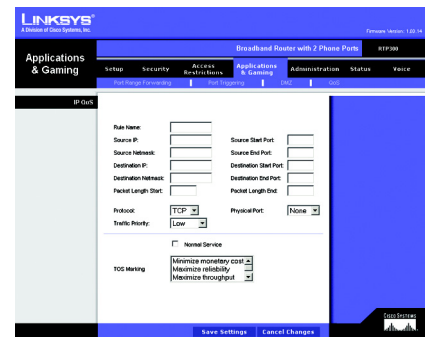

Figure 5-20: QoS - Create Rule

The Administration Tab - Management

When you click the Administration tab, you will see the *Management* screen. This screen allows you to change the Router's access settings as well as configure the UPnP (Universal Plug and Play) feature.

Router Password

Local Router Access

To ensure the Router's security, you will be asked for your user name and password when you access the Router's Web-based Utility. The default user name and password is **admin**.

User Name. It is recommended that you change the default user name to one of your choice.

Router Password. It is recommended that you change the default password to one of your choice.

Re-enter to confirm. Re-enter the Router's new Password to confirm it.

Idle Timeout. When you use the Router's Web-based Utility, your session can remain idle for a specified length of time. Enter the length of time you want to allow. The default is **10** minutes.

UPnP

UPnP. UPnP allows Windows Me or XP to automatically configure the Router for various Internet applications, such as gaming and videoconferencing. To enable UPnP, click the **Enabled** radio button. To disable this feature, click the **Disabled** radio button.

When you have finished making changes to this screen, click the **Save Settings** button to save the changes, or click the **Cancel Changes** button to undo your changes.

Broadband Router with 2 Phone Ports

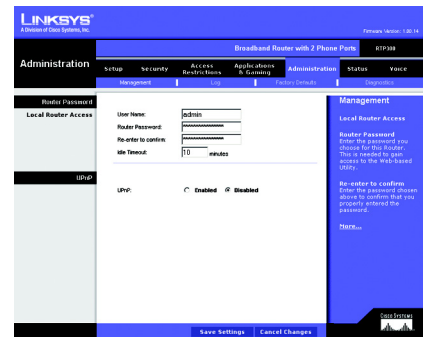

Figure 5-21: Administration Tab - Management

The Administration Tab - Log

When you click the Administration tab, you will see the *Log* screen. You can select which PC will receive the specified type of system logs for your Internet connection.



NOTE: The PC that receives these logs must be running a SYSLOG application. Linksys offers free software that can view system logs. You can download Logviewer software at www.linksys.com.

Log

Log Level. There are a variety of log levels available, from most urgent to least urgent. Select the appropriate level: **Panic**, **Alert**, **Critical**, **Error**, **Warning**, **Notice**, **Info**, or **Debug**, from the drop-down menu.

Add an IP Address. In this field, enter the fixed IP address of the PC that will receive the logs. Then click the **Add** button. The Router will now send updated logs to that PC.

Select a logging destination. If you add an IP address, then that IP address automatically becomes the logging destination. If you want to delete a destination, then select it and click the **Delete** button.

When you have finished making changes to this screen, click the **Save Settings** button to save the changes, or click the **Cancel Changes** button to undo your changes.

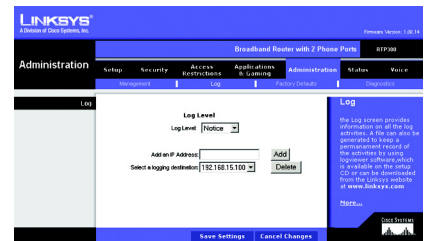

Figure 5-22: Administration Tab - Log

The Administration Tab - Factory Defaults

The *Factory Defaults* screen allows you to reset the Router to its router factory defaults. If you want to reset the Router to its voice factory defaults, then you need a password available only from your Internet phone service provider. Contact your provider for more information.

Factory Defaults

Restore Router Factory Defaults. If you wish to reset the Router to its router factory defaults, click the **Yes** radio button and then the **Save Settings** button. Then follow the on-screen instructions.



NOTE: Any custom settings you have saved will be lost when the default settings are restored, so before you restore the router factory defaults, write down any settings you may need later.

Restore Voice Factory Defaults. If you click the **Yes** radio button and then the **Save Settings** button, you will see a screen asking for a password. Enter the password provided by your Internet phone service provider, and follow the on-screen instructions.

When you have finished making changes to this screen, click the **Save Settings** button to save the changes, or click the **Cancel Changes** button to undo your changes.

Broadband Router with 2 Phone Ports

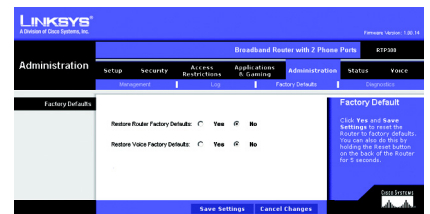

Figure 5-23: Administration Tab - Factory Defaults

The Administration Tab - Diagnostics

The diagnostic tests allow you to check the connections of your network components.

Ping Test

Ping Parameters. The Ping test will check the status of a connection. Click the **Ping** button to open the *Ping Test* screen. Enter the IP address or domain name of the PC whose connection you wish to test. Enter the size of the test packet. Then select the number of times you want the ping to occur. Click the **Ping** button. The *Ping Test* screen will then display the test results. Click the **Close** button to return to the *Diagnostics* screen.

Traceroute Test

Traceroute Parameters. To test the performance of a connect, click the **Traceroute** button. Enter the IP address or domain name of the PC whose connection you wish to test. Click the **Traceroute** button. The *Traceroute Test* screen will then display the test results. Click the **Close** button to return to the *Diagnostics* screen.

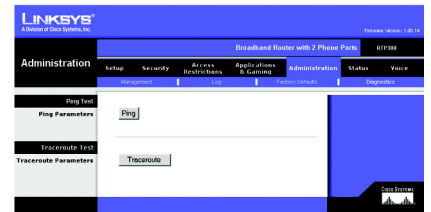

Figure 5-24: Administration Tab - Diagnostics

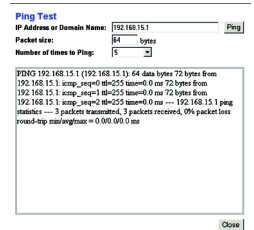

Figure 5-25: Ping Test

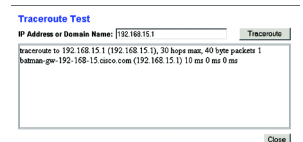

Figure 5-26: Traceroute Test

The Status Tab - Router

The *Router* screen displays information about the Router and its current settings. The on-screen information will vary depending on the Internet Connection Type selected on the *Setup* screen.

Information

Firmware Version. This shows the version number of the installed firmware.

Current Time. The current time and date are displayed here when the Router is connected to the Internet.

MAC Address. The MAC Address of the Router's Internet interface is displayed here. (When you sign up for your Internet phone service account, you will need to provide the MAC address of the Router.)

Status

Login Type. This indicates the type of Internet connection you are using.

Login Status. The status is displayed only for the dial-up style connection, PPPoE. There is a Connect button to click if there is no Internet connection and you want to re-connect.

Internet IP Address. The Router's Internet IP Address is displayed here.

Subnet Mask and Default Gateway. The Router's Subnet Mask and Default Gateway address are displayed here for DHCP and static IP connections.

DNS 1-3. Shown here are the DNS (Domain Name System) IP addresses currently used by the Router.

MTU. Shown here is the MTU value currently used by the Router.

Chapter 5: Configuring the Router
The Status Tab - Router

Broadband Router with 2 Phone Ports



Figure 5-27: Status Tab - Router

Broadband Router with 2 Phone Ports

DHCP Release. Available for a DHCP connection, click the **DHCP Release** button to release the current IP address of the device connected to the Router's Internet port.

DHCP Renew. Available for a DHCP connection, click the **DHCP Renew** button to replace the current IP address—of the device connected to the Router's Internet port—with a new IP address.

Click the **Refresh** button to update the on-screen information.

The Status Tab - Local Network

The *Local Network* screen displays information about the local network.

Local Network

MAC Address. The MAC Address of the Router's LAN (local area network) interface is displayed here.

IP Address. The Router's local IP Address is shown here.

Subnet Mask. The Router's Subnet Mask is shown here.

DHCP Server. The status of the DHCP server is displayed here.

DHCP Clients Table. Click the **DHCP Clients Table** button to view a list of PCs that have been assigned IP addresses by the Router. The *DHCP Active IP Table* screen lists the DHCP Server IP Address, Client Host Names, IP Addresses, MAC Addresses, and Lease Times. Click the **Refresh** button to update the information. Click the **Close** button to close this screen.

Click the **Refresh** button to update the on-screen information.

Broadband Router with 2 Phone Ports

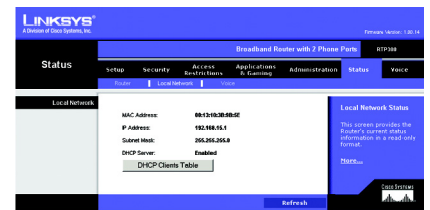
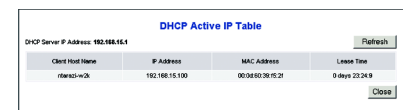

Figure 5-28: Status Tab - Local Network



Client Host Name	IP Address	MAC Address	Lease Time
rtmcs-wk	192.168.15.100	00:04:00:20:1c:2f	0 days 22:24:9

Figure 5-29: DHCP Active IP Table

The Status Tab - Voice

The *Voice* screen displays information about your Internet phone line(s).

Information

Provisioning Status. This status information indicates whether the Router has been configured by your Internet phone service provider.

Line1 Status

Registration Status. The phone number and status of this Internet phone line are displayed here. If it is not registered, then you should register it. If registration has failed, then refer to “Appendix A: Troubleshooting.”

Call1 Status. The status of the active phone call is shown here.

Call2 Status. If you are using call waiting, the status of the incoming phone call is shown here.

Line2 Status

Registration Status. The phone number and status of this Internet phone line are displayed here. If it is not registered, then you should register it. If registration has failed, then refer to “Appendix A: Troubleshooting.”

Call1 Status. The status of the active phone call is shown here.

Call2 Status. If you are using call waiting, the status of the incoming phone call is shown here.

Click the **Refresh** button to update the on-screen information.

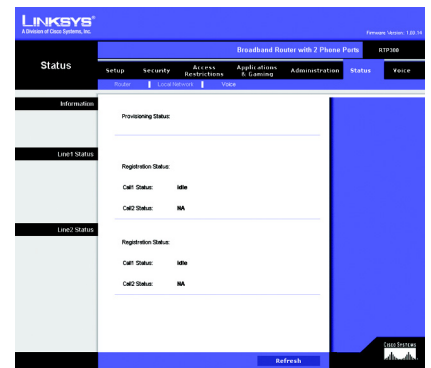

Figure 5-30: Status Tab - Voice

The Voice Tab

Access to the Voice tab is restricted by your Internet phone service provider. Contact your provider for more information.

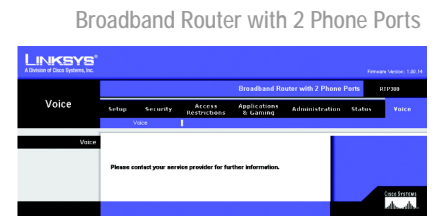

Figure 5-31: Voice Tab

Broadband Router with 2 Phone Ports

Appendix A: Troubleshooting

This appendix provides solutions to problems that may occur during the installation and operation of the Router. Read the description below to solve your problems. If you can't find an answer here, check the your Internet phone service provider's website or the Linksys website at www.linksys.com.

Common Problems and Solutions

1. *I don't hear a dial tone, and the PHONE1 (or PHONE2) LED is not lit.*

Go through this checklist until your problem is solved:

- Make sure the telephone is plugged into the appropriate port, Phone 1 or Phone 2.
- Disconnect and re-connect the RJ-11 telephone cable between the Router and telephone.
- Make sure your telephone is set to its tone setting (not pulse).
- Make sure your network has an active Internet connection. Try to access the Internet, and check to see if the Router's Internet LED is lit. If you do not have a connection, power off your network devices, including the Router and cable/DSL modem. Wait 30 seconds, and power on the cable/DSL modem first. Then power on the Router and other network devices.
- Verify your account information and confirm that the phone line is registered with your Internet phone service provider.

2. *I'm trying to access the Router's Web-based Utility, but I do not see the login screen. Instead, I see a screen saying, "404 Forbidden."*

If you are using Windows Explorer, perform the following steps until you see the Web-based Utility's login screen (Netscape Navigator will require similar steps):

- A. Click **File**. Make sure *Work Offline* is NOT checked.

Broadband Router with 2 Phone Ports

- B. Press **CTRL + F5**. This is a hard refresh, which will force Windows Explorer to load new webpages, not cached ones.
- C. Click **Tools**. Click **Internet Options**. Click the **Security** tab. Click the **Default level** button. Make sure the security level is Medium or lower. Then click the **OK** button.

3. *I need to set a static IP address on a PC.*

The Router, by default, assigns an IP address range of 192.168.15.100 to 192.168.15.150 using the DHCP server on the Router. To set a static IP address, you can only use the ranges 192.168.15.2 to 192.168.15.99 and 192.168.15.151 to 192.168.15.254. Each PC or network device that uses TCP/IP must have a unique address to identify itself in a network. If the IP address is not unique to a network, Windows will generate an IP conflict error message. You can assign a static IP address to a PC by performing the following steps:

For Windows 98 and Millennium:

- A. Click **Start**, **Setting**, and **Control Panel**. Double-click **Network**.
- B. In *The following network components are installed* box, select the **TCP/IP->** associated with your Ethernet adapter. If you only have one Ethernet adapter installed, you will only see one TCP/IP line with no association to an Ethernet adapter. Highlight it and click the **Properties** button.
- C. In the *TCP/IP properties* window, select the **IP address** tab, and select **Specify an IP address**. Enter a unique IP address that is not used by any other computer on the network connected to the Router. You can only use an IP address in the ranges 192.168.15.2 to 192.168.15.99 and 192.168.15.151 to 192.168.15.254. Make sure that each IP address is unique for each PC or network device.
- D. Click the **Gateway** tab, and in the *New Gateway* prompt, enter **192.168.15.1**, which is the default IP address of the Router. Click the **Add** button to accept the entry.
- E. Click the **DNS** tab, and make sure the **DNS Enabled** option is selected. Enter the Host and Domain names (e.g., John for Host and home for Domain). Enter the DNS entry provided by your ISP. If your ISP has not provided the DNS IP address, contact your ISP to get that information or go to its website for the information.

- F. Click the **OK** button in the *TCP/IP properties* window, and click **Close** or the **OK** button for the *Network* window.
- G. Restart the computer when asked.

For Windows 2000:

- A. Click **Start**, **Settings**, and **Control Panel**. Double-click **Network and Dial-Up Connections**.
- B. Right-click the **Local Area Connection** that is associated with the Ethernet adapter you are using, and select the **Properties** option.
- C. In the *Components checked are used by this connection* box, highlight **Internet Protocol (TCP/IP)**, and click the **Properties** button. Select **Use the following IP address** option.
- D. Enter a unique IP address that is not used by any other computer on the network connected to the Router. You can only use an IP address in the ranges 192.168.15.2 to 192.168.15.99 and 192.168.15.151 to 192.168.15.254.
- E. Enter the Subnet Mask, **255.255.255.0**.
- F. Enter the Default Gateway, **192.168.15.1** (Router's default IP address).
- G. Toward the bottom of the window, select **Use the following DNS server addresses**, and enter the Preferred DNS server and Alternative DNS server (provided by your ISP). Contact your ISP or go on its website to find the information.
- H. Click the **OK** button in the *Internet Protocol (TCP/IP) Properties* window, and click the **OK** button in the *Local Area Connection Properties* window.
- I. Restart the computer if asked.

For Windows XP:

The following instructions assume you are running Windows XP with the default interface. If you are using the Classic interface (where the icons and menus look like previous Windows versions), please follow the instructions for Windows 2000.

Broadband Router with 2 Phone Ports

- A. Click **Start** and **Control Panel**.
 - B. Click the **Network and Internet Connections** icon and then the **Network Connections** icon.
 - C. Right-click the **Local Area Connection** that is associated with the Ethernet adapter you are using, and select the **Properties** option.
 - D. In the *This connection uses the following items* box, highlight **Internet Protocol (TCP/IP)**. Click the **Properties** button.
 - E. Enter a unique IP address that is not used by any other computer on the network connected to the Router. You can only use an IP address in the ranges 192.168.15.2 to 192.168.15.99 and 192.168.15.151 to 192.168.15.254.
 - F. Enter the Subnet Mask, **255.255.255.0**.
 - G. Enter the Default Gateway, **192.168.15.1** (Router's default IP address).
 - H. Toward the bottom of the window, select **Use the following DNS server addresses**, and enter the Preferred DNS server and Alternative DNS server (provided by your ISP). Contact your ISP or go on its website to find the information.
 - I. Click the **OK** button in the *Internet Protocol (TCP/IP) Properties* window. Click the **OK** button in the *Local Area Connection Properties* window.
4. ***I want to test my Internet connection.***
- A. Check your TCP/IP settings.

For Windows 98 and Millennium:

Refer to Windows Help for details. Make sure **Obtain IP address automatically** is selected in the settings.

For Windows 2000:

1. Click **Start**, **Settings**, and **Control Panel**. Double-click **Network and Dial-Up Connections**.
2. Right-click the **Local Area Connection** that is associated with the Ethernet adapter you are using, and select the **Properties** option.

3. In the *Components checked are used by this connection* box, highlight **Internet Protocol (TCP/IP)**, and click the **Properties** button. Make sure that **Obtain an IP address automatically** and **Obtain DNS server address automatically** are selected.
4. Click the **OK** button in the *Internet Protocol (TCP/IP) Properties* window, and click the **OK** button in the *Local Area Connection Properties* window.
5. Restart the computer if asked.
6. Click the **OK** button in the *Internet Protocol (TCP/IP) Properties* window, and click the **OK** button in the *Local Area Connection Properties* window.
7. Restart the computer if asked.

For Windows XP:

The following instructions assume you are running Windows XP with the default interface. If you are using the Classic interface (where the icons and menus look like previous Windows versions), please follow the instructions for Windows 2000.

1. Click **Start** and **Control Panel**.
 2. Click the **Network and Internet Connections** icon and then the **Network Connections** icon.
 3. Right-click the **Local Area Connection** that is associated with the Ethernet adapter you are using, and select the **Properties** option.
 4. In the *This connection uses the following items* box, highlight **Internet Protocol (TCP/IP)**, and click the **Properties** button. Make sure that **Obtain an IP address automatically** and **Obtain DNS server address automatically** are selected.
- B. Open a command prompt.
- For Windows 98 and Millennium, click **Start** and **Run**. In the *Open* field, type **command**. Press the **Enter** key or click the **OK** button.

Broadband Router with 2 Phone Ports

- For Windows 2000 and XP, click **Start** and **Run**. In the *Open* field, type **cmd**. Press the **Enter** key or click the **OK** button.
- C. In the command prompt, type **ping 192.168.15.1** and press the **Enter** key.
- If you get a reply, the computer is communicating with the Router.
 - If you do NOT get a reply, check the cable, and make sure **Obtain an IP address automatically** is selected in the TCP/IP settings for your Ethernet adapter.
- D. In the command prompt, type **ping** followed by your Internet IP address and press the **Enter** key. The Internet IP Address can be found in the web interface of the Router. For example, if your Internet IP address is 1.2.3.4, you would enter **ping 1.2.3.4** and press the **Enter** key.
- If you get a reply, the computer is connected to the Router.
 - If you do NOT get a reply, try the ping command from a different computer to verify that your original computer is not the cause of the problem.
- E. In the command prompt, type **ping www.linksys.com** and press the **Enter** key.
- If you get a reply, the computer is connected to the Internet. If you cannot open a webpage, try the ping command from a different computer to verify that your original computer is not the cause of the problem.
 - If you do NOT get a reply, there may be a problem with the connection. Try the ping command from a different computer to verify that your original computer is not the cause of the problem.
5. ***I am not getting an IP address on the Internet with my Internet connection.***
- A. Refer to "Problem #4, I want to test my Internet connection" to verify that you have connectivity.
- B. If you need to register the MAC address of your Ethernet adapter with your ISP, please see "Appendix B: Finding the MAC Address and IP Address for Your Ethernet Adapter." If you need to clone the MAC address of your Ethernet adapter onto the Router, see the MAC Address Clone section of "Chapter 5: Configuring the Router" for details.

- C. Make sure you are using the right Internet settings. Contact your ISP to see if your Internet connection type is DHCP, Static IP Address, or PPPoE (commonly used by DSL consumers). Please refer to the Basic Setup section of "Chapter 5: Configuring the Router" for details on Internet Connection Type settings.
- D. Make sure you use the right cable. Check to see if the Internet LED is solidly lit.
- E. Make sure the cable connecting from your cable or DSL modem is connected to the Router's Internet port. Verify that the Status page of the Router's Web-based Utility shows a valid IP address from your ISP.
- F. Turn off the computer, Router, and cable/DSL modem. Wait 30 seconds, and then turn on the Router, cable/DSL modem, and computer. Check the Status tab of the Router's Web-based Utility to see if you get an IP address.

6. I am not able to access the Router's Web-based Utility Setup page.

- A. Refer to "Problem #4, I want to test my Internet connection" to verify that your computer is properly connected to the Router.
- B. Refer to "Appendix B: Finding the MAC Address and IP Address for Your Ethernet Adapter" to verify that your computer has an IP Address, Subnet Mask, Gateway, and DNS.
- C. Set a static IP address on your system; refer to "Problem #3: I need to set a static IP address on a PC."
- D. Refer to "Problem #12: I am a PPPoE user, and I need to remove the proxy settings or the dial-up pop-up window."

7. I can't get my Virtual Private Network (VPN) to work through the Router.

Access the Router's web interface by going to <http://192.168.15.1> or the IP address of the Router, and go to the **Security => VPN Passthrough** tab. Make sure you have IPsec passthrough and/or PPTP passthrough enabled.

VPNs that use IPsec with the ESP (Encapsulation Security Payload known as protocol 50) authentication will work fine. At least one IPsec session will work through the Router; however, simultaneous IPsec sessions may be possible, depending on the specifics of your VPNs.

VPNs that use IPSec and AH (Authentication Header known as protocol 51) are incompatible with the Router. AH has limitations due to occasional incompatibility with the NAT standard.

Change the IP address for the Router to another subnet to avoid a conflict between the VPN IP address and your local IP address. For example, if your VPN server assigns an IP address 192.168.15.X (X is a number from 1 to 254) and your local LAN IP address is 192.168.15.X (X is the same number used in the VPN IP address), the Router will have difficulties routing information to the right location. If you change the Router's IP address to 192.168.2.1, that should solve the problem. Change the Router's IP address through the Basic Setup tab of the Web-based Utility. If you assigned a static IP address to any computer or network device on the network, you need to change its IP address accordingly to 192.168.2.Y (Y being any number from 1 to 254). Note that each IP address must be unique within the network.

Your VPN may require port 500/UDP packets to be passed to the computer that is connecting to the IPSec server. Refer to "Problem #9, I need to set up online game hosting or use other Internet applications" for details. Check the Linksys website at www.linksys.com for more information.

8. I need to set up a server behind my Router.

To use a server like a web, ftp, or mail server, you need to know the respective port numbers they are using. For example, port 80 (HTTP) is used for web; port 21 (FTP) is used for FTP, and port 25 (SMTP outgoing) and port 110 (POP3 incoming) are used for the mail server. You can get more information by viewing the documentation provided with the server you installed. Follow these steps to set up port forwarding through the Router's Web-based Utility. We will be setting up web, ftp, and mail servers.

- A. Access the Router's Web-based Utility by going to <http://192.168.15.1> or the IP address of the Router. Go to the **Applications & Gaming => Port Range Forwarding** tab.
- B. Enter any name you want to use for the Application.

- C. Enter the port range of the service you are using. For example, if you have a web server, you would enter the range 80 to 80.
- D. Select the protocol you will be using, **TCP** or **UDP**, or select **Both**.
- E. Enter the IP address of the PC or network device that you want the port server to go to. For example, if the web server's Ethernet adapter IP address is 192.168.15.100, you would enter 100 in the field provided. Check "Appendix B: Finding the MAC Address and IP Address for Your Ethernet Adapter" for details on getting an IP address.
- F. Check the **Enabled** option for the port services you want to use. Consider the examples below:

Application	Start and End	Protocol	IP Address	Enabled
Web server	80 to 80	Both	192.168.15.100	X
FTP server	21 to 21	TCP	192.168.15.101	X
SMTP (outgoing)	25 to 25	Both	192.168.15.102	X
POP3 (incoming)	110 to 110	Both	192.168.15.102	X

When you have completed the configuration, click the **Save Settings** button.

9. I need to set up online game hosting or use other Internet applications.

If you want to play online games or use Internet applications, most will work without doing any port forwarding or DMZ hosting. There may be cases when you want to host an online game or Internet application. This would require you to set up the Router to deliver incoming packets or data to a specific computer. This also applies to the Internet applications you are using. The best way to get the information on what port services to use is to go to the website of the online game or application you want to use. Follow these steps to set up online game hosting or use a certain Internet application:

Broadband Router with 2 Phone Ports

- A. Access the Router's Web-based Utility by going to **http://192.168.15.1** or the IP address of the Router. Go to the **Applications & Gaming => Port Range Forwarding** tab.
- B. Enter any name you want to use for the Application.
- C. Enter the port range of the service you are using. For example, if you have a web server, you would enter the range 80 to 80.
- D. Select the protocol you will be using, **TCP** or **UDP**, or select **Both**.
- E. Enter the IP address of the PC or network device that you want the port server to go to. For example, if the web server's Ethernet adapter IP address is 192.168.15.100, you would enter 100 in the field provided. Check "Appendix B: Finding the MAC Address and IP Address for Your Ethernet Adapter" for details on getting an IP address.
- F. Check the **Enabled** option for the port services you want to use. Consider the examples below:

Application	Start and End	Protocol	IP Address	Enabled
UT	7777 to 27900	Both	192.168.15.100	X
Halflife	27015 to 27015	Both	192.168.15.105	X
PC Anywhere	5631 to 5631	UDP	192.168.15.102	X
VPN IPSEC	500 to 500	UDP	192.168.15.100	X

When you have completed the configuration, click the **Save Settings** button.

10. I can't get the Internet game, server, or application to work.

If you are having difficulties getting any Internet game, server, or application to function properly, consider exposing one PC to the Internet using DeMilitarized Zone (DMZ) hosting. This option is available when an

application requires too many ports or when you are not sure which port services to use. Make sure you disable all the forwarding entries if you want to successfully use DMZ hosting, since forwarding has priority over DMZ hosting. (In other words, data that enters the Router will be checked first by the forwarding settings. If the port number that the data enters from does not have port forwarding, then the Router will send the data to whichever PC or network device you set for DMZ hosting.) Follow these steps to set DMZ hosting:

- A. Access the Router's Web-based Utility by going to <http://192.168.15.1> or the IP address of the Router. Go to the **Applications & Gaming => Port Range Forwarding** tab.
- B. Disable or remove the entries you have entered for forwarding. Keep this information in case you want to use it at a later time.
- C. Click the **DMZ** tab.
- D. Enter the Ethernet adapter's IP address of the computer you want exposed to the Internet. This will bypass the NAT security for that computer. Please refer to "Appendix B: Finding the MAC Address and IP Address for Your Ethernet Adapter" for details on getting an IP address.

Once completed with the configuration, click the **Save Settings** button.

11. I forgot my password, or the password prompt always appears when saving settings to the Router.

Reset the Router to factory default by pressing the Reset button for 30 seconds and then releasing it. If you are still getting prompted for a password when saving settings, then perform the following steps:

- A. Access the Router's web interface by going to <http://192.168.15.1> or the IP address of the Router. Enter the default password admin, and click the **Administration => Management** tab.
- B. Enter a different password in the *Router Password* field, and enter the same password in the second field to confirm the password.
- C. Click the **Save Settings** button.

Broadband Router with 2 Phone Ports

12. I am a PPPoE user, and I need to remove the proxy settings or the dial-up pop-up window.

If you have proxy settings, you need to disable these on your computer. Because the Router is the gateway for the Internet connection, the computer does not need any proxy settings to gain access. Please follow these directions to verify that you do not have any proxy settings and that the browser you use is set to connect directly to the LAN.

For Microsoft Internet Explorer 5.0 or higher:

- A. Click **Start**, **Settings**, and **Control Panel**. Double-click **Internet Options**.
- B. Click the **Connections** tab.
- C. Click the **LAN settings** button and remove anything that is checked.
- D. Click the **OK** button to go back to the previous screen.
- E. Click the option **Never dial a connection**. This will remove any dial-up pop-ups for PPPoE users.

For Netscape 4.7 or higher:

- A. Start **Netscape Navigator**, and click **Edit**, **Preferences**, **Advanced**, and **Proxies**.
- B. Make sure you have **Direct connection to the Internet** selected on this screen.
- C. Close all the windows to finish.

13. To start over, I need to set the Router to factory default.

Hold the Reset button for approximately five seconds and then release it. This will return the password, forwarding, and other settings on the Router to the factory default settings. In other words, the Router will revert to its original factory configuration.

14. My DSL service's PPPoE is always disconnecting.

PPPoE is not actually a dedicated or always-on connection. The DSL ISP can disconnect the service after a period of inactivity, just like a normal phone dial-up connection to the Internet. There is a setup option to "keep alive" the connection. This may not always work, so you may need to re-establish connection periodically.

- A. To connect to the Router, go to the web browser, and enter **http://192.168.15.1** or the IP address of the Router.
- B. Enter the password, if asked. (The default password is **admin**.)
- C. On the *Basic Setup* tab, select the option **Keep Alive**, and set the *Redial Period* option at **20** (seconds).
- D. Click the **Save Settings** button.
- E. Click the **Status** tab, and click the **Connect** button.
- F. You may see the login status display as **Connecting**. Press the **F5** key to refresh the screen, until you see the login status display as **Connected**.

If the connection is lost again, follow steps E and F to re-establish connection.

15. I can't access my email, web, or VPN, or I am getting corrupted data from the Internet.

The Maximum Transmission Unit (MTU) setting may need to be adjusted. By default, the MTU is set at 1500. For most DSL users, it is strongly recommended to use MTU 1492. If you are having some difficulties, perform the following steps:

- A. To connect to the Router, go to the web browser, and enter **http://192.168.15.1** or the IP address of the Router.
- B. Enter the password, if asked. (The default password is **admin**.)
- C. On the *Basic Setup* tab, look for the MTU option, and select **Enable**. In the *Size* field, enter 1492.
- D. Click the **Save Settings** button to continue.

Broadband Router with 2 Phone Ports

If your difficulties continue, change the Size to different values. Try this list of values, one value at a time, in this order, until your problem is solved:

1462
1400
1362
1300

16. I need to use port triggering.

Port triggering looks at the outgoing port services used and will trigger the Router to open a specific port, depending on which port an Internet application uses. Follow these steps:

- A. To connect to the Router, go to the web browser, and enter **http://192.168.15.1** or the IP address of the Router.
- B. Enter the password, if asked. (The default password is **admin**.)
- C. Click the **Applications & Gaming => Port Triggering** tab.
- D. Enter any name you want to use for the Application Name.
- E. Enter the Start and End Ports of the Triggered Port Range. Check with your Internet application provider for more information on which outgoing port services it is using.
- F. Enter the Start and End Ports of the Forwarded Port Range. Check with your Internet application provider for more information on which incoming port services are required by the Internet application.

17. When I enter a URL or IP address, I get a time-out error or am prompted to retry.

Go through this checklist until your problem is solved:

- Check if other PCs work. If they do, ensure that your workstation's IP settings are correct (IP Address, Subnet Mask, Default Gateway, and DNS). Restart the computer that is having a problem.
- If the PCs are configured correctly, but still not working, check the Router. Ensure that it is connected and powered on. Connect to it and check its settings. (If you cannot connect to it, check the LAN and power connections.)

- If the Router is configured correctly, check your Internet connection (DSL/cable modem, etc.) to see if it is working correctly. You can remove the Router to verify a direct connection.
- Manually configure the TCP/IP with a DNS address provided by your ISP.
- Make sure that your browser is set to connect directly and that any dial-up is disabled. For Internet Explorer, click **Tools, Internet Options**, and then the **Connection** tab. Make sure that Internet Explorer is set to **Never dial a connection**. For Netscape Navigator, click **Edit, Preferences, Advanced**, and **Proxy**. Make sure that Netscape Navigator is set to **Direct connection to the Internet**.

Frequently Asked Questions

How do I make a phone call?

Pick up the phone and dial. Use 7-, 10-, or 11-digit dialing for calls within the same area code as your Internet phone number. Use 10- or 11-digit dialing for calls outside of your area code.

Can I make calls if my Internet connection is down?

No. Your high-speed Internet connection must be active when you make Internet phone or fax calls.

Can I make calls while I'm browsing the Internet?

Yes. You can make Internet phone or fax calls while browsing the Internet. However, your web browsing may affect the quality of your telephone call, depending on the amount of upstream data traffic passing through your Internet connection.

Can I receive calls while my network is down?

You cannot directly receive calls while your network is down. However, your Internet phone service provider can forward calls to a different telephone number, such as a cellular phone number, if you activate a feature called Network Availability Number. You can configure this feature through your service account.

Broadband Router with 2 Phone Ports

What is the maximum number of IP addresses that the Router will support?

The Router will support up to 253 IP addresses.

Where is the Router installed on the network?

In a typical environment, the Router is installed between the cable/DSL modem and the local area network (LAN). Plug the Router into the cable/DSL modem's Ethernet port.

Does the Router support IPX or AppleTalk?

No. TCP/IP is the only protocol standard for the Internet and has become the global standard for communications. IPX, a NetWare communications protocol used only to route messages from one node to another, and AppleTalk, a communications protocol used on Apple and Macintosh networks, can be used for LAN to LAN connections, but those protocols cannot connect from the Internet to the LAN.

What is Network Address Translation and what is it used for?

Network Address Translation (NAT) translates multiple IP addresses on the private LAN to one public address that is sent out to the Internet. This adds a level of security since the address of a PC connected to the private LAN is never transmitted on the Internet. Furthermore, NAT allows the Router to be used with low cost Internet accounts, such as DSL or cable modems, when only one TCP/IP address is provided by the ISP. The user may have many private addresses behind this single address provided by the ISP.

Does the Router support any operating system other than Windows 98, Millennium, 2000, or XP?

Yes, but Linksys does not, at this time, provide technical support for setup, configuration or troubleshooting of any non-Windows operating systems.

Does the Router support ICQ send file?

Yes, with the following fix: click **ICQ menu => preference => connections tab=>**, and check **I am behind a firewall or proxy**. Then set the firewall time-out to 80 seconds in the firewall setting. The Internet user can then send a file to a user behind the Router.

I set up an Unreal Tournament Server, but others on the LAN cannot join. What do I need to do?

If you have a dedicated Unreal Tournament server running, you need to create a static IP for each of the LAN computers and forward ports 7777, 7778, 7779, 7780, 7781, and 27900 to the IP address of the server. You can also use a port forwarding range of 7777 to 27900. If you want to use the UT Server Admin, forward another port (8080 usually works well but is used for remote admin. You may have to disable this.), and then in the [UWeb.WebServer] section of the server.ini file, set the ListenPort to 8080 (to match the mapped port above) and ServerName to the IP assigned to the Router from your ISP.

Can multiple gamers on the LAN get on one game server and play simultaneously with just one public IP address?

It depends on which network game or what kind of game server you are using. For example, Unreal Tournament supports multi-login with one public IP.

How do I get Half-Life: Team Fortress to work with the Router?

The default client port for Half-Life is 27005. The computers on your LAN need to have "+clientport 2700x" added to the HL shortcut command line; the x would be 6, 7, 8, and on up. This lets multiple computers connect to the same server. One problem: Version 1.0.1.6 won't let multiple computers with the same CD key connect at the same time, even if on the same LAN (not a problem with 1.0.1.3). As far as hosting games, the HL server does not need to be in the DMZ. Just forward port 27015 to the local IP address of the server computer.

How can I block corrupted FTP downloads?

If you are experiencing corrupted files when you download a file with your FTP client, try using another FTP program.

The web page hangs; downloads are corrupt, or nothing but junk characters are being displayed on the screen. What do I need to do?

Force your Ethernet adapter to 10Mbps or half duplex mode, and turn off the "Auto-negotiate" feature of your Ethernet adapter as a temporary measure. (Please look at the Network Control Panel in your Ethernet adapter's

Broadband Router with 2 Phone Ports

Advanced Properties tab.) Make sure that your proxy setting is disabled in the browser. Check our website at www.linksys.com for more information.

If all else fails in the installation, what can I do?

Reset the Router by holding down the Reset button for approximately five seconds. Reset your cable or DSL modem by powering the unit off and then on. Contact your Internet phone service provider for assistance. Refer to "Appendix H: Contact Information" for contact information.

Will the Router function in a Macintosh environment?

Yes, but the Router's setup pages are accessible only through Internet Explorer 5.0 or Netscape Navigator 5.0 or higher for Macintosh.

I am not able to get the web configuration screen for the Router. What can I do?

You may have to remove the proxy settings on your Internet browser, e.g., Netscape Navigator or Internet Explorer. Or remove the dial-up settings on your browser. Check with your browser documentation, and make sure that your browser is set to connect directly and that any dial-up is disabled. Make sure that your browser is set to connect directly and that any dial-up is disabled. For Internet Explorer, click **Tools, Internet Options**, and then the **Connection** tab. Make sure that Internet Explorer is set to **Never dial a connection**. For Netscape Navigator, click **Edit, Preferences, Advanced**, and **Proxy**. Make sure that Netscape Navigator is set to **Direct connection to the Internet**.

What is DMZ Hosting?

Demilitarized Zone (DMZ) allows one IP address (computer) to be exposed to the Internet. Some applications require multiple TCP/IP ports to be open. It is recommended that you set your computer with a static IP if you want to use DMZ Hosting. To get the LAN IP address, see "Appendix B: Finding the MAC Address and IP Address for Your Ethernet Adapter."

If DMZ Hosting is used, does the exposed user share the public IP with the Router?

No.

Is the Router cross-platform compatible?

Any platform that supports Ethernet and TCP/IP is compatible with the Router.

How many ports can be simultaneously forwarded?

Theoretically, the Router can establish 520 sessions at the same time, but you can only forward 10 ranges of ports.

Does the Router replace a modem? Is there a cable or DSL modem in the Router?

No, this version of the Router must work in conjunction with a cable or DSL modem.

Which modems are compatible with the Router?

The Router is compatible with virtually any cable or DSL modem that supports Ethernet.

How can I check whether I have static or DHCP IP addresses?

Ask your ISP to find out.

How do I get mIRC to work with the Router?

Under the Applications & Gaming => Port Range Forwarding tab, set port forwarding to **113** for the PC on which you are using mIRC.

What is a MAC Address?

The Media Access Control (MAC) address is a unique number assigned by the manufacturer to any Ethernet networking device, such as a network adapter, that allows the network to identify it at the hardware level. For all practical purposes, this number is usually permanent. Unlike IP addresses, which can change every time a

Broadband Router with 2 Phone Ports

computer logs onto the network, the MAC address of a device stays the same, making it a valuable identifier for the network.

How do I reset the Router?

Press the Reset button on the back panel for about five seconds. This will reset the Router to its default settings.

Appendix B: Finding the MAC Address and IP Address for Your Ethernet Adapter

This section describes how to find the MAC address for your computer's Ethernet adapter so you can use the MAC filtering and/or MAC address cloning feature of the Router. You can also find the IP address of your computer's Ethernet adapter. This IP address is used for the Router's filtering, forwarding, and/or DMZ features. Follow the steps in this appendix to find the adapter's MAC or IP address in Windows 98, Me, 2000, or XP.

Windows 98 or Me Instructions

1. Click **Start** and **Run**. In the *Open* field, enter `winipcfg`. Then press the **Enter** key or the **OK** button.
2. When the *IP Configuration* screen appears, select the Ethernet adapter you have connected to the Router via a CAT 5 Ethernet network cable.
3. Write down the Adapter Address as shown on your computer screen. This is the MAC address for your Ethernet adapter and is shown as a series of numbers and letters.

The MAC address/Adapter Address is what you will use for MAC address cloning or MAC filtering.

The example shows the Ethernet adapter's IP address as 192.168.1.100. Your computer may show something different.

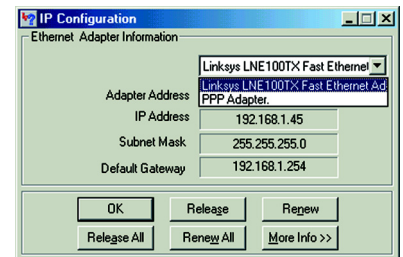

Figure B-1: IP Configuration Screen

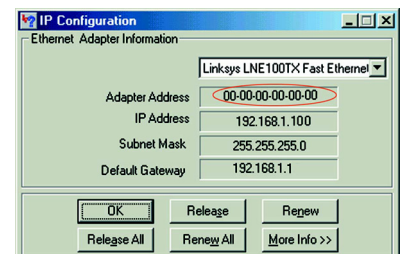

Figure B-2: MAC/Adapter Address

Windows 2000 or XP Instructions

1. Click **Start** and **Run**. In the *Open* field, enter `cmd`. Press the **Enter** key or click the **OK** button.
2. At the command prompt, enter `ipconfig /all`. Then press the **Enter** key.
3. Write down the Physical Address as shown on your computer screen; it is the MAC address for your Ethernet adapter. This appears as a series of numbers and letters.

The MAC address/Physical Address is what you will use for MAC address cloning or MAC filtering.

The example shows the Ethernet adapter's IP address as 192.168.1.100. Your computer may show something different.

For the Router's Web-based Utility

For MAC address cloning, enter the 12-digit MAC address in the fields provided, two digits per field.

For MAC filtering, enter the 12-digit MAC address in this format, XXXXXXXXXXXX, WITHOUT the hyphens.

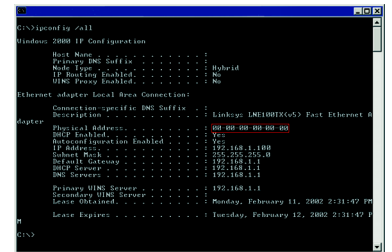

Figure B-3: MAC/Physical Address



Figure B-4: MAC Address Clone

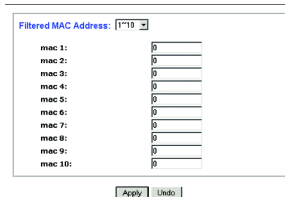

Figure B-5: MAC Address Filter

Appendix C: Windows Help

Almost all Linksys products require Microsoft Windows. Windows is the most used operating system in the world and comes with many features that help make networking easier. These features can be accessed through Windows Help and are described in this appendix.

TCP/IP

Before a computer can communicate with a network router, TCP/IP must be enabled. TCP/IP is a set of instructions, or protocol, all PCs follow to communicate over a network. This is true for wireless networks as well. Your PCs will not be able to utilize wireless networking without having TCP/IP enabled. Windows Help provides complete instructions on enabling TCP/IP.

Shared Resources

If you wish to share printers, folder, or files over your network, Windows Help provides complete instructions on utilizing shared resources.

Network Neighborhood/My Network Places

Other PCs on your network will appear under Network Neighborhood or My Network Places (depending upon the version of Windows you're running). Windows Help provides complete instructions on adding PCs to your network.

Broadband Router with 2 Phone Ports

Appendix D: Glossary

Adapter - A device that adds network functionality to your PC.

Backbone - The part of a network that connects most of the systems and networks together, and handles the most data.

Bandwidth - The transmission capacity of a given device or network.

Bit - A binary digit.

Boot - To start a device and cause it to start executing instructions.

Bridge - A device that connects different networks.

Broadband - An always-on, fast Internet connection.

Browser - An application program that provides a way to look at and interact with all the information on the World Wide Web.

Buffer - A shared or assigned memory area that is used to support and coordinate different computing and networking activities so one isn't held up by the other.

Byte - A unit of data that is usually eight bits long

Cable Modem - A device that connects a computer to the cable television network, which in turn connects to the Internet.

CSMA/CA (Carrier Sense Multiple Access/Collision Avoidance) - A method of data transfer that is used to prevent data collisions.

Daisy Chain - A method used to connect devices in a series, one after the other.

Database - A collection of data that is organized so that its contents can easily be accessed, managed, and updated.

Broadband Router with 2 Phone Ports

DDNS (Dynamic Domain Name System) - Allows the hosting of a website, FTP server, or e-mail server with a fixed domain name (e.g., www.xyz.com) and a dynamic IP address.

Default Gateway - A device that forwards Internet traffic from your local area network.

DHCP (Dynamic Host Configuration Protocol) - A networking protocol that allows administrators to assign temporary IP addresses to network computers by "leasing" an IP address to a user for a limited amount of time, instead of assigning permanent IP addresses.

DMZ (Demilitarized Zone) - Removes the Router's firewall protection from one PC, allowing it to be "seen" from the Internet.

DNS (Domain Name Server) - The IP address of your ISP's server, which translates the names of websites into IP addresses.

Domain - A specific name for a network of computers.

Download - To receive a file transmitted over a network.

DSL (Digital Subscriber Line) - An always-on broadband connection over traditional phone lines.

Dynamic IP Address - A temporary IP address assigned by a DHCP server.

Encryption - Encoding data transmitted in a network.

Ethernet - A networking protocol that specifies how data is placed on and retrieved from a common transmission medium.

Finger - A program that tells you the name associated with an e-mail address.

Firewall - A set of related programs located at a network gateway server that protects the resources of a network from users from other networks.

Firmware - The programming code that runs a networking device.

Fragmentation - Breaking a packet into smaller units when transmitting over a network medium that cannot support the original size of the packet.

FTP (File Transfer Protocol) - A protocol used to transfer files over a TCP/IP network.

Full Duplex - The ability of a networking device to receive and transmit data simultaneously.

Gateway - A device that interconnects networks with different, incompatible communications protocols.

Half Duplex - Data transmission that can occur in two directions over a single line, but only one direction at a time.

Hardware - The physical aspect of computers, telecommunications, and other information technology devices.

HTTP (HyperText Transport Protocol) - The communications protocol used to connect to servers on the World Wide Web.

IP (Internet Protocol) - A protocol used to send data over a network.

IP Address - The address used to identify a computer or device on a network.

IPCONFIG - A Windows 2000 and XP utility that displays the IP address for a particular networking device.

IPSec (Internet Protocol Security) - A VPN protocol used to implement secure exchange of packets at the IP layer.

ISM band - Radio bandwidth utilized in wireless transmissions.

ISP (Internet Service Provider) - A company that provides access to the Internet.

LAN - The computers and networking products that make up your local network.

MAC (Media Access Control) Address - The unique address that a manufacturer assigns to each networking device.

Mbps (MegaBits Per Second) - One million bits per second; a unit of measurement for data transmission.

mIRC - An Internet Relay Chat program that runs under Windows.

Multicasting - Sending data to a group of destinations at once.

Broadband Router with 2 Phone Ports

NAT (Network Address Translation) - NAT technology translates IP addresses of a local area network to a different IP address for the Internet.

Network - A series of computers or devices connected for the purpose of data sharing, storage, and/or transmission between users.

NNTP (Network News Transfer Protocol) - The protocol used to connect to Usenet groups on the Internet.

Node - A network junction or connection point, typically a computer or work station.

Packet - A unit of data sent over a network.

Ping (Packet INternet Groper) - An Internet utility used to determine whether a particular IP address is online.

POP3 (Post Office Protocol 3) - A standard mail server commonly used on the Internet.

Port - The connection point on a computer or networking device used for plugging in cables or adapters.

Power over Ethernet (PoE) - A technology enabling an Ethernet network cable to deliver both data and power.

PPPoE (Point to Point Protocol over Ethernet) - A type of broadband connection that provides authentication (username and password) in addition to data transport.

PPTP (Point-to-Point Tunneling Protocol) - A VPN protocol that allows the Point to Point Protocol (PPP) to be tunneled through an IP network. This protocol is also used as a type of broadband connection in Europe.

RJ-45 (Registered Jack-45) - An Ethernet connector that holds up to eight wires.

Router - A networking device that connects multiple networks together.

RTS (Request To Send) - A networking method of coordinating large packets through the RTS Threshold setting.

Server - Any computer whose function in a network is to provide user access to files, printing, communications, and other services.

SMTP (Simple Mail Transfer Protocol) - The standard e-mail protocol on the Internet.

SNMP (Simple Network Management Protocol) - A widely used network monitoring and control protocol.

Software - Instructions for the computer. A series of instructions that performs a particular task is called a "program".

SOHO (Small Office/Home Office) - Market segment of professionals who work at home or in small offices.

SPI (Stateful Packet Inspection) Firewall - A technology that inspects incoming packets of information before allowing them to enter the network.

Static IP Address - A fixed address assigned to a computer or device that is connected to a network.

Static Routing - Forwarding data in a network via a fixed path.

Subnet Mask - An address code that determines the size of the network.

Switch - 1. A data switch that connects computing devices to host computers, allowing a large number of devices to share a limited number of ports. 2. A device for making, breaking, or changing the connections in an electrical circuit.

TCP (Transmission Control Protocol) - A network protocol for transmitting data that requires acknowledgement from the recipient of data sent.

TCP/IP (Transmission Control Protocol/Internet Protocol) - A set of instructions PCs use to communicate over a network.

Telnet - A user command and TCP/IP protocol used for accessing remote PCs.

TFTP (Trivial File Transfer Protocol) - A version of the TCP/IP FTP protocol that has no directory or password capability.

Throughput - The amount of data moved successfully from one node to another in a given time period.

Topology - The physical layout of a network.

TX Rate - Transmission Rate.

Appendix D: Glossary

Broadband Router with 2 Phone Ports

UDP (User Datagram Protocol) - A network protocol for transmitting data that does not require acknowledgement from the recipient of the data that is sent.

Upgrade - To replace existing software or firmware with a newer version.

Upload - To transmit a file over a network.

URL (Uniform Resource Locator) - The address of a file located on the Internet.

VPN (Virtual Private Network) - A security measure to protect data as it leaves one network and goes to another over the Internet.

WAN (Wide Area Network)- The Internet.

WINIPCFG - A Windows 98 and Me utility that displays the IP address for a particular networking device.

Appendix E: Specifications

Model	RTP300	Ringer Equivalence Number (REN)	5 REN per RJ-11 Port
Standards	IEEE 802.3 (10BaseT), IEEE 802.3u (100BaseTX)	FXS Port Impedance	600 ohm resistive or 270 ohm + 750 ohm/150nF complex impedance
Ports/Button	One 10/100 RJ-45 Internet Port, Four 10/100 RJ-45 Network Ports, Two Standard Phone Ports, One Power Port, Rest Button	Ring Frequency	25 Hz
Cabling Type	RJ-45 Ethernet Category 5, RJ-11 Standard Phone Cable	Ring Voltage	40 - 50 Vrms
LEDs	INTERNET, PHONE1, PHONE2, ETHERNET (1-4), POWER	Dimensions (W x H x D)	6.69" x 6.69" x 1.22" (170 mm x 170 mm x 31 mm)
UPnP able/cert	Certified	Unit Weight	12.20 oz. (0.35 kg)
Network Protocols	TCP/IP	Power	External, 12V DC, 1.0A
Voice Protocol	Session Initiation Protocol (SIP v2)	Certifications	FCC, CE, cUL
Voice Codecs	G.711 a-law, G.711 μ -Law, G.726, G.729 A/B/E, and G.723.1	Operating Temp.	0° C to 40° C (32° F to 104° F)
		Storage Temp.	-20° C to 60° C (-4° F to 140° F)
		Operating Humidity	10% ~ 85% Non-Condensing

Broadband Router with 2 Phone Ports

Storage Humidity 5% ~ 90% Non-Condensing

Warranty 1-Year Limited

Appendix F: Warranty Information

LIMITED WARRANTY

Your Internet phone service provider warrants to You that, for a period of one year (the "Warranty Period"), your Linksys Product will be substantially free of defects in materials and workmanship under normal use. Your exclusive remedy and Your Internet phone service provider's entire liability under this warranty will be for Your Internet phone service provider at its option to repair or replace the Product or refund Your purchase price less any rebates. This limited warranty extends only to the original purchaser.

If the Product proves defective during the Warranty Period call Your Internet phone service provider Technical Support in order to obtain a Return Authorization Number, if applicable. If You are requested to return the Product, mark the Return Authorization Number clearly on the outside of the package. You are responsible for shipping defective Products to Your Internet phone service provider.

ALL IMPLIED WARRANTIES AND CONDITIONS OF MERCHANTABILITY OR FITNESS FOR A PARTICULAR PURPOSE ARE LIMITED TO THE DURATION OF THE WARRANTY PERIOD. ALL OTHER EXPRESS OR IMPLIED CONDITIONS, REPRESENTATIONS AND WARRANTIES, INCLUDING ANY IMPLIED WARRANTY OF NON-INFRINGEMENT, ARE DISCLAIMED. Some jurisdictions do not allow limitations on how long an implied warranty lasts, so the above limitation may not apply to You. This warranty gives You specific legal rights, and You may also have other rights which vary by jurisdiction.

This warranty does not apply if the Product (a) has been altered, except by Your Internet phone service provider, (b) has not been installed, operated, repaired, or maintained in accordance with instructions supplied by Your Internet phone service provider, or (c) has been subjected to abnormal physical or electrical stress, misuse, negligence, or accident. In addition, due to the continual development of new techniques for intruding upon and attacking networks, Your Internet phone service provider does not warrant that the Product will be free of vulnerability to intrusion or attack.

TO THE EXTENT NOT PROHIBITED BY LAW, IN NO EVENT WILL YOUR INTERNET PHONE SERVICE PROVIDER BE LIABLE FOR ANY LOST DATA, REVENUE OR PROFIT, OR FOR SPECIAL, INDIRECT, CONSEQUENTIAL, INCIDENTAL OR PUNITIVE DAMAGES, REGARDLESS OF THE THEORY OF LIABILITY (INCLUDING NEGLIGENCE), ARISING OUT OF OR RELATED TO THE USE OF OR INABILITY TO USE THE PRODUCT (INCLUDING ANY SOFTWARE), EVEN IF Your Internet phone service provider HAS BEEN ADVISED OF THE POSSIBILITY OF SUCH DAMAGES. IN NO EVENT WILL Your Internet phone service provider' LIABILITY EXCEED THE AMOUNT PAID BY YOU FOR THE PRODUCT. The foregoing limitations will apply even if any warranty or remedy provided under this Agreement fails of its essential purpose. Some jurisdictions do not allow the exclusion or limitation of incidental or consequential damages, so the above limitation or exclusion may not apply to You.

Please contact your Internet phone service provider regarding the warranty for the Product.

Broadband Router with 2 Phone Ports

Appendix G: Regulatory Information

FCC STATEMENT

This product has been tested and complies with the specifications for a Class B digital device, pursuant to Part 15 of the FCC Rules. These limits are designed to provide reasonable protection against harmful interference in a residential installation. This equipment generates, uses, and can radiate radio frequency energy and, if not installed and used according to the instructions, may cause harmful interference to radio communications. However, there is no guarantee that interference will not occur in a particular installation. If this equipment does cause harmful interference to radio or television reception, which is found by turning the equipment off and on, the user is encouraged to try to correct the interference by one or more of the following measures:

- Reorient or relocate the receiving antenna
- Increase the separation between the equipment or devices
- Connect the equipment to an outlet other than the receiver's
- Consult a dealer or an experienced radio/TV technician for assistance

SAFETY NOTICES

Caution: To reduce the risk of fire, use only No. 26 AWG or larger telecommunication line cord.

Do not use this product near water, for example, in a wet basement or near a swimming pool.

Avoid using this product during an electrical storm. There may be a remote risk of electric shock from lightning.

Broadband Router with 2 Phone Ports

INDUSTRY CANADA STATEMENT

This device complies with Canadian ICES-003 rule.

Cet appareil est conforme à la norme NMB-003 d'Industry Canada.

EC DECLARATION OF CONFORMITY (EUROPE)

In compliance with the EMC Directive 89/336/EEC, Low Voltage Directive 73/23/EEC, and Amendment Directive 93/68/EEC, this product meets the requirements of the following standards:

- EN55022 Emission
- EN55024 Immunity

Appendix H: Contact Information

Need to contact Linksys?

Visit us online for information on the latest products and updates to your existing products at:

<http://www.linksys.com> or
[ftp.linksys.com](ftp://ftp.linksys.com)

Can't find information about a product you want to buy on the web? Do you want to know more about networking with Linksys products? Give our advice line a call at:
Or fax your request in to:

800-546-5797 (LINKSYS)
949-823-3002

If you experience problems with any Linksys product, you can call us at:

800-326-7114
support@linksys.com

Don't wish to call? You can e-mail us at:

Broadband Router with 2 Phone Ports

www.linksys.com