



NETGEAR®

54 Mbps Wireless Ethernet Bridge WGE101

Installation Guide

Follow these quick steps to install your bridge.

Note: Before you begin, have your wireless network set up and working.

Unpack the box, verify the contents, and follow the instructions in this installation guide. For more details, see the *WGE101 Reference Manual* on the *WGE101 54 Mbps Wireless Ethernet Bridge Resource CD* or at www.netgear.com/docs/wge101.

Note: When you set up the bridge, place it away from potential sources of interference, such as computers, monitors, TVs, microwaves, cordless phones, or large metal surfaces.

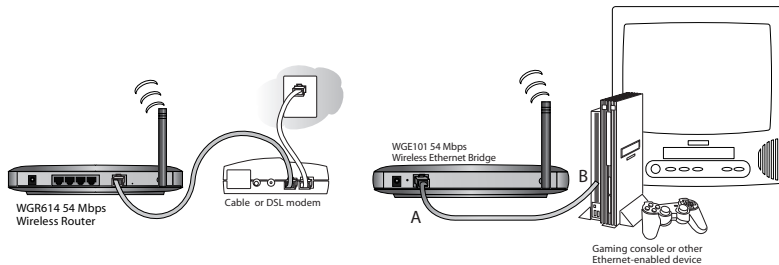





Internet Gaming Setup

What you need:

- WGE101 54 Mbps Wireless Ethernet Bridge.
- Broadband Internet access through a 802.11b or 802.11g wireless router with no security features enabled OR through a router with a 802.11b or 802.11g wireless access point with no security features enabled.
- Ethernet-enabled game console.

What you do:

1. Connect the provided Ethernet cable between the WGE101 Wireless Bridge (A) and the gaming console (B).
2. Connect the power adapter to the wireless bridge and plug the power adapter in to a power outlet. The Power  and Wireless  lights should light up.
3. After the Wireless light  lights up, turn on the gaming console. If the bridge and the gaming console are successfully connected, the Network light  will light up. This light flashes when there is network activity.

Note: If your setup works with the default settings, you don't need to configure the bridge *unless* you have to change the Country/Region setting (from the default value of United States) or the bridge's default IP address (because the network has another WGE101 bridge on it).

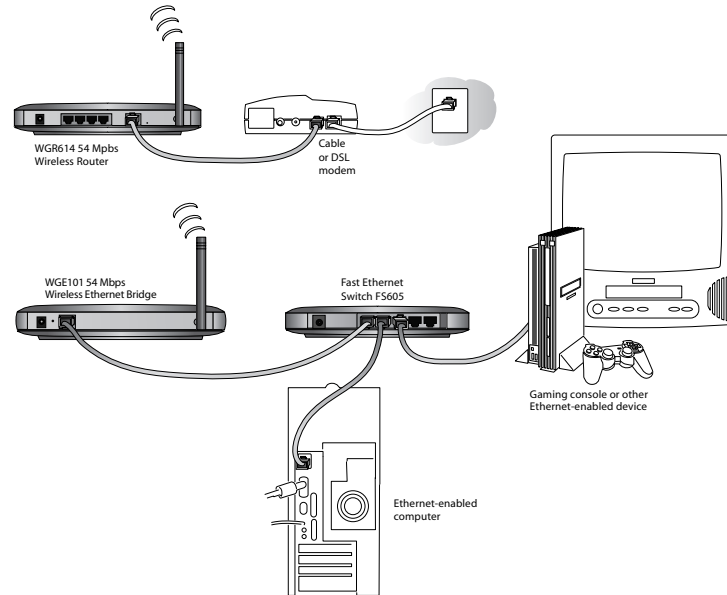

Share the Wireless Bridge Setup



What you need:

- WGE101 54 Mbps Wireless Ethernet Bridge.
- A switch or hub (such as the NETGEAR FS605, FS608, or EN104TP).
- Broadband Internet access through a 802.11b or 802.11g wireless router with no security features enabled OR through a router with a 802.11b or 802.11g wireless access point with no security features enabled.
- Game consoles, computers, printers, or other Ethernet-enabled devices that you want to connect to your network.

What you do:

1. Shut down or power down the Ethernet-enabled devices that you want to connect through the bridge.
2. Connect the provided Ethernet cable between the bridge and the switch (or hub).
3. Connect an Ethernet cable between the switch (or hub) and each computer or printer that you want to be able to communicate through the bridge.
4. Plug the power adapters into the bridge and the switch (or hub) and then plug the power adapters into a power source. The Power  and Wireless  lights should light up.
5. After the Wireless light  lights up, power up any game console(s) first. Then power up the other Ethernet-enabled devices.

If the bridge and the Ethernet-enabled devices are successfully connected, the Network light  will light up. This light flashes when there is network activity.

Note: If your setup works with the default settings, you don't need to configure the bridge *unless* you have to change the Country/Region setting (from the default value of United States) or the bridge's default IP address (because the network has another WGE101 bridge on it).

Configuring the Bridge

You configure the bridge to change the Country/Region setting, to change the bridge's IP address, to enable the security settings, or to change other settings. To configure the bridge you must have it connected to a personal computer — either directly or through a switch or hub.

If you have a Windows® computer, you can configure the bridge's basic connection settings using the NETGEAR Smart Navigator.

(With a Macintosh®, Linux®, or UNIX® computer, you use browser-based configuration software to change the bridge's settings. See the *WGE101 Reference Manual* on the *WGE101 54 Mbps Wireless Ethernet Bridge Resource CD* for details.)

To use the NETGEAR Smart Navigator:



1. Connect the bridge to a Windows computer.
2. Insert the *WGE101 54 Mbps Wireless Ethernet Bridge Resource CD* into the CD-ROM drive and follow the instructions to install the NETGEAR Smart Navigator.
3. Choose **Programs>NETGEAR WGE101 Bridge>Smart Navigator** from the **Start** menu.
4. Select the bridge in the device list.
5. Click **Connection Settings**.
6. To change the Country/Region, select a different country or region.

Note: Having the wrong Country/Region setting may violate local laws.
7. Make any other needed connection settings changes.
8. To apply these changes, click **OK**, type **admin** as the User name and **password** as the Password, click **OK**.
9. If the warning about selecting the incorrect region, appears, click **Yes**.

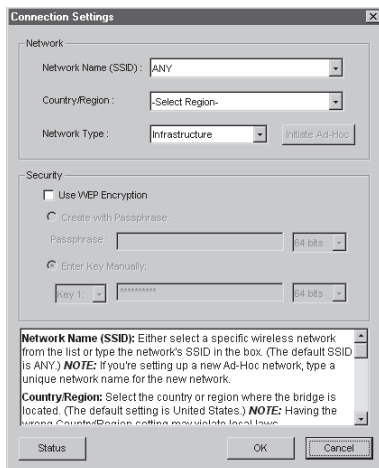
To make other changes (like changing the IP address or changing the password), click the **Advanced Settings** button on the Smart Navigator window. If you get a warning about the IP address not matching the network IP address, see the *Smart Navigator Reference Manual* on the CD. See the *WGE101 Reference Manual* on the CD for details about working with the browser-based configuration software.



WGE101 802.11g Wireless Ethernet Bridge Lights

	PWR	Green	OFF: No power to the unit. ON: Power applied to the unit.
	WLAN	Green	OFF: No wireless LAN activity. Flashing: Searching for an access point or wireless router. ON: Communicating to a wireless LAN.
	LAN	Green	OFF: No Ethernet traffic. Flashing: Wired Ethernet traffic. ON: Connected to the Ethernet.

Reset to Factory Defaults

Press the **Default** button (located between the Ethernet port and the AC adapter socket) for at least 6 seconds and then release the button. When the lights stop flashing the bridge has been reset.

Quick Troubleshooting Tips

If you have trouble setting up your WGE101, check these tips. The troubleshooting section in the *WGE101 Reference Manual* on the *WGE101 54 Mbps Wireless Ethernet Bridge Resource CD* has more details and additional tips.

The Wireless light is always blinking.

The bridge has not connected to a wireless network.

- Make sure the WGE101 is within range of the wireless network
- Make sure that the Network Name (SSID), WEP, and Country/Region settings match those of the router or access point.

The Wireless light is on, but I cannot connect to the Internet.

There is a network configuration problem.

- Make sure the wireless network security (WEP) settings and the bridge's security (WEP) settings match.
- Make sure the IP addresses for the computer, bridge, and router all start with the same numbers (for example, 192.168.0.yyy). Also, the subnet masks should match (for example, 255.255.255.0).
- If a gaming console connected through a switch or hub cannot connect to the Internet, with power on disconnect everything from the switch or hub. Re-connect the bridge, then the game console(s). Finally, connect any other device(s).

My bridge-enabled computer cannot communicate with my wireless-enabled computer or printer.

There is a network configuration problem.

- Check that the wireless-enabled computer or printer is on the same wireless network as the computer using the bridge.
- Make sure the WEP key (if WEP is enabled) and Country/Region selection are the same for all devices using the same wireless network.

I cannot configure the WGE101 using a browser.

You did not specify the correct IP address for the bridge.

- Type the bridge's IP address . The default address is 192.168.0.201.
- Make sure the IP addresses for your computer and the bridge have the same IP subset address. The IP addresses for both devices should start with the same numbers (for example, 192.168.0.yyy). Also, the subnet masks should match (for example, 255.255.255.0).

Technical Support

PLEASE REFER TO THE SUPPORT INFORMATION CARD THAT SHIPPED WITH YOUR PRODUCT.

By registering your product at www.NETGEAR.com/register, we can provide you with faster expert technical support and timely notices of product and software upgrades.

NETGEAR, INC.

Support Information

Phone: 1-888-NETGEAR (for US & Canada only) — 24x7 phone support

For other countries see your Support information card.

E-mail: Support@NETGEAR.com (24x7 online support)

Web site: www.NETGEAR.com

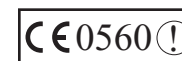

Attention: When you configure the wireless settings of this device please make sure to select the correct country settings. Due to EU-law, the country settings must be identical to the country where the device is operating (important due to non-harmonized frequencies in the EU).

©2003 by NETGEAR, Inc. NETGEAR, the Netgear logo, Everybody's Connecting, Auto Uplink and The Gear Guy are trademarks or registered trademarks of Netgear, Inc. in the United States and/or other countries. Microsoft and Windows are trademarks or registered trademarks of Microsoft Corporation in the United States and/or other countries. Other brand or product names are trademarks or registered trademarks of their respective owners. Information is subject to change without notice. All rights reserved.



M-10131-02

July 2003