



NBG6515

AC750 Dual-Band Wireless Gigabit Router

Version 1.00
Edition 1, 01/2016



User's Guide

Default Details

Default Details	
LAN IP Address	
- Router Mode (Default mode)	http://192.168.1.1
- AP/Repeater Mode	http://192.168.1.2
User Name	admin
Password	1234
2.4G SSID	ZyXEL + Last 6 digits of the 2.4G MAC address (ZyXEL734916)
5G SSID	ZyXEL+ Last 6 digits of the 5G MAC address + .speed (ZyXEL734917.speed)
Pre-shared Key	Serial number + Random key

IMPORTANT!

READ CAREFULLY BEFORE USE.

KEEP THIS GUIDE FOR FUTURE REFERENCE.

Screenshots and graphics in this book may differ slightly from your product due to differences in your product firmware or your computer operating system. Every effort has been made to ensure that the information in this manual is accurate.

Related Documentation

- Quick Start Guide

The Quick Start Guide shows how to connect the NBG and access the Web Configurator.

Note: It is recommended you use the Web Configurator to configure the NBG.

- More Information

Go to support.zyxel.com to find other information on the NBG.



Contents Overview

User's Guide	11
Getting to Know Your NBG	12
Connection Wizard	17
Introducing the Web Configurator	26
Monitor	31
NBG Modes	36
Easy Mode	37
Router Mode	49
Access Point Mode	56
Universal Repeater Mode	63
Tutorials	72
Technical Reference	79
Wireless LAN	80
IPv6	96
WAN	101
LAN	111
DHCP Server	114
Network Address Translation (NAT)	117
Dynamic DNS	123
Static Route	125
Firewall	127
Content Filter	134
Bandwidth Management	136
Remote Management	142
Universal Plug-and-Play (UPnP)	144
USB Media Sharing	151
Maintenance	160
Troubleshooting	167

Table of Contents

Contents Overview	3
Table of Contents	4
Part I: User's Guide	11
Chapter 1	
Getting to Know Your NBG	12
1.1 Overview	12
1.2 Applications	12
1.3 Ways to Manage the NBG	12
1.4 Good Habits for Managing the NBG	13
1.5 LEDs	14
1.6 The WPS Button	15
1.7 Wall Mounting	15
Chapter 2	
Connection Wizard	17
2.1 Overview	17
2.2 Accessing the Wizard	17
2.3 Connect to Internet	17
2.3.1 Connection Type: DHCP	18
2.3.2 Connection Type: Static IP	19
2.3.3 Connection Type: PPPoE	20
2.3.4 Connection Type: PPTP	21
2.4 Router Password	22
2.5 Wireless Security	23
2.5.1 Wireless Security: No Security	23
2.5.2 Wireless Security: WPA-PSK/WPA2-PSK	24
Chapter 3	
Introducing the Web Configurator	26
3.1 Overview	26
3.2 Accessing the Web Configurator	26
3.2.1 Login Screen	26
3.2.2 Password Screen	27
3.2.3 Home Screen	28
3.3 Resetting the NBG	30

3.3.1 Procedure to Use the Reset Button	30
Chapter 4	
Monitor.....	31
4.1 Overview	31
4.2 What You Can Do	31
4.3 The Log Screen	31
4.3.1 View Log	31
4.4 DHCP Table	32
4.5 Packet Statistics	33
4.6 WLAN 2.4G Station Status	34
4.7 WLAN 5G Station Status	35
Chapter 5	
NBG Modes	36
5.1 Overview	36
5.1.1 Web Configurator Modes	36
5.1.2 Device Modes	36
Chapter 6	
Easy Mode.....	37
6.1 Overview	37
6.2 What You Can Do	39
6.3 What You Need to Know	39
6.4 Navigation Panel	39
6.5 Network Map	39
6.6 Control Panel	40
6.6.1 Game Engine	41
6.6.2 Power Saving	42
6.6.3 Content Filter	43
6.6.4 Bandwidth Management	44
6.6.5 Firewall	44
6.6.6 Wireless Security	45
6.6.7 WPS	46
6.7 Status Screen in Easy Mode	47
Chapter 7	
Router Mode.....	49
7.1 Overview	49
7.2 What You Can Do	49
7.3 Status Screen	49
7.3.1 Navigation Panel	52

Chapter 8	
Access Point Mode.....	56
8.1 Overview	56
8.2 What You Can Do	56
8.3 What You Need to Know	56
8.3.1 Setting your NBG to AP Mode	57
8.3.2 Accessing the Web Configurator in Access Point Mode	57
8.3.3 Configuring your WLAN, Bandwidth Management and Maintenance Settings	57
8.4 AP Mode Status Screen	57
8.5 LAN Screen	60
Chapter 9	
Universal Repeater Mode.....	63
9.1 Overview	63
9.2 What You Can Do	63
9.3 What You Need to Know	63
9.4 Setting your NBG to Universal Repeater Mode	64
9.5 Universal Repeater Mode Status Screen	64
9.5.1 Navigation Panel	67
9.6 AP Select Screen	67
9.6.1 Wireless LAN 2.4G	67
9.6.2 Wireless LAN 5G	69
Chapter 10	
Tutorials.....	72
10.1 Overview	72
10.2 Connecting to the Internet from an Access Point	72
10.3 Configuring Wireless Security Using WPS	72
10.3.1 Push Button Configuration (PBC)	73
10.3.2 PIN Configuration	74
10.4 Enabling and Configuring Wireless Security (No WPS)	75
10.4.1 Configure Your Notebook	77
Part II: Technical Reference.....	79
Chapter 11	
Wireless LAN.....	80
11.1 Overview	80
11.2 What You Can Do	80
11.3 What You Should Know	81
11.3.1 Wireless Security Overview	81

11.4 General Wireless LAN 2.4G/5G General Screen	83
11.5 General Wireless LAN 2.4G/5G Security Screen	85
11.5.1 No Security	85
11.5.2 WEP Encryption	86
11.5.3 WPA-PSK/WPA2-PSK	88
11.6 MAC Filter	89
11.7 Wireless LAN Advanced Screen	90
11.8 Quality of Service (QoS) Screen	91
11.9 WPS Screen	91
11.10 WPS Device Screen	92
11.11 Scheduling Screen	93
11.12 Guest WLAN Screen	94
Chapter 12	
IPv6	96
12.1 IPv6 Overview	96
12.1.1 What You Can Do in this Chapter	96
12.1.2 What You Need to Know	96
12.2 General Screen	98
Chapter 13	
WAN	101
13.1 Overview	101
13.2 What You Can Do	101
13.3 What You Need To Know	101
13.3.1 Configuring Your Internet Connection	102
13.3.2 Multicast	103
13.4 Internet Connection	103
13.4.1 Ethernet Encapsulation	103
13.4.2 PPPoE Encapsulation	105
13.4.3 PPTP Encapsulation	107
13.5 Advanced WAN Screen	109
Chapter 14	
LAN	111
14.1 Overview	111
14.2 What You Can Do	111
14.3 What You Need To Know	111
14.3.1 IP Pool Setup	112
14.3.2 LAN TCP/IP	112
14.3.3 IP Alias	112
14.4 LAN IP Screen	112

Chapter 15	
DHCP Server	114
15.1 Overview	114
15.2 What You Can Do	114
15.3 General Screen	114
15.4 Advanced Screen	115
Chapter 16	
Network Address Translation (NAT).....	117
16.1 Overview	117
16.2 What You Can Do	117
16.3 General NAT Screen	118
16.4 NAT Application Screen	118
16.5 NAT Advanced Screen	120
16.5.1 Trigger Port Forwarding Example	121
16.5.2 Two Points To Remember About Trigger Ports	122
Chapter 17	
Dynamic DNS	123
17.1 Overview	123
17.2 What You Can Do	123
17.3 What You Need To Know	123
17.4 Dynamic DNS Screen	123
Chapter 18	
Static Route	125
18.1 Overview	125
18.2 What You Can Do	125
18.3 IP Static Route Screen	125
Chapter 19	
Firewall	127
19.1 Overview	127
19.2 What You Can Do	127
19.3 What You Need To Know	128
19.4 General Firewall Screen	128
19.5 MAC Filtering Rule Screen	129
19.6 IP Filtering Rule Screen	130
Chapter 20	
Content Filter	134
20.1 Overview	134
20.2 What You Can Do	134

20.3 What You Need To Know	134
20.3.1 Content Filtering Profiles	134
20.4 Content Filter Screen	135
Chapter 21	
Bandwidth Management.....	136
21.1 Overview	136
21.2 What You Can Do	136
21.3 What You Need To Know	137
21.4 General Screen	137
21.5 Advanced Screen	137
21.5.1 Rule Configuration: Application Rule Configuration	139
21.5.2 Rule Configuration: User Defined Service Rule Configuration	140
Chapter 22	
Remote Management.....	142
22.1 Overview	142
22.2 What You Can Do	142
22.3 What You Need to Know	142
22.3.1 Remote Management and NAT	142
22.3.2 System Timeout	143
22.4 WWW Screen	143
Chapter 23	
Universal Plug-and-Play (UPnP).....	144
23.1 Overview	144
23.2 What You Can Do	144
23.3 What You Need to Know	144
23.3.1 NAT Traversal	144
23.3.2 Cautions with UPnP	145
23.4 UPnP Screen	145
23.5 Technical Reference	145
23.5.1 Using UPnP in Windows XP Example	146
23.5.2 Web Configurator Easy Access	148
Chapter 24	
USB Media Sharing.....	151
24.1 Overview	151
24.2 What You Can Do	152
24.3 What You Need To Know	152
24.4 Before You Begin	153
24.5 SMB/CIFS Screen	154
24.6 DLNA Screen	155

24.7 FTP Screen	155
24.8 Example of Accessing Your Shared Files From a Computer	156
24.8.1 Use Windows Explorer to Share Files	157
24.8.2 Use FTP to Share Files	158
Chapter 25	
Maintenance	160
25.1 Overview	160
25.2 What You Can Do	160
25.3 General Screen	160
25.4 Password Screen	161
25.5 Time Setting Screen	162
25.6 Firmware Upgrade Screen	163
25.7 Configuration Backup/Restore Screen	164
25.8 Restart Screen	166
Chapter 26	
Troubleshooting.....	167
26.1 Power, Hardware Connections, and LEDs	167
26.2 NBG Access and Login	168
26.3 Internet Access	169
26.4 Resetting the NBG to Its Factory Defaults	171
26.5 Wireless Router/AP Troubleshooting	171
26.6 USB Device Problems	172
Appendix A IP Addresses and Subnetting.....	174
Appendix B Setting Up Your Computer's IP Address	184
Appendix C Wireless LANs.....	212
Appendix D Common Services.....	225
Appendix E Legal Information.....	229
Appendix F Customer Support	239
Index	245

PART I

User's Guide

Getting to Know Your NBG

1.1 Overview

This chapter introduces the main features and applications of the NBG.

The NBG upgrades the speed of your existing wireless network, providing faster network access to mobile users. Making use of IEEE 802.11AC technology, it not only upgrades your network to the next level but also eliminates dead spots, while offering backward compatibility with other IEEE 802.11b/g/n compatible devices.

A range of services such as a firewall and content filtering are also available for secure Internet computing. You can use media bandwidth management to efficiently manage traffic on your network. Bandwidth management features allow you to prioritize time-sensitive or highly important applications such as Voice over the Internet (VoIP).

1.2 Applications

You can create the following networks using the NBG:

- **Wired.** You can connect network devices via the Ethernet ports of the NBG so that they can communicate with each other and access the Internet.
- **Wireless.** Wireless clients can connect to the NBG to access network resources.
- **WAN.** Connect to a broadband modem/router for Internet access.

1.3 Ways to Manage the NBG

Use any of the following methods to manage the NBG.

- **Web Configurator.** This is recommended for everyday management of the NBG using a (supported) web browser.
- **Wireless switch.** You can use the built-in switch of the NBG to turn the wireless function on and off without opening the Web Configurator.
- **WPS (Wi-Fi Protected Setup) button.** You can use the WPS button or the WPS section of the Web Configurator to set up a wireless network with your NBG.

1.4 Good Habits for Managing the NBG

Do the following things regularly to make the NBG more secure and to manage the NBG more effectively.

- Change the password. Use a password that's not easy to guess and that consists of different types of characters, such as numbers and letters.
- Write down the password and put it in a safe place.
- Back up the configuration (and make sure you know how to restore it). Restoring an earlier working configuration may be useful if the device becomes unstable or even crashes. If you forget your password, you will have to reset the NBG to its factory default settings. If you backed up an earlier configuration file, you would not have to totally re-configure the NBG. You could simply restore your last configuration.

1.5 LEDs

Figure 1 Front Panel

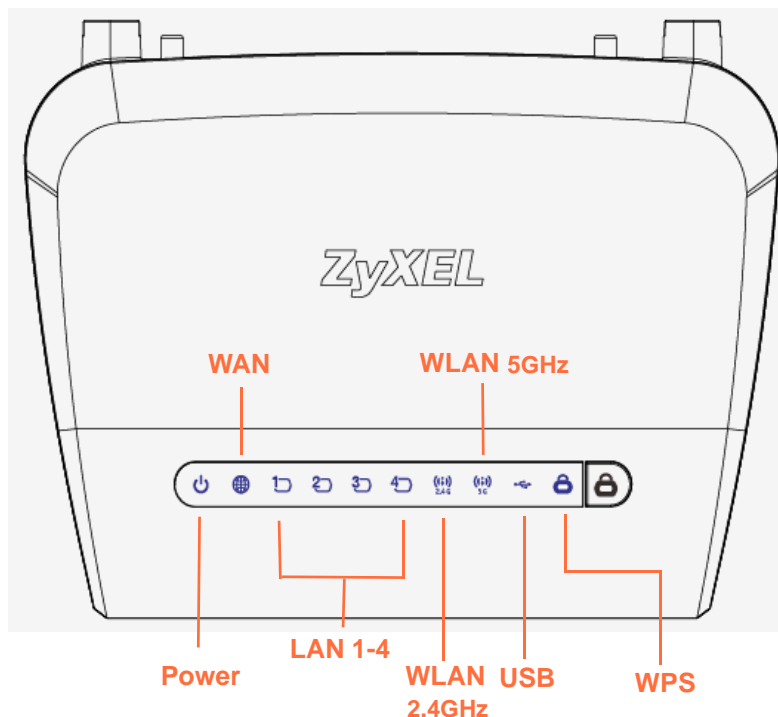

The following table describes the LEDs and the WPS button.

Table 1 Front Panel LEDs and WPS Button

LED	COLOR	STATUS	DESCRIPTION
POWER	Green	On	The NBG is receiving power and functioning properly.
		Off	The NBG is not receiving power.
WAN	Green	On	The NBG has a successful 10/100/1000MB WAN connection.
		Blinking	The NBG is sending/receiving data through the WAN.
		Off	The WAN connection is not ready, or has failed.
LAN 1-4	Green	On	The NBG has a successful 10/100/1000MB Ethernet connection.
		Blinking	The NBG is sending/receiving data through the LAN.
		Off	The LAN is not connected.
WLAN 2.4 GHz	Green	On	The NBG is ready, but is not sending/receiving data through the wireless LAN 2.4 GHz band.
		Blinking	The NBG is sending/receiving data through the wireless LAN 2.4 GHz band.
		Off	The wireless LAN 2.4 GHz band is not ready or has failed.

Table 1 Front Panel LEDs and WPS Button (continued)

LED	COLOR	STATUS	DESCRIPTION
WLAN 5 GHz	Green	On	The NBG is ready, but is not sending/receiving data through the wireless LAN 5 GHz band.
		Blinking	The NBG is sending/receiving data through the wireless LAN 5 GHz band.
		Off	The wireless LAN 5 GHz band is not ready or has failed.
USB	Green	On	The NBG has a USB device installed.
		Blinking	The NBG is transmitting and/or receiving data from routers through an installed USB device.
		Off	There is no USB device connected to the NBG.
WPS	Green	On	WPS is enabled.
		Blinking	The NBG is negotiating a WPS connection with a wireless client.
		Off	The wireless LAN is not ready or has failed.

1.6 The WPS Button

Your NBG supports WiFi Protected Setup (WPS), which is an easy way to set up a secure wireless network. WPS is an industry standard specification, defined by the WiFi Alliance.

WPS allows you to quickly set up a wireless network with strong security, without having to configure security settings manually. Each WPS connection works between two devices. Both devices must support WPS (check each device's documentation to make sure).

Depending on the devices you have, you can either press a button (on the device itself, or in its configuration utility) or enter a PIN (a unique Personal Identification Number that allows one device to authenticate the other) in each of the two devices. When WPS is activated on a device, it has two minutes to find another device that also has WPS activated. Then, the two devices connect and set up a secure network by themselves.

For more information on using WPS, see [Section 10.3 on page 72](#).

1.7 Wall Mounting

You may need screw anchors if mounting on a concrete or brick wall.

Table 2 Wall Mounting Information

Distance between holes	11 cm
M4 Screws	Two
Screw anchors (optional)	Two

- 1 Select a position free of obstructions on a wall strong enough to hold the weight of the device.
- 2 Mark two holes on the wall at the appropriate distance apart for the screws.

Be careful to avoid damaging pipes or cables located inside the wall when drilling holes for the screws.

- 3 If using screw anchors, drill two holes for the screw anchors into the wall. Push the anchors into the full depth of the holes, then insert the screws into the anchors. Do not insert the screws all the way in - leave a small gap of about 0.5 cm.

If not using screw anchors, use a screwdriver to insert the screws into the wall. Do not insert the screws all the way in - leave a gap of about 0.5 cm.

- 4 Make sure the screws are fastened well enough to hold the weight of the NBG with the connection cables.
- 5 Align the holes on the back of the NBG with the screws on the wall. Hang the NBG on the screws.

Figure 2 Wall Mounting Example

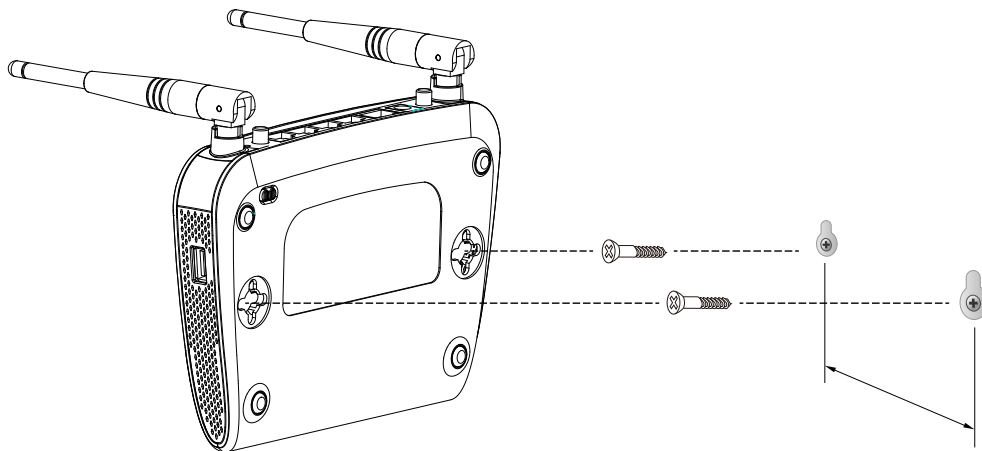

Connection Wizard

2.1 Overview

This chapter provides information on the wizard setup screens in the Web Configurator.

The Web Configurator's wizard setup helps you configure your device to access the Internet. Refer to your ISP for your Internet account information. Leave a field blank if you don't have that information.

2.2 Accessing the Wizard

Launch your web browser and type "http://192.168.1.1" as the website address. Type "1234" (default) as the password and click **Login**.

Note: The Wizard appears when the NBG is accessed for the first time or when you reset the NBG to its default factory settings.

The Wizard screen opens. Choose your **Language** and click **Connect to Internet**.

Figure 3 Welcome

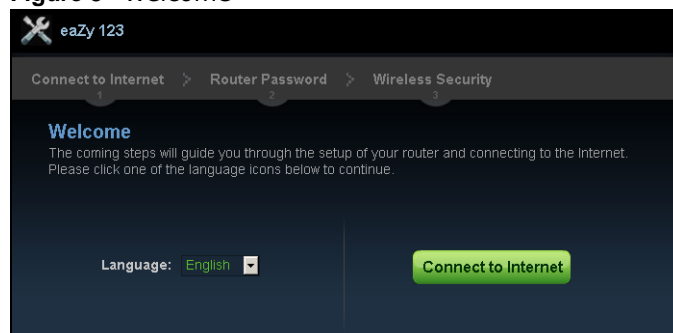

2.3 Connect to Internet

The NBG offers four Internet connection types. They are **Static IP**, **DHCP**, **PPPoE**, or **PPTP** (supported in the next firmware version). The wizard attempts to detect which WAN connection type you are using.

Figure 4 Detecting your Internet Connection Type

If the wizard does not detect a connection type, you must select one from the drop-down list box. Check with your ISP to make sure you use the correct type.

Note: If you get an error message, check your hardware connections. Make sure your Internet connection is up and running.

The following screen depends on your Internet connection type. Enter the details provided by your Internet Service Provider (ISP) in the fields (if any).

Figure 5 Internet Connection Type

Your NBG detects the following Internet Connection type.

Table 3 Internet Connection Type

CONNECTION TYPE	DESCRIPTION
Static IP	Select the Static IP if an administrator assigns the IP address of your computer.
DHCP	Select the DHCP (Dynamic Host Configuration Protocol) option when the WAN port is used as a regular Ethernet.
PPPoE	Select the PPPoE (Point-to-Point Protocol over Ethernet) option for a dial-up connection.
PPTP	Select the PPTP (Point-to-Point Tunneling Protocol) option for a dial-up connection, and your ISP gave you an IP address and/or subnet mask. Note: PPTP will be supported in the next firmware version.

2.3.1 Connection Type: DHCP

Choose **DHCP** as the **Internet Connection Type** when the WAN port is used as a regular Ethernet. Click **Next**.

Figure 6 Internet Connection Type: DHCP

Note: If you get an error screen after clicking **Next**, you might have selected the wrong Internet Connection type. Click **Back**, make sure your Internet connection is working and select the right Connection Type. Contact your ISP if you are not sure of your Internet Connection type.

2.3.2 Connection Type: Static IP

Choose **Static IP** as the **Internet Connection Type** if your ISP assigned an IP address for your Internet connection. Click **Next**.

Figure 7 Internet Connection Type: Static IP

The following table describes the labels in this screen.

Table 4 Internet Connection Type: Static IP

LABEL	DESCRIPTION
Internet Connection Type	Select the Static IP option.
IP Address	Enter the IP address provided by your ISP.
Subnet Mask	Enter the IP subnet mask in this field.
Default Gateway	Enter the gateway IP address in this field.

Table 4 Internet Connection Type: Static IP (continued)

LABEL	DESCRIPTION
Primary DNS	DNS (Domain Name System) is for mapping a domain name to its corresponding IP address and vice versa. The DNS server is extremely important because without it, you must know the IP address of a computer before you can access it. The NBG uses a system DNS server (in the order you specify here) to resolve domain names for DDNS and the time server. Enter the primary DNS server's IP address in the fields provided.
Secondary DNS	Enter the secondary DNS server's IP address in the fields provided.
Exit	Click this to close the wizard screen without saving.
Back	Click this to return to the previous screen.
Next	Click this to continue.

2.3.3 Connection Type: PPPoE

Point-to-Point Protocol over Ethernet (PPPoE) functions as a dial-up connection. PPPoE is an IETF (Internet Engineering Task Force) standard specifying how a host personal computer interacts with a broadband modem (for example DSL, cable, wireless, etc.) to achieve access to high-speed data networks.

For the service provider, PPPoE offers an access and authentication method that works with existing access control systems (for instance, RADIUS).

One of the benefits of PPPoE is the ability to let end users access one of multiple network services, a function known as dynamic service selection. This enables the service provider to easily create and offer new IP services for specific users.

Operationally, PPPoE saves significant effort for both the subscriber and the ISP/carrier, as it requires no specific configuration of the broadband modem at the subscriber's site.

By implementing PPPoE directly on the NBG (rather than individual computers), the computers on the LAN do not need PPPoE software installed, since the NBG does that part of the task. Furthermore, with NAT, all of the LAN's computers will have Internet access.

Figure 8 Internet Connection Type: PPPoE

Connect to Internet > Router Password > Wireless Security

1

Internet Connection Type :

Please refer to the information provided by your Internet Service Provider (ISP) and complete the following blanks.

User Name : (A-Z ; 0-9)

Password :

Exit Back Next

The following table describes the labels in this screen.

Table 5 Internet Connection Type: PPPoE

LABEL	DESCRIPTION
Internet Connection Type	Select the PPPoE option for a dial-up connection.
User Name	Type the user name given to you by your ISP.
Password	Type the password associated with the user name above.
Exit	Click this to close the wizard screen without saving.
Back	Click this to return to the previous screen.
Next	Click this to continue.

2.3.4 Connection Type: PPTP

Point-to-Point Tunneling Protocol (PPTP) is a network protocol that enables transfers of data from a remote client to a private server, creating a Virtual Private Network (VPN) using TCP/IP-based networks.

PPTP supports on-demand, multi-protocol, and virtual private networking over public networks, such as the Internet.

Refer to the appendix for more information on PPTP.

The NBG supports one PPTP server connection at any given time.

Note: This Internet connection type will be supported in the next firmware version.

Figure 9 Internet Connection Type: PPTP

The following table describes the fields in this screen

Table 6 Internet Connection Type: PPTP

LABEL	DESCRIPTION
Internet Connection Type	Select PPTP from the drop-down list box. To configure a PPTP client, you must configure the User Name and Password fields for a PPP connection and the PPTP parameters for a PPTP connection.
Dynamic IP	Select this radio button if your ISP did not assign you a fixed IP address.

Table 6 Internet Connection Type: PPTP (continued)

LABEL	DESCRIPTION
Static IP	Select this radio button, provided by your ISP to give the NBG a fixed, unique IP address.
PPTP Server IP Address	Type the server IP address of the PPTP server.
User Name	Type the user name given to you by your ISP.
Password	Type the password associated with the User Name above.
PPTP Address	Type the (static) IP address assigned to you by your ISP.
PPTP Subnet Mask	Type the subnet mask assigned to you by your ISP (if given).
PPTP Gateway IP Address	Type the gateway IP address of the PPTP server.
Exit	Click this to close the wizard screen without saving.
Back	Click this to return to the previous screen.
Next	Click this to continue.

The NBG connects to the Internet.

Figure 10 Connecting to the Internet

Note: If the Wizard successfully connects to the Internet, it proceeds to the next step. If you get an error message, go back to the previous screen and make sure you have entered the correct information provided by your ISP.

2.4 Router Password

Change the login password in the following screen. Enter the new password and retype it to confirm. Click **Next** to proceed with the **Wireless Security** screen.

Figure 11 Router Password



2.5 Wireless Security

Configure Wireless Settings. Configure the wireless network settings on your NBG in the following screen. The fields that show up depend on the kind of security you select.

2.5.1 Wireless Security: No Security

Choose **No Security** in the Wireless Security screen to let wireless devices within range access your wireless network.

Figure 12 Wireless Security: No Security



The following table describes the labels in this screen.

Table 7 Wireless Security: No Security

LABEL	DESCRIPTION
Wireless Network Name (SSID)	Enter a descriptive name (up to 32 printable 7-bit ASCII characters) for the wireless LAN. If you change this field on the NBG, make sure all wireless stations use the same SSID in order to access the network.
Security mode	Select a Security level from the drop-down list box. Choose None to have no wireless LAN security configured. If you do not enable any wireless security on your NBG, your network is accessible to any wireless networking device that is within range.
Exit	Click this to close the wizard screen without saving.
Back	Click this to return to the previous screen.
Next	Click this to continue.

2.5.2 Wireless Security: WPA-PSK/WPA2-PSK

Choose **WPA-PSK** or **WPA2-PSK** security in the Wireless Security screen to set up a password for your wireless network.

Figure 13 Wireless Security: WPA-PSK/WPA2-PSK

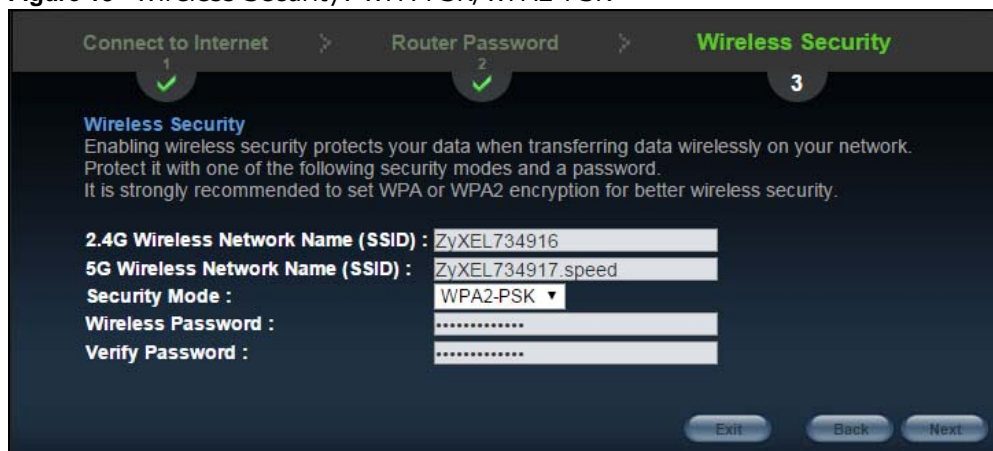

The following table describes the labels in this screen.

Table 8 Wireless Security: WPA-PSK/WPA2-PSK

LABEL	DESCRIPTION
Wireless Network Name (SSID)	Enter a descriptive name (up to 32 printable 7-bit ASCII characters) for the wireless LAN. If you change this field on the NBG, make sure all wireless stations use the same SSID in order to access the network.
Security mode	Select a Security level from the drop-down list box. Choose WPA-PSK or WPA2-PSK security to configure a Pre-Shared Key. Choose this option only if your wireless clients support WPA-PSK or WPA2-PSK respectively.
Wireless password	Type from 8 to 63 case-sensitive ASCII characters. You can set up the most secure wireless connection by configuring WPA in the wireless LAN screens.
Verify Password	Retype the password to confirm.
Exit	Click this to close the wizard screen without saving.

Table 8 Wireless Security: WPA-PSK/WPA2-PSK (continued)

LABEL	DESCRIPTION
Back	Click this to return to the previous screen.
Next	Click this to continue.

Congratulations! Open a web browser, such as Internet Explorer, to visit your favorite website.

Note: If you cannot access the Internet when your computer is connected to one of the NBG's LAN ports, check your connections. Then turn the NBG off, wait for a few seconds then turn it back on. If that does not work, log in to the web configurator again and check you have typed all information correctly. See the User's Guide for more suggestions.

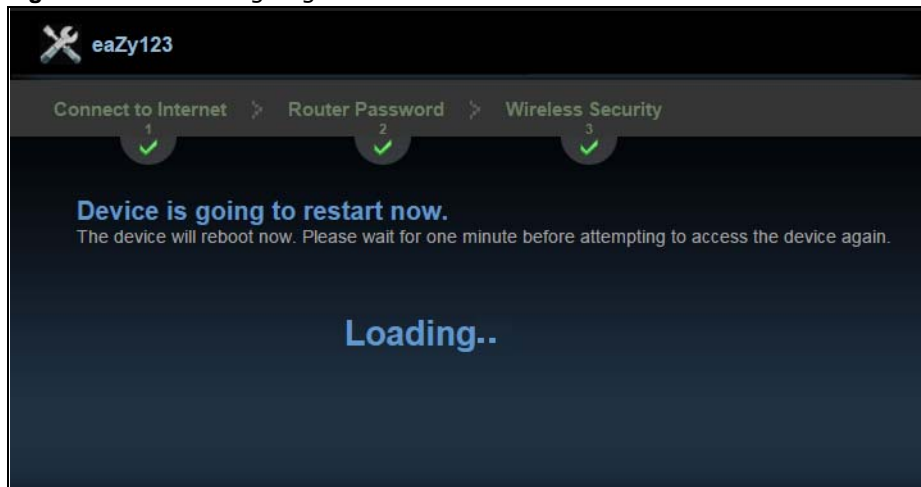
Figure 14 Device is going to restart now

You can also click **GO** to open the **Easy Mode** Web Configurator of your NBG.

You have successfully set up your NBG to operate on your network and access the Internet. You are now ready to connect wirelessly to your NBG and access the Internet.

Introducing the Web Configurator

3.1 Overview

This chapter describes how to access the NBG Web Configurator and provides an overview of its screens.

The Web Configurator is an HTML-based management interface that allows easy setup and management of the NBG via Internet browser. Use Internet Explorer 6.0 and later or Netscape Navigator 7.0 and later versions or Safari 2.0 or later versions. The recommended screen resolution is 1024 by 768 pixels.

In order to use the Web Configurator you need to allow:

- Web browser pop-up windows from your device. Web pop-up blocking is enabled by default in Windows XP SP (Service Pack) 2.
- JavaScript (enabled by default).
- Java permissions (enabled by default).

Refer to the Troubleshooting chapter ([Chapter 26 on page 167](#)) to see how to make sure these functions are allowed in Internet Explorer.

3.2 Accessing the Web Configurator

- 1 Make sure your NBG hardware is properly connected and prepare your computer or computer network to connect to the NBG (refer to the Quick Start Guide).
- 2 Launch your web browser.
- 3 Type "http://192.168.1.1" as the website address.

Your computer must be in the same subnet in order to access this website address.

3.2.1 Login Screen

Note: If this is the first time you are accessing the Web Configurator, you may be redirected to the Wizard. Refer to [Chapter 2 on page 17](#) for the Connection Wizard screens.

The Web Configurator initially displays the following login screen.

Figure 15 Login screen

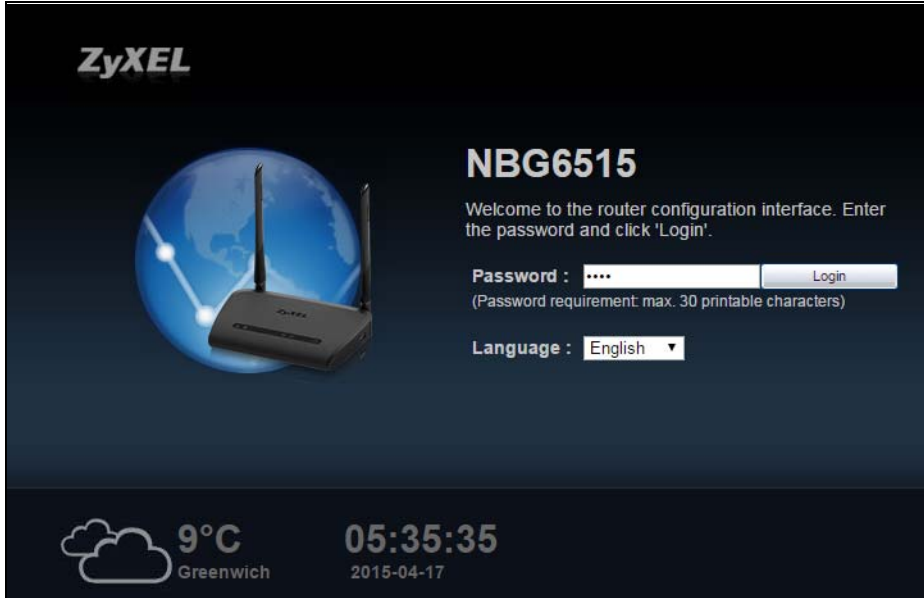

The following table describes the labels in this screen.

Table 9 Login screen

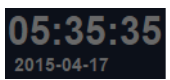
LABEL	DESCRIPTION
Password	Type "1234" (default) as the password.
Language	Select the language you want to use to configure the Web Configurator. Click Login .
	This shows the current weather, either in celsius or fahrenheit, of the city you specify in Section 3.2.3.1 on page 29 .
	This shows the time (hh:mm:ss) and date (yyyy:mm:dd) of the timezone you select in Section 3.2.3.2 on page 29 or Section 25.5 on page 162 . The time is in 24-hour format, for example 15:00 is 3:00 PM.

3.2.2 Password Screen

You should see a screen asking you to change your password (highly recommended) as shown next.

Figure 16 Change Password Screen

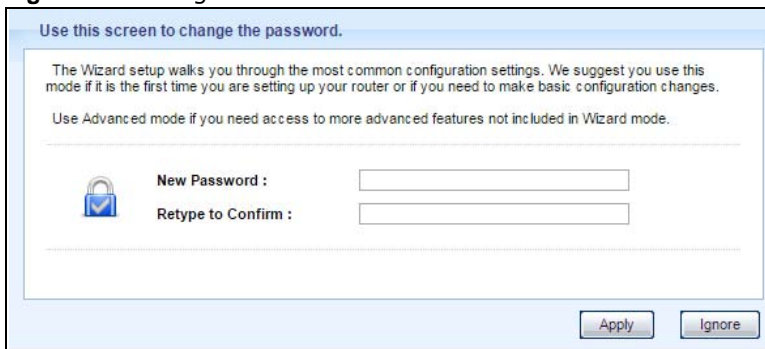

The following table describes the labels in this screen.

Table 10 Change Password Screen

LABEL	DESCRIPTION
New Password	Type a new password.
Retype to Confirm	Retype the password for confirmation.
Apply	Click Apply to save your changes back to the NBG.
Ignore	Click Ignore if you do not want to change the password this time.

Note: The management session automatically times out when the time period set in the **Administrator Inactivity Timer** field expires (default five minutes; go to [Chapter 25 on page 160](#) to change this). Simply log back into the NBG if this happens.

3.2.3 Home Screen

If you have previously logged into the Web Configurator but did not click **Logout**, you may be redirected to the Home screen.

You can also open this screen by clicking **Home** ( Home or  Home) in the Easy Mode or Expert mode screens.

The Home screen displays as follows.

Figure 17 Home Screen

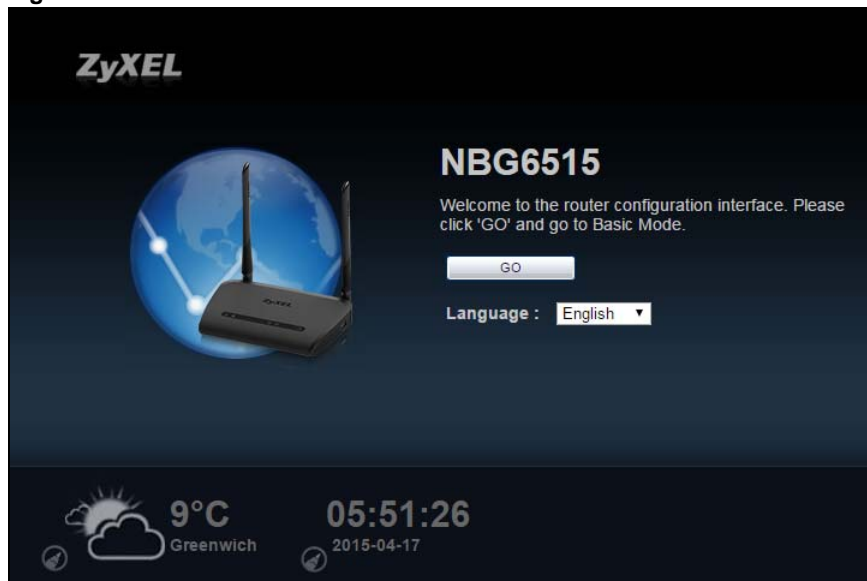

The following table describes the labels in this screen.

Table 11 Home Screen

LABEL	DESCRIPTION
Go	Click this to open the Easy mode Web Configurator.
Language	Select a language to go to the Easy mode Web Configurator.

Table 11 Home Screen (continued)

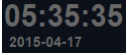
LABEL	DESCRIPTION
	(This is just an example). This shows the current weather, either in celsius or fahrenheit, of the city you specify in Section 3.2.3.1 on page 29 .
	(This is just an example). This shows the time (hh:mm:ss) and date (yyyy:mm:dd) of the timezone you select in Section 3.2.3.2 on page 29 or Section 25.5 on page 162 .

3.2.3.1 Weather Edit

You can change the temperature unit and select the location for which you want to know the weather.

Click the  icon to change the Weather display.

Figure 18 Change Weather

The following table describes the labels in this screen.

Table 12 Change Weather

LABEL	DESCRIPTION
°C or °F	Choose which temperature unit you want the NBG to display.
Change Location	Select the location for which you want to know the weather. If the city you want is not listed, choose one that is closest to it.
Finish	Click this to apply the settings and refresh the date and time display.

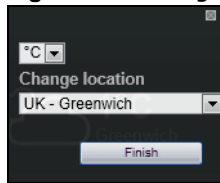
3.2.3.2 Time/Date Edit

One timezone can cover more than one country. You can choose a particular country in which the NBG is located and have the NBG display and use the current time and date for its logs.

Click the  icon to change the Weather display.

Figure 19 Change Password Screen

The following table describes the labels in this screen.

Table 13 Change Password Screen

LABEL	DESCRIPTION
Change time zone	Select the specific country whose current time and date you want the NBG to display.
Finish	Click this to apply the settings and refresh the weather display.

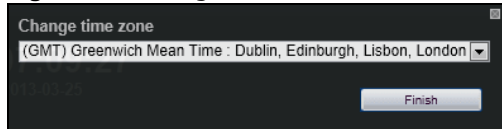
Note: You can also edit the timezone in [Section 25.5 on page 162](#).

3.3 Resetting the NBG

If you forget your password or IP address, or you cannot access the Web Configurator, you will need to use the **RESET** button at the back of the NBG to reload the factory-default configuration file. This means that you will lose all configurations that you had previously saved, the password will be reset to "1234" and the IP address will be reset to "192.168.1.1".

3.3.1 Procedure to Use the Reset Button

- 1 Make sure the power LED is on.
- 2 Press the **RESET** button for longer than 1 second to restart/reboot the NBG.
- 3 Press the **RESET** button for longer than five seconds to set the NBG back to its factory-default configurations.

4.1 Overview

This chapter discusses read-only information related to the device state of the NBG.

Note: To access the Monitor screens, you can also click the links in the Summary table of the Status screen to view the bandwidth consumed, packets sent/received as well as the status of clients connected to the NBG.

4.2 What You Can Do

- Use the **Log** ([Section 4.3 on page 31](#)) screen to see the logs for the activity on the NBG.
- Use the **DHCP Table** screen ([Section 4.4 on page 32](#)) to view information related to your DHCP status.
- Use the **Packet Statistics** screen ([Section 4.5 on page 33](#)) to view port status, packet specific statistics, the "system up time" and so on.
- Use the **WLAN 2.4G Station Status** screen ([Section 4.6 on page 34](#)) to view the wireless stations that are currently associated to the NBG through the wireless 2.4G network.
- Use the **WLAN 5G Station Status** screen ([Section 4.7 on page 35](#)) to view the wireless stations that are currently associated to the NBG through the wireless 5G network.

4.3 The Log Screen

The Web Configurator allows you to look at all of the NBG's logs in one location.

4.3.1 View Log

Use the **View Log** screen to see the logged messages for the NBG. The log wraps around and deletes the old entries after it fills. Select what logs you want to see from the **Display** drop list. Click **Refresh** to renew the log screen. Click **Clear** to delete all the logs.

Figure 20 View Log

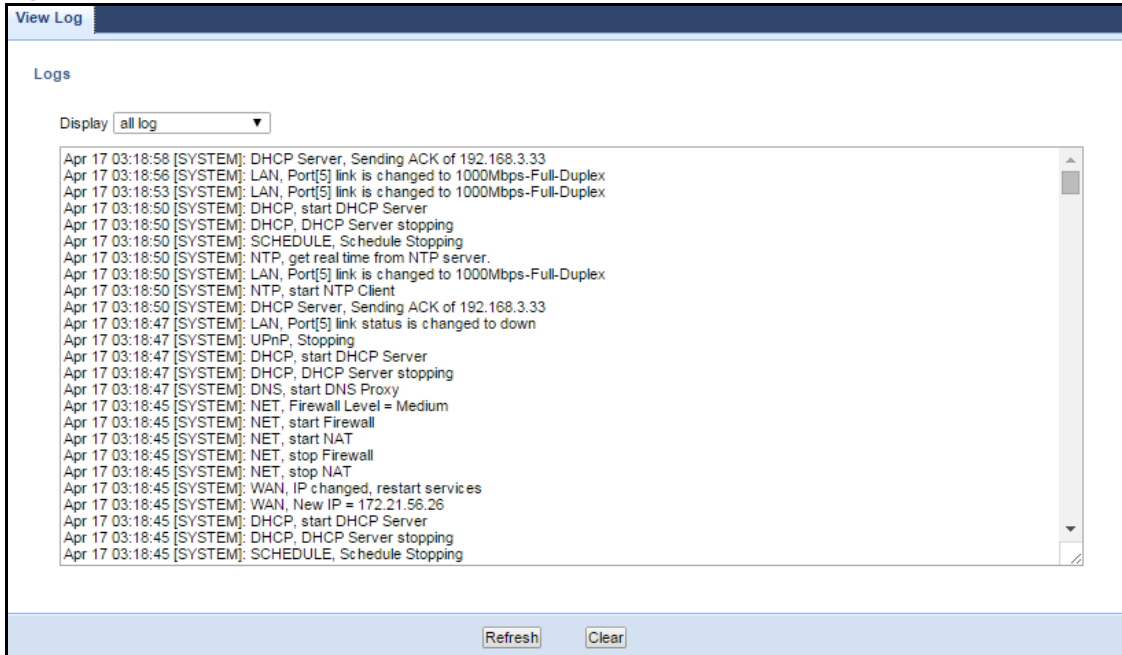

You can configure which logs to display in the **View Log** screen.

4.4 DHCP Table

DHCP (Dynamic Host Configuration Protocol, RFC 2131 and RFC 2132) allows individual clients to obtain TCP/IP configuration at start-up from a server. You can configure the NBG's LAN as a DHCP server or disable it. When configured as a server, the NBG provides the TCP/IP configuration for the clients. If DHCP service is disabled, you must have another DHCP server on that network, or else the computer must be manually configured.

Click the **DHCP Table (Details...)** hyperlink in the **Status** screen. Read-only information here relates to your DHCP status. The DHCP table shows current DHCP client information (including **IP Address**, **Host Name** and **MAC Address**) of all network clients using the NBG's DHCP server.

Figure 21 Summary: DHCP Table

The screenshot shows the 'DHCP Table' interface. At the top, there is a 'DHCP Table' tab. Below it, the text 'DHCP Client Table' is displayed. A 'Table List' section contains a table with the following data:

#	MAC Address	IP Address	Host Name	Expires in
1	C0:3F:D5:BA:9E:B7	192.168.3.33	twpczt02102-01	6 days 21:00:45

At the bottom of the table, there is a 'Refresh' button.

The following table describes the labels in this screen.

Table 14 Summary: DHCP Table

LABEL	DESCRIPTION
#	This is the index number of the host computer.
MAC Address	This field shows the MAC address of the computer with the name in the Host Name field. Every Ethernet device has a unique MAC (Media Access Control) address which uniquely identifies a device. The MAC address is assigned at the factory and consists of six pairs of hexadecimal characters, for example, 00:A0:C5:00:00:02.
IP Address	This field displays the IP address relative to the # field listed above.
Host Name	This field displays the computer host name.
Expires in	This field displays the time when the IP address and MAC address association ends.
Refresh	Click Refresh to renew the screen.

4.5 Packet Statistics

Click the **Packet Statistics (Details...)** hyperlink in the **Status** screen. Read-only information here includes port status, packet specific statistics and the "system up time". The **Poll Interval(s)** field is configurable and is used for refreshing the screen.

Figure 22 Summary: Packet Statistics

The screenshot shows the 'Packet Statistics' interface. It features a table with the following data:

Port	Status	TxPkts	RxPkts	Collisions	Tx kb/s	Rx kb/s
WAN	1000Mbps Full-Duplex	152961	549983	0	23728.74	84482.81
LAN	1000Mbps Full-Duplex	266737	249461	0	157081.67	34014.91
WLAN 2.4G	Down	0	0	0	0.00	0.00
WLAN 5G	Down	0	0	0	0.00	0.00

Below the table, the 'System Up Time' is displayed as 02d:01h:04m:44s. At the bottom, there is a 'Poll Interval(s)' dropdown menu set to 'None' and a 'Refresh Now' button.

The following table describes the labels in this screen.

Table 15 Summary: Packet Statistics

LABEL	DESCRIPTION
Port	This is the NBG's port type.
Status	For the LAN ports, this displays the port speed and duplex setting or Down when the line is disconnected. For the WAN port, it displays the port speed and duplex setting if you're using Ethernet encapsulation and Idle (line (ppp) idle), Dial (starting to trigger a call) and Drop (dropping a call) if you're using PPPoE or PPTP encapsulation. This field displays Down when the line is disconnected. For WLAN 2.4G/5G, it displays the maximum transmission rate when the WLAN 2.4G/5G is enabled and Down when the WLAN 2.4G/5G is disabled.
TxPkts	This is the number of transmitted packets on this port.
RxPkts	This is the number of received packets on this port.
Collisions	This is the number of collisions on this port.
Tx kb/s	This displays the transmission speed in bytes per second on this port.
Rx kb/s	This displays the reception speed in bytes per second on this port.
System Up Time	This is the total time the NBG has been on.
Poll Interval(s)	Enter the time interval in seconds for refreshing statistics in this field.
Refresh Now	Click Refresh Now to renew the screen.

4.6 WLAN 2.4G Station Status

Click the **WLAN 2.4G Station Status (Details...)** hyperlink in the **Status** screen. View the wireless stations that are currently associated to the NBG in the **Association List**. Association means that a wireless client (for example, your network or computer with a wireless network card) has connected successfully to the AP (or wireless router) using the same SSID, channel and security settings.

Figure 23 Summary: Wireless Association List

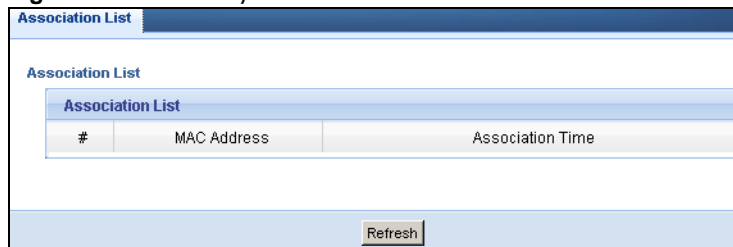

The following table describes the labels in this screen.

Table 16 Summary: Wireless Association List

LABEL	DESCRIPTION
#	This is the index number of an associated wireless station.
MAC Address	This field displays the MAC address of an associated wireless station.

Table 16 Summary: Wireless Association List (continued)

LABEL	DESCRIPTION
Association Time	This field displays the time a wireless station first associated with the NBG's WLAN network.
Refresh	Click Refresh to reload the list.

4.7 WLAN 5G Station Status

Click the **WLAN 5G Station Status (Details...)** hyperlink in the **Status** screen. View the wireless stations that are currently associated to the NBG in the **Association List**. Association means that a wireless client (for example, your network or computer with a wireless network card) has connected successfully to the AP (or wireless router) using the same SSID, channel and security settings.

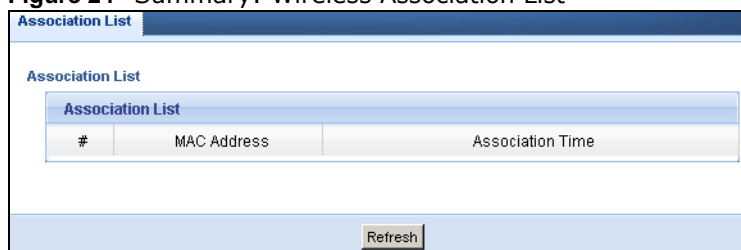
Figure 24 Summary: Wireless Association List

The following table describes the labels in this screen.

Table 17 Summary: Wireless Association List

LABEL	DESCRIPTION
#	This is the index number of an associated wireless station.
MAC Address	This field displays the MAC address of an associated wireless station.
Association Time	This field displays the time a wireless station first associated with the NBG's WLAN network.
Refresh	Click Refresh to reload the list.

NBG Modes

5.1 Overview

This chapter introduces the different modes available on your NBG. First, the term “mode” refers to two things in this User’s Guide.

- **Web Configurator mode.** This refers to the Web Configurator interface you want to use for editing NBG features.
- **Device mode.** This is the operating mode of your NBG, or simply how the NBG is being used in the network.

5.1.1 Web Configurator Modes

This refers to the configuration interface of the Web Configurator, which has two modes:

- **Easy.** The Web Configurator shows this mode by default. Refer to [Chapter 6 on page 37](#) for more information on the screens in this mode. This interface may be sufficient for users who just want to use the device.
- **Expert.** Advanced users can change to this mode to customize all the functions of the NBG. Click **Expert Mode** after logging into the Web Configurator. The User’s Guide [Chapter 3 on page 26](#) through [Chapter 25 on page 160](#) discusses the screens in this mode.

5.1.2 Device Modes

This refers to the operating mode of the NBG, which can act as a:

- **Router.** This is the default device mode of the NBG. Use this mode to connect the local network to another network, like the Internet. Go to [Section 7.3 on page 49](#) to view the **Status** screen in this mode.
- **Access Point.** Use this mode if you want to extend your network by allowing network devices to connect to the NBG wirelessly. Go to [Section 8.4 on page 57](#) view the **Status** screen in this mode.
- **Universal Repeater:** In this mode, the NBG can be an access point and a wireless client at the same time. Use this mode if there is an existing wireless router or access point in your network and you also want to allow clients to connect to the NBG. Go to [Section 9.5 on page 64](#) to view the **Status** screen in this mode.

The menu for changing device modes is available in **Expert** mode only.

Note: Choose your Device Mode carefully to avoid having to change it later.

When changing to another mode, the IP address of the NBG changes. The running applications and services of the network devices connected to the NBG can be interrupted.

Easy Mode

6.1 Overview

The Web Configurator is set to **Easy Mode** by default. You can configure several key features of the NBG in this mode. This mode is useful to users who are not fully familiar with some features that are usually intended for network administrators.

When you log in to the Web Configurator, the following screen opens.

Figure 25 Easy Mode: Network Map

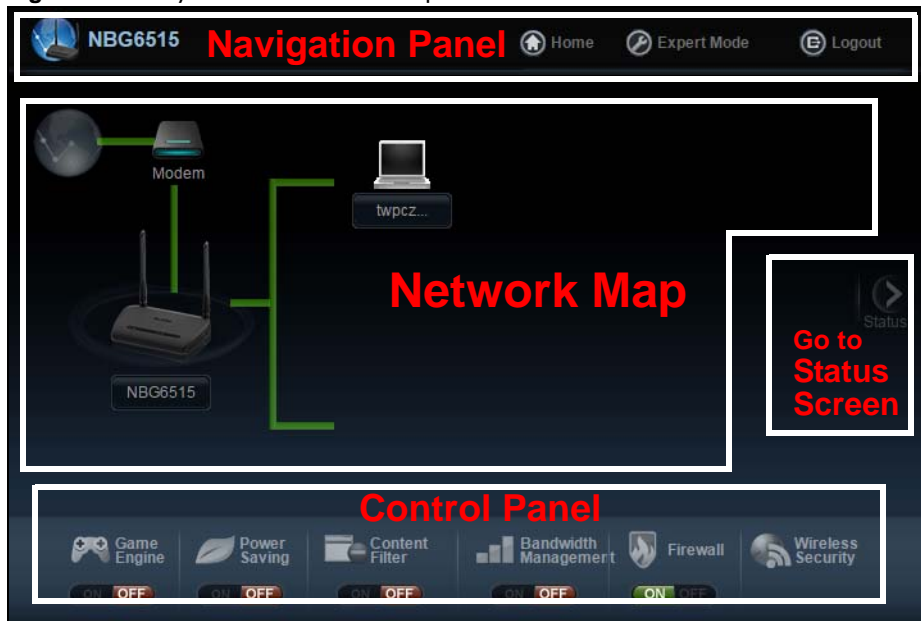

Click **Status** to open the following screen screen.

Figure 26 Easy Mode: Status Screen



Click **NBG6515** to open the pop up menu.

Figure 27 Easy Mode: Pop Up Menu

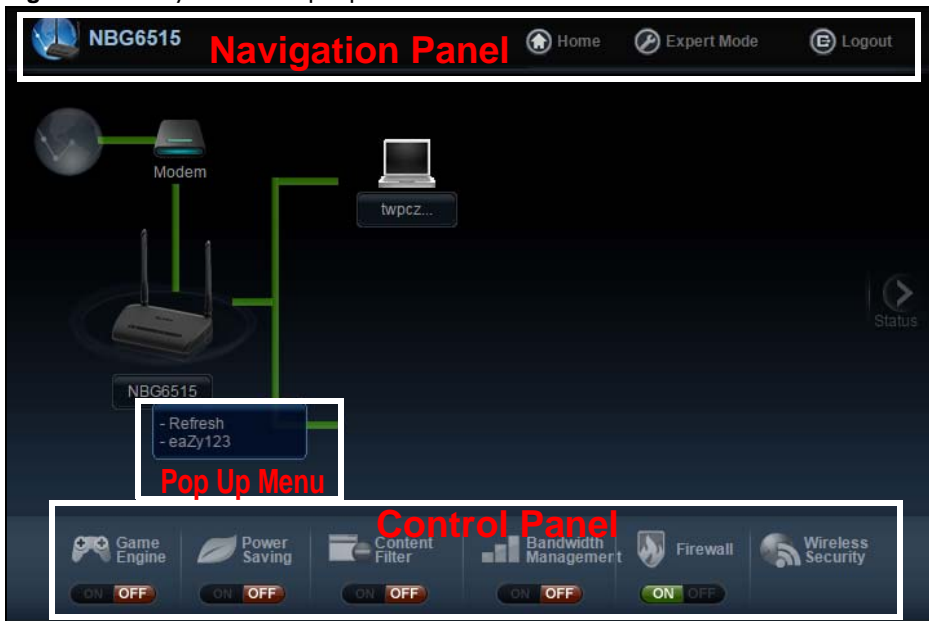

6.2 What You Can Do

You can do the following in this mode:

- Use this **Navigation Panel** ([Section 6.4 on page 39](#)) to opt out of the **Easy** mode.
- Use the **Network Map** screen ([Section 6.5 on page 39](#)) to check if your NBG can ping the gateway and whether it is connected to the Internet.
- Use the **Control Panel** ([Section 6.6 on page 40](#)) to configure and enable NBG features, including wireless security, wireless scheduling and bandwidth management and so on.
- Use the **Status Screen** screen ([Section 6.7 on page 47](#)) to view read-only information about the NBG, including the WAN IP, MAC Address of the NBG and the firmware version.
- Use the **Pop Up Menu** to refresh the Router or run the **eaZy123** wizard ([Section 2.2 on page 17](#)).

6.3 What You Need to Know

Between the different device modes, the Control Panel ([Section 6.6 on page 40](#)) changes depending on which features are applicable to the mode:

- **Router Mode:** All Control Panel features are available.
- **Access Point Mode:** Only **Power Saving** and **Wireless Security** are available.

6.4 Navigation Panel

Use this navigation panel to opt out of the **Easy** mode.

Figure 28 Navigation Panel



The following table describes the labels in this screen.

Table 18 Navigation Panel

ITEM	DESCRIPTION
Home	Click this to go to the Login page.
Expert Mode	Click this to change to Expert mode and customize features of the NBG.
Logout	Click this to end the Web Configurator session.

6.5 Network Map

Note: The Network MAP is viewable by Windows XP (need to install patch), Windows Vista and Windows 7 users only. For Windows XP (Service Pack 2) users, you can see the network devices connected to the NBG by downloading the LLTD (Link Layer Topology Discovery) patch from the Microsoft Website.

Note: Don't worry if the Network Map does not display in your web browser. This feature may not be supported by your system. You can still configure the Control Panel (Section 6.6 on page 40) in the Easy Mode and the NBG features that you want to use in the Expert Mode.

When you log into the Network Configurator, the Network Map is shown as follows.

Figure 29 Network Map

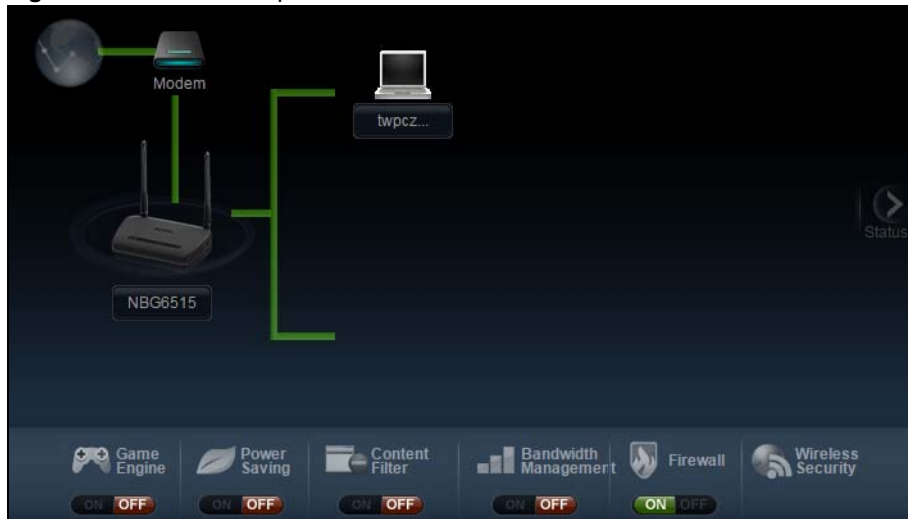

The line connecting the NBG to the gateway becomes green when the NBG is able to ping the gateway. It becomes red when the ping initiating from the NBG does not get a response from the gateway. The same rule applies to the line connecting the gateway to the Internet.

You can also view the devices (represented by icons indicating the kind of network device) connected to the NBG, including those connecting wirelessly. Right-click on the NBG icon to refresh the network map and go to the Wizard. Right click on the other icons to view information about the device.

6.6 Control Panel

The features configurable in **Easy Mode** are shown in the **Control Panel**.

Figure 30 Control Panel

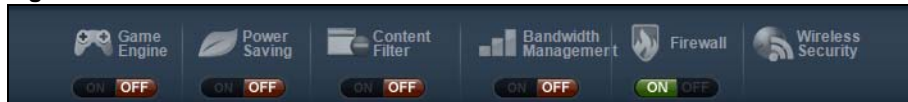

Switch **ON** to enable the feature. Otherwise, switch **OFF**. If the feature is turned on, the green light flashes. If it is turned off, the red light flashes.

Additionally, click the feature to open a screen where you can edit its settings.

The following table describes the labels in this screen.

Table 19 Control Panel

ITEM	DESCRIPTION
Game Engine	Switch ON to maximize bandwidth for gaming traffic in your network. Otherwise, switch OFF . Refer to Section 6.6.1 on page 41 to see this screen.
Power Saving	Click this to schedule the wireless feature of the NBG. Disabling the wireless function helps lower the energy consumption of the NBG. Switch ON to apply wireless scheduling. Otherwise, switch OFF . Refer to Section 6.6.2 on page 42 to see this screen.
Content Filter	Click this to restrict access to certain websites, based on keywords contained in URLs, to which you do not want users in your network to open. Switch ON to apply website filtering. Otherwise, switch OFF . Refer to Section 6.6.3 on page 43 to see this screen.
Bandwidth Management	Click this to edit bandwidth management for predefined applications. Switch ON to have the NBG management bandwidth for uplink and downlink traffic according to an application or service. Otherwise, switch OFF . Refer to Section 6.6.4 on page 44 to see this screen.
Firewall	Switch ON to ensure that your network is protected from Denial of Service (DoS) attacks. Otherwise, switch OFF . Refer to Section 6.6.5 on page 44 to see this screen.
Wireless Security	Click this to configure the wireless security, such as SSID, security mode and WPS key on your NBG. Refer to Section 6.6.6 on page 45 to see this screen.

6.6.1 Game Engine

When this feature is enabled, the NBG maximizes the bandwidth for gaming traffic that it forwards out through an interface.

Figure 31 Game Engine

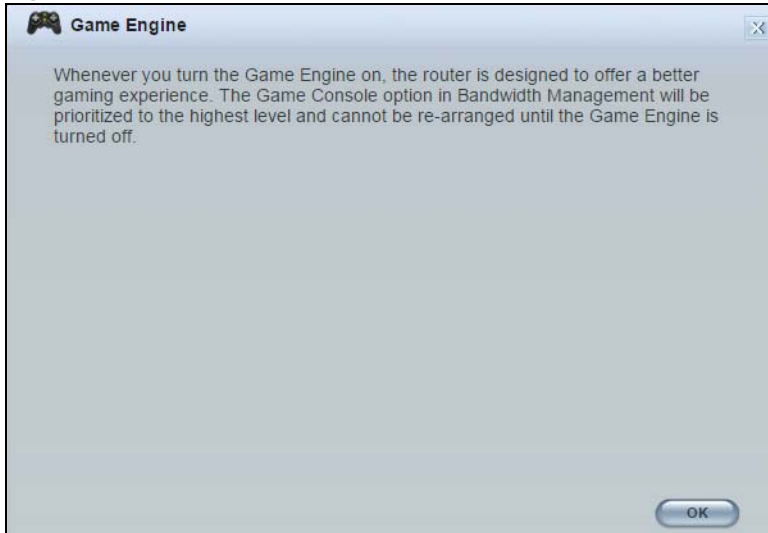

Note: When this is switched on, the **Game Console** tab in the **Bandwidth Management** screen is automatically positioned on top.

Turn this off if your network is not using gaming.

Click **OK** to close this screen.

6.6.2 Power Saving

Use this screen to set the day of the week and time of the day when your wireless LAN is turned on and off. Wireless LAN scheduling is disabled by default.

Disabling the wireless capability lowers the energy consumption of the of the NBG.

Figure 32 Power Saving



The following table describes the labels in this screen.

Table 20 Power Saving

LABEL	DESCRIPTION
Wireless Radio	Select the wireless radio to set its power saving settings.
WLAN Status	Select On or Off to specify whether the Wireless LAN is turned on or off (depending on what you selected in the WLAN Status field). This field works in conjunction with the Day and Except for the following times fields.
Day	Select Everyday or the specific days to turn the Wireless LAN on or off. If you select Everyday you can not select any specific days. This field works in conjunction with the Except for the following times field.
For the following times (24-Hour Format)	Select a begin time using the first set of hour and minute (min) drop down boxes and select an end time using the second set of hour and minute (min) drop down boxes. If you have chosen On earlier for the WLAN Status the Wireless LAN will turn on between the two times you enter in these fields. If you have chosen Off earlier for the WLAN Status the Wireless LAN will turn off between the two times you enter in these fields. In this time format, midnight is 00:00 and progresses up to 24:00. For example, 6:00 PM is 18:00.
Apply	Click Apply to save your changes back to the NBG.
Cancel	Click Cancel to close this screen.

6.6.3 Content Filter

Use this screen to restrict access to certain websites, based on keywords contained in URLs, to which you do not want users in your network to open.

Figure 33 Content Filter



The following table describes the labels in this screen.

Table 21 Content Filter

LABEL	DESCRIPTION
Add	Click Add after you have typed a keyword. Repeat this procedure to add other keywords. Up to 64 keywords are allowed. Note: The NBG does not recognize wildcard characters as keywords. When you try to access a web page containing a keyword, you will get a message telling you that the content filter is blocking this request.
Delete	Highlight a keyword in the text box and click Delete to remove it. The keyword disappears from the text box after you click Apply .
Apply	Click Apply to save your changes.
Cancel	Click Cancel to close this screen without saving any changes.

6.6.4 Bandwidth Management

Use this screen to set bandwidth allocation to pre-defined services and applications for bandwidth allocation.

The NBG uses bandwidth management for incoming and outgoing traffic. Rank the services and applications by dragging them accordingly from **High** to **Low** and click **Apply**. Click **Cancel** to close the screen.

Figure 34 Bandwidth Management

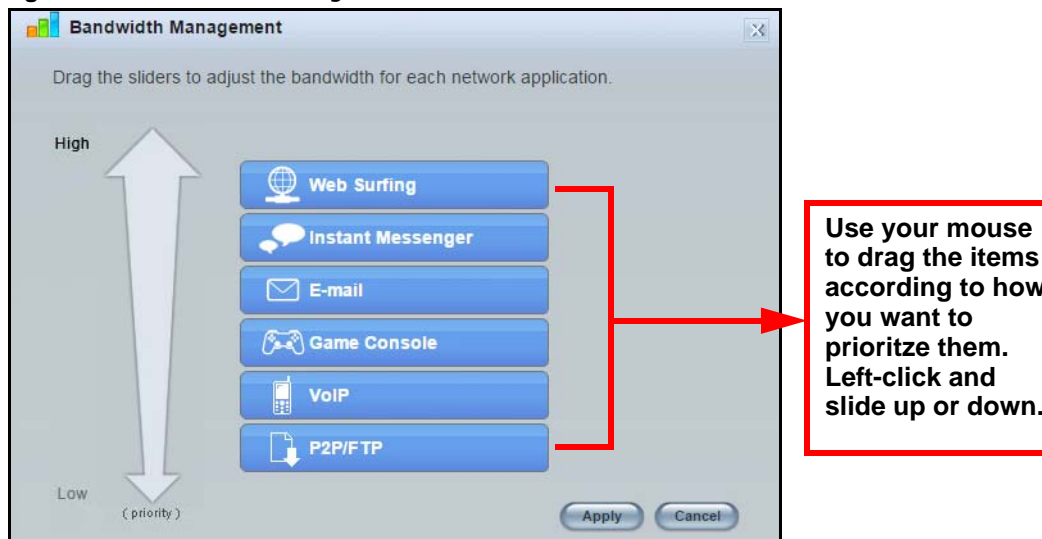

6.6.5 Firewall

Enable this feature to protect the network from Denial of Service (DoS) attacks. The NBG blocks repetitive pings from the WAN that can otherwise cause systems to slow down or hang.

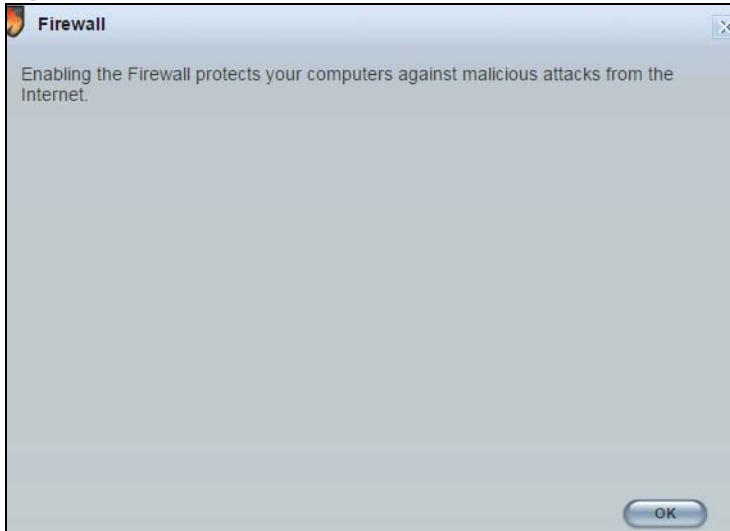
Figure 35 Firewall

Click **OK** to close this screen.

6.6.6 Wireless Security

Use this screen to configure security for your the Wireless LAN. You can enter the SSID and select the wireless security mode in the following screen.

Note: You can enable the Wireless function of your NBG by first turning on the switch in the back panel.

Figure 36 Wireless Security

The following table describes the general wireless LAN labels in this screen.

Table 22 Wireless Security

LABEL	DESCRIPTION
Wireless Radio	Select the wireless radio to set its security setting.
Wireless Network Name (SSID)	(Service Set IDentity) The SSID identifies the Service Set with which a wireless station is associated. Wireless stations associating to the access point (AP) must have the same SSID. Enter a descriptive name (up to 32 keyboard characters) for the wireless LAN.
Security Mode	Select WPA-PSK or WPA2-PSK to add security on this wireless network. The wireless clients which want to associate to this network must have same wireless security settings as this device. After you select to use a security, additional options appears in this screen. Select No Security to allow any client to connect to this network without authentication.
Wireless Password	This field appears when you choose wither WPA-PSK or WPA2-PSK as the security mode. Type a pre-shared key from 8 to 63 case-sensitive keyboard characters.
Verify Password	Type the password again to confirm.
Apply	Click Apply to save your changes back to the NBG.
Cancel	Click Cancel to close this screen.
WPS	Click this to configure the WPS screen. You can transfer the wireless settings configured here (Wireless Security screen) to another wireless device that supports WPS.

6.6.7 WPS

Use this screen to add a wireless station to the network using WPS. Click **WPS** in the **Wireless Security** to open the following screen.

Figure 37 Wireless Security: WPS



The following table describes the labels in this screen.

Table 23 Wireless Security: WPS

LABEL	DESCRIPTION
Wireless Security	Click this to go back to the Wireless Security screen.
WPS	<p>Create a secure wireless network simply by pressing a button.</p> <p>The NBG scans for a WPS-enabled device within the range and performs wireless security information synchronization.</p> <p>Note: After you click the WPS button on this screen, you have to press a similar button in the wireless station utility within 2 minutes. To add the second wireless station, you have to press these buttons on both device and the wireless station again after the first 2 minutes.</p>
Register	<p>Create a secure wireless network simply by entering a wireless client's PIN (Personal Identification Number) in the NBG's interface and pushing this button.</p> <p>Type the same PIN number generated in the wireless station's utility. Then click Register to associate to each other and perform the wireless security information synchronization.</p>
Exit	Click Exit to close this screen.

6.7 Status Screen in Easy Mode

In the Network Map screen, click **Status** to view read-only information about the NBG.

Figure 38 Status Screen in Easy Mode



Name :	NBG6515
Time :	1970-01-01 00:09:58
WAN IP :	—
MAC Address :	EC:43:F6:73:49:15
Firmware Version :	V1.00(AAXS.0)B7
Wireless 2.4G Network Name (SSID) :	ZyXEL734916
Security :	WPA2-PSK
Wireless 5G Network Name (SSID) :	ZyXEL734917.speed
Security :	WPA2-PSK

The following table describes the labels in this screen.

Table 24 Status Screen in Easy Mode

ITEM	DESCRIPTION
Name	This is the name of the NBG in the network. You can change this in the Maintenance > General screen in Section 25.3 on page 160 .
Time	<p>This is the current system date and time.</p> <p>The date is in YYYY:MM:DD (Year-Month-Day) format. The time is in HH:MM:SS (Hour:Minutes:Seconds) format.</p>
WAN IP	This is the IP address of the WAN port.
MAC Address	This is the MAC address of the NBG.
Firmware Version	<p>This shows the firmware version of the NBG.</p> <p>The firmware version format shows the trunk version, model code and release number.</p>

Table 24 Status Screen in Easy Mode (continued)

ITEM	DESCRIPTION
Wireless 2.4G Network Name (SSID)	This shows the SSID of the wireless 2.4G network. You can configure this in the Wireless Security screen (Section 6.6.6 on page 45 ; Section 11.3.1.1 on page 81).
Security	This shows the wireless security used by the NBG for the 2.4G wireless radio.
Wireless 5G Network Name (SSID)	This shows the SSID of the wireless 5G network. You can configure this in the Wireless Security screen (Section 6.6.6 on page 45 ; Section 11.3.1.1 on page 81).
Security	This shows the wireless security used by the NBG for the 5G wireless radio.

Router Mode

7.1 Overview

The NBG is set to router mode by default. Routers are used to connect the local network to another network (for example, the Internet). In the figure below, the NBG connects the local network (**LAN1 ~ LAN4**) to the Internet.

Figure 39 NBG Network

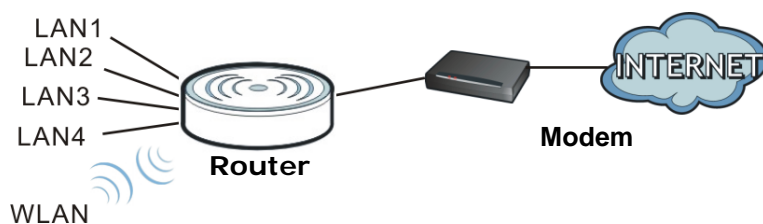

Note: The Status screen is shown after changing to the Expert mode of the Web Configurator. It varies depending on the device mode of your NBG.

7.2 What You Can Do

Use the **Status** screen ([Section 7.3 on page 49](#)) to view read-only information about your NBG.

7.3 Status Screen

Click  to open the status screen.





Figure 40 Status Screen: Router Mode

The following table describes the icons shown in the **Status** screen.

Table 25 Status Screen Icon Key: Router Mode

ICON	DESCRIPTION
	Click this icon to view copyright and a link for related product information.
	Click this icon to go to Easy Mode. See Chapter 6 on page 37 .
	Click this to go to the Home page. See Chapter 4 on page 31 .
	Select a number of seconds or None from the drop-down list box to refresh all screen statistics automatically at the end of every time interval or to not refresh the screen statistics.
	Click this button to refresh the status screen statistics.

Table 25 Status Screen Icon Key: Router Mode (continued)

ICON	DESCRIPTION
	Click this icon to see the Status page. The information in this screen depends on the device mode you select.
	Click this icon to see the Monitor navigation menu.
	Click this icon to see the Configuration navigation menu.
	Click this icon to see the Maintenance navigation menu.

The following table describes the labels shown in the **Status** screen.

Table 26 Status Screen: Router Mode

LABEL	DESCRIPTION
Logout	Click this at any time to exit the Web Configurator.
Device Information	
Host Name	This is the System Name you enter in the Maintenance > General screen. It is for identification purposes.
Firmware Version	This is the firmware version and the date created.
Sys OP Mode	This is the device mode (Section 5.1.2 on page 36) to which the NBG is set - Router Mode .
WAN Information	
- MAC Address	This shows the WAN Ethernet adapter MAC Address of your device.
- IP Address	This shows the WAN port's IP address.
- IP Subnet Mask	This shows the WAN port's subnet mask.
- Default Gateway	This shows the WAN port's gateway IP address.
- DHCP	This shows the LAN port's DHCP role - Client or Server .
LAN Information	
- MAC Address	This shows the LAN Ethernet adapter MAC Address of your device.
- IP Address	This shows the LAN port's IP address.
- IP Subnet Mask	This shows the LAN port's subnet mask.
- DHCP	This shows the LAN port's DHCP role - Server or None .
WLAN 2.4G Information	
- MAC Address	This shows the wireless adapter MAC Address of your device.
- SSID	This shows a descriptive name used to identify the NBG in the wireless LAN. The default SSID is ZyXEL and the last 6 digits of the 2.4G MAC address (for example, ZyXEL734916).
- Channel	This shows the channel number which the NBG is currently using over the wireless LAN.
- Security	This shows the level of wireless security the NBG is using.
WLAN 5G Information	
- MAC Address	This shows the wireless adapter MAC Address of your device.
- SSID	This shows a descriptive name used to identify the NBG in the wireless LAN. The default SSID is ZyXEL, the last 6 digits of the 5G MAC address, and .speed (for example, ZyXEL734917.speed).
- Channel	This shows the channel number which the NBG is currently using over the wireless LAN.
- Security	This shows the level of wireless security the NBG is using.
System Status	

Table 26 Status Screen: Router Mode (continued)

LABEL	DESCRIPTION
Item	This column shows the type of data the NBG is recording.
Data	This column shows the actual data recorded by the NBG.
System Up Time	This is the total time the NBG has been on.
Current Date/Time	This field displays your NBG's present date and time.
System Resource	
- CPU Usage	This displays what percentage of the NBG's processing ability is currently used. When this percentage is close to 100%, the NBG is running at full load, and the throughput is not going to improve anymore. If you want some applications to have more throughput, you should turn off other applications (for example, using bandwidth management.)
- Memory Usage	This shows what percentage of the heap memory the NBG is using.
System Setting	
- Firewall	This shows whether the firewall is enabled or not.
- Bandwidth Management	This shows whether the bandwidth management is enabled or not.
- UPnP	This shows whether UPnP is enabled or not.
- Configuration Mode	This shows the web configurator mode you are viewing - Expert .
IPv6 Status	
Item	This column shows the type of data the IPv6 is using.
Data	This column shows the actual data used through the IPv6.
Interface Status	
Interface	This displays the NBG port types. The port types are: WAN , LAN and WLAN .
Status	For the LAN and WAN ports, this field displays Down (line is down) or Up (line is up or connected). For the WLAN, it displays Up when the WLAN is enabled or Down when the WLAN is disabled.
Rate	For the LAN ports, this displays the port speed and duplex setting or N/A when the line is disconnected. For the WAN port, it displays the port speed and duplex setting if you're using Ethernet encapsulation and Idle (line (ppp) idle), Dial (starting to trigger a call) and Drop (dropping a call) if you're using PPPoE or PPTP encapsulation. This field displays N/A when the line is disconnected. For the WLAN, it displays the maximum transmission rate when the WLAN is enabled and N/A when the WLAN is disabled.
Summary	
DHCP Table	Click Details... to go to the Monitor > DHCP Table screen (Section 4.4 on page 32). Use this screen to view current DHCP client information.
Packet Statistics	Click Details... to go to the Monitor > Packet Statistics screen (Section 4.5 on page 33). Use this screen to view port status and packet specific statistics.
WLAN Station Status	Click Details... to go to the Monitor > WLAN 2.4G / 5G Station Status screen (Section 4.7 on page 35). Use this screen to view the wireless stations that are currently associated to the NBG.

7.3.1 Navigation Panel

Use the sub-menus on the navigation panel to configure NBG features.

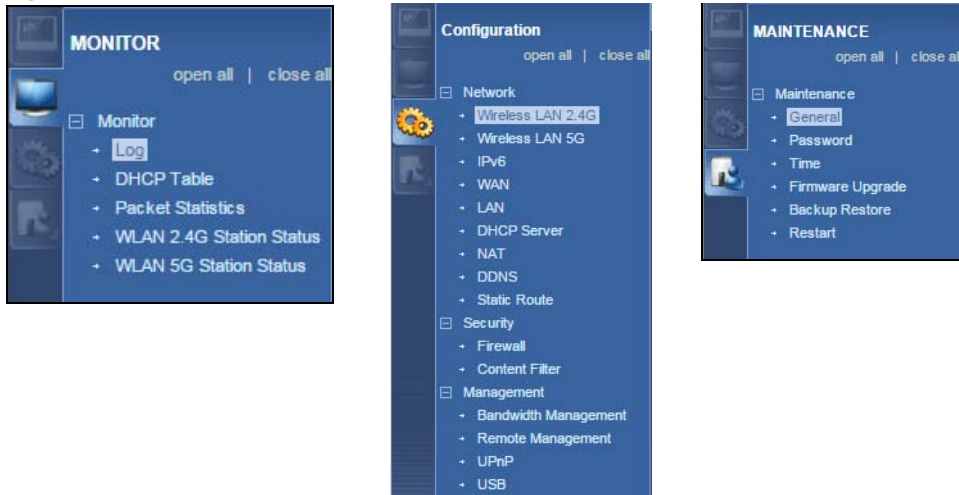
Figure 41 Navigation Panel: Router Mode

The following table describes the sub-menus.

Table 27 Navigation Panel: Router Mode

LINK	TAB	FUNCTION
Status		This screen shows the NBG's general device, system and interface status information. Use this screen to access the wizard, and summary statistics tables.
MONITOR		
Log		Use this screen to view the list of activities recorded by your NBG.
DHCP Table		Use this screen to view current DHCP client information.
Packet Statistics		Use this screen to view port status and packet specific statistics.
WLAN 2.4G Station Status		Use this screen to view the wireless stations that are currently associated to the NBG through the wireless 2.4G network.
WLAN 5G Station Status		Use this screen to view the wireless stations that are currently associated to the NBG through the wireless 5G network.
CONFIGURATION		
Network		
Wireless LAN 2.4G	General	Use this screen to configure wireless 2.4G LAN.
	MAC Filter	Use the MAC filter screen to configure the NBG to block access to devices or block the devices from accessing the NBG.
	Advanced	This screen allows you to configure advanced wireless settings.
	QoS	Use this screen to configure Wi-Fi Multimedia Quality of Service (WMM QoS). WMM QoS allows you to prioritize wireless traffic according to the delivery requirements of individual services.
	WPS	Use this screen to configure WPS.
	WPS Device	Use this screen to add a wireless station using WPS.
	Scheduling	Use this screen to schedule the times the Wireless LAN is enabled.
	Guest WLAN	Use this screen to configure multiple BSSs on the NBG.

Table 27 Navigation Panel: Router Mode (continued)

LINK	TAB	FUNCTION
Wireless LAN 5G	General	Use this screen to configure wireless 5G LAN.
	MAC Filter	Use the MAC filter screen to configure the NBG to block access to devices or block the devices from accessing the NBG.
	Advanced	This screen allows you to configure advanced wireless settings.
	QoS	Use this screen to configure Wi-Fi Multimedia Quality of Service (WMM QoS). WMM QoS allows you to prioritize wireless traffic according to the delivery requirements of individual services.
	WPS	Use this screen to configure WPS.
	WPS Device	Use this screen to add a wireless station using WPS.
	Scheduling	Use this screen to schedule the times the Wireless LAN is enabled.
	Guest WLAN	Use this screen to configure multiple BSSs on the NBG.
IPv6	General	Use this screen to configure the IPv6 connection type.
WAN	Internet Connection	This screen allows you to configure ISP parameters, WAN IP address assignment, DNS servers and the WAN MAC address.
	Advanced	Use this screen to configure other advanced properties.
LAN	IP	Use this screen to configure LAN IP address and subnet mask.
DHCP Server	General	Use this screen to enable the NBG's DHCP server.
	Advanced	Use this screen to assign IP addresses to specific individual computers based on their MAC addresses and to have DNS servers assigned by the DHCP server.
NAT	General	Use this screen to enable NAT.
	Application	Use this screen to configure servers behind the NBG.
	Advanced	Use this screen to change your NBG's port triggering settings.
DDNS	General	Use this screen to set up dynamic DNS.
Static Route	IP Static Route	Use this screen to configure IP static routes.
Security		
Firewall	General	Use this screen to activate/deactivate the firewall.
	MAC Filtering Rule	Use the MAC filtering rule screen to configure the NBG to block access to devices or block the devices from accessing the NBG.
	IP Filtering Rule	Use the IP filtering rule screen to configure the NBG to block access to devices or block the devices from accessing the NBG.
Content Filter		Use this screen to block certain web features and sites containing certain keywords in the URL.
Management		
Bandwidth Management	General	Use this screen to enable bandwidth management.
	Advanced	Use this screen to set the upstream bandwidth and edit a bandwidth management rule.
Remote Management	WWW	Use this screen to be able to access the NBG from the LAN, WAN or both.
UPnP	General	Use this screen to enable UPnP on the NBG.
USB	SMB/CIFS	Use this screen to enable file sharing through the NBG.
	DLNA	Use this screen to have the NBG function as a DLNA-compliant media server, that lets DLNA-compliant media clients play video, audio, and photo content files stored on the connected USB storage device.
	FTP	Use this screen to have the NBG act as a FTP server.

Table 27 Navigation Panel: Router Mode (continued)

LINK	TAB	FUNCTION
MAINTENANCE		
General		Use this screen to view and change administrative settings such as system and domain names.
Password	Password Setup	Use this screen to change the password of your NBG.
Time	Time Setting	Use this screen to change your NBG's time and date.
Firmware Upgrade		Use this screen to upload firmware to your NBG.
Backup Restore		Use this screen to backup and restore the configuration or reset the factory defaults to your NBG.
Restart		This screen allows you to reboot the NBG without turning the power off.

Access Point Mode

8.1 Overview

Use your NBG as an access point (AP) if you already have a router or gateway on your network. In this mode your NBG bridges a wired LAN and wireless LAN (WLAN) in the same subnet. See the figure below for an example.

Figure 42 Wireless Internet Access in Access Point Mode

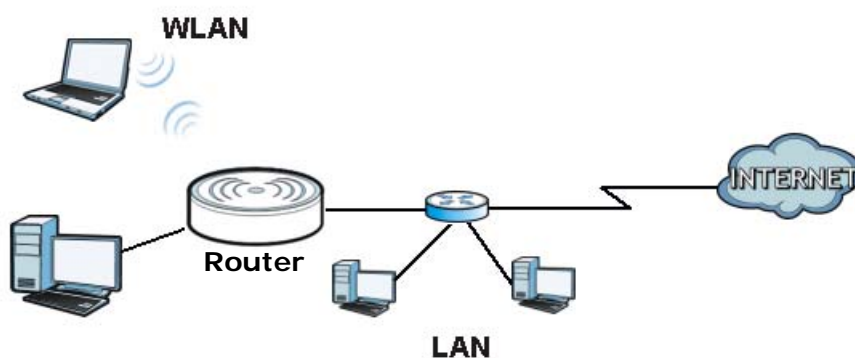

Many screens that are available in Router mode are not available in Access Point mode, such as bandwidth management and firewall.

Note: See [Chapter 10 on page 72](#) for an example of setting up a wireless network in Access Point mode.

8.2 What You Can Do

- Use the **Status** screen ([Section 8.4 on page 57](#)) to view read-only information about your NBG.
- Use the **LAN** screen ([Section 8.5 on page 60](#)) to set the IP address for your NBG acting as an access point.

8.3 What You Need to Know

See [Chapter 10 on page 72](#) for a tutorial on setting up a network with the NBG as an access point.

8.3.1 Setting your NBG to AP Mode

- 1 Log into the Web Configurator if you haven't already. See the Quick start Guide for instructions on how to do this.
- 2 To use your NBG as an access point, switch the physical button which placed at the bottom of the NBG to the middle place.

Note: You have to log in to the Web Configurator again when you change modes. As soon as you do, your NBG is already in Access Point mode.

- 3 The Web Configurator refreshes once the change to Access Point mode is successful.

8.3.2 Accessing the Web Configurator in Access Point Mode

Log in to the Web Configurator in Access Point mode, do the following:

- 1 Connect your computer to the LAN port of the NBG.
- 2 The default IP address of the NBG is "192.168.1.2". In this case, your computer must have an IP address in the range between "192.168.1.3" and "192.168.1.254".
- 3 Click **Start > Run** on your computer in Windows. Type "cmd" in the dialog box. Enter "ipconfig" to show your computer's IP address. If your computer's IP address is not in the correct range then see [Appendix B on page 184](#) for information on changing your computer's IP address.
- 4 After you've set your computer's IP address, open a web browser such as Internet Explorer and type "192.168.1.2" as the web address in your web browser.

Note: After clicking Login, the Easy mode appears. Refer to [page 37](#) for the Easy mode screens. Change to Expert mode to see the screens described in the sections following this.

8.3.3 Configuring your WLAN, Bandwidth Management and Maintenance Settings

The configuration of wireless, bandwidth management and maintenance settings in **Access Point** mode is the same as for **Router Mode**.

- See [Chapter 11 on page 80](#) for information on the configuring your wireless network.
- See [Chapter 21 on page 136](#) for information on configuring your Bandwidth Management screen.
- See [Chapter 25 on page 160](#) to [Chapter 25 on page 160](#) for information on configuring your Maintenance settings.

8.4 AP Mode Status Screen

Click  to open the **Status** screen.

Figure 43 Status Screen: Access Point Mode

The screenshot shows the 'Status' page with a 'Refresh Interval' dropdown set to 'None' and a 'Refresh Now' button. The main content is divided into several sections:

- Device Information:** Host Name: NBG6515, Firmware Version: V1.00(AAXS.0)B7, Sys OP Mode: AP Mode.
- LAN Information:** - MAC Address: EC:43:F6:73:49:16, - IP Address: 192.168.1.2, - IP Subnet Mask: 255.255.255.0, - DHCP: None.
- WLAN 2.4G Information:** - MAC Address: EC:43:F6:73:49:16, - SSID: ZyXEL734916, - Channel: Channel-11 2462MHz -(Auto Channel), - Security: WPA2-PSK.
- WLAN 5G Information:** - MAC Address: EC:43:F6:73:49:17, - SSID: ZyXEL734917.speed, - Channel: Channel-36 5180MHz -(Auto Channel), - Security: WPA2-PSK.
- System Status:** System Up Time: 00d:00h:01m:53s, Current Date/Time: 1970-01-01 / 00:01:51, System Resource: - CPU Usage: 3%, - Memory Usage: 48%, System Setting: - Configuration Mode: Expert.
- Interface Status:**

Interface	Status	Rate
WLAN 2.4G	Up	300M
WLAN 5G	Up	433M
- Summary:** Packet Statistics ([Details...](#)), WLAN Station Status ([Details...](#)).

The following table describes the labels shown in the **Status** screen.

Table 28 Status Screen: Access Point Mode

LABEL	DESCRIPTION
Logout	Click this at any time to exit the Web Configurator.
Device Information	
Host Name	This is the System Name you enter in the Maintenance > General screen. It is for identification purposes.
Firmware Version	This is the firmware version and the date created.
Sys OP Mode	This is the device mode (Section 5.1.2 on page 36) to which the NBG is set - Access Point Mode .
LAN Information	
- MAC Address	This shows the LAN Ethernet adapter MAC Address of your device.
- IP Address	This shows the LAN port's IP address.
- IP Subnet Mask	This shows the LAN port's subnet mask.
- DHCP	This shows the LAN port's DHCP role - Server, Client or None .
WLAN 2.4G Information	
- MAC Address	This shows the wireless adapter MAC Address of your device.
- SSID	This shows a descriptive name used to identify the NBG in the wireless 2.4G LAN.
- Channel	This shows the channel number which you select manually.

Table 28 Status Screen: Access Point Mode (continued)

LABEL	DESCRIPTION
- Security	This shows the level of wireless security the NBG is using.
WLAN 5G Information	
- MAC Address	This shows the wireless adapter MAC Address of your device.
- SSID	This shows a descriptive name used to identify the NBG in the wireless 5G LAN.
- Channel	This shows the channel number which you select manually.
- Security	This shows the level of wireless security the NBG is using.
System Status	
Item	This column shows the type of data the NBG is recording.
Data	This column shows the actual data recorded by the NBG.
System Up Time	This is the total time the NBG has been on.
Current Date/Time	This field displays your NBG's present date and time.
System Resource	
- CPU Usage	This displays what percentage of the NBG's processing ability is currently used. When this percentage is close to 100%, the NBG is running at full load, and the throughput is not going to improve anymore. If you want some applications to have more throughput, you should turn off other applications (for example, using bandwidth management).
- Memory Usage	This shows what percentage of the heap memory the NBG is using.
System Setting	
- Configuration Mode	This shows the web configurator mode you are viewing - Expert .
Interface Status	
Interface	This displays the NBG port types. The port types are: LAN , WLAN 2.4G , and WLAN 5G .
Status	For the LAN and WAN ports, this field displays Down (line is down) or Up (line is up or connected). For the WLAN, it displays Up when the WLAN is enabled or Down when the WLAN is disabled.
Rate	For the LAN ports, this displays the port speed and duplex setting or N/A when the line is disconnected. For the WAN port, it displays the port speed and duplex setting if you're using Ethernet encapsulation and Idle (line (ppp) idle), Dial (starting to trigger a call) and Drop (dropping a call) if you're using PPPoE or PPTP encapsulation. This field displays N/A when the line is disconnected. For the WLAN, it displays the maximum transmission rate when the WLAN is enabled and N/A when the WLAN is disabled.
Summary	
Packet Statistics	Click Details... to go to the Monitor > Packet Statistics screen (Section 4.5 on page 33). Use this screen to view port status and packet specific statistics.
WLAN Station Status	Click Details... to go to the Monitor > WLAN 2.4G / 5G Station Status screen (Section 4.7 on page 35). Use this screen to view the wireless stations that are currently associated to the NBG.

8.4.0.1 Navigation Panel

Use the menu in the navigation panel to configure NBG features in Access Point mode.

The following screen and table show the features you can configure in Access Point mode.

Figure 44 Menu: Access Point Mode



Refer to [Table 27 on page 53](#) for descriptions of the labels shown in the **Navigation** panel.

8.5 LAN Screen

Use this section to configure your LAN settings while in **Access Point** mode.

Click **Network** > **LAN** to see the screen below.

Note: If you change the IP address of the NBG in the screen below, you will need to log into the NBG again using the new IP address.

Figure 45 Network > LAN > IP

 The screenshot shows the 'IP' configuration page. At the top, there is a tab labeled 'IP'. Below it, the 'LAN TCP/IP' section has two radio buttons: 'Get from DHCP Server' (unselected) and 'Use Defined LAN IP Address' (selected). Under 'Use Defined LAN IP Address', there are three input fields: 'IP Address' with the value '192.168.1.2', 'IP Subnet Mask' with the value '255.255.255.0', and 'Default Gateway' which is empty. Below this is the 'DNS Assignment' section with two rows: 'First DNS Server' and 'Second DNS Server'. Each row has a dropdown menu set to 'From ISP' and an adjacent empty input field. At the bottom of the page are 'Apply' and 'Reset' buttons.

The table below describes the labels in the screen.

Table 29 Network > LAN > IP

LABEL	DESCRIPTION
Get from DHCP Server	<p>Click this to deploy the NBG as an access point in the network.</p> <p>When you enable this, the NBG gets its IP address from the network's DHCP server (for example, your ISP). Users connected to the NBG can now access the network (i.e., the Internet if the IP address is given by the ISP).</p> <p>The Web Configurator may no longer be accessible unless you know the IP address assigned by the DHCP server to the NBG. You need to reset the NBG to be able to access the Web Configurator again (see Section 25.7 on page 164 for details on how to reset the NBG).</p> <p>Also when you select this, you cannot enter an IP address for your NBG in the field below.</p>
Use Defined LAN IP Address	Click this if you want to specify the IP address of your NBG. Or if your ISP or network administrator gave you a static IP address to access the network or the Internet.
IP Address	Type the IP address in dotted decimal notation. The default setting is 192.168.1.2. If you change the IP address you will have to log in again with the new IP address.
IP Subnet Mask	The subnet mask specifies the network number portion of an IP address. Your NBG will automatically calculate the subnet mask based on the IP address that you assign. Unless you are implementing subnetting, use the subnet mask computed by the NBG.
Default Gateway	Enter a Default Gateway IP Address (if your ISP or network administrator gave you one) in this field.
DNS Assignment	
First DNS Server Second DNS Server	<p>Select From ISP if your ISP dynamically assigns DNS server information (and the NBG's WAN IP address). The field to the right displays the (read-only) DNS server IP address that the ISP assigns.</p> <p>Select User-Defined if you have the IP address of a DNS server. Enter the DNS server's IP address in the field to the right. If you chose User-Defined, but leave the IP address set to 0.0.0.0, User-Defined changes to None after you click Apply. If you set a second choice to User-Defined, and enter the same IP address, the second User-Defined changes to None after you click Apply.</p> <p>Select None if you do not want to configure DNS servers. If you do not configure a DNS server, you must know the IP address of a computer in order to access it.</p>
Apply	Click Apply to save your changes to the NBG.
Reset	Click Reset to reload the previous configuration for this screen.

Universal Repeater Mode

9.1 Overview

In universal repeater mode, your NBG can act as an access point and wireless client at the same time. The NBG can connect to an existing network through another access point and also lets wireless clients connect to the network through it. This helps you expand wireless coverage when you have an access point or wireless router already in your network.

In the example below, the NBG (A) is configured as a universal repeater. It has three clients that want to connect to the Internet. The NBG wirelessly connects to the available access point (B).

Figure 46 Universal Repeater Mode

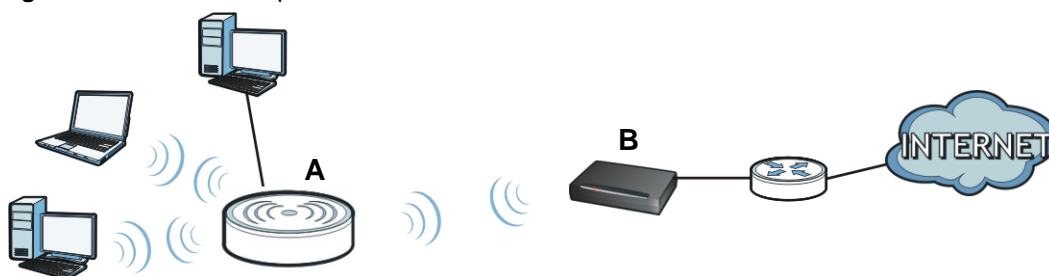

After the NBG and the access point connect, the NBG acquires its IP address from the access point. The clients of the NBG can now surf the Internet.

9.2 What You Can Do

- Use the **Status** screen to view read-only information about your NBG ([Section 9.5 on page 64](#)).
- Use the **AP Select** screen to choose an access point that you want the NBG to connect to. You should know the security settings of the target AP ([Section 9.6 on page 67](#)).
- Use other **Wireless LAN** screens to configure the wireless settings and wireless security between the wireless clients and the NBG.
- Use the **LAN** screen to set the IP address for your NBG acting as an access point ([Section 8.5 on page 60](#)).

9.3 What You Need to Know

With the exception of the **Network > Wireless LAN 2.4G/5G > AP Select** screens, other configuration screens in **Universal Repeater Mode** are similar to the ones in **Access Point Mode**.

See [Chapter 11 on page 80](#) through switching the physical button which placed at the bottom of the NBG of this User's Guide.

9.4 Setting your NBG to Universal Repeater Mode

- 1 Connect your computer to the LAN port of the NBG.
- 2 The default IP address of the NBG is "192.168.1.2". In this case, your computer must have an IP address in the range between "192.168.1.3" and "192.168.1.254".
- 3 Click **Start > Run** on your computer in Windows. Type "cmd" in the dialog box. Enter "ipconfig" to show your computer's IP address. If your computer's IP address is not in the correct range then see [Appendix B on page 184](#) for information on changing your computer's IP address.
- 4 After you've set your computer's IP address, open a web browser such as Internet Explorer and type "http://192.168.1.2" as the web address in your web browser.
- 5 Enter "1234" (default) as the password and click **Login**.
- 6 Type a new password and retype it to confirm, then click **Apply**. Otherwise, click **Ignore**.
- 7 The Easy mode appears. Click **Expert Mode** in the navigation panel.
- 8 To set your NBG to **Universal Repeater Mode**, switch the physical button which placed at the bottom of the NBG to the right side.
- 9 You have to log in to the Web Configurator again when you change modes. As soon as you do, your NBG is already in Universal Repeater mode.

The Web Configurator refreshes once the change to Universal Repeater mode is successful.

9.5 Universal Repeater Mode Status Screen

Click  to open the status screen.

Figure 47 Status: Universal Repeater Mode



The following table describes the labels shown in the **Status** screen.

Table 30 Status Screen: Universal Repeater Mode

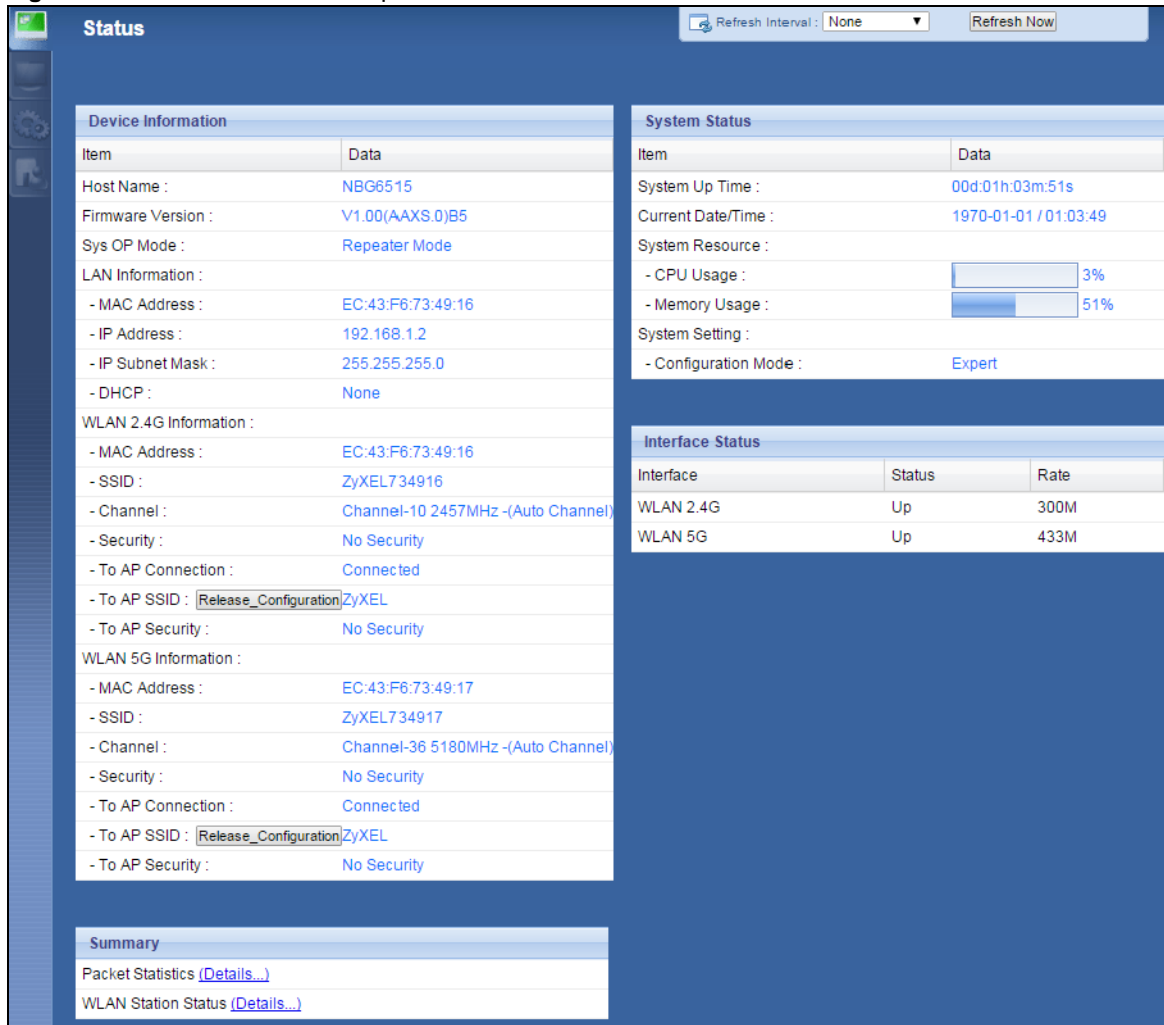
LABEL	DESCRIPTION
Device Information	
Host Name	This is the System Name you enter in the Maintenance > General screen. It is for identification purposes.
Firmware Version	This is the firmware version and the date created.
Sys OP Mode	This is the device mode (Section 5.1.2 on page 36) to which the NBG is set - Universal Repeater Mode .
LAN Information	
- MAC Address	This shows the LAN Ethernet adapter MAC Address of your device.
- IP Address	This shows the LAN port's IP address.
- IP Subnet Mask	This shows the LAN port's subnet mask.
- DHCP	This shows the LAN port's DHCP role - Client or None .
WLAN 2.4G Information	
- MAC Address	This shows the wireless adapter MAC Address of your device.

Table 30 Status Screen: Universal Repeater Mode (continued)

LABEL	DESCRIPTION
- SSID	This shows a descriptive name used to identify the NBG in the wireless LAN.
- Channel	This shows the channel number which you select manually.
- Security	This shows the level of wireless security the NBG is using.
- To AP Connection	This shows the WLAN station status. If the NBG has successfully connected to an AP or wireless router, it displays Connected . Otherwise, it displays Disconnected .
- To AP SSID	This shows the SSID of the AP or wireless router.
Release_Configuration	This button is only available when the NBG has successfully connected to an AP or wireless router. Click this button to remove all configured wireless connections and wireless security settings on the NBG.
- To AP Security	This shows the security mode of the AP or wireless router is using.
WLAN 5G Information	
- MAC Address	This shows the wireless adapter MAC Address of your device.
- SSID	This shows a descriptive name used to identify the NBG in the wireless LAN.
- Channel	This shows the channel number which you select manually.
- Security	This shows the level of wireless security the NBG is using.
- To AP Connection	This shows the WLAN station status. If the NBG has successfully connected to an AP or wireless router, it displays Connected . Otherwise, it displays Disconnected .
- To AP SSID	This shows the SSID of the AP or wireless router.
Release_Configuration	This button is only available when the NBG has successfully connected to an AP or wireless router. Click this button to remove all configured wireless connections and wireless security settings on the NBG.
- To AP Security	This shows the security mode of the AP or wireless router is using.
Summary	
Packet Statistics	Click Details... to go to the Monitor > Packet Statistics screen (Section 4.5 on page 33). Use this screen to view port status and packet specific statistics.
WLAN Station Status	Click Details... to go to the Monitor > WLAN Station Status screen (Section 4.7 on page 35). Use this screen to view the wireless stations that are currently associated to the NBG.
System Status	
Item	This column shows the type of data the NBG is recording.
Data	This column shows the actual data recorded by the NBG.
System Up Time	This is the total time the NBG has been on.
Current Date/Time	This field displays your NBG's present date and time.
System Resource	
- CPU Usage	This displays what percentage of the NBG's processing ability is currently used. When this percentage is close to 100%, the NBG is running at full load, and the throughput is not going to improve anymore. If you want some applications to have more throughput, you should turn off other applications (for example, using bandwidth management).
- Memory Usage	This shows what percentage of the heap memory the NBG is using.
System Setting	
- Configuration Mode	This shows the web configurator mode you are viewing - Expert .
Interface Status	
Interface	This displays the NBG port types. The port types are: LAN and WLAN .

Table 30 Status Screen: Universal Repeater Mode (continued)

LABEL	DESCRIPTION
Status	For the LAN ports, this field displays Down (line is down) or Up (line is up or connected). For the WLAN, it displays Up when the WLAN is enabled or Down when the WLAN is disabled.
Rate	For the LAN ports, this displays the port speed or N/A when the line is disconnected. For the WLAN, it displays the maximum transmission rate when the WLAN is enabled and N/A when the WLAN is disabled.

9.5.1 Navigation Panel

Use the menu in the navigation panel to configure NBG features in **Universal Repeater Mode**.

Figure 48 Menu: Universal Repeater Mode

Refer to [Table 27 on page 53](#) for descriptions of the labels shown in the navigation panel.

9.6 AP Select Screen

9.6.1 Wireless LAN 2.4G

Use this screen to choose an access point that you want the NBG to connect to. You should know the security settings of the target AP.

To open this screen, click **Network > Wireless LAN 2.4G > AP Select** tab.

Figure 49 Network > Wireless LAN 2.4G > AP Select

NO.	Select	SSID	MAC	Channel	Mode	Security Mode	Strength	RSSI
1	<input type="radio"/>	AD_test	B0:B2:DC:6A:9F:2C	6	6Gn	WPA2/TKIPAES	55%	-68 dbm
2	<input type="radio"/>	ZyXEL	00:13:49:00:00:07	6	6Gn	No Security	50%	-70 dbm
3	<input type="radio"/>	DHBU_WiFi	88:1F:A1:36:9B:20	11	6Gn	WPA2-PSK	44%	-72 dbm
4	<input type="radio"/>	NBG6816_Test	A0:E4:CB:41:79:8C	5	6Gn	WPA2-PSK	34%	-76 dbm
5	<input type="radio"/>	test_VID_10	4C:9E:FF:90:B0:59	6	6Gn	WPA2-PSK	34%	-76 dbm
6	<input type="radio"/>	test_VID_20	4E:90:FF:90:B0:59	6	6Gn	WPA2-PSK	34%	-76 dbm
7	<input type="radio"/>	test_VID_30	4E:91:FF:90:B0:59	6	6Gn	WPA2-PSK	34%	-76 dbm
8	<input type="radio"/>	4.1_test	00:11:22:AA:BB:CD	6	6Gn	No Security	29%	-78 dbm
9	<input type="radio"/>	test_VID_40	4E:92:FF:90:B0:59	6	6Gn	WPA2-PSK	29%	-78 dbm
10	<input type="radio"/>	SVD_Evo_24G	5C:F4:AB:A9:7B:D8	6	6Gn	WPA2-MIXED	29%	-78 dbm

Setup repeater manually
 SSID:

The following table describes the labels in this screen.

Table 31 Network > Wireless LAN 2.4G > AP Select

LABEL	DESCRIPTION
NO.	This is the index number of the APs.
Select	Use the radio button to select the wireless device to which you want to connect.
SSID	This displays the Service Set IDentity of the wireless device. The SSID is a unique name that identifies a wireless network. All devices in a wireless network must use the same SSID.
MAC	This displays the MAC address of the wireless device.
Channel	This displays the channel number used by this wireless device.
Mode	This displays which IEEE 802.11b/g/n wireless networking standards the wireless device supports.
Security Mode	This displays the type of security configured on the wireless device. When No Security is shown, no security is configured and you can connect to it without a password.
Strength	This displays the strength of the wireless signal. The signal strength mainly depends on the antenna output power and the distance between your NBG and this device.
RSSI	This shows the received signal strength indicator (RSSI), that is, the received signal strength in dBm.
Setup repeater manually	Select this to setup the AP manually.
SSID	If Setup repeater manually is selected, use this field to type the SSID of the AP. This is useful when the AP's SSID is hidden.
WPS	Click WPS to start WPS-aware wireless station scanning and the wireless security information synchronization.
Refresh	Click this to search for available wireless devices within transmission range and update this table.
Next	Click this to continue.

After you selected one of APs and click the **Next** button, the screen will display as below.

Figure 50 Network > Wireless LAN 2.4G > AP Select: Connecting Success

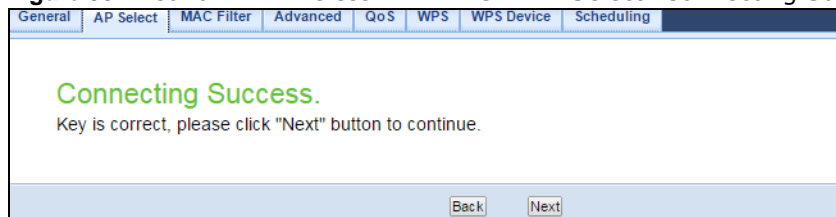

The following table describes the labels in this screen.

Table 32 Network > Wireless LAN 2.4G > AP Select: Connecting Success

LABEL	DESCRIPTION
Back	Click this to return to the previous screen.
Next	Click this to continue.

Figure 51 Network > Wireless LAN 2.4G > AP Select: Root AP SSID

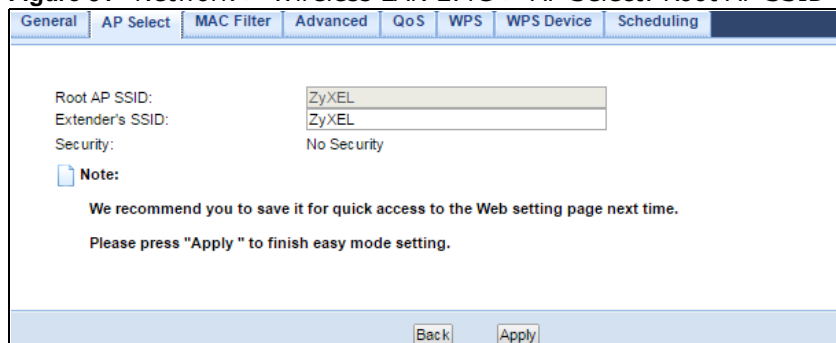

The following table describes the labels in this screen.

Table 33 Network > Wireless LAN 2.4G > AP Select: Root AP SSID

LABEL	DESCRIPTION
Root AP SSID	This field displays the specific AP's SSID which you used through the NBG.
Extender's SSID	This field displays the SSID of the NBG as an extender.
Security	This field displays the specific AP's security mode which you used through the NBG.
Back	Click this to return to the previous screen.
Apply	Click Apply to save your changes to the NBG.

9.6.2 Wireless LAN 5G

Use this screen to choose an access point that you want the NBG to connect to. You should know the security settings of the target AP.

To open this screen, click **Network > Wireless LAN 5G > AP Select** tab.

Figure 52 Network > Wireless LAN 5G > AP Select

NO.	Select	SSID	MAC	Channel	Mode	Security Mode	Strength	RSSI
1	<input type="radio"/>	ZyXEL	00:13:49:00:00:08	36	802.11n	No Security	37%	-75 dbm
2	<input type="radio"/>	DHBU_WiFi 5 GHz	88:1F:A1:36:9B:21	149	802.11n	WPA2-PSK	26%	-79 dbm
3	<input type="radio"/>	6503-5G-PPPoE	FC:F5:28:FE:3B:8C	149	802.11n	WPA2-PSK	24%	-80 dbm
4	<input type="radio"/>	4.1_test	00:11:22:AA:BB:CE	36	802.11n	No Security	10%	-86 dbm
5	<input type="radio"/>	5805-1	10:7B:EF:FE:5D:FC	149	802.11n	WPA2-PSK	10%	-86 dbm
6	<input type="radio"/>	Mark_NXC2500	4C:9E:FF:90:B0:5A	149	802.11n	WPA2-PSK	7%	-87 dbm
7	<input type="radio"/>	EVENT	50:67:F0:38:C7:88	40	802.11n	No Security	5%	-88 dbm
8	<input type="radio"/>	ZyXEL_CSO	B0:B2:DC:6A:9F:06	48	802.11n	WPA2-PSK	2%	-89 dbm
9	<input type="radio"/>	VT_SB_test_5G	5C:F4:AB:AB:59:05	36	802.11n	WPA2-PSK	1%	-90 dbm
10	<input type="radio"/>	Mark_NXC2500	A0:E4:CB:7C:FA:76	149	802.11n	WPA2-PSK	1%	-90 dbm

Setup repeater manually
 SSID:

The following table describes the labels in this screen.

Table 34 Network > Wireless LAN 5G > AP Select

LABEL	DESCRIPTION
NO.	This is the index number of the APs.
Select	Use the radio button to select the wireless device to which you want to connect.
SSID	This displays the Service Set IDentity of the wireless device. The SSID is a unique name that identifies a wireless network. All devices in a wireless network must use the same SSID.
MAC	This displays the MAC address of the wireless device.
Channel	This displays the channel number used by this wireless device.
Mode	This displays which IEEE 802.11b/g/n wireless networking standards the wireless device supports.
Security Mode	This displays the type of security configured on the wireless device. When No Security is shown, no security is configured and you can connect to it without a password.
Strength	This displays the strength of the wireless signal. The signal strength mainly depends on the antenna output power and the distance between your NBG and this device.
RSSI	This shows the received signal strength indicator (RSSI), that is, the received signal strength in dBm.
Setup repeater manually	Select this to setup the AP manually.
SSID	If Setup repeater manually is selected, use this field to type the SSID of the AP. This is useful when the AP's SSID is hidden.
WPS	Click WPS to start WPS-aware wireless station scanning and the wireless security information synchronization.
Refresh	Click this to search for available wireless devices within transmission range and update this table.
Next	Click this to continue.

After you selected one of APs and click the **Next** button, the screen will display as below.

Figure 53 Network > Wireless LAN 5G > AP Select: Connecting Success

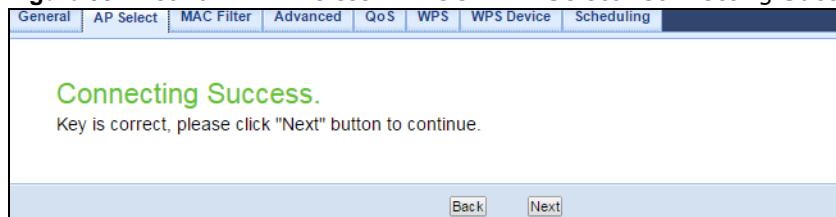

The following table describes the labels in this screen.

Table 35 Network > Wireless LAN 5G > AP Select: Connecting Success

LABEL	DESCRIPTION
Back	Click this to return to the previous screen.
Next	Click this to continue.

Figure 54 Network > Wireless LAN 5G > AP Select: Root AP SSID

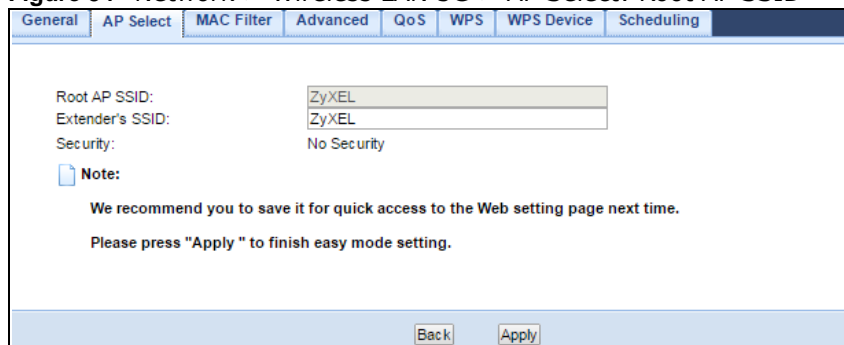

The following table describes the labels in this screen.

Table 36 Network > Wireless LAN 5G > AP Select: Root AP SSID

LABEL	DESCRIPTION
Root AP SSID	This field displays the specific AP's SSID which you used through the NBG.
Extender's SSID	This field displays the SSID of the NBG as an extender.
Security	This field displays the specific AP's security mode which you used through the NBG.
Back	Click this to return to the previous screen.
Apply	Click Apply to save your changes to the NBG.

10.1 Overview

This chapter provides tutorials for your NBG as follows:

- [Connecting to the Internet from an Access Point](#)
- [Configuring Wireless Security Using WPS](#)
- [Enabling and Configuring Wireless Security \(No WPS\)](#)
- If your connection is successful, open your Internet browser and enter <http://www.zyxel.com> or the URL of any other web site in the address bar. If you are able to access the web site, your wireless connection is successfully configured.

10.2 Connecting to the Internet from an Access Point

This section gives you an example of how to set up an access point (**AP**) and wireless client (a notebook (**B**), in this example) for wireless communication. **B** can access the Internet through the access point wirelessly.

Figure 55 Wireless Access Point Connection to the Internet

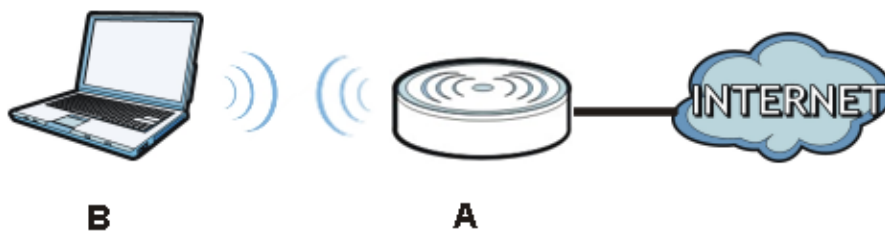

10.3 Configuring Wireless Security Using WPS

This section gives you an example of how to set up wireless network using WPS. This example uses the NBG as the AP and NWD210N as the wireless client which connects to a notebook.

Note: The wireless client must be a WPS-aware device (for example, a WPS USB adapter or PCI card).

There are two WPS methods for creating a secure connection. This tutorial shows you how to do both.

- **Push Button Configuration (PBC)** - create a secure wireless network simply by pressing a button. See [Section 10.3.1 on page 73](#). This is the easier method.
- **PIN Configuration** - create a secure wireless network simply by entering a wireless client's PIN (Personal Identification Number) in the NBG's interface. See [Section 10.3.2 on page 74](#). This is the more secure method, since one device can authenticate the other.

10.3.1 Push Button Configuration (PBC)

- 1 Make sure that your NBG is turned on and that it is within range of your computer.
- 2 Make sure that you have installed the wireless client (this example uses the NWD210N) driver and utility in your notebook.
- 3 In the wireless client utility, find the WPS settings. Enable WPS and press the WPS button (**Start** or **WPS** button)
- 4 Log into NBG's Web Configurator and press the **Push Button** button in the **Network > Wireless LAN 2.4G** or **Wireless LAN 5G > WPS Device** screen.

Note: Your NBG has a WPS button located on its panel, as well as a WPS button in its configuration utility. Both buttons have exactly the same function; you can use one or the other.

Note: It doesn't matter which button is pressed first. You must press the second button within two minutes of pressing the first one.

The NBG sends the proper configuration settings to the wireless client. This may take up to two minutes. Then the wireless client is able to communicate with the NBG securely.

The following figure shows you an example to set up wireless network and security by pressing a button on both NBG and wireless client (the NWD210N in this example).

Figure 56 Example WPS Process: PBC Method

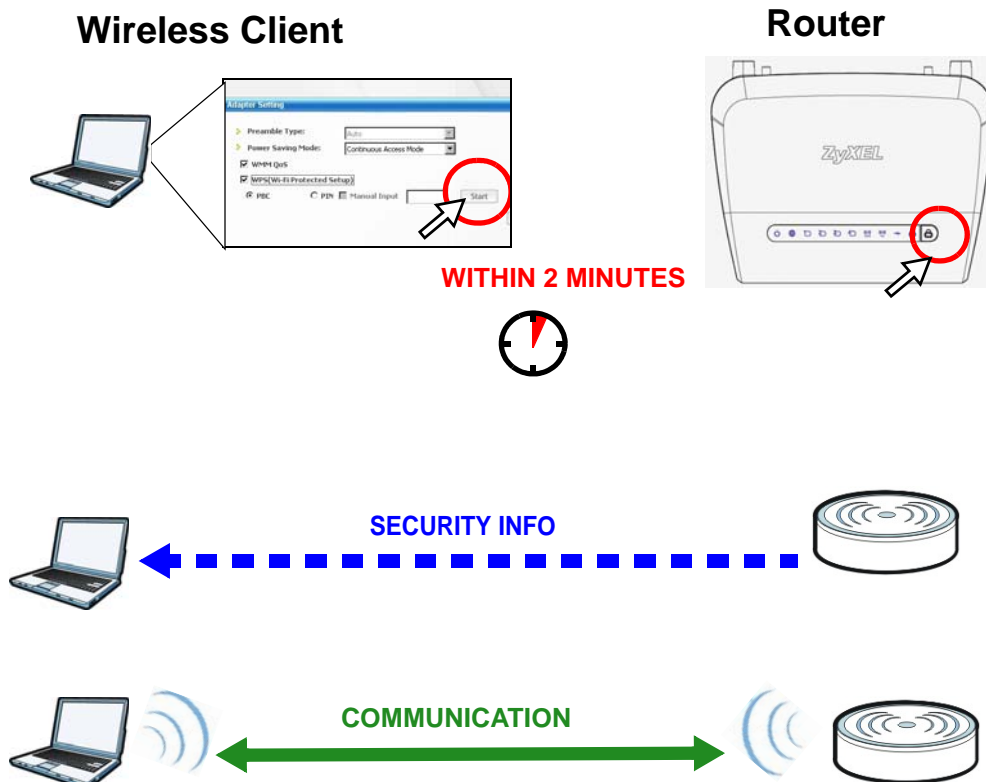

10.3.2 PIN Configuration

When you use the PIN configuration method, you need to use both NBG's configuration interface and the client's utilities.

- 1 Launch your wireless client's configuration utility. Go to the WPS settings and select the PIN method to get a PIN number.
- 2 Enter the PIN number to the **PIN** field in the **Network > Wireless LAN 2.4G** or **Wireless LAN 5G > WPS Device** screen on the NBG.
- 3 Click **Start** button (or button next to the PIN field) on both the wireless client utility screen and the NBG's **WPS Device** screen within two minutes.

The NBG authenticates the wireless client and sends the proper configuration settings to the wireless client. This may take up to two minutes. Then the wireless client is able to communicate with the NBG securely.

The following figure shows you the example to set up wireless network and security on NBG and wireless client (ex. NWD210N in this example) by using PIN method.

Figure 57 Example WPS Process: PIN Method

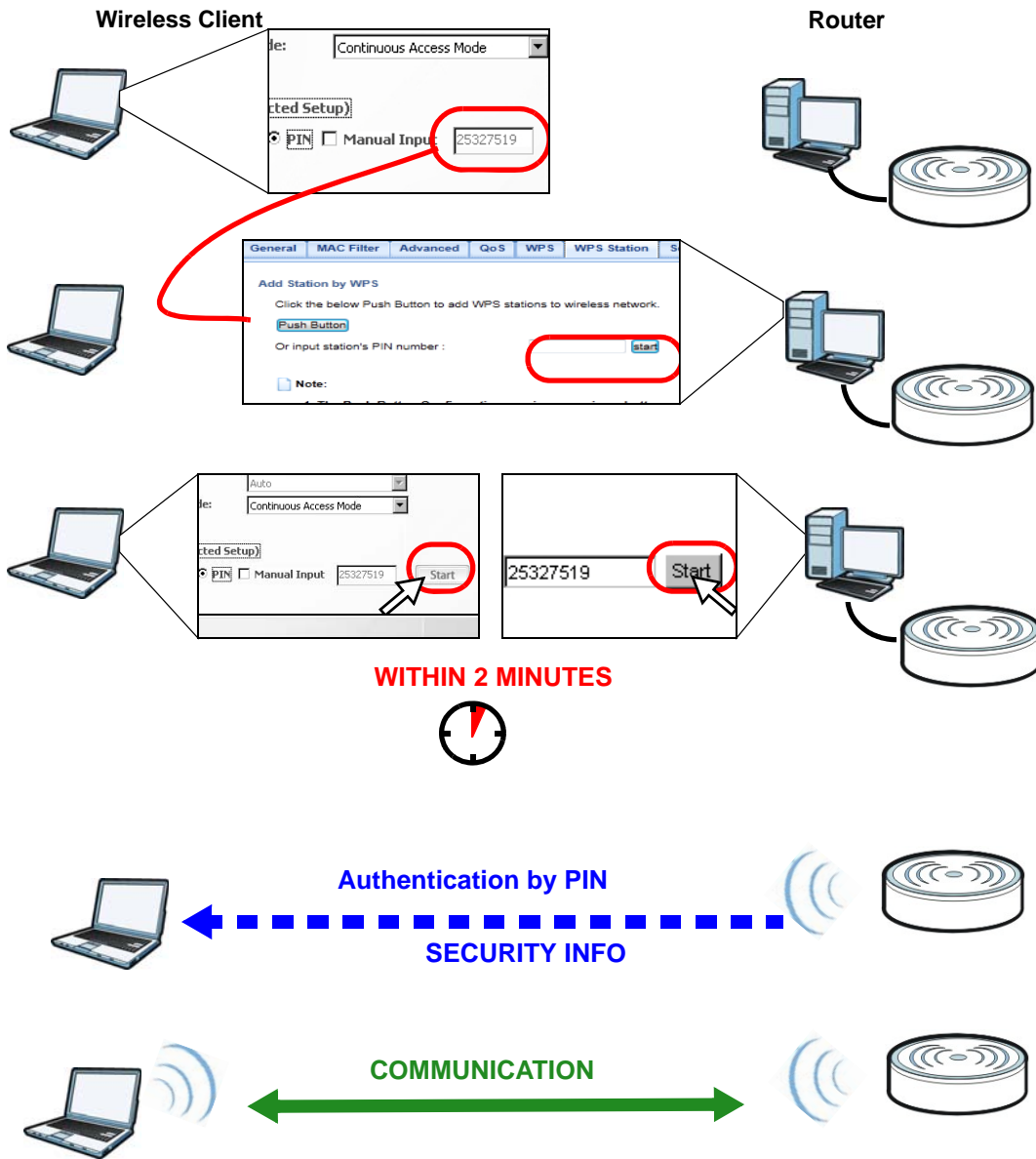

10.4 Enabling and Configuring Wireless Security (No WPS)

This example shows you how to configure wireless security settings with the following parameters on your NBG.

SSID	SSID_Example3
Channel	6
Security	WPA-PSK (Pre-Shared Key: ThisismyWPA-PSKpre-sharedkey)

Follow the steps below to configure the wireless settings on your NBG.

The instructions require that your hardware is connected (see the Quick Start Guide) and you are logged into the Web Configurator through your LAN connection (see [Section 3.2 on page 26](#)).

- 1 Open the **Wireless LAN 2.4G/5G > General** screen in the AP's Web Configurator.
- 2 Enable **Wireless LAN**.
- 3 Enter **SSID_Example3** as the SSID and select a channel. Set security mode to **WPA-PSK** and enter **ThisismyWPA-PSKpre-sharedkey** in the **Pre-Shared Key** field. Click **Apply**.

Figure 58 Tutorial: Network > Wireless LAN 2.4G/5G > General

The screenshot shows the 'Wireless Setup' section of the Web Configurator. Under 'Wireless LAN', the 'Enable' radio button is selected. The 'Network Name (SSID)' field is filled with 'SSID_Example3'. Under 'Security', the 'Security Mode' is set to 'WPA-PSK' and the 'Pre-Shared Key' field contains 'ThisismyWPA-PSKpre-sharedkey'. A note at the bottom indicates that WPA2-PSK cannot be configured when WPS is enabled. The 'Apply' and 'Reset' buttons are at the bottom of the page.

- 4 Open the **Status** screen. Verify your wireless and wireless security settings under **Device Information** and check if the WLAN connection is up under **Interface Status**.

Figure 59 Tutorial: Checking Wireless Settings

The screenshot displays the ZyXEL wireless utility interface. It is divided into several sections:

- WLAN 2.4G Information:**
 - MAC Address : EC:43:F6:73:49:16
 - SSID : ZyXEL734916
 - Channel : Channel-11 2462MHz -(Auto Channel)
 - Security : WPA2-PSK
- WLAN 5G Information:**
 - MAC Address : EC:43:F6:73:49:17
 - SSID : ZyXEL734917.speed
 - Channel : Channel-36 5180MHz -(Auto Channel)
 - Security : WPA2-PSK
- Interface Status:**

Interface	Status
WAN	Down
LAN1	Down
LAN2	Down
LAN3	Up
LAN4	Down
WLAN 2.4G	Up
WLAN 5G	Up
- Summary:**
 - DHCP Table ([Details...](#))
 - Packet Statistics ([Details...](#))
 - WLAN Station Status ([Details...](#))

10.4.1 Configure Your Notebook

Note: We use the ZyXEL M-302 wireless adapter utility screens as an example for the wireless client. The screens may vary for different models.

- 1 The NBG supports IEEE 802.11b, IEEE 802.11g, IEEE 802.11n and IEEE 802.11ac wireless clients. Make sure that your notebook or computer's wireless adapter supports one of these standards.
- 2 Wireless adapters come with software sometimes called a "utility" that you install on your computer. See your wireless adapter's User's Guide for information on how to do that.
- 3 After you've installed the utility, open it. If you cannot see your utility's icon on your screen, go to **Start > Programs** and click on your utility in the list of programs that appears. The utility displays a list of APs within range, as shown in the example screen below.
- 4 Select SSID_Example3 and click **Connect**.

Figure 60 Connecting a Wireless Client to a Wireless Network t

The screenshot shows the ZyXEL wireless utility interface with the following details:

- Available Network List:**

SSID	Channel	Signal
ZyXEL_MIS	6	62%
ZyXEL_YZU	6	62%
ZyXEL_test	6	60%
SSID_Example3	6	56%
CPE_5257_00	11	54%
- Site Information:**
 - Network Type: Infrastructure
 - Network Mode: 802.11g
 - Channel: 6
 - Security: WPA-PSK
 - MAC Address: 00:A0:C5:CD:1F:64
 - Surveyed at: 11:46:38

- 5 Select WPA-PSK and type the security key in the following screen. Click **Next**.

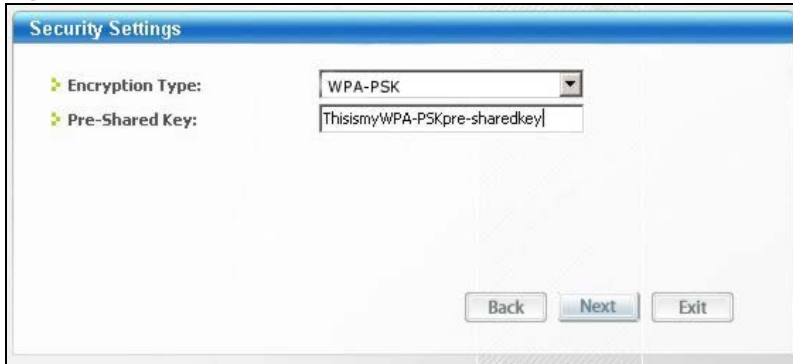
Figure 61 Security Settings

- 6 The **Confirm Save** window appears. Check your settings and click **Save** to continue.

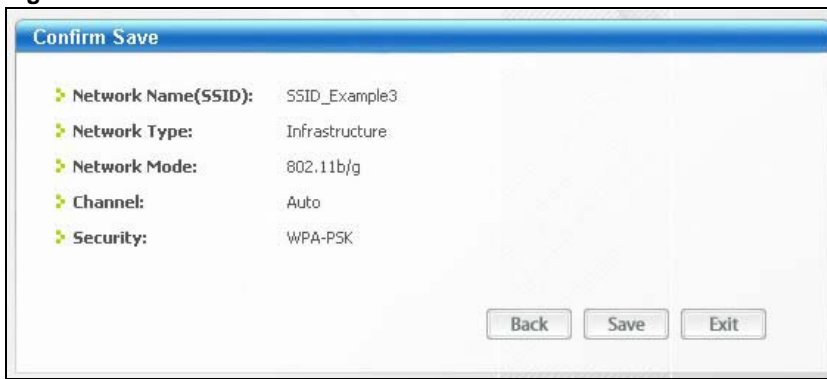
Figure 62 Confirm Save

- 7 Check the status of your wireless connection in the screen below. If your wireless connection is weak or you have no connection, see the Troubleshooting section of this User's Guide.

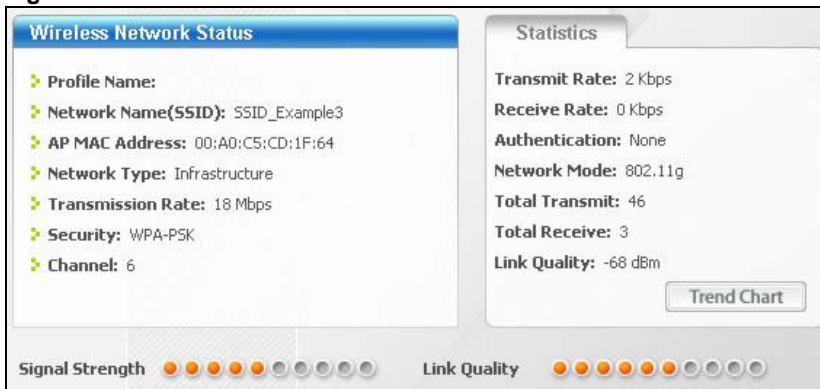
Figure 63 Link Status

If your connection is successful, open your Internet browser and enter <http://www.zyxel.com> or the URL of any other web site in the address bar. If you are able to access the web site, your wireless connection is successfully configured.

PART II

Technical Reference

Wireless LAN

11.1 Overview

This chapter discusses how to configure the wireless network settings in your NBG. See the appendices for more detailed information about wireless networks.

The following figure provides an example of a wireless network.

Figure 64 Example of a Wireless Network

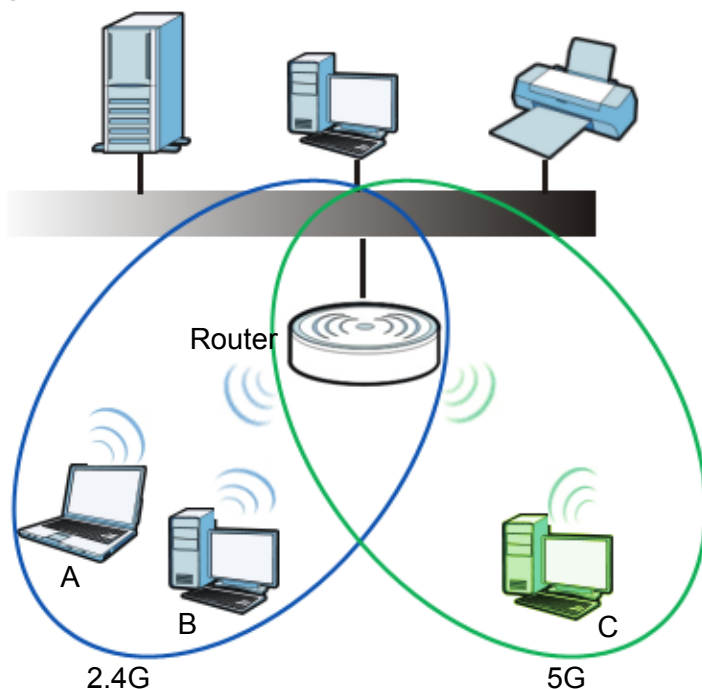

The wireless 2.4G network is the part in the blue circle and wireless 5G network is the part in the green circle. In these wireless networks, devices A, B and C are called wireless clients. The wireless clients use the access point (AP) to interact with other devices (such as the printer) or with the Internet.

11.2 What You Can Do

- Use the **General** screen ([Section 11.4 on page 83](#)) to enable the Wireless LAN, enter the SSID and select the wireless security mode.
- Use the **MAC Filter** screen ([Section 11.6 on page 89](#)) to allow or deny wireless stations based on their MAC addresses from connecting to the NBG.

- Use the **Advanced** screen ([Section 11.7 on page 90](#)) to allow wireless advanced features, such as intra-BSS networking and set the RTS/CTS Threshold.
- Use the **QoS** screen ([Section 11.8 on page 91](#)) to set priority levels to services, such as e-mail, VoIP, chat, and so on.
- Use the **WPS** screen ([Section 11.9 on page 91](#)) to quickly set up a wireless network with strong security, without having to configure security settings manually.
- Use the **WPS Device** screen ([Section 11.10 on page 92](#)) to add a wireless device using WPS.
- Use the **Scheduling** screen ([Section 11.11 on page 93](#)) to set the times your wireless LAN is turned on and off.
- Use the **Guest WLAN** screen ([Section 11.12 on page 94](#)) to configure multiple BSSs on the NBG.

11.3 What You Should Know

Every wireless network must follow these basic guidelines.

- Every wireless client in the same wireless network must use the same SSID.
The SSID is the name of the wireless network. It stands for Service Set IDentity.
- If two wireless networks overlap, they should use different channels.
Like radio stations or television channels, each wireless network uses a specific channel, or frequency, to send and receive information.
- Every wireless client in the same wireless network must use security compatible with the AP.
Security stops unauthorized devices from using the wireless network. It can also protect the information that is sent in the wireless network.

11.3.1 Wireless Security Overview

The following sections introduce different types of wireless security you can set up in the wireless network.

11.3.1.1 SSID

Normally, the AP acts like a beacon and regularly broadcasts the SSID in the area. You can hide the SSID instead, in which case the AP does not broadcast the SSID. In addition, you should change the default SSID to something that is difficult to guess.

This type of security is fairly weak, however, because there are ways for unauthorized devices to get the SSID. In addition, unauthorized devices can still see the information that is sent in the wireless network.

11.3.1.2 MAC Address Filter

Every wireless client has a unique identification number, called a MAC address.¹ A MAC address is usually written using twelve hexadecimal characters²; for example, 00A0C5000002 or

1. Some wireless devices, such as scanners, can detect wireless networks but cannot use wireless networks. These kinds of wireless devices might not have MAC addresses.

2. Hexadecimal characters are 0, 1, 2, 3, 4, 5, 6, 7, 8, 9, A, B, C, D, E, and F.

00:A0:C5:00:00:02. To get the MAC address for each wireless client, see the appropriate User's Guide or other documentation.

You can use the MAC address filter to tell the AP which wireless clients are allowed or not allowed to use the wireless network. If a wireless client is allowed to use the wireless network, it still has to have the correct settings (SSID, channel, and security). If a wireless client is not allowed to use the wireless network, it does not matter if it has the correct settings.

This type of security does not protect the information that is sent in the wireless network. Furthermore, there are ways for unauthorized devices to get the MAC address of an authorized wireless client. Then, they can use that MAC address to use the wireless network.

11.3.1.3 Encryption

Wireless networks can use encryption to protect the information that is sent in the wireless network. Encryption is like a secret code. If you do not know the secret code, you cannot understand the message.

The types of encryption you can choose depend on the type of user authentication.

Table 37 Types of Encryption for Each Type of Authentication

	NO AUTHENTICATION
Weakest	No Security
	WEP
	WPA-PSK
Strongest	WPA2-PSK

Usually, you should set up the strongest encryption that every wireless client in the wireless network supports. Suppose the wireless network has two wireless clients. Device A only supports WEP, and device B supports WEP and WPA-PSK. Therefore, you should set up **WEP** in the wireless network.

Note: It is recommended that wireless networks use **WPA-PSK** or stronger encryption. IEEE 802.1x and WEP encryption are better than none at all, but it is still possible for unauthorized devices to figure out the original information pretty quickly.

When you select **WPA2-PSK** in your NBG, you can also select an option (**WPA Compatible**) to support WPA as well. In this case, if some wireless clients support WPA and some support WPA2, you should set up **WPA2-PSK** (depending on the type of wireless network login) and select the **WPA Compatible** option in the NBG.

Many types of encryption use a key to protect the information in the wireless network. The longer the key, the stronger the encryption. Every wireless client in the wireless network must have the same key.

11.3.1.4 WPS

WiFi Protected Setup (WPS) is an industry standard specification, defined by the WiFi Alliance. WPS allows you to quickly set up a wireless network with strong security, without having to configure security settings manually. Depending on the devices in your network, you can either press a button (on the device itself, or in its configuration utility) or enter a PIN (Personal Identification Number) in the devices. Then, they connect and set up a secure network by themselves. See how to set up a secure wireless network using WPS in the [Section 10.3 on page 72](#).

11.3.1.5 WDS

Wireless Distribution System or WDS security is used between bridged APs. It is independent of the security between the wired networks and their respective APs. If you do not enable WDS security, traffic between APs is not encrypted. When WDS security is enabled, both APs must use the same pre-shared key.

11.4 General Wireless LAN 2.4G/5G General Screen

Use this screen to enable the Wireless LAN 2.4G or 5G, enter the SSID and enable Guest WLAN.

Note: If you are configuring the NBG from a computer connected to the wireless LAN and you change the NBG's SSID, channel or security settings, you will lose your wireless connection when you press **Apply** to confirm. You must then change the wireless settings of your computer to match the NBG's new settings.

This screen varies depending on whether you chose **Static WEP**, **WPA**, **WPA2**, **WPA-PSK** or **WPA2-PSK** to add security on the selected wireless network. The wireless clients which want to associate to this network must have same wireless security settings as the NBG. **No Security** allows any client to connect to this network without authentication.

If you enable the WPS function, only **No Security**, **Static WEP**, **WPA-PSK** and **WPA2-PSK** are available in this field.

Click **Network > Wireless LAN 2.4G** or **Wireless LAN 5G** to open the **General** screen.

Figure 65 Network > Wireless LAN 2.4G/5G > General

The screenshot displays the configuration interface for the Wireless LAN 2.4G/5G General settings. The interface is organized into two main sections: Wireless Setup and Security. In the Wireless Setup section, the Wireless LAN is set to 'Enable', the Network Name (SSID) is 'ZyXEL734916', and 'Hide SSID' is unchecked. The Channel Selection is 'Channel-11 2462MHz' with 'Auto Channel Selection' checked. The Operating Channel is 'Channel-11 2462MHz', the Network Mode is '2.4 GHz (802.11b/g/n)', the Channel Bandwidth is '20/40', and the Extension Channel is 'AUTO'. In the Security section, the Security Mode is 'WPA2-PSK', 'WPA Compatible' is unchecked, the Pre-Shared Key is '20F3E09F58F8D', and the Group Key Update Timer is '3600' seconds. A note at the bottom of the Security section states: 'Note: No Security and WPA2-PSK can be configured when WPS enabled'. At the bottom of the screen, there are 'Apply' and 'Reset' buttons.

The following table describes the general wireless LAN labels in this screen.

Table 38 Network > Wireless LAN 2.4G/5G > General

LABEL	DESCRIPTION
Wireless Setup	
Wireless LAN	<p>Select the radio button to Enable or Disable Wireless LAN.</p> <p>You can turn the wireless LAN on or off using the switch at the rear panel of the NBG.</p>
Network Name (SSID)	<p>(Service Set IDentity) The SSID identifies the Service Set with which a wireless station is associated. Wireless stations associating to the NBG must have the same SSID. Enter a descriptive name (up to 32 keyboard characters) for the wireless LAN.</p>
Hide SSID	<p>Select this check box to hide the SSID in the outgoing beacon frame so a station cannot obtain the SSID through scanning using a site survey tool.</p>
Channel Selection	<p>Set the operating frequency/channel depending on your particular region.</p> <p>Select a channel from the drop-down list box. The options vary depending on the frequency band and the country you are in.</p> <p>Refer to the Connection Wizard chapter for more information on channels. This option is only available if Auto Channel Selection is disabled.</p>
Operating Channel	<p>This displays the channel the NBG is currently using.</p>
Network Mode (Wireless LAN 2.4G)	<p>Select 11b/g mixed mode to allow IEEE802.11b and IEEE802.11g compliant WLAN devices to associate with the NBG.</p> <p>Select 11b only to allow only IEEE 802.11b compliant WLAN devices to associate with the NBG.</p> <p>Select 11g only to allow only IEEE 802.11g compliant WLAN devices to associate with the NBG.</p> <p>Select 11n only to allow only IEEE 802.11n compliant WLAN devices to associate with the NBG.</p> <p>Select 11b/g/n mixed mode to allow IEEE802.11b, IEEE802.11g and IEEE802.11n compliant WLAN devices to associate with the NBG.</p>
Network Mode (Wireless LAN 5G)	<p>Select 11a/n mixed mode to allow IEEE802.11a and IEEE802.11n compliant WLAN devices to associate with the NBG.</p> <p>Select 11a only to allow only IEEE 802.11a compliant WLAN devices to associate with the NBG.</p> <p>Select 11ac/a/n to allow only IEEE 802.11a, IEEE802.11an and IEEE802.11ac compliant WLAN devices to associate with the NBG.</p>
Channel Bandwidth	<p>Select the channel bandwidth you want to use for your wireless network.</p> <p>It is recommended that you select 20/40 (20, 40, 20/40 MHz).</p> <p>Select 20 MHz if you want to lessen radio interference with other wireless devices in your neighborhood.</p>
Extension Channel	<p>This is set to Auto by default.</p> <p>If you select 20/40 as your Channel Bandwidth, the extension channel enables the NBG to get higher data throughput. This also lowers radio interference and traffic.</p>
Security	

Table 38 Network > Wireless LAN 2.4G/5G > General (continued)

LABEL	DESCRIPTION
Security Mode	Select Static WEP , WPA-PSK , WPA2-PSK to add security on this wireless network. The wireless clients which want to associate to this network must have same wireless security settings as this device. After you select to use a security, additional options appears in this screen. Section 11.5 on page 85 for detailed information on different security modes. Or you can select No Security to allow any client to associate this network without authentication. Note: If the WPS function is enabled (default), only No Security and WPA2-PSK are available in this field.
Apply	Click Apply to save your changes back to the NBG.
Reset	Click Reset to begin configuring this screen afresh.

See the rest of this chapter for information on the other labels in this screen.

11.5 General Wireless LAN 2.4G/5G Security Screen

This screen varies depending on whether you chose **Static WEP**, **WPA-PSK** or **WPA2-PSK** to add security on the selected wireless network. The wireless clients which want to associate to this network must have same wireless security settings as the NBG. **No Security** allows any client to connect to this network without authentication.

11.5.1 No Security

Select **No Security** to allow wireless stations to communicate with the access points without any data encryption.

Note: If you do not enable any wireless security on your NBG, your network is accessible to any wireless networking device that is within range.

Figure 66 Network > Wireless LAN 2.4G/5G > General: No Security

The screenshot shows the configuration interface for the wireless LAN. The 'General' tab is selected. Under 'Wireless Setup', 'Wireless LAN' is enabled. The 'Network Name (SSID)' is 'ZyXEL734916'. 'Channel Selection' is set to 'Channel-11 2462MHz' with 'Auto Channel Selection' checked. 'Operating Channel' is 'Channel-11 2462MHz'. 'Network Mode' is '2.4 GHz (802.11b/g/n)'. 'Channel Bandwidth' is '20/40'. 'Extension Channel' is 'AUTO'. Under 'Security', 'Security Mode' is set to 'No Security'. A note states: 'Note: No Security and WPA2-PSK can be configured when WPS enabled'. 'Apply' and 'Reset' buttons are at the bottom.

The following table describes the labels in this screen.

Table 39 Network > Wireless LAN 2.4G/5G > General: No Security

LABEL	DESCRIPTION
Security Mode	Choose No Security from the drop-down list box.
Apply	Click Apply to save your changes back to the NBG.
Reset	Click Reset to begin configuring this screen afresh.

Refer to [Table 38 on page 84](#) for descriptions of the other labels in this screen.

11.5.2 WEP Encryption

WEP encryption scrambles the data transmitted between the wireless stations and the access points to keep network communications private. It encrypts unicast and multicast communications in a network. Both the wireless stations and the access points must use the same WEP key.

Your NBG allows you to configure up to four 64-bit or 128-bit WEP keys but only one key can be enabled at any one time.

In order to configure and enable WEP encryption, click **Network > Wireless LAN 2.4G** or **Wireless LAN 5G** to display the **General** screen. Select **Static WEP** from the **Security Mode** list.

Figure 67 Network > Wireless LAN 2.4G/5G > General: Static WEP

The following table describes the wireless LAN security labels in this screen.

Table 40 Network > Wireless LAN 2.4G/5G > General: Static WEP

LABEL	DESCRIPTION
Security Mode	Select Static WEP to enable data encryption.
PassPhrase	Enter a Passphrase (up to 26 printable characters) and click Generate. A passphrase functions like a password. In WEP security mode, it is further converted by the NBG into a complicated string that is referred to as the "key". This key is requested from all devices wishing to connect to a wireless network.
WEP Encryption	Select 64-bit WEP or 128-bit WEP . This dictates the length of the security key that the network is going to use.
Authentication Method	Select Auto or Shared Key from the drop-down list box. This field specifies whether the wireless clients have to provide the WEP key to login to the wireless client. Keep this setting at Auto unless you want to force a key verification before communication between the wireless client and the NBG occurs. Select Shared Key to force the clients to provide the WEP key prior to communication.
ASCII	Select this option in order to enter ASCII characters as WEP key.
Hex	Select this option in order to enter hexadecimal characters as a WEP key. The preceding "0x", that identifies a hexadecimal key, is entered automatically.

Table 40 Network > Wireless LAN 2.4G/5G > General: Static WEP (continued)

LABEL	DESCRIPTION
Key 1 to Key 4	The WEP keys are used to encrypt data. Both the NBG and the wireless stations must use the same WEP key for data transmission. If you chose 64-bit WEP , then enter any 5 ASCII characters or 10 hexadecimal characters ("0-9", "A-F"). If you chose 128-bit WEP , then enter 13 ASCII characters or 26 hexadecimal characters ("0-9", "A-F"). You must configure at least one key, only one key can be activated at any one time.
Apply	Click Apply to save your changes back to the NBG.
Reset	Click Reset to begin configuring this screen afresh.

Refer to [Table 38 on page 84](#) for descriptions of the other labels in this screen.

11.5.3 WPA-PSK/WPA2-PSK

Click **Network > Wireless LAN 2.4G** or **Wireless LAN 5G** to display the **General** screen. Select **WPA-PSK** or **WPA2-PSK** from the **Security Mode** list.

Figure 68 Network > Wireless LAN 2.4G/5G > General: WPA-PSK/WPA2-PSK

The screenshot shows the configuration interface for Wireless LAN. The 'Wireless Setup' section includes:

- Wireless LAN: Enable, Disable
- Network Name (SSID): ZyXEL734916
- Hide SSID:
- Channel Selection: Channel-11 2462MHz, Auto Channel Selection
- Operating Channel: Channel-11 2462MHz
- Network Mode: 2.4 GHz (802.11b/g/n)
- Channel Bandwidth: 20, 40, 20/40
- Extension Channel: AUTO

 The 'Security' section includes:

- Security Mode: WPA2-PSK
- WPA Compatible:
- Pre-Shared Key: 20F3E09F58F8D
- Group Key Update Timer: 3600 seconds

 A note at the bottom states: "Note: No Security and WPA2-PSK can be configured when WPS enabled." Buttons for 'Apply' and 'Reset' are at the bottom right.

The following table describes the labels in this screen.

Table 41 Network > Wireless LAN 2.4G/5G > General: WPA-PSK/WPA2-PSK

LABEL	DESCRIPTION
Security Mode	Select WPA-PSK or WPA2-PSK to enable data encryption.
WPA Compatible	This field appears when you choose WPA-PSK2 as the Security Mode . Check this field to allow wireless devices using WPA-PSK security mode to connect to your NBG.
Pre-Shared Key	WPA-PSK/WPA2-PSK uses a simple common password for authentication. Type a pre-shared key from 8 to 63 case-sensitive keyboard characters.

Table 41 Network > Wireless LAN 2.4G/5G > General: WPA-PSK/WPA2-PSK (continued)

LABEL	DESCRIPTION
Group Key Update Timer	The Group Key Update Timer is the rate at which the AP sends a new group key out to all clients.
Apply	Click Apply to save your changes back to the NBG.
Reset	Click Reset to begin configuring this screen afresh.

Refer to [Table 38 on page 84](#) for descriptions of the other labels in this screen.

11.6 MAC Filter

The MAC filter screen allows you to configure the NBG to give exclusive access to devices (Allow) or exclude devices from accessing the NBG (Deny). Every Ethernet device has a unique MAC (Media Access Control) address. The MAC address is assigned at the factory and consists of six pairs of hexadecimal characters, for example, 00:A0:C5:00:00:02. You need to know the MAC address of the devices to configure this screen.

To change your NBG's MAC filter settings, click **Network > Wireless LAN 2.4G** or **Wireless LAN 5G > MAC Filter**. The screen appears as shown.

Figure 69 Network > Wireless LAN 2.4G/5G > MAC Filter

The following table describes the labels in this menu.

Table 42 Network > Wireless LAN 2.4G/5G > MAC Filter

LABEL	DESCRIPTION
Access Policy	
Policy	Define the filter action for the list of MAC addresses in the MAC Address table. Select Allow to permit access to the NBG, MAC addresses not listed will be denied access to the NBG. Select Disable to block access to the NBG, MAC addresses not listed will be allowed to access the NBG
Add a station Mac Address	Enter the MAC addresses of the wireless station that are allowed or denied access to the NBG in these address fields. Enter the MAC addresses in a valid MAC address format, that is, six hexadecimal character pairs, for example, 12:34:56:78:9a:bc. Click Add .
MAC Filter Summary	
Delete	Click the delete icon to remove the MAC address from the list.

Table 42 Network > Wireless LAN 2.4G/5G > MAC Filter (continued)

LABEL	DESCRIPTION
MAC Address	This is the MAC address of the wireless station that are allowed or denied access to the NBG.
Apply	Click Apply to save your changes back to the NBG.
Reset	Click Reset to begin configuring this screen afresh.

11.7 Wireless LAN Advanced Screen

Use this screen to allow wireless advanced features, such as intra-BSS networking and set the RTS/CTS Threshold

Click **Network > Wireless LAN 2.4G** or **Wireless LAN 5G > Advanced**. The screen appears as shown.

Figure 70 Network > Wireless LAN 2.4G/5G > Advanced

The following table describes the labels in this screen.

Table 43 Network > Wireless LAN 2.4G/5G > Advanced

LABEL	DESCRIPTION
Wireless Advanced Setup	
RTS/CTS Threshold	Data with its frame size larger than this value will perform the RTS (Request To Send)/CTS (Clear To Send) handshake.
Fragmentation Threshold	The threshold (number of bytes) for the fragmentation boundary for directed messages. It is the maximum data fragment size that can be sent. Enter an even number.
Enable Intra-BSS Traffic Blocking	A Basic Service Set (BSS) exists when all communications between wireless clients or between a wireless client and a wired network client go through one access point (AP). Intra-BSS traffic is traffic between wireless clients in the BSS. When Intra-BSS is enabled, wireless client A and B can access the wired network and communicate with each other. When Intra-BSS is disabled, wireless client A and B can still access the wired network but cannot communicate with each other.
Output Power	Set the output power of the NBG in this field. If there is a high density of APs in an area, decrease the output power of the NBG to reduce interference with other APs. Select one of the following 100% , 90% , 75% , 50% , 25% , 10% or Minimum . See the product specifications for more information on your NBG's output power.
HT (High Throughput) Physical Mode - Use the fields below to configure the 802.11 wireless environment of your NBG.	

Table 43 Network > Wireless LAN 2.4G/5G > Advanced (continued)

LABEL	DESCRIPTION
Guard Interval	Select Auto to increase data throughput. However, this may make data transfer more prone to errors. Select Long to prioritize data integrity. This may be because your wireless network is busy and congested or the NBG is located in an environment prone to radio interference.
Apply	Click Apply to save your changes back to the NBG.
Reset	Click Reset to begin configuring this screen afresh.

11.8 Quality of Service (QoS) Screen

The QoS screen allows you to automatically give a service (such as VoIP and video) a priority level.

Click **Network > Wireless LAN 2.4G** or **Wireless LAN 5G > QoS**. The following screen appears.

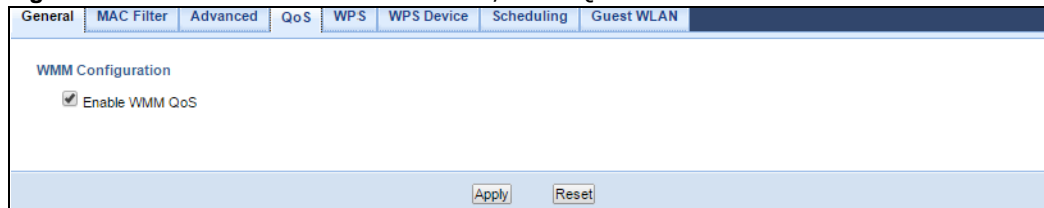
Figure 71 Network > Wireless LAN 2.4G/5G > QoS

The following table describes the labels in this screen.

Table 44 Network > Wireless LAN 2.4G/5G > QoS

LABEL	DESCRIPTION
Enable WMM QoS	Check this to have the NBG automatically give a service a priority level according to the ToS value in the IP header of packets it sends. WMM QoS (Wifi MultiMedia Quality of Service) gives high priority to voice and video, which makes them run more smoothly.
Apply	Click Apply to save your changes to the NBG.
Reset	Click Reset to begin configuring this screen afresh.

11.9 WPS Screen

Use this screen to enable/disable WPS, view or generate a new PIN number and check current WPS status. To open this screen, click **Network > Wireless LAN 2.4G** or **Wireless LAN 5G > WPS** tab.

Figure 72 Network > Wireless LAN 2.4G/5G > WPS

The following table describes the labels in this screen.

Table 45 Network > Wireless LAN 2.4G/5G > WPS

LABEL	DESCRIPTION
WPS Setup	
Enable WPS	Select this to enable the WPS feature.
Enable PIN	Select this to enable the WPS feature.
PIN Number	This displays a PIN number last time system generated. Click Generate to generate a new PIN number.
WPS Status	
Status	This displays Configured when the NBG has connected to a wireless network using WPS or when Enable WPS is selected and wireless or wireless security settings have been changed. The current wireless and wireless security settings also appear in the screen. This displays Unconfigured if WPS is disabled and there are no wireless or wireless security changes on the NBG or you click Release_Configuration to remove the configured wireless and wireless security settings.
Release Configuration	This button is only available when the WPS status displays Configured . Click this button to remove all configured wireless and wireless security settings for WPS connections on the NBG.
802.11 Mode	This is the 802.11 mode used. Only compliant WLAN devices can associate with the NBG.
SSID	This is the name of the wireless network.
Security	This is the type of wireless security employed by the network.
Apply	Click Apply to save your changes back to the NBG.
Reset	Click Reset to begin configuring this screen afresh.

11.10 WPS Device Screen

Use this screen when you want to add a wireless station using WPS. To open this screen, click **Network > Wireless LAN 2.4G** or **Wireless LAN 5G > WPS Station** tab.

Note: Note: After you click **Push Button** on this screen, you have to press a similar button in the wireless station utility within 2 minutes. To add the second wireless station, you have to press these buttons on both device and the wireless station again after the first 2 minutes.

Figure 73 Network > Wireless LAN 2.4G/5G > WPS Device

The screenshot shows the 'WPS Device' configuration page. At the top, there are navigation tabs: General, MAC Filter, Advanced, QoS, WPS, WPS Device, Scheduling, and Guest WLAN. The main content area is titled 'Add Device using WPS'. It contains the following text: 'Click WPS below to add WPS stations to your wireless network. Button to add WPS devices to wireless network.' Below this is a button labeled 'WPS'. Underneath is the text 'Or input your devices PIN number :', followed by a text input field and a 'Go' button. A 'Note' section contains two numbered instructions: '1. Using WPS requires pressing a button on both your Device and the NBG6515 within 120 seconds.' and '2. The PIN for your device is normally found within 'Settings''.

The following table describes the labels in this screen.

Table 46 Network > Wireless LAN 2.4G/5G > WPS Station

LABEL	DESCRIPTION
WPS	Use this button when you use the PBC (Push Button Configuration) method to configure wireless stations's wireless settings. See Section 10.3.1 on page 73 . Click this to start WPS-aware wireless station scanning and the wireless security information synchronization.
Or input your devices PIN number	Use this button when you use the PIN Configuration method to configure wireless station's wireless settings. See Section 10.3.2 on page 74 . Type the same PIN number generated in the wireless station's utility. Then click Go to associate to each other and perform the wireless security information synchronization.

11.11 Scheduling Screen

Use this screen to set the times your wireless LAN is turned on and off. Wireless LAN scheduling is disabled by default. The wireless LAN can be scheduled to turn on or off on certain days and at certain times. To open this screen, click **Network > Wireless LAN 2.4G** or **Wireless LAN 5G > Scheduling** tab.

Figure 74 Network > Wireless LAN 2.4G/5G > Scheduling

Wireless LAN Scheduling

Enable Wireless LAN Scheduling

WLAN status	Day	For the following times (24-Hour Format)			
<input checked="" type="radio"/> On <input type="radio"/> Off	<input checked="" type="checkbox"/> Everyday	00 (hour)	00 (min)	~	24 (hour) 00 (min)
<input type="radio"/> On <input type="radio"/> Off	<input type="checkbox"/> Mon	00 (hour)	00 (min)	~	00 (hour) 00 (min)
<input type="radio"/> On <input type="radio"/> Off	<input type="checkbox"/> Tue	00 (hour)	00 (min)	~	00 (hour) 00 (min)
<input type="radio"/> On <input type="radio"/> Off	<input type="checkbox"/> Wed	00 (hour)	00 (min)	~	00 (hour) 00 (min)
<input type="radio"/> On <input type="radio"/> Off	<input type="checkbox"/> Thu	00 (hour)	00 (min)	~	00 (hour) 00 (min)
<input type="radio"/> On <input type="radio"/> Off	<input type="checkbox"/> Fri	00 (hour)	00 (min)	~	00 (hour) 00 (min)
<input type="radio"/> On <input type="radio"/> Off	<input type="checkbox"/> Sat	00 (hour)	00 (min)	~	00 (hour) 00 (min)
<input type="radio"/> On <input type="radio"/> Off	<input type="checkbox"/> Sun	00 (hour)	00 (min)	~	00 (hour) 00 (min)

Note: For a full day, please specify the begin time 00:00 and end time 24:00

Apply Reset

The following table describes the labels in this screen.

Table 47 Network > Wireless LAN 2.4G/5G > Scheduling

LABEL	DESCRIPTION
Wireless LAN Scheduling	
Enable Wireless LAN Scheduling	Select this to enable Wireless LAN scheduling.
Scheduling	
WLAN Status	Select On or Off to specify whether the Wireless LAN is turned on or off. This field works in conjunction with the Day and For the following times fields.
Day	Select Everyday or the specific days to turn the Wireless LAN on or off. If you select Everyday you can not select any specific days. This field works in conjunction with the For the following times field.
For the following times (24-Hour Format)	Select a begin time using the first set of hour and minute (min) drop down boxes and select an end time using the second set of hour and minute (min) drop down boxes. If you have chosen On earlier for the WLAN Status the Wireless LAN will turn on between the two times you enter in these fields. If you have chosen Off earlier for the WLAN Status the Wireless LAN will turn off between the two times you enter in these fields.
Apply	Click Apply to save your changes back to the NBG.
Reset	Click Reset to begin configuring this screen afresh.

11.12 Guest WLAN Screen

This screen allows you to enable and configure multiple wireless networks and guest wireless network settings on the NBG.

You can configure up to four SSIDs to enable multiple BSSs (Basic Service Sets) on the NBG. This allows you to use one access point to provide several BSSs simultaneously. You can then assign varying security types to different SSIDs. Wireless clients can use different SSIDs to associate with the same access point.

Click **Network > Wireless LAN 2.4G/5G > Guest WLAN**. The following screen displays.

Figure 75 Network > Wireless LAN 2.4G/5G > Guest WLAN

The following table describes the labels in this screen.

Table 48 Network > Wireless LAN 2.4G > Guest WLAN

LABEL	DESCRIPTION
Guest WLAN Setup	
Guest WLAN	Select Enable to activate the guest wireless LAN. Select Disable to turn it off.
Network Name(SSID)	The SSID (Service Set IDentity) identifies the Service Set with which a wireless client is associated. Enter a descriptive name (up to 32 printable characters found on a typical English language keyboard) for the wireless LAN.
Hide SSID	Select this check box to hide the SSID in the outgoing beacon frame so a station cannot obtain the SSID through scanning using a site survey tool.
Guest IP Address	Type an IP address for the devices on the Guest WLAN using this as the gateway IP address.
Guest Subnet Mask	Type the subnet mask for the guest wireless LAN.
Guest Start IP	This field displays the first IP address of guest wireless LAN.
Guest End IP	This field displays the last IP address of guest wireless LAN.
Security	
Security Mode	Select Static WEP , WPA-PSK , WPA2-PSK to add security on this wireless network. The wireless clients which want to associate to this network must have same wireless security settings as this device. After you select to use a security, additional options appears in this screen. Section 11.5 on page 85 for detailed information on different security modes. Or you can select No Security to allow any client to associate this network without authentication. Note: If the WPS function is enabled (default), only No Security and WPA2-PSK are available in this field.
Apply	Click Apply to save your changes to NBG.
Reset	Click Reset to begin configuring this screen afresh.

12.1 IPv6 Overview

IPv6 (Internet Protocol version 6), is designed to enhance IP address size and features. The increase in IPv6 address size to 128 bits (from the 32-bit IPv4 address) allows up to 3.4×10^{38} IP addresses.

Use the **IPv6** screens to configure the IP address for your NBG on the LAN or on the WAN.

12.1.1 What You Can Do in this Chapter

- Use the **General** screen ([Section 12.2 on page 98](#)) to configure the IPv6 connection type.

12.1.2 What You Need to Know

IPv6 Addressing

An 128-bit IPv6 address is written as eight 16-bit hexadecimal blocks separated by colons (:). This is an example IPv6 address `2001:0db8:1a2b:0015:0000:0000:1a2f:0000`.

IPv6 addresses can be abbreviated in two ways:

- Leading zeros in a block can be omitted. So `2001:0db8:1a2b:0015:0000:0000:1a2f:0000` can be written as `2001:db8:1a2b:15:0:0:1a2f:0`.
- Any number of consecutive blocks of zeros can be replaced by a double colon. A double colon can only appear once in an IPv6 address. So `2001:0db8:0000:0000:1a2f:0000:0000:0015` can be written as `2001:0db8::1a2f:0000:0000:0015`, `2001:0db8:0000:0000:1a2f::0015`, `2001:db8::1a2f:0:0:15` OR `2001:db8:0:0:1a2f::15`.

Prefix and Prefix Length

Similar to an IPv4 subnet mask, IPv6 uses an address prefix to represent the network address. An IPv6 prefix length specifies how many most significant bits (start from the left) in the address compose the network address. The prefix length is written as "/x" where x is a number. For example,

```
2001:db8:1a2b:15::1a2f:0/32
```

means that the first 32 bits (`2001:db8`) from the left is the network prefix.

Link-local Address

A link-local address uniquely identifies a device on the local network (the LAN). It is similar to a “private IP address” in IPv4. You can have the same link-local address on multiple interfaces on a device. A link-local unicast address has a predefined prefix of fe80::/10. The link-local unicast address format is as follows.

Table 49 Link-local Unicast Address Format

1111 1110 10	0	Interface ID
10 bits	54 bits	64 bits

Subnet Masking

Both an IPv6 address and IPv6 subnet mask compose of 128-bit binary digits, which are divided into eight 16-bit blocks and written in hexadecimal notation. Hexadecimal uses four bits for each character (1 ~ 10, A ~ F). Each block’s 16 bits are then represented by four hexadecimal characters. For example, FFFF:FFFF:FFFF:FFFF:FC00:0000:0000:0000.

Stateless Autoconfiguration

With stateless autoconfiguration in IPv6, addresses can be uniquely and automatically generated. Unlike DHCPv6 (Dynamic Host Configuration Protocol version six) which is used in IPv6 stateful autoconfiguration, the owner and status of addresses don’t need to be maintained by a DHCP server. Every IPv6 device is able to generate its own and unique IP address automatically when IPv6 is initiated on its interface. It combines the prefix and the interface ID (generated from its own Ethernet MAC address) to form a complete IPv6 address.

When IPv6 is enabled on a device, its interface automatically generates a link-local address (beginning with fe80).

When the NBG’s WAN interface is connected to an ISP with a router and the NBG is set to automatically obtain an IPv6 network prefix from the router for the interface, it generates another address which combines its interface ID and global and subnet information advertised from the router. (In IPv6, all network interfaces can be associated with several addresses.) This is a routable global IP address.

Prefix Delegation

Prefix delegation enables an IPv6 router (the NBG) to use the IPv6 prefix (network address) received from the ISP (or a connected uplink router) for its LAN. The NBG uses the received IPv6 prefix (for example, 2001:db2::/48) to generate its LAN IP address. Through sending Router Advertisements (RAs) regularly by multicast, the router passes the IPv6 prefix information to its LAN hosts. The hosts then can use the prefix to generate their IPv6 addresses.

IPv6 Router Advertisement

An IPv6 router sends router advertisement messages periodically to advertise its presence and other parameters to the hosts in the same network.

DHCPv6

The Dynamic Host Configuration Protocol for IPv6 (DHCPv6, RFC 3315) is a server-client protocol that allows a DHCP server to assign and pass IPv6 network addresses, prefixes and other configuration information to DHCP clients. DHCPv6 servers and clients exchange DHCP messages using UDP.

Each DHCP client and server has a unique DHCP Unique Identifier (DUID), which is used for identification when they are exchanging DHCPv6 messages. The DUID is generated from the MAC address, time, vendor assigned ID and/or the vendor's private enterprise number registered with the IANA. It should not change over time even after you reboot the device.

12.2 General Screen

Use this screen to configure the IP address for your NBG. Click **Network > IPv6 > General**.

Figure 76 Network > IPv6 > General

The screenshot displays the 'General' configuration page for IPv6. It is organized into several sections:

- IPv6 Connection Type Setup:** The 'IPv6 Connection Type' is set to 'Static IPv6'.
- WAN IPv6 Address Setup:**
 - IPv6 Address: 2001:db8:feed:b01::2
 - Subnet Prefix Length: 64
 - Gateway IP Address: 2001:db8:feed:b01::1
 - First DNS Server: 2001:5c0:1000:11::2
 - Second DNS Server: 2001:5c0:1001::194
- LAN IPv6 Address Setup:**
 - LAN IPv6 Address: 2001:db8:feed:b00::1 /64
 - LAN IPv6 Link-local Address: fe80::ee43:f6ff:fe73:4916/64
- Address Auto configuration Setup:**
 - Enable Address Auto configuration
 - Type: Stateful
 - Address (start): 2001:db8:feed:b00 : 10
 - Address (end): 2001:db8:feed:b00 : 20
 - Router Advertisement Lifetime: 1440 (minutes)

At the bottom of the form are 'Apply' and 'Reset' buttons.

The following table describes the labels in this screen.

Table 50 Network > IPv6 > General

LABEL	DESCRIPTION
IPv6 Connection Type Setup	
IPv6 Connection Type	Select Link Local Only to use the link-local address which uniquely identifies a device on the local network (the LAN). Select Static IPv6 if you have a fixed IPv6 address assigned by your ISP. Select DHCPv6 if you want to obtain an IPv6 address from a DHCPv6 server.
WAN IPv6 Address Setup This is available only when you select Static IPv6 in the IPv6 Connection Type field.	
IPv6 Address	Enter the IPv6 address on the WAN side in this field.
Subnet Prefix Length	Enter the address prefix length to specify how many most significant bits in an IPv6 address compose the network address.
Gateway IP Address	Enter the IPv6 address of the next-hop gateway. The gateway is a router or switch on the same segment as your NBG's interface(s). The gateway helps forward packets to their destinations.
First DNS Server Second DNS Server	Specify the DNS server IPv6 address assigned by the ISP.
IPv6 DNS Setup This is available only when you select DHCPv6 in the IPv6 Connection Type field.	
DNS Setup	Select From ISP to have the NBG get the IPv6 DNS server addresses from the ISP automatically. Select User-Defined to have the NBG use the IPv6 DNS server addresses you configure manually.
First DNS Server	Enter the first IPv6 DNS server address assigned by the ISP.
Second DNS Server	Enter the second IPv6 DNS server address assigned by the ISP.
LAN IPv6 Address Setup	
Enable DHCP-PD	Select this option to use DHCPv6 prefix delegation. The NBG will obtain an IPv6 prefix from the ISP or a connected uplink router for the LAN.
LAN IPv6 Address	Enter the IPv6 address for the NBG on the LAN.
LAN IPv6 Link-local Address	This displays the IPv6 link-local address on the NBG interfaces in the LAN.
Address Auto configuration Setup This is not available when you select Link Local Only in the IPv6 Connection Type field.	
Enable Address Auto configuration	Select this option if you want the devices on your local area network to obtain network address that are not managed by a DHCPv6 server.

Table 50 Network > IPv6 > General (continued)

LABEL	DESCRIPTION
Type	<p>Select SLAAC + RDNSS to enable IPv6 stateless auto-configuration on this interface. The interface will generate an IPv6 IP address itself from a prefix obtained from an IPv6 router in the network.</p> <p>Select SLAAC + Stateless DHCPv6 to enable IPv6 stateless auto-configuration on this interface. The interface will get an IPv6 address from an IPv6 router and the DHCP server. The IP address information gets through DHCPv6.</p> <p>Select Stateful to allow a DHCP server to assign and pass IPv6 network addresses, prefixes and other configuration information to DHCP clients.</p>
Router Advertisement Lifetime	Specify how long (in minutes) the IPv6 addresses remain valid.
Address (start)	If you select Stateful in the Type field, specify the range of IPv6 addresses from which the DHCPv6 server assigns to the clients. Enter the smallest value of the last block of the IPv6 addresses which are to be allocated.
Address (end)	If you select Stateful in the Type field, specify the range of IPv6 addresses from which the DHCPv6 server assigns to the clients. Enter the largest value of the last block of the IPv6 addresses which are to be allocated.
Apply	Click Apply to save your changes back to the NBG.
Reset	Click Reset to begin configuring this screen afresh.

13.1 Overview

This chapter discusses the NBG's **WAN** screens. Use these screens to configure your NBG for Internet access.

A WAN (Wide Area Network) connection is an outside connection to another network or the Internet. It connects your private networks such as a LAN (Local Area Network) and other networks, so that a computer in one location can communicate with computers in other locations.

Figure 77 LAN and WAN

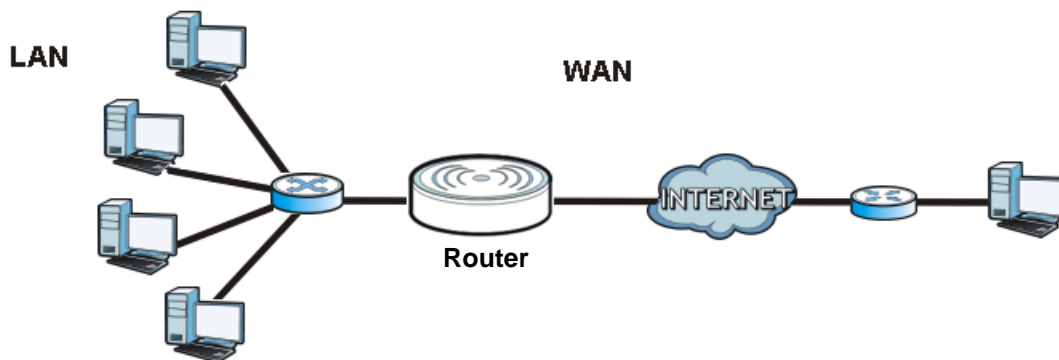

13.2 What You Can Do

- Use the **Internet Connection** screen ([Section 13.4 on page 103](#)) to enter your ISP information and set how the computer acquires its IP, DNS and WAN MAC addresses.
- Use the **Advanced** screen ([Section 13.5 on page 109](#)) to enable multicasting, configure Windows networking and bridge.

13.3 What You Need To Know

The information in this section can help you configure the screens for your WAN connection, as well as enable/disable some advanced features of your NBG.

13.3.1 Configuring Your Internet Connection

Encapsulation Method

Encapsulation is used to include data from an upper layer protocol into a lower layer protocol. To set up a WAN connection to the Internet, you need to use the same encapsulation method used by your ISP (Internet Service Provider). If your ISP offers a dial-up Internet connection using PPPoE (PPP over Ethernet) or PPTP (Point-to-Point Tunneling Protocol), they should also provide a username and password (and service name) for user authentication.

WAN IP Address

The WAN IP address is an IP address for the NBG, which makes it accessible from an outside network. It is used by the NBG to communicate with other devices in other networks. It can be static (fixed) or dynamically assigned by the ISP each time the NBG tries to access the Internet.

If your ISP assigns you a static WAN IP address, they should also assign you the subnet mask and DNS server IP address(es) (and a gateway IP address if you use the Ethernet or ENET ENCAP encapsulation method).

DNS Server Address Assignment

Use Domain Name System (DNS) to map a domain name to its corresponding IP address and vice versa, for instance, the IP address of www.zyxel.com is 204.217.0.2. The DNS server is extremely important because without it, you must know the IP address of a computer before you can access it.

The NBG can get the DNS server addresses in the following ways.

- 1 The ISP tells you the DNS server addresses, usually in the form of an information sheet, when you sign up. If your ISP gives you DNS server addresses, manually enter them in the DNS server fields.
- 2 If your ISP dynamically assigns the DNS server IP addresses (along with the NBG's WAN IP address), set the DNS server fields to get the DNS server address from the ISP.

WAN MAC Address

The MAC address screen allows users to configure the WAN port's MAC address by either using the factory default or cloning the MAC address from a computer on your LAN. Choose **Factory Default** to select the factory assigned default MAC Address.

Otherwise, click **Clone the computer's MAC address - IP Address** and enter the IP address of the computer on the LAN whose MAC you are cloning. Once it is successfully configured, the address will be copied to configuration file. It is recommended that you clone the MAC address prior to hooking up the WAN Port.

13.3.2 Multicast

Traditionally, IP packets are transmitted in one of either two ways - Unicast (1 sender - 1 recipient) or Broadcast (1 sender - everybody on the network). Multicast delivers IP packets to a group of hosts on the network - not everybody and not just 1.

Figure 78 Multicast Example

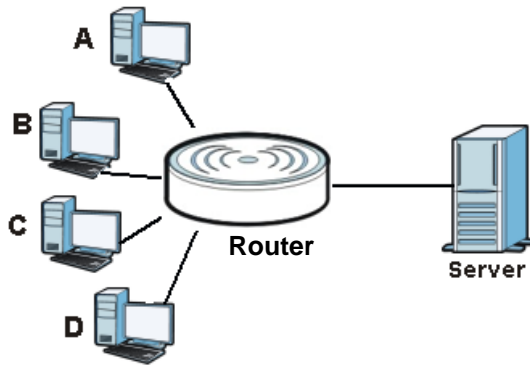

In the multicast example above, systems A and D comprise one multicast group. In multicasting, the server only needs to send one data stream and this is delivered to systems A and D.

IGMP (Internet Group Multicast Protocol) is a network-layer protocol used to establish membership in a multicast group - it is not used to carry user data. The NBG supports both IGMP version 1 (**IGMP-v1**) and IGMP version 2 (**IGMP-v2**).

At start up, the NBG queries all directly connected networks to gather group membership. After that, the NBG periodically updates this information. IP multicasting can be enabled/disabled on the NBG LAN and/or WAN interfaces in the Web Configurator (**LAN**; **WAN**). Select **None** to disable IP multicasting on these interfaces.

13.4 Internet Connection

Use this screen to change your NBG's Internet access settings. Click **WAN** from the Configuration menu. The screen differs according to the encapsulation you choose.

13.4.1 Ethernet Encapsulation

This screen displays when you select **Ethernet** encapsulation.

Figure 79 Network > WAN > Internet Connection: Ethernet Encapsulation

The following table describes the labels in this screen.

Table 51 Network > WAN > Internet Connection: Ethernet Encapsulation

LABEL	DESCRIPTION
ISP Parameters for Internet Access	
Encapsulation	You must choose the Ethernet option when the WAN port is used as a regular Ethernet.
WAN IP Address Assignment	
Get automatically from ISP (Default)	Select this option If your ISP did not assign you a fixed IP address. This is the default selection.
Use Fixed IP Address	Select this option If the ISP assigned a fixed IP address.
IP Address	Enter your WAN IP address in this field if you selected Use Fixed IP Address .
IP Subnet Mask	Enter the IP Subnet Mask in this field.
Gateway IP Address	Enter a Gateway IP Address (if your ISP gave you one) in this field.
MTU Size	Enter the Maximum Transmission Unit (MTU) or the largest packet size per frame that your NBG can receive and process.
WAN DNS Assignment	

Table 51 Network > WAN > Internet Connection: Ethernet Encapsulation (continued)

LABEL	DESCRIPTION
First DNS Server	Select From ISP if your ISP dynamically assigns DNS server information (and the NBG's WAN IP address). The field to the right displays the (read-only) DNS server IP address that the ISP assigns.
Second DNS Server	Select User-Defined if you have the IP address of a DNS server. Enter the DNS server's IP address in the field to the right. If you chose User-Defined , but leave the IP address set to 0.0.0.0, User-Defined changes to None after you click Apply . If you set a second choice to User-Defined , and enter the same IP address, the second User-Defined changes to None after you click Apply . Select None if you do not want to configure DNS servers. If you do not configure a DNS server, you must know the IP address of a computer in order to access it.
WAN MAC Address	The MAC address section allows users to configure the WAN port's MAC address by either using the NBG's MAC address, copying the MAC address from a computer on your LAN or manually entering a MAC address.
Factory default	Select Factory default to use the factory assigned default MAC Address.
Clone the computer's MAC address - IP Address	Select Clone the computer's MAC address - IP Address and enter the IP address of the computer on the LAN whose MAC you are cloning.
Set WAN MAC Address	Select this option and enter the MAC address you want to use.
Apply	Click Apply to save your changes back to the NBG.
Reset	Click Reset to begin configuring this screen afresh.

13.4.2 PPPoE Encapsulation

The NBG supports PPPoE (Point-to-Point Protocol over Ethernet). PPPoE is an IETF standard (RFC 2516) specifying how a personal computer (PC) interacts with a broadband modem (DSL, cable, wireless, etc.) connection. The **PPP over Ethernet** option is for a dial-up connection using PPPoE.

For the service provider, PPPoE offers an access and authentication method that works with existing access control systems (for example Radius).

One of the benefits of PPPoE is the ability to let you access one of multiple network services, a function known as dynamic service selection. This enables the service provider to easily create and offer new IP services for individuals.

Operationally, PPPoE saves significant effort for both you and the ISP or carrier, as it requires no specific configuration of the broadband modem at the customer site.

By implementing PPPoE directly on the NBG (rather than individual computers), the computers on the LAN do not need PPPoE software installed, since the NBG does that part of the task. Furthermore, with NAT, all of the LANs' computers will have access.

This screen displays when you select **PPPoE** encapsulation.

Figure 80 Network > WAN > Internet Connection: PPPoE Encapsulation

The following table describes the labels in this screen.

Table 52 Network > WAN > Internet Connection: PPPoE Encapsulation

LABEL	DESCRIPTION
ISP Parameters for Internet Access	
Encapsulation	Select PPP over Ethernet if you connect to your Internet via dial-up.
Service Name	
User Name	Type the user name given to you by your ISP.
Password	Type the password associated with the user name above.
Retype to Confirm	Type your password again to make sure that you have entered is correctly.
MTU Size	Enter the Maximum Transmission Unit (MTU) or the largest packet size per frame that your NBG can receive and process.
Nailed-Up Connection	Select Nailed-Up Connection if you do not want the connection to time out.
Idle Timeout (min)	This value specifies the time in minutes that elapses before the router automatically disconnects from the PPPoE server.
WAN DNS Assignment	

Table 52 Network > WAN > Internet Connection: PPPoE Encapsulation (continued)

LABEL	DESCRIPTION
First DNS Server Second DNS Server	<p>Select From ISP if your ISP dynamically assigns DNS server information (and the NBG's WAN IP address). The field to the right displays the (read-only) DNS server IP address that the ISP assigns.</p> <p>Select User-Defined if you have the IP address of a DNS server. Enter the DNS server's IP address in the field to the right. If you chose User-Defined, but leave the IP address set to 0.0.0.0, User-Defined changes to None after you click Apply. If you set a second choice to User-Defined, and enter the same IP address, the second User-Defined changes to None after you click Apply.</p> <p>Select None if you do not want to configure DNS servers. If you do not configure a DNS server, you must know the IP address of a computer in order to access it.</p>
WAN MAC Address	The MAC address section allows users to configure the WAN port's MAC address by using the NBG's MAC address, copying the MAC address from a computer on your LAN or manually entering a MAC address.
Factory default	Select Factory default to use the factory assigned default MAC Address.
Clone the computer's MAC address - IP Address	Select Clone the computer's MAC address - IP Address and enter the IP address of the computer on the LAN whose MAC you are cloning.
Set WAN MAC Address	Select this option and enter the MAC address you want to use.
Apply	Click Apply to save your changes back to the NBG.
Reset	Click Reset to begin configuring this screen afresh.

13.4.3 PPTP Encapsulation

Point-to-Point Tunneling Protocol (PPTP) is a network protocol that enables secure transfer of data from a remote client to a private server, creating a Virtual Private Network (VPN) using TCP/IP-based networks.

PPTP supports on-demand, multi-protocol and virtual private networking over public networks, such as the Internet.

Note: PPTP will be supported in the next firmware version.

This screen displays when you select **PPTP** encapsulation.

Figure 81 Network > WAN > Internet Connection: PPTP Encapsulation

The following table describes the labels in this screen.

Table 53 Network > WAN > Internet Connection: PPTP Encapsulation

LABEL	DESCRIPTION
ISP Parameters for Internet Access	
Encapsulation	To configure a PPTP client, you must configure the User Name and Password fields for a PPP connection and the PPTP parameters for a PPTP connection.
User Name	Type the user name given to you by your ISP.
Password	Type the password associated with the User Name above.
Retype to Confirm	Type your password again to make sure that you have entered is correctly.
Nailed-up Connection	Select Nailed-Up Connection if you do not want the connection to time out.

Table 53 Network > WAN > Internet Connection: PPTP Encapsulation (continued)

LABEL	DESCRIPTION
Idle Timeout (min)	This value specifies the time in minutes that elapses before the NBG automatically disconnects from the PPTP server.
PPTP Configuration	
Server IP Address	Type the IP address of the PPTP server.
Get automatically from ISP	Select this option If your ISP did not assign you a fixed IP address. This is the default selection.
Use Fixed IP Address	Select this option If the ISP assigned a fixed IP address.
IP Address	Enter your WAN IP address in this field if you selected Use Fixed IP Address .
IP Subnet Mask	Your NBG will automatically calculate the subnet mask based on the IP address that you assign. Unless you are implementing subnetting, use the subnet mask computed by the NBG.
Gateway IP Address	Enter a Gateway IP Address (if your ISP gave you one) in this field.
MTU Size	Enter the Maximum Transmission Unit (MTU) or the largest packet size per frame that your NBG can receive and process.
WAN DNS Assignment	
First DNS Server Second DNS Server	Select From ISP if your ISP dynamically assigns DNS server information (and the NBG's WAN IP address). The field to the right displays the (read-only) DNS server IP address that the ISP assigns. Select User-Defined if you have the IP address of a DNS server. Enter the DNS server's IP address in the field to the right. If you chose User-Defined , but leave the IP address set to 0.0.0.0, User-Defined changes to None after you click Apply . If you set a second choice to User-Defined , and enter the same IP address, the second User-Defined changes to None after you click Apply . Select None if you do not want to configure DNS servers. If you do not configure a DNS server, you must know the IP address of a computer in order to access it.
WAN MAC Address	The MAC address section allows users to configure the WAN port's MAC address by either using the NBG's MAC address, copying the MAC address from a computer on your LAN or manually entering a MAC address.
Factory default	Select Factory default to use the factory assigned default MAC Address.
Clone the computer's MAC address - IP Address	Select Clone the computer's MAC address - IP Address and enter the IP address of the computer on the LAN whose MAC you are cloning.
Set WAN MAC Address	Select this option and enter the MAC address you want to use.
Apply	Click Apply to save your changes back to the NBG.
Reset	Click Reset to begin configuring this screen afresh.

13.5 Advanced WAN Screen

Use this screen to enable **Multicast**.

Note: The categories shown in this screen are independent of each other.

To change your NBG's advanced WAN settings, click **Network > WAN > Advanced**. The screen appears as shown.

Figure 82 Network > WAN > Advanced

The following table describes the labels in this screen.

Table 54 Network > WAN > Advanced

LABEL	DESCRIPTION
Multicast Setup	
Multicast	Select IGMPv1/v2 to enable multicasting. This applies to traffic routed from the WAN to the LAN. Select None to disable this feature. This may cause incoming traffic to be dropped or sent to all connected network devices.
Auto-Subnet Configuration	
None	Select this option to have the NBG do nothing when it gets a WAN IP address in the range of 192.168.x.y (where x and y are from zero to nine) or in the same subnet as the LAN IP address.
Enable Auto-IP-Change mode	Select this option to have the NBG change its LAN IP address to 10.0.0.1 or 192.168.1.1 accordingly when the NBG gets a dynamic WAN IP address in the same subnet as the LAN IP address 192.168.1.1 or 10.0.0.1. The NAT, DHCP server and firewall functions on the NBG are still available in this mode.
Apply	Click Apply to save your changes back to the NBG.
Reset	Click Reset to begin configuring this screen afresh.

14.1 Overview

This chapter describes how to configure LAN settings.

A Local Area Network (LAN) is a shared communication system to which many computers are attached. A LAN is a computer network limited to the immediate area, usually the same building or floor of a building. The LAN screens can help you configure a LAN DHCP server, manage IP addresses, and partition your physical network into logical networks.

Figure 83 LAN Example

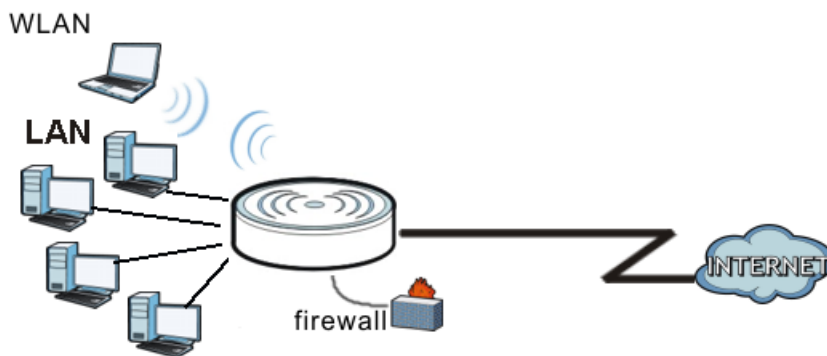

The LAN screens can help you manage IP addresses.

14.2 What You Can Do

- Use the **IP** screen ([Section 14.4 on page 112](#)) to change the IP address for your NBG.

14.3 What You Need To Know

The actual physical connection determines whether the NBG ports are LAN or WAN ports. There are two separate IP networks, one inside the LAN network and the other outside the WAN network as shown next.

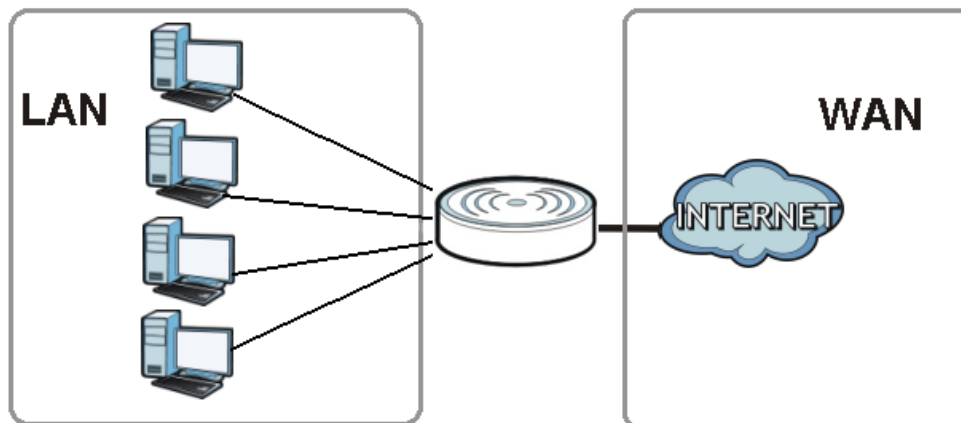
Figure 84 LAN and WAN IP Addresses

The LAN parameters of the NBG are preset in the factory with the following values:

- IP address of 192.168.1.1 with subnet mask of 255.255.255.0 (24 bits)
- DHCP server enabled with 32 client IP addresses starting from 192.168.1.33.

These parameters should work for the majority of installations. If your ISP gives you explicit DNS server address(es), read the embedded Web Configurator help regarding what fields need to be configured.

14.3.1 IP Pool Setup

The NBG is pre-configured with a pool of 32 IP addresses starting from 192.168.1.33 to 192.168.1.64. This configuration leaves 31 IP addresses (excluding the NBG itself) in the lower range (192.168.1.2 to 192.168.1.32) for other server computers, for instance, servers for mail, FTP, TFTP, web, etc., that you may have.

14.3.2 LAN TCP/IP

The NBG has built-in DHCP server capability that assigns IP addresses and DNS servers to systems that support DHCP client capability.

14.3.3 IP Alias

IP alias allows you to partition a physical network into different logical networks over the same Ethernet interface. The NBG supports three logical LAN interfaces via its single physical Ethernet interface with the NBG itself as the gateway for each LAN network.

14.4 LAN IP Screen

Use this screen to change the IP address for your NBG. Click **Network > LAN > IP**.

Figure 85 Network > LAN > IP

The screenshot shows a web-based configuration interface. At the top, there is a dark blue header with the text 'IP'. Below the header, the main content area is white and contains the text 'LAN TCP/IP'. Underneath, there are two rows of configuration fields. The first row is labeled 'IP Address :' and has a text input box containing '192.168.1.1'. The second row is labeled 'IP Subnet Mask :' and has a text input box containing '255.255.255.0'. At the bottom of the form, there is a light blue bar containing two buttons: 'Apply' and 'Reset'.

The following table describes the labels in this screen.

Table 55 Network > LAN > IP

LABEL	DESCRIPTION
IP Address	Type the IP address of your NBG in dotted decimal notation.
IP Subnet Mask	The subnet mask specifies the network number portion of an IP address. Your NBG will automatically calculate the subnet mask based on the IP address that you assign. Unless you are implementing subnetting, use the subnet mask computed by the NBG.
Apply	Click Apply to save your changes back to the NBG.
Reset	Click Reset to begin configuring this screen afresh.

DHCP Server

15.1 Overview

DHCP (Dynamic Host Configuration Protocol, RFC 2131 and RFC 2132) allows individual clients to obtain TCP/IP configuration at start-up from a server. You can configure the NBG's LAN as a DHCP server or disable it. When configured as a server, the NBG provides the TCP/IP configuration for the clients. If DHCP service is disabled, you must have another DHCP server on your LAN, or else the computer must be manually configured.

15.2 What You Can Do

- Use the **General** ([Section 15.3 on page 114](#)) screen to enable the DHCP server.
- Use the **Advanced** ([Section 15.4 on page 115](#)) screen to assign IP addresses on the LAN to specific individual computers based on their MAC Addresses.

15.3 General Screen

Use this screen to enable the DHCP server. Click **Network > DHCP Server**. The following screen displays.

Figure 86 Network > DHCP Server > General

The following table describes the labels in this screen.

Table 56 Network > DHCP Server > General

LABEL	DESCRIPTION
Enable DHCP Server	Select this check box to activate the DHCP for LAN.
IP Pool Starting Address	This field specifies the first of the contiguous addresses in the IP address pool for LAN.
End Address	This field specifies the last of the contiguous addresses in the IP address pool for LAN.

Table 56 Network > DHCP Server > General (continued)

LABEL	DESCRIPTION
Apply	Click Apply to save your changes back to the NBG.
Reset	Click Reset to begin configuring this screen afresh.

15.4 Advanced Screen

This screen allows you to assign IP addresses on the LAN to specific individual computers based on their MAC addresses. You can also use this screen to configure the DNS server information that the NBG sends to the DHCP clients.

To change your NBG's static DHCP settings, click **Network > DHCP Server > Advanced**. The following screen displays.

Figure 87 Network > DHCP Server > Advanced

The following table describes the labels in this screen.

Table 57 Network > DHCP Server > Advanced

LABEL	DESCRIPTION
Add Application Rule	
IP Address	Type the LAN IP address based on the MAC address in dotted decimal notation.
MAC Address	Type the MAC address (with colons) you want to assign to your NBG
LAN Static DHCP Table	
#	This is the index number of the static IP table entry (row).
IP Address	Type the LAN IP address of a computer on your LAN.
MAC Address	Type the MAC address (with colons) of a computer on your LAN.
Modify	Click the Edit icon to open the edit screen where you can modify an IP address. Click the Delete icon to remove an IP address.
DNS Server	

Table 57 Network > DHCP Server > Advanced (continued)

LABEL	DESCRIPTION
DNS Servers Assigned by DHCP Server	The NBG passes a DNS (Domain Name System) server IP address (in the order you specify here) to the DHCP clients. The NBG only passes this information to the LAN DHCP clients when you select the Enable DHCP Server check box. When you clear the Enable DHCP Server check box, DHCP service is disabled and you must have another DHCP sever on your LAN, or else the computers must have their DNS server addresses manually configured.
First DNS Server Second DNS Server	<p>Select From ISP if your ISP dynamically assigns DNS server information (and the NBG's WAN IP address). The field to the right displays the (read-only) DNS server IP address that the ISP assigns.</p> <p>Select User-Defined if you have the IP address of a DNS server. Enter the DNS server's IP address in the field to the right. If you chose User-Defined, but leave the IP address set to 0.0.0.0, User-Defined changes to None after you click Apply. If you set a second choice to User-Defined, and enter the same IP address, the second User-Defined changes to None after you click Apply.</p> <p>Select DNS Relay to have the NBG act as a DNS proxy. The NBG's LAN IP address displays in the field to the right (read-only). The NBG tells the DHCP clients on the LAN that the NBG itself is the DNS server. When a computer on the LAN sends a DNS query to the NBG, the NBG forwards the query to the NBG's system DNS server (configured in the WAN > Internet Connection screen) and relays the response back to the computer. You can only select DNS Relay for one of the three servers; if you select DNS Relay for a second or third DNS server, that choice changes to None after you click Apply.</p> <p>Select None if you do not want to configure DNS servers. If you do not configure a DNS server, you must know the IP address of a computer in order to access it.</p>
Apply	Click Apply to save your changes back to the NBG.
Reset	Click Reset to begin configuring this screen afresh.

Network Address Translation (NAT)

16.1 Overview

NAT (Network Address Translation - NAT, RFC 1631) is the translation of the IP address of a host in a packet. For example, the source address of an outgoing packet, used within one network is changed to a different IP address known within another network.

Each packet has two addresses – a source address and a destination address. For outgoing packets, NAT maps private (local) IP addresses to globally unique ones required for communication with hosts on other networks. It replaces the original IP source address in each packet and then forwards it to the Internet. The NBG keeps track of the original addresses and port numbers so incoming reply packets can have their original values restored. The following figure illustrates this.

Figure 88 NAT Example

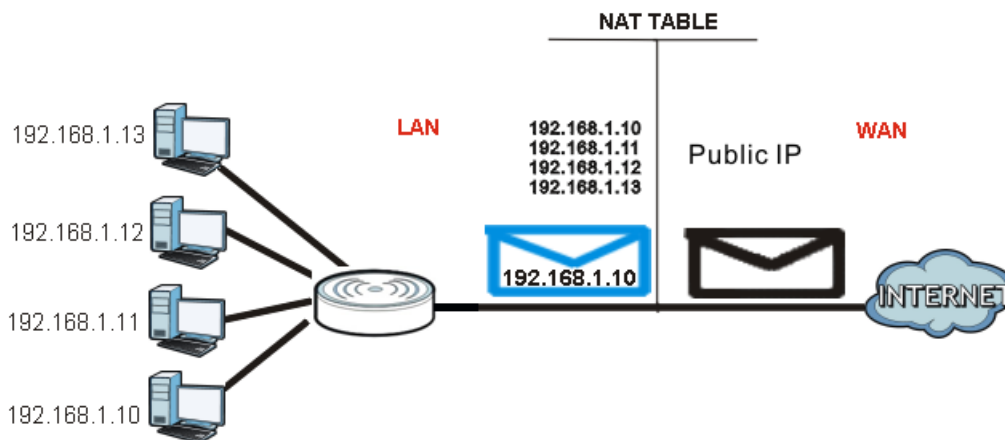

For more information on IP address translation, refer to *RFC 1631, The IP Network Address Translator (NAT)*.

16.2 What You Can Do

- Use the **General** screen ([Section 16.3 on page 118](#)) to enable NAT and set a default server.
- Use the **Application** screen ([Section 16.4 on page 118](#)) to forward incoming service requests to the server(s) on your local network.
- Use the **Advanced** screen ([Section 16.5 on page 120](#)) to change your NBG's trigger port settings.

16.3 General NAT Screen

Use this screen to enable NAT and set a default server. Click **Network > NAT > General** to open the following screen.

Figure 89 Network > NAT > General

The following table describes the labels in this screen.

Table 58 Network > NAT > General

LABEL	DESCRIPTION
NAT Setup	
Enable Network Address Translation	Network Address Translation (NAT) allows the translation of an Internet protocol address used within one network (for example a private IP address used in a local network) to a different IP address known within another network (for example a public IP address used on the Internet). Select the check box to enable NAT.
Default Server Setup	
Server IP Address	In addition to the servers for specified services, NAT supports a default server. A default server receives packets from ports that are not specified in the Application screen. If you do not assign a Default Server IP address , the NBG discards all packets received for ports that are not specified in the Application screen or remote management.
Apply	Click Apply to save your changes back to the NBG.
Reset	Click Reset to begin configuring this screen afresh.

16.4 NAT Application Screen

Use the **Application** screen to forward incoming service requests to the server(s) on your local network. You may enter a single port number or a range of port numbers to be forwarded, and the local IP address of the desired server. The port number identifies a service; for example, web service is on port 80 and FTP on port 21. In some cases, such as for unknown services or where one server can support more than one service (for example both FTP and web service), it might be better to specify a range of port numbers.

In addition to the servers for specified services, NAT supports a default server. A service request that does not have a server explicitly designated for it is forwarded to the default server. If the default is not defined, the service request is simply discarded.

Note: Many residential broadband ISP accounts do not allow you to run any server processes (such as a Web or FTP server) from your location. Your ISP may periodically check for servers and may suspend your account if it discovers any active services at your location. If you are unsure, refer to your ISP.

Port forwarding allows you to define the local servers to which the incoming services will be forwarded. To change your NBG's port forwarding settings, click **Network > NAT > Application**. The screen appears as shown.

Note: If you do not assign a **Default Server IP address** in the **NAT > General** screen, the NBG discards all packets received for ports that are not specified in this screen or remote management.

Refer to [Appendix D on page 225](#) for port numbers commonly used for particular services.

Figure 90 Network > NAT > Application

The following table describes the labels in this screen.

Table 59 Network > NAT > Application

LABEL	DESCRIPTION
Add Application Rule	
Active	Select the check box to enable this rule and the requested service can be forwarded to the host with a specified internal IP address. Clear the checkbox to disallow forwarding of these ports to an inside server without having to delete the entry.
Service Name	Type a name (of up to 31 printable characters) to identify this rule in the first field next to Service Name . Otherwise, select a predefined service in the second field next to Service Name . The predefined service name and port number(s) will display in the Service Name and Port fields.
Port	Type a port number(s) to define the service to be forwarded to the specified server. To specify a range of ports, enter a hyphen (-) between the first port and the last port, such as 10-20. To specify two or more non-consecutive port numbers, separate them by a comma without spaces, such as 123,567.
Server IP Address	Type the IP address of the server on your LAN that receives packets from the port(s) specified in the Port field.

Table 59 Network > NAT > Application (continued)

LABEL	DESCRIPTION
Application Rules Summary	
#	This is the number of an individual port forwarding server entry.
Active	This icon is turned on when the rule is enabled.
Name	This field displays a name to identify this rule.
Port	This field displays the port number(s).
Server IP Address	This field displays the inside IP address of the server.
Modify	Click the Edit icon to display and modify an existing rule setting in the fields under Add Application Rule . Click the Remove icon to delete a rule.
Apply	Click Apply to save your changes back to the NBG.
Reset	Click Reset to begin configuring this screen afresh.

16.5 NAT Advanced Screen

Some services use a dedicated range of ports on the client side and a dedicated range of ports on the server side. With regular port forwarding you set a forwarding port in NAT to forward a service (coming in from the server on the WAN) to the IP address of a computer on the client side (LAN). The problem is that port forwarding only forwards a service to a single LAN IP address. In order to use the same service on a different LAN computer, you have to manually replace the LAN computer's IP address in the forwarding port with another LAN computer's IP address.

Trigger port forwarding solves this problem by allowing computers on the LAN to dynamically take turns using the service. The NBG records the IP address of a LAN computer that sends traffic to the WAN to request a service with a specific port number and protocol (a "trigger" port). When the NBG's WAN port receives a response with a specific port number and protocol ("incoming" port), the NBG forwards the traffic to the LAN IP address of the computer that sent the request. After that computer's connection for that service closes, another computer on the LAN can use the service in the same manner. This way you do not need to configure a new IP address each time you want a different LAN computer to use the application.

To change your NBG's trigger port settings, click **Network > NAT > Advanced**. The screen appears as shown.

Note: Only one LAN computer can use a trigger port (range) at a time.

Figure 91 Network > NAT > Advanced

The following table describes the labels in this screen.

Table 60 Network > NAT > Advanced

LABEL	DESCRIPTION
Add Application Rule	
Service Name	Type a unique name (up to 15 characters) for identification purposes. All characters are permitted - including spaces.
Trigger Port	The trigger port is a port (or a range of ports) that causes (or triggers) the NBG to record the IP address of the LAN computer that sent the traffic to a server on the WAN. Select the transport layer protocol used for the service. Choices are TCP , UDP , or Both . Type a port number or a range of port numbers.
Incoming Port	Incoming is a port (or a range of ports) that a server on the WAN uses when it sends out a particular service. The NBG forwards the traffic with this port (or range of ports) to the client computer on the LAN that requested the service. Select the transport layer protocol used for the service. Choices are TCP , UDP , or Both . Type a port number or a range of port numbers.
Application Rules Summary	
#	This is the rule index number (read-only).
Active	This icon is turned on when the rule is enabled.
Name	This field displays a name to identify this rule.
Trigger Port	This field displays the protocol and the port number or a range of port numbers.
Incoming Port	This field displays the protocol and the port number or a range of port numbers.
Modify	Click the Edit icon to edit the port triggering rule. Click the Delete icon to delete an existing rule.
Apply	Click Apply to save your changes back to the NBG.
Reset	Click Reset to begin configuring this screen afresh.

16.5.1 Trigger Port Forwarding Example

The following is an example of trigger port forwarding.

Figure 92 Trigger Port Forwarding Process: Example
Jane's computer

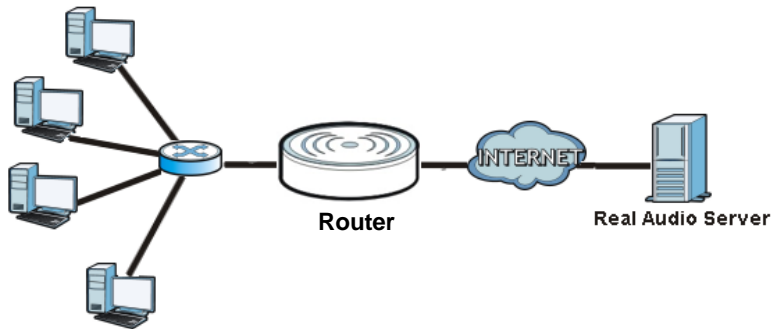

- 1 Jane requests a file from the Real Audio server (port 7070).
- 2 Port 7070 is a "trigger" port and causes the NBG to record Jane's computer IP address. The NBG associates Jane's computer IP address with the "incoming" port range of 6970-7170.
- 3 The Real Audio server responds using a port number ranging between 6970-7170.
- 4 The NBG forwards the traffic to Jane's computer IP address.
- 5 Only Jane can connect to the Real Audio server until the connection is closed or times out. The NBG times out in three minutes with UDP (User Datagram Protocol), or two hours with TCP/IP (Transfer Control Protocol/Internet Protocol).

16.5.2 Two Points To Remember About Trigger Ports

- 1 Trigger events only happen on data that is going coming from inside the NBG and going to the outside.
- 2 If an application needs a continuous data stream, that port (range) will be tied up so that another computer on the LAN can't trigger it.

Dynamic DNS

17.1 Overview

Dynamic DNS (DDNS) services let you use a domain name with a dynamic IP address.

17.2 What You Can Do

Use the **Dynamic DNS** screen ([Section 17.4 on page 123](#)) to enable DDNS and configure the DDNS settings on the NBG.

17.3 What You Need To Know

Dynamic DNS allows you to update your current dynamic IP address with one or many dynamic DNS services so that anyone can contact you (in NetMeeting, CU-SeeMe, etc.). You can also access your FTP server or Web site on your own computer using a domain name (for instance myhost.dhs.org, where myhost is a name of your choice) that will never change instead of using an IP address that changes each time you reconnect. Your friends or relatives will always be able to call you even if they don't know your IP address.

17.4 Dynamic DNS Screen

To change your NBG's DDNS, click **Network > DDNS**. The screen appears as shown.

Figure 93 Network > DDNS

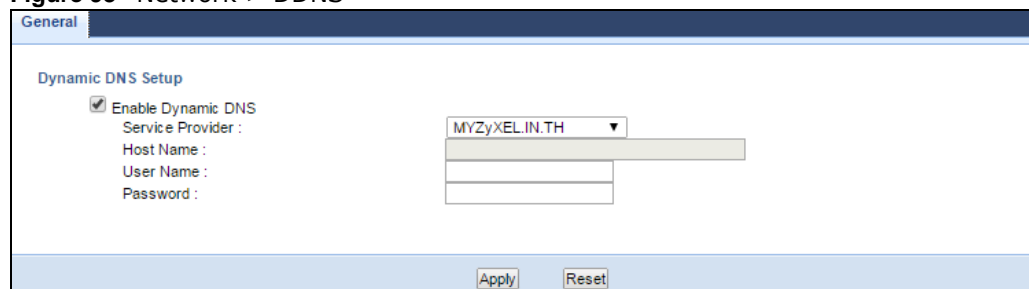

The screenshot shows the 'Dynamic DNS Setup' screen under the 'General' tab. It includes a checkbox for 'Enable Dynamic DNS' which is checked. Below it are fields for 'Service Provider' (a dropdown menu showing 'MYZyXEL.IN.TH'), 'Host Name', 'User Name', and 'Password'. At the bottom of the form are 'Apply' and 'Reset' buttons.

The following table describes the labels in this screen.

Table 61 Network > DDNS

LABEL	DESCRIPTION
Enable Dynamic DNS	Select this check box to use dynamic DNS.
Service Provider	Select the name of your Dynamic DNS service provider.
Host Name	Enter a host names in the field provided. You can specify up to two host names in the field separated by a comma (",").
User Name	Enter your user name.
Password	Enter the password assigned to you.
Apply	Click Apply to save your changes back to the NBG.
Reset	Click Reset to begin configuring this screen afresh.

Static Route

18.1 Overview

This chapter shows you how to configure static routes for your NBG.

Each remote node specifies only the network to which the gateway is directly connected, and the NBG has no knowledge of the networks beyond. For instance, the NBG knows about network N2 in the following figure through remote node Router 1. However, the NBG is unable to route a packet to network N3 because it doesn't know that there is a route through the same remote node Router 1 (via gateway Router 2). The static routes are for you to tell the NBG about the networks beyond the remote nodes.

Figure 94 Example of Static Routing Topology

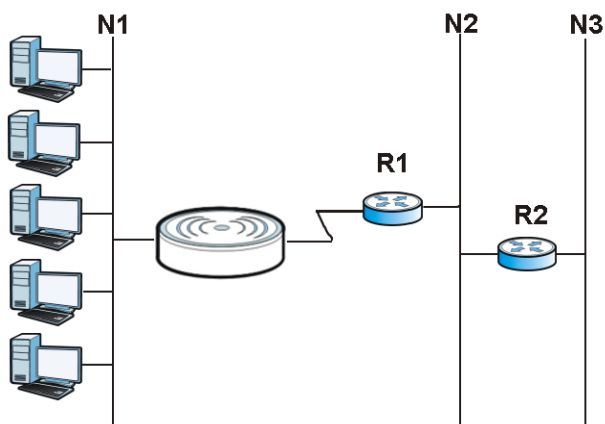

18.2 What You Can Do

Use the **IP Static Route** screen ([Section 18.3 on page 125](#)) to view, add and delete routes.

18.3 IP Static Route Screen

Click **Network > Static Route** to open the **IP Static Route** screen.

Figure 95 Network > Static Route

The screenshot shows a web interface for configuring static routes. It includes a title bar 'IP Static Route', a 'Static Routing Settings' section with several input fields and a dropdown menu, an 'Add Rule' button, a summary table, and a 'Reset' button at the bottom.

The following table describes the labels in this screen.

Table 62 Network > Static Route

LABEL	DESCRIPTION
Static Routing Settings	
Route Name	Enter a the name that describes or identifies this route.
Destination IP Address	Enter the IP network address of the final destination.
IP Subnet Mask	This is the subnet to which the route's final destination belongs.
Gateway IP Address	Enter the the IP address of the gateway.
Metric	Assign a number to identify the route.
Interface	Select the NBG port types. The port types are WAN and LAN .
Add Rule	Click this to add the IP static route.
Application Rules Summary	
#	This is the number of an individual static route.
Active	The rules are always on and this is indicated by the icon.
Route Name	This is the name that describes or identifies this route.
Destination	This parameter specifies the IP network address of the final destination. Routing is always based on network number.
Gateway	This is the IP address of the gateway. The gateway is a router or switch on the same network segment as the device's LAN or WAN port. The gateway helps forward packets to their destinations.
Metric	This is the number assigned to the route.
Interface	This displays the NBG port types. The port types are WAN and LAN .
Delete	Click the Delete icon to remove a static route from the NBG. A window displays asking you to confirm that you want to delete the route.
Reset	Click Reset to begin configuring this screen afresh.

19.1 Overview

This chapter shows you how to enable and configure the firewall that protects your NBG and your LAN from unwanted or malicious traffic.

Enable the firewall to protect your LAN computers from attacks by hackers on the Internet and control access between the LAN and WAN. By default the firewall:

- allows traffic that originates from your LAN computers to go to all of the networks.
- blocks traffic that originates on the other networks from going to the LAN.

The following figure illustrates the default firewall action. User **A** can initiate an IM (Instant Messaging) session from the LAN to the WAN (1). Return traffic for this session is also allowed (2). However other traffic initiated from the WAN is blocked (3 and 4).

Figure 96 Default Firewall Action

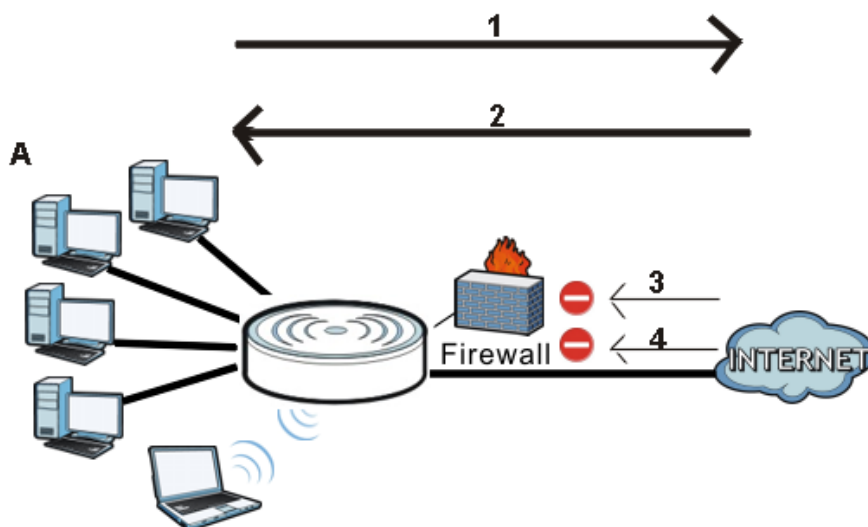

19.2 What You Can Do

- Use the **General** ([Section 19.4 on page 128](#)) screen to enable or disable the NBG's firewall.
- Use the **MAC Filtering Rule** screen ([Section 19.5 on page 129](#)) to configure the NBG to block access to devices or block the devices from accessing the NBG.
- Use the **IP Filtering Rule** screen ([Section 19.6 on page 130](#)) to configure the NBG to block access to devices or block the devices from accessing the NBG.

19.3 What You Need To Know

The NBG's firewall feature physically separates the LAN and the WAN and acts as a secure gateway for all data passing between the networks.

It is designed to protect against Denial of Service (DoS) attacks when activated (click the **General** tab under **Firewall** and then click the **Enable Firewall** check box). The NBG's purpose is to allow a private Local Area Network (LAN) to be securely connected to the Internet. The NBG can be used to prevent theft, destruction and modification of data, as well as log events, which may be important to the security of your network.

The NBG is installed between the LAN and a broadband modem connecting to the Internet. This allows it to act as a secure gateway for all data passing between the Internet and the LAN.

The NBG has one Ethernet WAN port and four Ethernet LAN ports, which are used to physically separate the network into two areas. The WAN (Wide Area Network) port attaches to the broadband (cable or DSL) modem to the Internet.

The LAN (Local Area Network) port attaches to a network of computers, which needs security from the outside world. These computers will have access to Internet services such as e-mail, FTP and the World Wide Web. However, "inbound access" is not allowed (by default) unless the remote host is authorized to use a specific service.

19.4 General Firewall Screen

Use this screen to enable or disable the NBG's firewall, and set up firewall logs. Click **Security > Firewall** to open the **General** screen.

Figure 97 Security > Firewall > General

The screenshot shows a web-based configuration interface for the NBG's firewall. At the top, there are three tabs: 'General', 'MAC Filtering Rule', and 'IP Filtering Rule'. The 'General' tab is active. Below the tabs, the 'Firewall Setup' section contains a checked checkbox for 'Enable Firewall'. Below that, the 'ICMP' section contains an unchecked checkbox for 'Enable ICMP(WAN Ping)'. At the bottom of the screen, there are two buttons: 'Apply' and 'Reset'.

The following table describes the labels in this screen.

Table 63 Security > Firewall > General

LABEL	DESCRIPTION
Firewall Setup	
Enable Firewall	Select this check box to activate the firewall. The NBG performs access control and protects against Denial of Service (DoS) attacks when the firewall is activated.

Table 63 Security > Firewall > General

LABEL	DESCRIPTION
ICMP	Internet Control Message Protocol is a message control and error-reporting protocol between a host server and a gateway to the Internet. ICMP uses Internet Protocol (IP) datagrams, but the messages are processed by the TCP/IP software and directly apparent to the application user.
Enable ICMP (WAN Ping)	Select this check box to activate the ICMP. The NBG will respond to WAN incoming Ping requests.
Apply	Click Apply to save the settings.
Reset	Click Reset to start configuring this screen again.

19.5 MAC Filtering Rule Screen

If an outside user attempts to probe an unsupported port on your NBG, an ICMP response packet is automatically returned. This allows the outside user to know the NBG exists. Use this screen to prevent the ICMP response packet from being sent. This keeps outsiders from discovering your NBG when unsupported ports are probed.

You can also use this screen to enable service blocking, enter/delete/modify the services you want to block and the date/time you want to block them.

Click **Security > Firewall > MAC Filtering Rule**. The screen appears as shown next.

Figure 98 Security > Firewall > MAC Filtering Rule

General | **MAC Filtering Rule** | IP Filtering Rule

MAC Filtering Rule

Enable MAC Filtering Deny Allow

MAC Filtering Table

Client PC MAC Address :

Comment :

MAC Filtering Table			
NO.	Client PC MAC Address	Comment	Select

The following table describes the labels in this screen.

Table 64 Security > Firewall > MAC Filtering Rule

LABEL	DESCRIPTION
MAC Filtering Rule	
Enable MAC Filtering	Select this check box to enable MAC address filtering. Define the filter action for the list of MAC addresses in the MAC Filtering Table . Select Allow to permit access to the NBG, MAC addresses not listed will be denied access to the NBG. Select Deny to block access to the NBG, MAC addresses not listed will be allowed to access the NBG.
MAC Filtering Table	
Client PC MAC Address	Enter the MAC address of the computer for which the MAC filtering rule applies.
Comment	Enter a name that identifies or describes the firewall rule.
Add	Click this to add the MAC filtering rule.
MAC Filtering Table	
NO.	This is the number of an individual MAC filtering rule.
Client PC MAC Address	This field displays the MAC address of the computer.
Comment	This field displays the descriptions of the MAC filtering rule.
Select	Select the MAC filtering rule which you want to delete.
Delete Selected	Click the Delete Selected button to remove the MAC filtering rule which selected from the MAC Filtering Table . A window displays asking you to confirm that you want to delete the rule.
Delete All	Click the Delete All button to remove all MAC filtering rules from the NBG. A window displays asking you to confirm that you want to delete all rules.
Apply	Click Apply to save your changes back to the NBG.
Reset	Click Reset to start configuring this screen again.

See [Appendix D on page 225](#) for commonly used services and port numbers.

19.6 IP Filtering Rule Screen

If an outside user attempts to probe an unsupported port on your NBG, an ICMP response packet is automatically returned. This allows the outside user to know the NBG exists. Use this screen to prevent the ICMP response packet from being sent. This keeps outsiders from discovering your NBG when unsupported ports are probed.

You can also use this screen to enable service blocking, enter/delete/modify the services you want to block and the date/time you want to block them.

Click **Security > Firewall > IP Filtering Rule**. The screen appears as shown next.

Figure 99 Security > Firewall > IP Filtering Rule

IP Filtering Rule

Enable IP Filtering Deny Allow

IP Filtering Table

NO.	PC Description	PC IP Address	Client Service	Protocol	Port Range	Select
1	TEST	192.168.1.5-192.168.1.254	WWW	TCP	TCP Port=80,3128,8000,8080,8081	<input type="checkbox"/>
2	TEST2	192.168.1.25-192.168.1.254	NetMeeting DNS SNMP User Define	BOTH	TCP Port=389,522,1503,1720,1731 UDP Port=53, 161,162, 20	<input type="checkbox"/>

Add Delete Selected Delete All

Apply Reset

The following table describes the labels in this screen.

Table 65 Security > Firewall > IP Filtering Rule

LABEL	DESCRIPTION
IP Filtering Rule	
Enable IP Filtering	Select this check box to enable IP filtering. Define the filter action for the list of MAC addresses in the IP Filtering Table . Select Allow to permit access to the NBG, IP addresses not listed will be denied access to the NBG. Select Deny to block access to the NBG, IP addresses not listed will be allowed to access the NBG.
IP Filtering Table	
NO.	This is the number of an individual IP filtering rule.
PC Description	This field displays a description to identify this rule.
PC IP Address	This field displays the IP address (or a range of IP addresses) of the computer.
Client Service	This field displays the clients services you selected.
Protocol	This field displays the protocol used for the service.
Port Range	This field displays the port number(s).
Select	Select the IP filtering rule which you want to delete.
Add	Click this to add the IP filtering rule.
Delete Selected	Click the Delete Selected button to remove the IP filtering rule which selected from the IP Filtering Table . A window displays asking you to confirm that you want to delete the rule.
Delete All	Click the Delete All button to remove all IP filtering rules from the NBG. A window displays asking you to confirm that you want to delete all rules.
Apply	Click Apply to save your changes back to the NBG.
Reset	Click Reset to start configuring this screen again.

Figure 100 Security > Firewall > IP Filtering Rule: Add

General | **MAC Filtering Rule** | IP Filtering Rule

This page allows users to define service limitation of client PC, including IP address and service type.

Client PC Description :

Client PC IP Address : -

Client Service		
Service Name	Detailed Description	Select
WWW	HTTP, TCP Port 80, 3128, 8000, 8080, 8081	<input type="checkbox"/>
E-mail Sending	SMTP, TCP Port 25	<input type="checkbox"/>
News Forums	NNTP, TCP Port 119	<input type="checkbox"/>
E-mail Receiving	POP3, TCP Port 110	<input type="checkbox"/>
Secure HTTP	HTTPS, TCP Port 443	<input type="checkbox"/>
File Transfer	FTP, TCP Port 21	<input type="checkbox"/>
Telnet Service	TCP Port 23	<input type="checkbox"/>
AIM	AOL Instant Messenger, TCP Port 5190	<input type="checkbox"/>
NetMeeting	H.323, TCP Port 389,522,1503,1720,1731	<input type="checkbox"/>
DNS	UDP Port 53	<input type="checkbox"/>
SNMP	UDP Port 161, 162	<input type="checkbox"/>
VPN-PPTP	TCP Port 1723	<input type="checkbox"/>
VPN-L2TP	UDP Port 1701	<input type="checkbox"/>
TCP	All TCP Port	<input type="checkbox"/>
UDP	All UDP Port	<input type="checkbox"/>

User Define Service

Protocol :

Port Range :

The following table describes the labels in this screen.

Table 66 Security > Firewall > IP Filtering Rule: Add

LABEL	DESCRIPTION
Client PC Description	Enter a name that identifies or describes the firewall rule.
Client PC IP Address	Enter the IP address of the computer for which the IP filtering rule applies.
Client Service	
Service Name	This field displays the services which be provided from clients.
Detailed Description	This field displays the details of Service Name .
Select	Select client services which you want to apply.
User Define Service	
Protocol	Select the transport layer protocol used for the service. Choices are TCP , UDP , or Both .
Port Range	Type a range of port numbers.

Table 66 Security > Firewall > IP Filtering Rule: Add

LABEL	DESCRIPTION
Add	Click Apply to save your changes back to the NBG.
Cancel	Click Cancel to exit this screen without saving.

See [Appendix D on page 225](#) for commonly used services and port numbers.

Content Filter

20.1 Overview

This chapter provides a brief overview of content filtering using the embedded web GUI.

Internet content filtering allows you to create and enforce Internet access policies tailored to your needs. Content filtering is the ability to block certain web features or specific URL keywords.

20.2 What You Can Do

Use the **Content Filter** ([Section 20.4 on page 135](#)) screen to restrict web features, add keywords for blocking and designate a trusted computer.

20.3 What You Need To Know

Content filtering allows you to block certain web features, such as cookies, and/or block access to specific web sites. For example, you can configure one policy that blocks John Doe's access to arts and entertainment web pages.

20.3.1 Content Filtering Profiles

A content filtering profile conveniently stores your custom settings for the following features.

Restrict Web Features

The NBG can disable web proxies and block web features such as ActiveX controls, Java applets and cookies.

Keyword Blocking URL Checking

The NBG checks the URL's domain name (or IP address) and file path separately when performing keyword blocking.

The URL's domain name or IP address is the characters that come before the first slash in the URL. For example, with the URL www.zyxel.com.tw/news/pressroom.php, the domain name is www.zyxel.com.tw.

The file path is the characters that come after the first slash in the URL. For example, with the URL www.zyxel.com.tw/news/pressroom.php, the file path is [news/pressroom.php](http://www.zyxel.com.tw/news/pressroom.php).

Since the NBG checks the URL's domain name (or IP address) and file path separately, it will not find items that go across the two. For example, with the URL www.zyxel.com.tw/news/pressroom.php, the NBG would find "tw" in the domain name (www.zyxel.com.tw). It would also find "news" in the file path ([news/pressroom.php](http://www.zyxel.com.tw/news/pressroom.php)) but it would not find "tw/news".

20.4 Content Filter Screen

Use this screen to restrict web features, add keywords for blocking and designate a trusted computer.

Click **Security** > **Content Filter** to open the **Content Filter** screen.

Figure 101 Security > Content Filter > Content Filter

The following table describes the labels in this screen.

Table 67 Security > Content Filter > Content Filter

LABEL	DESCRIPTION
Enable URL Keyword Blocking	The NBG can block Web sites with URLs that contain certain keywords in the domain name or IP address. For example, if the keyword "bad" was enabled, all sites containing this keyword in the domain name or IP address will be blocked, e.g., URL http://www.website.com/bad.html would be blocked. Select this check box to enable this feature.
Keyword	Type a keyword in this field. You may use any character (up to 64 characters). Wildcards are not allowed. You can also enter a numerical IP address.
Keyword List	This list displays the keywords already added.
Add	Click Add after you have typed a keyword. Repeat this procedure to add other keywords. Up to 64 keywords are allowed. When you try to access a web page containing a keyword, you will get a message telling you that the content filter is blocking this request.
Delete	Highlight a keyword in the lower box and click Delete to remove it. The keyword disappears from the text box after you click Apply .
Clear All	Click this button to remove all of the listed keywords.
Apply	Click Apply to save your changes.
Reset	Click Reset to begin configuring this screen afresh

Bandwidth Management

21.1 Overview

This chapter contains information about configuring bandwidth management and editing rules.

ZyXEL's Bandwidth Management allows you to specify bandwidth management rules based on an application.

In the figure below, uplink traffic goes from the LAN device (**A**) to the WAN device (**B**). Bandwidth management is applied before sending the packets out to the WAN. Downlink traffic comes back from the WAN device (**B**) to the LAN device (**A**). Bandwidth management is applied before sending the traffic out to LAN.

Figure 102 Bandwidth Management Example

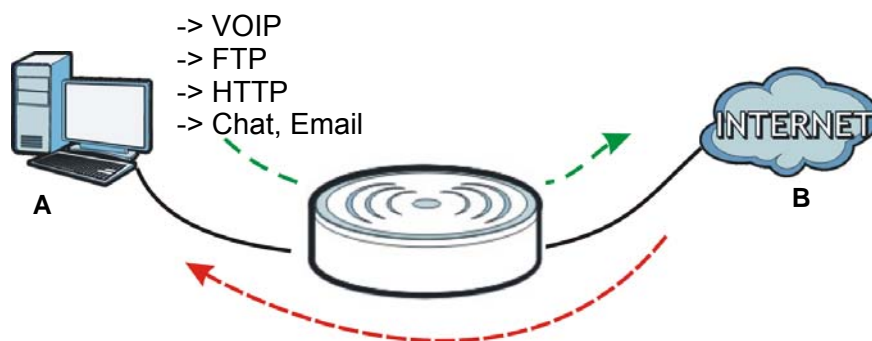

You can allocate specific amounts of bandwidth capacity (bandwidth budgets) to individual applications (like VoIP, Web, FTP, and E-mail for example).

21.2 What You Can Do

- Use the **General** screen ([Section 21.4 on page 137](#)) to enable bandwidth management and assign bandwidth values.
- Use the **Advanced** screen ([Section 21.5 on page 137](#)) to configure bandwidth managements rule for the pre-defined services and applications.

21.3 What You Need To Know

The sum of the bandwidth allotments that apply to the WAN interface (LAN to WAN, WLAN to WAN) must be less than or equal to the **Upstream Bandwidth** that you configure in the **Bandwidth Management Advanced** screen ([Section 21.5 on page 137](#)).

The sum of the bandwidth allotments that apply to the LAN interface (WAN to LAN, WAN to WLAN) must be less than or equal to the **Downstream Bandwidth** that you configure in the **Bandwidth Management Advanced** screen [Section 21.5 on page 137](#).

21.4 General Screen

Use this screen to have the NBG apply bandwidth management.

Click **Management > Bandwidth Management** to open the bandwidth management **General** screen.

Figure 103 Management > Bandwidth Management > General

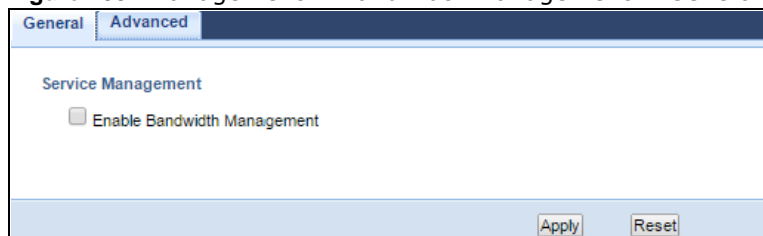

The following table describes the labels in this screen.

Table 68 Management > Bandwidth Management > General

LABEL	DESCRIPTION
Enable Bandwidth Management	This field allows you to have NBG apply bandwidth management. Enable bandwidth management to give traffic that matches a bandwidth rule priority over traffic that does not match a bandwidth rule. Enabling bandwidth management also allows you to control the maximum or minimum amounts of bandwidth that can be used by traffic that matches a bandwidth rule.
Apply	Click Apply to save your customized settings.
Reset	Click Reset to begin configuring this screen afresh.

21.5 Advanced Screen

Use this screen to configure bandwidth management rules for the pre-defined services or applications.

You can also use this screen to configure bandwidth management rule for other services or applications that are not on the pre-defined list of NBG. Additionally, you can define the source and destination IP addresses and port for a service or application.

Note: The two tables shown in this screen can be configured and applied at the same time.

Click **Management > Bandwidth Management > Advanced** to open the bandwidth management **Advanced** screen.

Figure 104 Management > Bandwidth Management > Advanced

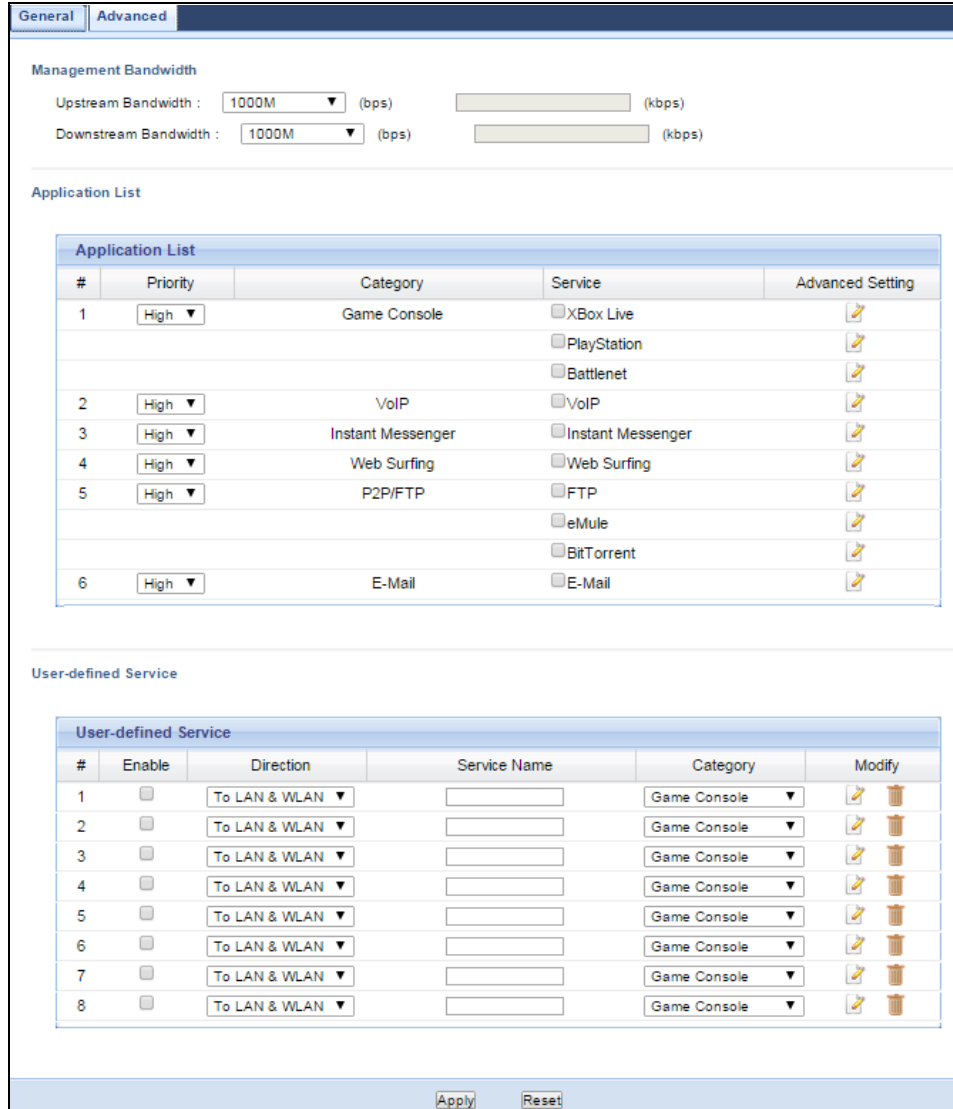

The following table describes the labels in this screen.

Table 69 Management > Bandwidth Management > Advanced

LABEL	DESCRIPTION
Management Bandwidth	
Upstream Bandwidth	Select the total amount of bandwidth (from 64 Kilobits to 50 Megabits) that you want to dedicate to uplink traffic. If you select User Defined , type the total amount of bandwidth that you want to dedicate to uplink (or outgoing) traffic in the (kbps) text box. This is traffic from LAN/WLAN to WAN.

Table 69 Management > Bandwidth Management > Advanced (continued)

LABEL	DESCRIPTION
Downstream Bandwidth	Select the total amount of bandwidth (from 64 Kilobits to 50 Megabits) that you want to dedicate to uplink traffic. If you select User Defined , type the total amount of bandwidth that you want to dedicate to downlink (or incoming) traffic in the (kbps) text box. This is traffic from WAN to LAN/WLAN.
Application List	Use this table to allocate specific amounts of bandwidth based on a pre-defined service.
#	This is the number of an individual bandwidth management rule.
Priority	Select a priority from the drop down list box. Choose High , Mid or Low . <ul style="list-style-type: none"> • High - Select this for voice traffic or video that is especially sensitive to jitter (jitter is the variations in delay). • Mid - Select this for "excellent effort" or better than best effort and would include important business traffic that can tolerate some delay. • Low - Select this for non-critical "background" traffic such as bulk transfers that are allowed but that should not affect other applications and users.
Category	This is the category where a service belongs.
Service	This is the name of the service. Select the check box to have the NBG apply this bandwidth management rule.
Advanced Setting	Click the Edit icon to open the Rule Configuration screen where you can modify the rule.
User-defined Service	Use this table to allocate specific amounts of bandwidth to specific applications or services you specify.
#	This is the number of an individual bandwidth management rule.
Enable	Select this check box to have the NBG apply this bandwidth management rule.
Direction	Select TO LAN/WLAN to apply bandwidth management to traffic from WAN to LAN/WLAN. Select TO WAN to apply bandwidth management to traffic from LAN/WLAN to WAN.
Service Name	Enter a descriptive name for the bandwidth management rule.
Category	This is the category where a service belongs.
Modify	Click the Edit icon to open the Rule Configuration screen. Modify an existing rule or create a new rule in the Rule Configuration screen. See Section 21.5.2 on page 140 for more information. Click the Remove icon to delete a rule.
Apply	Click Apply to save your customized settings.
Reset	Click Reset to begin configuring this screen afresh.

21.5.1 Rule Configuration: Application Rule Configuration

If you want to edit a bandwidth management rule for a pre-defined service or application, click the **Edit** icon in the **Application List** table of the **Advanced** screen. The following screen displays.

Figure 105 Bandwidth Management Rule Configuration: Application List

#	Enable	Direction	Bandwidth	Protocol
0	<input type="checkbox"/>	To LAN & WLAN	Minimum Bandwidth ▼ 10 (kbps)	TCP
1	<input type="checkbox"/>	To LAN & WLAN	Minimum Bandwidth ▼ 10 (kbps)	UDP
2	<input type="checkbox"/>	To WAN	Minimum Bandwidth ▼ 10 (kbps)	TCP
3	<input type="checkbox"/>	To WAN	Minimum Bandwidth ▼ 10 (kbps)	UDP

The following table describes the labels in this screen.

Table 70 Bandwidth Management Rule Configuration: Application List

LABEL	DESCRIPTION
#	This is the number of an individual bandwidth management rule.
Enable	Select an interface's check box to enable bandwidth management on that interface.
Direction	These read-only labels represent the physical interfaces. Bandwidth management applies to all traffic flowing out of the router through the interface, regardless of the traffic's source. Traffic redirect or IP alias may cause LAN-to-LAN traffic to pass through the NBG and be managed by bandwidth management.
Bandwidth	Select Maximum Bandwidth or Minimum Bandwidth and specify the maximum or minimum bandwidth allowed for the rule in kilobits per second.
Protocol	This is the protocol (TCP , UDP or user-defined) used for the service.
OK	Click OK to save your customized settings.
Cancel	Click Cancel to exit this screen without saving.

21.5.2 Rule Configuration: User Defined Service Rule Configuration

If you want to edit a bandwidth management rule for other applications or services, click the **Edit** icon in the **User-defined Service** table of the **Advanced** screen. The following screen displays.

Figure 106 Bandwidth Management Rule Configuration: User-defined Service

The following table describes the labels in this screen

Table 71 Bandwidth Management Rule Configuration: User-defined Service

LABEL	DESCRIPTION
BW Budget	Select Maximum Bandwidth or Minimum Bandwidth and specify the maximum or minimum bandwidth allowed for the rule in kilobits per second.
Destination Address Range	Enter the IP address range of the destination computer. The NBG applies bandwidth management to the service or application that is entering this computer.
Destination Port Range	This is the port number of the destination that define the traffic type, for example TCP port 80 defines web traffic.
Source Address Range	Enter the IP address range of the computer that initializes traffic for the application or service. The NBG applies bandwidth management to traffic initiating from this computer.
Source Port Range	This is the port number of the source that define the traffic type, for example TCP port 80 defines web traffic.
Protocol	Select the protocol (TCP , UDP) for which the bandwidth management rule applies.
Apply	Click Apply to save your customized settings.
Cancel	Click Cancel to exit this screen without saving.

See [Appendix D on page 225](#) for commonly used services and port numbers.

Remote Management

22.1 Overview

This chapter provides information on the Remote Management screens.

Remote Management allows you to manage your NBG from a remote location through the following interfaces:

- LAN and WAN
- LAN only
- WAN only

Note: The NBG is managed using the Web Configurator.

22.2 What You Can Do

Use the **WWW** screen ([Section 22.4 on page 143](#)) to define the interface/s from which the NBG can be managed remotely and specify a secure client that can manage the NBG.

22.3 What You Need to Know

Remote management over LAN or WAN will not work when:

- 1 The IP address in the **Secured Client IP Address** field ([Section 22.4 on page 143](#)) does not match the client IP address. If it does not match, the NBG will disconnect the session immediately.
- 2 There is already another remote management session. You may only have one remote management session running at one time.
- 3 There is a firewall rule that blocks it.

22.3.1 Remote Management and NAT

When NAT is enabled:

- Use the NBG's WAN IP address when configuring from the WAN.
- Use the NBG's LAN IP address when configuring from the LAN.

22.3.2 System Timeout

There is a default system management idle timeout of five minutes (three hundred seconds). The NBG automatically logs you out if the management session remains idle for longer than this timeout period. The management session does not time out when a statistics screen is polling. You can change the timeout period in the **System** screen

22.4 WWW Screen

To change your NBG's remote management settings, click **Management > Remote Management > WWW**.

Figure 107 Management > Remote Management > WWW

The following table describes the labels in this screen

Table 72 Management > Remote Management > WWW

LABEL	DESCRIPTION
Enable Remote WAN Access	Select this check box to enable Remote WAN Access.
Server Port	You may change the server port number for a service if needed, however you must use the same port number in order to use that service for remote management.
Secured Client IP Address	Select All to allow all computes to access the NBG. Otherwise, check Selected and specify the IP address of the computer that can access the NBG.
Apply	Click Apply to save your customized settings and exit this screen.
Reset	Click Reset to begin configuring this screen afresh.

Universal Plug-and-Play (UPnP)

23.1 Overview

This chapter introduces the UPnP feature in the web configurator.

Universal Plug and Play (UPnP) is a distributed, open networking standard that uses TCP/IP for simple peer-to-peer network connectivity between devices. A UPnP device can dynamically join a network, obtain an IP address, convey its capabilities and learn about other devices on the network. In turn, a device can leave a network smoothly and automatically when it is no longer in use.

23.2 What You Can Do

Use the **UPnP** screen ([Section 23.4 on page 145](#)) to enable UPnP on your NBG.

23.3 What You Need to Know

UPnP hardware is identified as an icon in the Network Connections folder (Windows XP). Each UPnP compatible device installed on your network will appear as a separate icon. Selecting the icon of a UPnP device will allow you to access the information and properties of that device.

23.3.1 NAT Traversal

UPnP NAT traversal automates the process of allowing an application to operate through NAT. UPnP network devices can automatically configure network addressing, announce their presence in the network to other UPnP devices and enable exchange of simple product and service descriptions. NAT traversal allows the following:

- Dynamic port mapping
- Learning public IP addresses
- Assigning lease times to mappings

Windows Messenger is an example of an application that supports NAT traversal and UPnP.

See the NAT chapter for more information on NAT.

23.3.2 Cautions with UPnP

The automated nature of NAT traversal applications in establishing their own services and opening firewall ports may present network security issues. Network information and configuration may also be obtained and modified by users in some network environments.

When a UPnP device joins a network, it announces its presence with a multicast message. For security reasons, the NBG allows multicast messages on the LAN only.

All UPnP-enabled devices may communicate freely with each other without additional configuration. Disable UPnP if this is not your intention.

23.4 UPnP Screen

Use this screen to enable UPnP on your NBG.

Click **Management** > **UPnP** to display the screen shown next.

Figure 108 Management > UPnP

The following table describes the fields in this screen.

Table 73 Management > UPnP

LABEL	DESCRIPTION
Enable the Universal Plug and Play (UPnP) Feature	Select this check box to activate UPnP. Be aware that anyone could use a UPnP application to open the web configurator's login screen without entering the NBG's IP address (although you must still enter the password to access the web configurator).
Apply	Click Apply to save the setting to the NBG.
Reset	Click Reset to return to the previously saved settings.

23.5 Technical Reference

The sections show examples of using UPnP.

23.5.1 Using UPnP in Windows XP Example

This section shows you how to use the UPnP feature in Windows XP. You must already have UPnP installed in Windows XP and UPnP activated on the NBG.

Make sure the computer is connected to a LAN port of the NBG. Turn on your computer and the NBG.

23.5.1.1 Auto-discover Your UPnP-enabled Network Device

- 1 Click **start** and **Control Panel**. Double-click **Network Connections**. An icon displays under Internet Gateway.
- 2 Right-click the icon and select **Properties**.

Figure 109 Network Connections



- 3 In the **Internet Connection Properties** window, click **Settings** to see the port mappings there were automatically created.

Figure 110 Internet Connection Properties

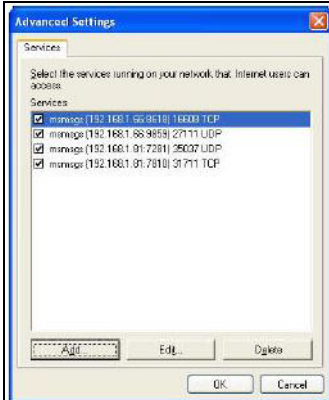
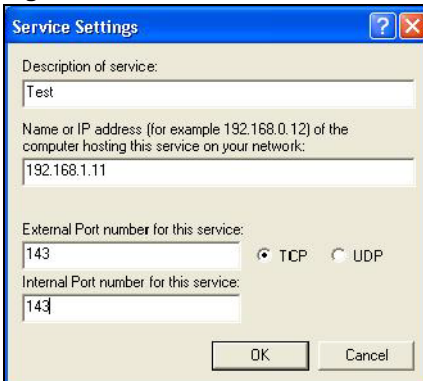

- 4 You may edit or delete the port mappings or click **Add** to manually add port mappings.

Figure 111 Internet Connection Properties: Advanced Settings**Figure 112** Internet Connection Properties: Advanced Settings: Add

Note: When the UPnP-enabled device is disconnected from your computer, all port mappings will be deleted automatically.

- 5 Select **Show icon in notification area when connected** option and click **OK**. An icon displays in the system tray.

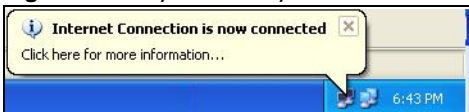
Figure 113 System Tray Icon

- 6 Double-click on the icon to display your current Internet connection status.

Figure 114 Internet Connection Status

23.5.2 Web Configurator Easy Access

With UPnP, you can access the web-based configurator on the NBG without finding out the IP address of the NBG first. This comes helpful if you do not know the IP address of the NBG.

Follow the steps below to access the web configurator.

- 1 Click **Start** and then **Control Panel**.
- 2 Double-click **Network Connections**.
- 3 Select **My Network Places** under **Other Places**.

Figure 115 Network Connections

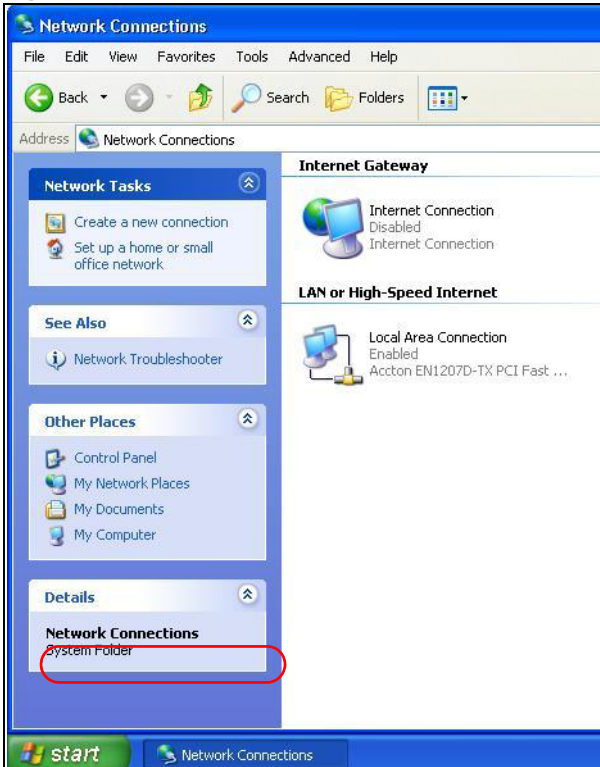

- 4 An icon with the description for each UPnP-enabled device displays under **Local Network**.
- 5 Right-click on the icon for your NBG and select **Invoke**. The web configurator login screen displays.

Figure 116 Network Connections: My Network Places

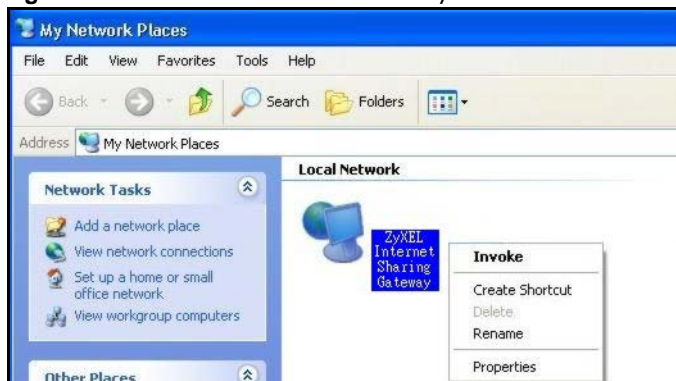

- 6 Right-click on the icon for your NBG and select **Properties**. A properties window displays with basic information about the NBG.

Figure 117 Network Connections: My Network Places: Properties: Example



USB Media Sharing

24.1 Overview

This chapter describes how to configure the media sharing settings on the NBG.

Note: The read and write performance may be affected by amount of file-sharing traffic on your network, type of connected USB device and your USB version (1.1 or 2.0).

Media Server

You can set up your NBG to act as a media server to provide media (like video) to DLNA-compliant players, such as Windows Media Player, ZyXEL DMAs (Digital Media Adapters), Xboxes or PS3s. The media server and clients must have IP addresses in the same subnet.

The NBG media server enables you to:

- Publish all folders for everyone to play media files in the USB storage device connected to the NBG.
- Use hardware-based media clients like the DMA-2500 to play the files.

Note: Anyone on your network can play the media files in the published folders. No user name and password nor other form of security is required.

The following figure is an overview of the NBG's media server feature. DLNA devices **A** and **B** can access and play files on a USB device (**C**) which is connected to the NBG (**D**).

Figure 118 Media Server Overview

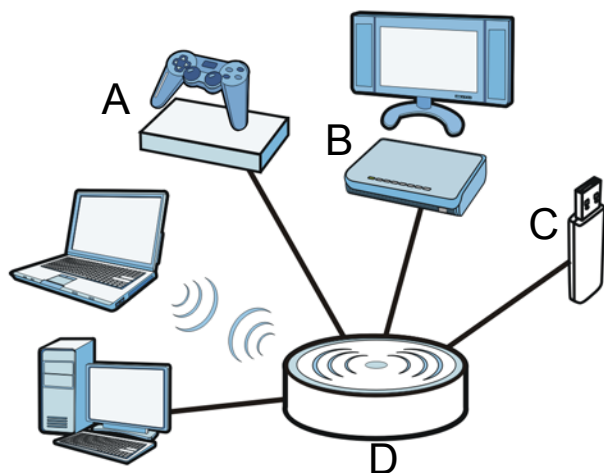

File-Sharing Server

You can also share files on a USB memory stick or hard drive connected to your NBG with users on your network.

The following figure is an overview of the NBG's file-sharing server feature. Computers **A** and **B** can access files on a USB device (**C**) which is connected to the NBG (**D**).

Figure 119 File Sharing Overview

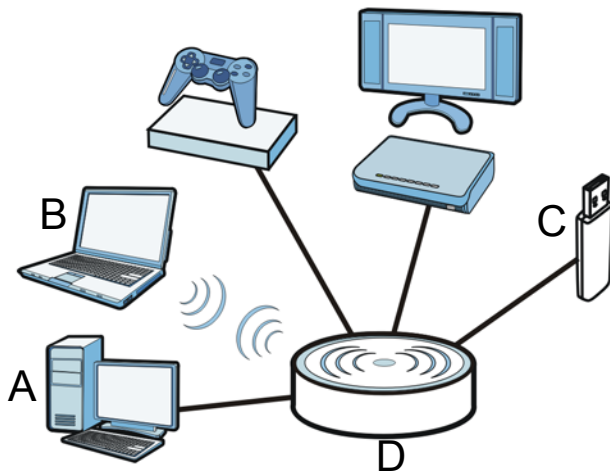

24.2 What You Can Do

- Use the **SMB/CIFS** screen to enable file-sharing via the NBG using Windows Explorer or the workgroup name. This screen also allow you to configure the workgroup name and create user accounts ([Section 24.5 on page 154](#)).
- Use the **DLNA** screen to use the NBG as a media server and allow DLNA-compliant devices to play media files stored in the attached USB device ([Section 24.6 on page 155](#)).
- Use the **FTP** screen to allow file sharing via the NBG using FTP and create user accounts ([Section 24.7 on page 155](#)).

24.3 What You Need To Know

DLNA

The Digital Living Network Alliance (DLNA) is a group of personal computer and electronics companies that works to make products compatible in a home network. DLNA clients play files stored on DLNA servers. The NBG can function as a DLNA-compliant media server and stream files to DLNA-compliant media clients without any configuration.

Workgroup name

This is the name given to a set of computers that are connected on a network and share resources such as a printer or files. Windows automatically assigns the workgroup name when you set up a network.

File Systems

A file system is a way of storing and organizing files on your hard drive and storage device. Often different operating systems such as Windows or Linux have different file systems. The file-sharing feature on your NBG supports New Technology File System (NTFS), File Allocation Table (FAT) and FAT32 file systems.

Windows/CIFS

Common Internet File System (CIFS) is a standard protocol supported by most operating systems in order to share files across the network.

CIFS runs over TCP/IP but uses the SMB (Server Message Block) protocol found in Microsoft Windows for file and printer access; therefore, CIFS will allow all applications, not just Web browsers, to open and share files across the Internet.

The NBG uses Common Internet File System (CIFS) protocol for its file sharing functions. CIFS compatible computers can access the USB file storage devices connected to the NBG. CIFS protocol is supported on Microsoft Windows, Linux Samba and other operating systems (refer to your systems specifications for CIFS compatibility).

Samba

SMB is a client-server protocol used by Microsoft Windows systems for sharing files, printers, and so on.

Samba is a free SMB server that runs on most Unix and Unix-like systems. It provides an implementation of an SMB client and server for use with non-Microsoft operating systems.

File Transfer Protocol

This is a method of transferring data from one computer to another over a network such as the Internet.

24.4 Before You Begin

Make sure the NBG is connected to your network and turned on.

- 1 Connect the USB device to one of the NBG's USB ports.
- 2 The NBG detects the USB device and makes its contents available for browsing. If you are connecting a USB hard drive that comes with an external power supply, make sure it is connected to an appropriate power source that is on.

Note: If your USB device cannot be detected by the NBG, see the troubleshooting for suggestions.

24.5 SMB/CIFS Screen

Use this screen to set up file-sharing via the NBG using Windows Explorer or the workgroup name. You can also configure the workgroup name and create file-sharing user accounts. Click **Management > USB > SMB/CIFS**.

Figure 120 Management > USB > SMB/CIFS

The following table describes the labels in this screen.

Table 74 Management > USB > SMB/CIFS

LABEL	DESCRIPTION
Enable SAMBA	Select this to enable file sharing through the NBG using Windows Explorer or by browsing to your work group.
Server Name	Specify the name to identify the NBG in a work group.
Work Group	You can add the NBG to an existing or a new workgroup on your network. Enter the name of the workgroup which your NBG automatically joins. You can set the NBG's workgroup name to be exactly the same as the workgroup name to which your computer belongs. Note: The NBG will not be able to join the workgroup if your local area network has restrictions set up that do not allow devices to join a workgroup. In this case, contact your network administrator.
User Accounts	Before you can share files you need a user account. Configure the following fields to set up a file-sharing account.
#	This is the index number of the user account.
Enable	This field displays whether a user account is activated or not. Select the check box to enable the account. Clear the check box to disable the account.
User Name	Enter a user name that will be allowed to access the shared files. You can enter up to 20 characters. Only letters and numbers allowed.

Table 74 Management > USB > SMB/CIFS (continued)

LABEL	DESCRIPTION
Password	Enter the password used to access the shared files. You can enter up to 20 characters. Only letters and numbers are allowed. The password is case sensitive.
USB	Specify the user's access rights to the USB storage device which is connected to the NBG's USB port. Read & Write - The user has read and write rights, meaning that the user can create and edit the files on the connected USB device. Read - The user has read rights only and can not create or edit the files on the connected USB device.
Apply	Click Apply to save your changes back to the NBG.
Reset	Click Reset to return to the previously saved settings.

24.6 DLNA Screen

Use this screen to have the NBG act as a DLNA-compliant media server that lets DLNA-compliant media clients on your network play video, music, and photos from the NBG (without having to copy them to another computer). Click **Management > USB > DLNA**.

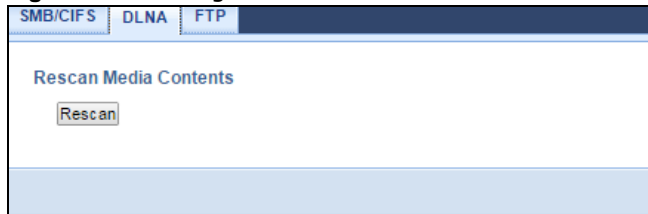
Figure 121 Management > USB > DLNA

Click **Rescan** to have the NBG scan the media files on the connected USB device and do indexing of the file list again so that DLNA clients can find the new files if any.

24.7 FTP Screen

Use this screen to set up file sharing via the NBG using FTP and create user accounts. Click **Management > USB > FTP**.

Figure 122 Management > USB > FTP

The screenshot shows the 'FTP Setup' configuration page. At the top, there are tabs for 'SMB/CIFS', 'DLNA', and 'FTP'. Below the tabs, the 'FTP Setup' section includes a checkbox for 'Enable FTP for WAN' and a 'Port' field with the value '21'. A 'User Accounts' table follows, with columns for '#', 'Enable', 'User Name', 'Password', and 'USB'. The table contains five rows, each with an 'Enable' checkbox, an empty 'User Name' field, an empty 'Password' field, and a 'USB' dropdown menu set to 'Read'. At the bottom of the page are 'Apply' and 'Reset' buttons.

The following table describes the labels in this screen.

Table 75 Management > USB > FTP

LABEL	DESCRIPTION
Enable FTP for WAN	Select this to enable the FTP server on the NBG for file sharing using FTP.
Port	You may change the server port number for FTP if needed, however you must use the same port number in order to use that service for file sharing.
User Accounts	Before you can share files you need a user account. Configure the following fields to set up a file-sharing account.
#	This is the index number of the user account.
Enable	This field displays whether a user account is activated or not. Select the check box to enable the account. Clear the check box to disable the account.
User Name	Enter a user name that will be allowed to access the shared files. You can enter up to 20 characters. Only letters and numbers allowed.
Password	Enter the password used to access the shared files. You can enter up to 20 characters. Only letters and numbers are allowed. The password is case sensitive.
USB	Specify the user's access rights to the USB storage device which is connected to the NBG's USB port. Read & Write - The user has read and write rights, meaning that the user can create and edit the files on the connected USB device. Read - The user has read rights only and can not create or edit the files on the connected USB device.
Apply	Click Apply to save your changes back to the NBG.
Reset	Click Reset to return to the previously saved settings.

24.8 Example of Accessing Your Shared Files From a Computer

You can use Windows Explorer or FTP to access the USB storage devices connected to the NBG.

This example shows you how to use Microsoft's Windows XP to browse your shared files. Refer to your operating system's documentation for how to browse your file structure.

24.8.1 Use Windows Explorer to Share Files

You should have enabled file sharing and created a user account (Bob/1234 for example) with read and write access to USB in the **USB > SMB/CIFS** screen.

Open Windows Explorer to access the connected USB device using either Windows Explorer browser or by browsing to your workgroup.

- 1 In Windows Explorer's Address bar type a double backslash "\\\" followed by the IP address of the NBG (the default IP address of the NBG in router mode is 192.168.1.1) and press [ENTER]. A screen asking for password authentication appears. Type the user name and password (Bob and 1234 in this example) and click **OK**.

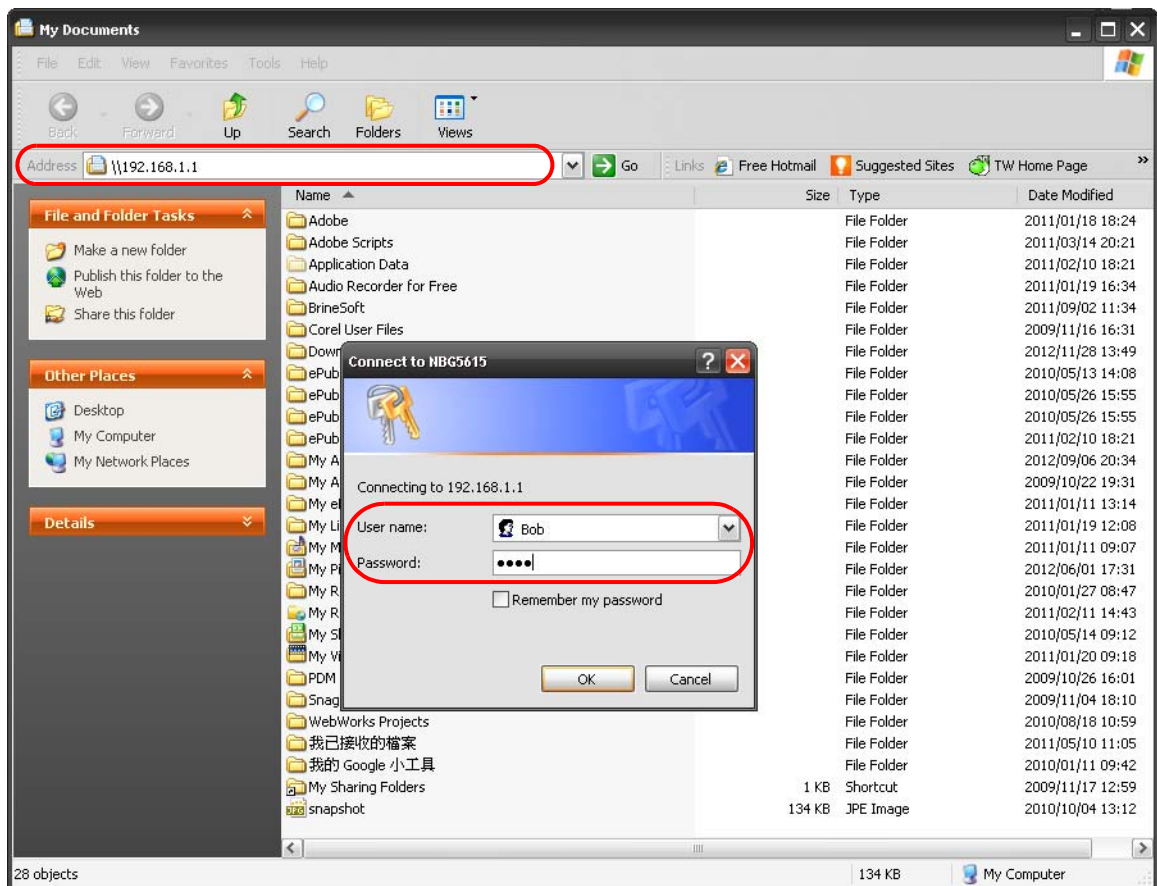

Note: Once you log into the shared folder via your NBG, you do not have to relogin unless you restart your computer.

- You can also use the workgroup name to access files by browsing to the workgroup folder using the folder tree on the left side of the screen. It is located under **My Network Places**. In this example the workgroup name is the default "Workgroup".

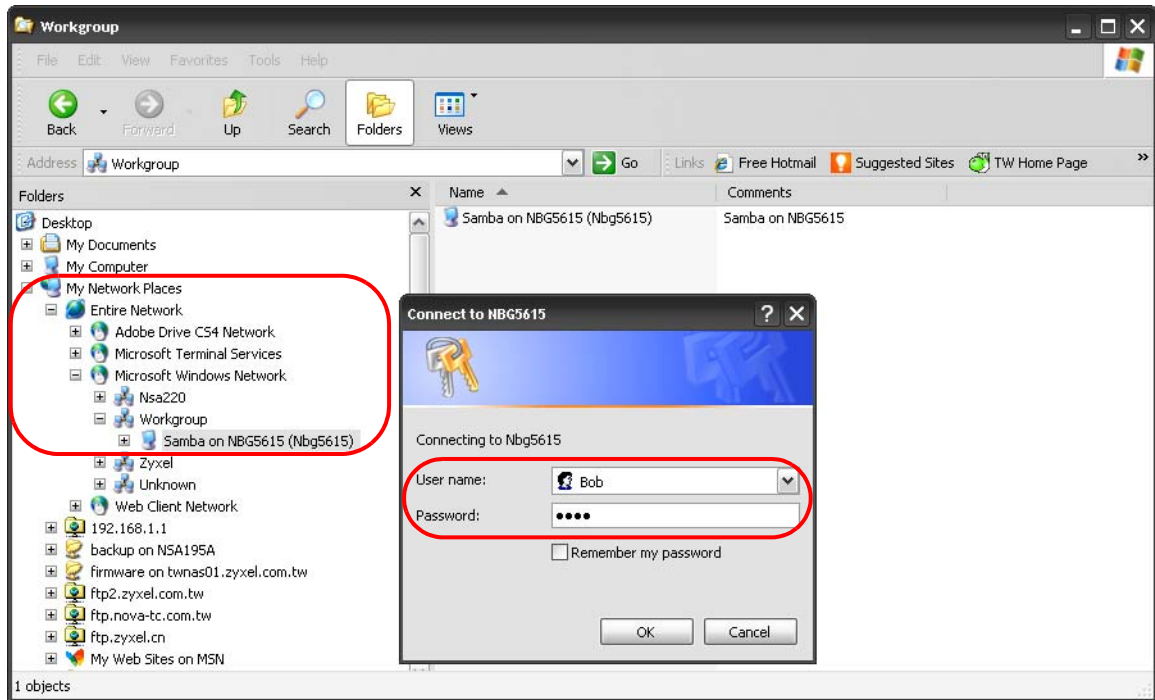

24.8.2 Use FTP to Share Files

You can use FTP to access the USB storage devices connected to the NBG. In this example, we use the web browser to share files via FTP from the LAN. The way or screen you log into the FTP server (on the NBG) varies depending on your FTP client. See your FTP client documentation for more information.

You should have enabled file sharing and created a user account (Bob/1234 for example) with read and write access to USB in the **USB > FTP** screen.

- In your web browser's address or URL bar type "ftp://" followed by the IP address of the NBG (the default LAN IP address of the NBG in router mode is 192.168.1.1) and click **Go** or press [ENTER].

- 2 A screen asking for password authentication appears. Enter the user name and password (you configured in the **USB > FTP** screen) and click **Log On**.

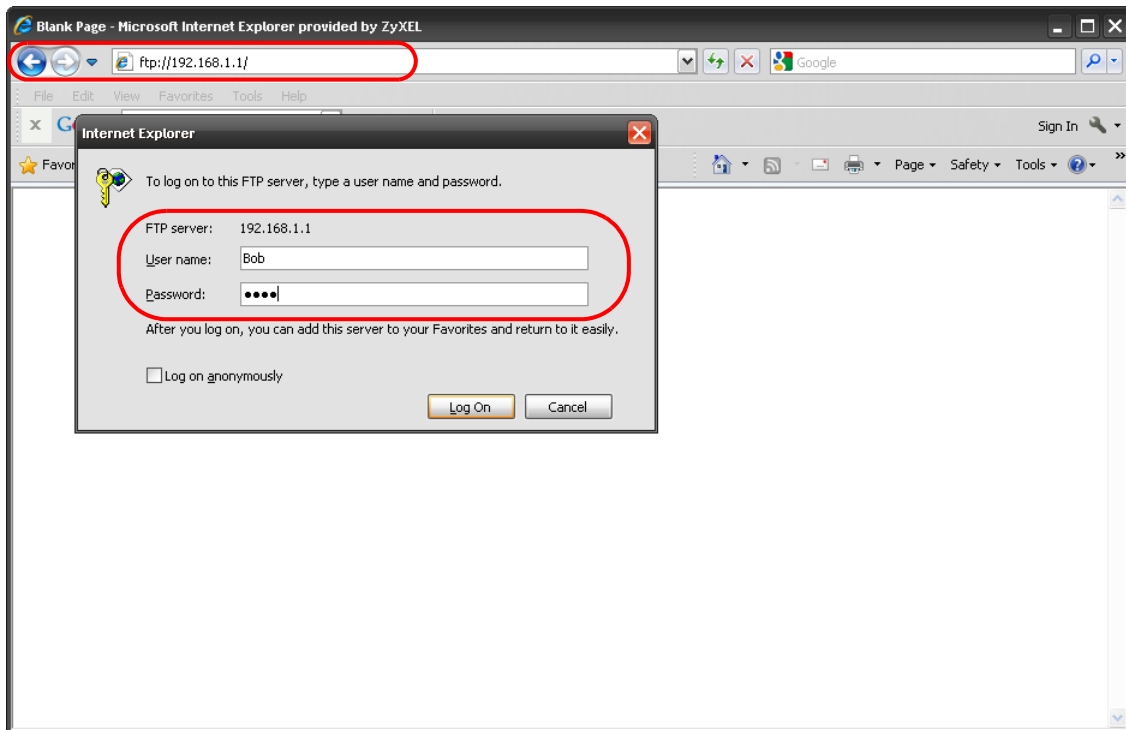

- 3 The screen changes and shows you the folder for the USB storage device connected to your NBG. Double-click the folder to display the contents in it.



Maintenance

25.1 Overview

This chapter provides information on the **Maintenance** screens.

25.2 What You Can Do

- Use the **General** screen to configure system and domain name. You can also set the timeout period of the management session ([Section 25.3 on page 160](#)).
- Use the **Password** screen to change your NBG's system password ([Section 25.4 on page 161](#)).
- Use the **Time** screen to change your NBG's time and date ([Section 25.5 on page 162](#)).
- Use the **Firmware Upgrade** screen to upload firmware to your NBG ([Section 25.6 on page 163](#)).
- Use the **Backup/Restore** screen to view information related to factory defaults, backup configuration, and restoring configuration ([Section 25.8 on page 166](#)).
- Use the **Restart** screen to reboot the NBG without turning the power off ([Section 25.8 on page 166](#)).

25.3 General Screen

Use this screen to set the configure system and domain name as well as management session timeout period. Click **Maintenance > General**. The following screen displays.

Figure 123 Maintenance > General

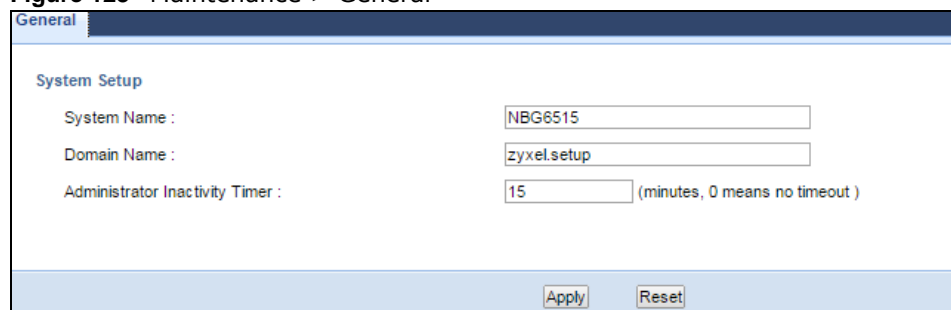

The screenshot shows the 'General' configuration screen for the NBG6515. It features a 'System Setup' section with three input fields: 'System Name' (containing 'NBG6515'), 'Domain Name' (containing 'zyxel.setup'), and 'Administrator Inactivity Timer' (containing '15' with a note '(minutes, 0 means no timeout)'). At the bottom right, there are 'Apply' and 'Reset' buttons.

The following table describes the labels in this screen.

Table 76 Maintenance > General

LABEL	DESCRIPTION
System Setup	
System Name	System Name is a unique name to identify the NBG in an Ethernet network.
Domain Name	Enter the domain name you want to give to the NBG.
Administrator Inactivity Timer	Type how many minutes a management session can be left idle before the session times out. The default is 5 minutes. After it times out you have to log in with your password again. Very long idle timeouts may have security risks. A value of "0" means a management session never times out, no matter how long it has been left idle (not recommended).
Apply	Click Apply to save your changes back to the NBG.
Reset	Click Reset to return to the previously saved settings.

25.4 Password Screen

It is strongly recommended that you change your NBG's password.

If you forget your NBG's password (or IP address), you will need to reset the device. See [Section 25.8 on page 166](#) for details.

Click **Maintenance > Password**. The screen appears as shown.

Figure 124 Maintenance > Password

The following table describes the labels in this screen.

Table 77 Maintenance > Password

LABEL	DESCRIPTION
Password Setup	Change your NBG's password (recommended) using the fields as shown.
Old Password	Type the default password or the existing password you use to access the system in this field.
New Password	Type your new system password (up to 30 characters). Note that as you type a password, the screen displays an asterisk (*) for each character you type.
Retype to Confirm	Type the new password again in this field.
Apply	Click Apply to save your changes back to the NBG.
Reset	Click Reset to begin configuring this screen afresh.

25.5 Time Setting Screen

Use this screen to configure the NBG's time based on your local time zone. To change your NBG's time and date, click **Maintenance > Time**. The screen appears as shown.

Figure 125 Maintenance > Time

The following table describes the labels in this screen.

Table 78 Maintenance > Time

LABEL	DESCRIPTION
Current Time and Date	
Current Time	This field displays the time of your NBG. Each time you reload this page, the NBG synchronizes the time with the time server.
Current Date	This field displays the date of your NBG. Each time you reload this page, the NBG synchronizes the date with the time server.
Current Time and Date	
Manual	Select this radio button to enter the time and date manually. If you configure a new time and date, Time Zone and Daylight Saving at the same time, the new time and date you entered has priority and the Time Zone and Daylight Saving settings do not affect it.
New Time (hh:mm:ss)	This field displays the last updated time from the time server or the last time configured manually. When you select Manual , enter the new time in this field and then click Apply .
New Date (yyyy/mm/dd)	This field displays the last updated date from the time server or the last date configured manually. When you select Manual , enter the new date in this field and then click Apply .

Table 78 Maintenance > Time (continued)

LABEL	DESCRIPTION
Get from Time Server	Select this radio button to have the NBG get the time and date from the time server you specified below.
Auto	Select Auto to have the NBG automatically search for an available time server and synchronize the date and time with the time server after you click Apply .
User Defined Time Server Address	Select User Defined Time Server Address and enter the IP address or URL (up to 20 extended ASCII characters in length) of your time server. Check with your ISP/network administrator if you are unsure of this information.
Time Zone Setup	
Time Zone	Choose the time zone of your location. This will set the time difference between your time zone and Greenwich Mean Time (GMT).
Daylight Savings	Daylight saving is a period from late spring to early fall when many countries set their clocks ahead of normal local time by one hour to give more daytime light in the evening. Select this option if you use Daylight Saving Time.
Start Date (mm/dd)	Configure the day and time when Daylight Saving Time starts if you selected Daylight Savings . The o'clock field uses the 24 hour format. Here are a couple of examples: Daylight Saving Time starts in most parts of the United States on the first Sunday of April. Each time zone in the United States starts using Daylight Saving Time at 2 A.M. local time. So in the United States you would select First, Sunday, April and select 2 in the o'clock field. Daylight Saving Time starts in the European Union on the last Sunday of March. All of the time zones in the European Union start using Daylight Saving Time at the same moment (1 A.M. GMT or UTC). So in the European Union you would select Last, Sunday, March . The time you select in the o'clock field depends on your time zone. In Germany for instance, you would select 2 because Germany's time zone is one hour ahead of GMT or UTC (GMT+1).
End Date	Configure the day and time when Daylight Saving Time ends if you selected Daylight Savings . The o'clock field uses the 24 hour format. Here are a couple of examples: Daylight Saving Time ends in the United States on the last Sunday of October. Each time zone in the United States stops using Daylight Saving Time at 2 A.M. local time. So in the United States you would select Last, Sunday, October and select 2 in the o'clock field. Daylight Saving Time ends in the European Union on the last Sunday of October. All of the time zones in the European Union stop using Daylight Saving Time at the same moment (1 A.M. GMT or UTC). So in the European Union you would select Last, Sunday, October . The time you select in the o'clock field depends on your time zone. In Germany for instance, you would select 2 because Germany's time zone is one hour ahead of GMT or UTC (GMT+1).
Apply	Click Apply to save your changes back to the NBG.
Reset	Click Reset to begin configuring this screen afresh.

25.6 Firmware Upgrade Screen

Find firmware at www.zyxel.com in a file that (usually) uses the system model name with a "*.bin" extension, e.g., "NBG.bin". The upload process uses HTTP (Hypertext Transfer Protocol) and may take up to two minutes. After a successful upload, the system will reboot.

Click **Maintenance > Firmware Upgrade**. Follow the instructions in this screen to upload firmware to your NBG.

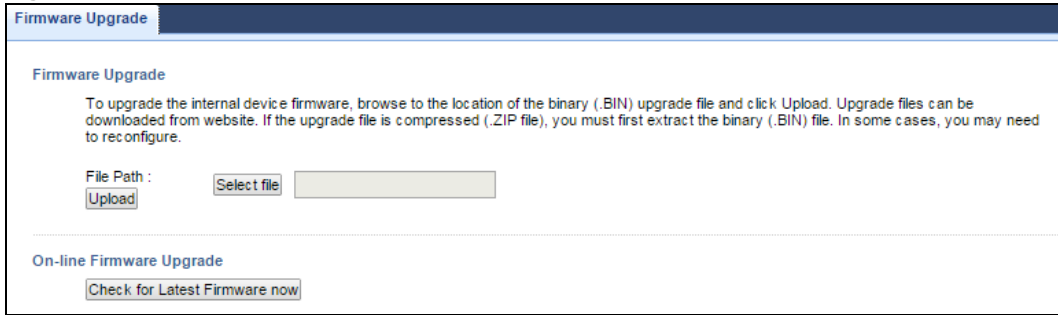
Figure 126 Maintenance > Firmware Upgrade

The following table describes the labels in this screen.

Table 79 Maintenance > Firmware Upgrade

LABEL	DESCRIPTION
File Path	Type in the location of the file you want to upload in this field or click Select file to find it.
Select file	Click Select file to find the .bin file you want to upload. Remember that you must decompress compressed (.zip) files before you can upload them.
Upload	Click Upload to begin the upload process. This process may take up to two minutes.
Check for Latest Firmware Now	Click this to check for the latest updated firmware.

Note: Do not turn off the NBG while firmware upload is in progress!

After you see the **Firmware Upload In Process** screen, wait two minutes before logging into the NBG again.

The NBG automatically restarts in this time causing a temporary network disconnect. In some operating systems, you may see the following icon on your desktop.

Figure 127 Network Temporarily Disconnected

After two minutes, log in again and check your new firmware version in the **Status** screen.

If the upload was not successful, an error message appears. Click **Return** to go back to the **Firmware Upgrade** screen.

25.7 Configuration Backup/Restore Screen

Backup configuration allows you to back up (save) the NBG's current configuration to a file on your computer. Once your NBG is configured and functioning properly, it is highly recommended that you back up your configuration file before making configuration changes. The backup configuration file will be useful in case you need to return to your previous settings.

Restore configuration allows you to upload a new or previously saved configuration file from your computer to your NBG.

Click **Maintenance > Backup/Restore**. Information related to factory defaults, backup configuration, and restoring configuration appears as shown next.

Figure 128 Maintenance > Backup/Restore

Backup Restore

Backup Configuration

Click **Backup** to save the current configuration of your system to your computer. **Backup**

Restore Configuration

To restore a previously saved configuration file to your system, browse to the location of the configuration file and click **Upload**.

File Path : **Select file** No file selected. **Upload**

Back to Factory Defaults

Click **Reset** to clear all user-entered configuration information and return to factory defaults. After resetting, the

- Password will be 1234
- LAN IP address will be 192.168.3.1
- DHCP will be reset to server

Reset

The following table describes the labels in this screen.

Table 80 Maintenance > Backup/Restore

LABEL	DESCRIPTION
Backup	Click Backup to save the NBG's current configuration to your computer.
File Path	Type in the location of the file you want to upload in this field or click Browse... to find it.
Select file	Click Select file to find the file you want to upload. Remember that you must decompress compressed (.ZIP) files before you can upload them.
Upload	Click Upload to begin the upload process. Note: Do not turn off the NBG while configuration file upload is in progress. After you see a "configuration upload successful" screen, you must then wait one minute before logging into the NBG again. The NBG automatically restarts in this time causing a temporary network disconnect. If you see an error screen, click Back to return to the Backup/Restore screen.
Reset	Pressing the Reset button in this section clears all user-entered configuration information and returns the NBG to its factory defaults. You can also press the RESET button on the rear panel to reset the factory defaults of your NBG. Refer to the chapter about introducing the Web Configurator for more information on the RESET button.

Note: If you uploaded the default configuration file you may need to change the IP address of your computer to be in the same subnet as that of the default NBG IP address (192.168.1.2). See [Appendix B on page 184](#) for details on how to set up your computer's IP address.

25.8 Restart Screen

System restart allows you to reboot the NBG without turning the power off.

Click **Maintenance** > **Restart** to open the following screen.

Figure 129 Maintenance > Restart

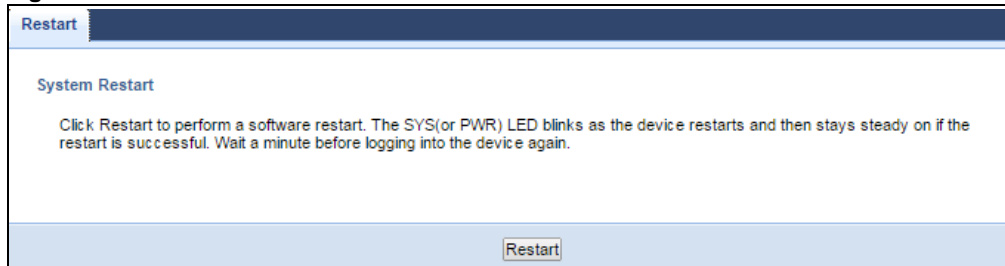

Click **Restart** to have the NBG reboot. This does not affect the NBG's configuration.

Troubleshooting

This chapter offers some suggestions to solve problems you might encounter. The potential problems are divided into the following categories.

- [Power, Hardware Connections, and LEDs](#)
- [NBG Access and Login](#)
- [Internet Access](#)
- [Resetting the NBG to Its Factory Defaults](#)
- [Wireless Router/AP Troubleshooting](#)
- [USB Device Problems](#)

26.1 Power, Hardware Connections, and LEDs

The NBG does not turn on. None of the LEDs turn on.

- 1 Make sure you are using the power adaptor or cord included with the NBG.
- 2 Make sure the power adaptor or cord is connected to the NBG and plugged in to an appropriate power source. Make sure the power source is turned on.
- 3 Disconnect and re-connect the power adaptor or cord to the NBG.
- 4 If the problem continues, contact the vendor.

One of the LEDs does not behave as expected.

- 1 Make sure you understand the normal behavior of the LED. See [Section 1.5 on page 14](#).
- 2 Check the hardware connections. See the Quick Start Guide.
- 3 Inspect your cables for damage. Contact the vendor to replace any damaged cables.
- 4 Disconnect and re-connect the power adaptor to the NBG.
- 5 If the problem continues, contact the vendor.

26.2 NBG Access and Login

I don't know the IP address of my NBG.

- 1 The default IP address is **192.168.1.1**.
- 2 If you changed the IP address and have forgotten it, you might get the IP address of the NBG by looking up the IP address of the default gateway for your computer. To do this in most Windows computers, click **Start > Run**, enter **cmd**, and then enter **ipconfig**. The IP address of the **Default Gateway** might be the IP address of the NBG (it depends on the network), so enter this IP address in your Internet browser. Set your device to **Router Mode**, login (see the Quick Start Guide for instructions) and go to the **Device Information** table in the **Status** screen. Your NBG's IP address is available in the **Device Information** table.
 - If the **DHCP** setting under **LAN information** is **None**, your device has a fixed IP address.
 - If the **DHCP** setting under **LAN information** is **Client**, then your device receives an IP address from a DHCP server on the network.
- 3 If your NBG is a DHCP client, you can find your IP address from the DHCP server. This information is only available from the DHCP server which allocates IP addresses on your network. Find this information directly from the DHCP server or contact your system administrator for more information.
- 4 Reset your NBG to change all settings back to their default. This means your current settings are lost. See [Section 26.4 on page 171](#) in the **Troubleshooting** for information on resetting your NBG.

I forgot the password.

- 1 The default password is **1234**.
- 2 If this does not work, you have to reset the device to its factory defaults. See [Section 26.4 on page 171](#).

I cannot see or access the **Login** screen in the Web Configurator.

- 1 Make sure you are using the correct IP address.
 - The default IP address is [192.168.1.1](#).
 - If you changed the IP address ([Section 14.4 on page 112](#)), use the new IP address.
 - If you changed the IP address and have forgotten it, see the troubleshooting suggestions for [I don't know the IP address of my NBG](#).
- 2 Check the hardware connections, and make sure the LEDs are behaving as expected. See the Quick Start Guide.

- 3 Make sure your Internet browser does not block pop-up windows and has JavaScript and Java enabled. See [Appendix A on page 173](#).
- 4 Make sure your computer is in the same subnet as the NBG. (If you know that there are routers between your computer and the NBG, skip this step.)
 - If there is a DHCP server on your network, make sure your computer is using a dynamic IP address. See [Appendix B on page 184](#).
 - If there is no DHCP server on your network, make sure your computer's IP address is in the same subnet as the NBG. See [Appendix B on page 184](#).
- 5 Reset the device to its factory defaults, and try to access the NBG with the default IP address. See [Section 3.3 on page 30](#).
- 6 If the problem continues, contact the network administrator or vendor, or try one of the advanced suggestions.

Advanced Suggestion

- If your computer is connected to the **WAN** port or is connected wirelessly, use a computer that is connected to a **LAN/ETHERNET** port.

I can see the **Login** screen, but I cannot log in to the NBG.

- 1 Make sure you have entered the password correctly. The default password is **1234**. This field is case-sensitive, so make sure [Caps Lock] is not on.
- 2 This can happen when you fail to log out properly from your last session. Try logging in again after 5 minutes.
- 3 Disconnect and re-connect the power adaptor or cord to the NBG.
- 4 If this does not work, you have to reset the device to its factory defaults. See [Section 26.4 on page 171](#).

26.3 Internet Access

I cannot access the Internet.

- 1 Check the hardware connections, and make sure the LEDs are behaving as expected. See the Quick Start Guide.
- 2 Make sure you entered your ISP account information correctly in the wizard. These fields are case-sensitive, so make sure [Caps Lock] is not on.

- 3 If you are trying to access the Internet wirelessly, make sure the wireless settings in the wireless client are the same as the settings in the AP.
- 4 Disconnect all the cables from your device, and follow the directions in the Quick Start Guide again.
- 5 Check your System Operation Mode setting.
 - Select **Router** if your device routes traffic between a local network and another network such as the Internet.
 - Select **Access Point** if your device bridges traffic between clients on the same network.
 - Select **Universal Repeater Mode** if your device is wirelessly connected to an access point or wireless router with Internet access. Your computer should be set to obtain a dynamic IP address.
- 6 Disconnect all the cables from your device, and follow the directions in the Quick Start Guide again.
- 7 If the problem continues, contact your ISP.

I cannot access the Internet anymore. I had access to the Internet (with the NBG), but my Internet connection is not available anymore.

- 1 Check the hardware connections, and make sure the LEDs are behaving as expected. See the Quick Start Guide and [Section 1.5 on page 14](#).
- 2 Reboot the NBG.
- 3 If the problem continues, contact your ISP.

The Internet connection is slow or intermittent.

- 1 There might be a lot of traffic on the network. Look at the LEDs, and check [Section 1.5 on page 14](#). If the NBG is sending or receiving a lot of information, try closing some programs that use the Internet, especially peer-to-peer applications.
- 2 Check the signal strength. If the signal strength is low, try moving the NBG closer to the AP if possible, and look around to see if there are any devices that might be interfering with the wireless network (for example, microwaves, other wireless networks, and so on).
- 3 Reboot the NBG.
- 4 If the problem continues, contact the network administrator or vendor, or try one of the advanced suggestions.

Advanced Suggestions

- Check the settings for bandwidth management. If it is disabled, you might consider activating it. If it is enabled, you might consider changing the allocations.

- Check the settings for QoS. If it is disabled, you might consider activating it. If it is enabled, you might consider raising or lowering the priority for some applications.

I set up URL keyword blocking, but I can still access a website that should be blocked.

Make sure that you select the **Enable URL Keyword Blocking** check box in the Content Filtering screen. Make sure that the keywords that you type are listed in the **Keyword List**.

If a keyword that is listed in the **Keyword List** is not blocked when it is found in a URL, customize the keyword blocking using commands. See the Customizing Keyword Blocking URL Checking section in the Content Filter chapter.

26.4 Resetting the NBG to Its Factory Defaults

If you reset the NBG, you lose all of the changes you have made. The NBG re-loads its default settings, and the password resets to **1234**. You have to make all of your changes again.

You will lose all of your changes when you push the **RESET** button.

To reset the NBG,

- 1 Make sure the power LED is on.
- 2 Press the **RESET** button for longer than 1 second to restart/reboot the NBG.
- 3 Press the **RESET** button for longer than five seconds to set the NBG back to its factory-default configurations.

If the NBG restarts automatically, wait for the NBG to finish restarting, and log in to the Web Configurator. The password is "1234".

If the NBG does not restart automatically, disconnect and reconnect the NBG's power. Then, follow the directions above again.

26.5 Wireless Router/AP Troubleshooting

I cannot access the NBG or ping any computer from the WLAN (wireless AP or router).

- 1 Make sure the wireless LAN is enabled on the NBG

- 2 Make sure the wireless adapter on the wireless station is working properly.
- 3 Make sure the wireless adapter installed on your computer is IEEE 802.11 compatible and supports the same wireless standard as the NBG.
- 4 Make sure your computer (with a wireless adapter installed) is within the transmission range of the NBG.
- 5 Check that both the NBG and your wireless station are using the same wireless and wireless security settings.
- 6 Make sure traffic between the WLAN and the LAN is not blocked by the firewall on the NBG.
- 7 Make sure you allow the NBG to be remotely accessed through the WLAN interface. Check your remote management settings.
 - See the chapter on Wireless LAN in the User's Guide for more information.

I cannot access the Web Configurator after I switched to AP mode.

192.168.1.1 is the default IP in Router mode (the default mode). In AP mode the default IP is 192.168.1.2. So, when you switch from Router mode to AP mode, you need to use the AP mode IP to log in.

26.6 USB Device Problems

I cannot access or see a USB device that is connected to the NBG.

- 1 Be sure to install the ZyXEL NetUSB Share Center Utility (for NetUSB functionality) first from the included disc, or download the latest version from the zyxel.com website.
- 2 Disconnect the problematic USB device, then reconnect it to the NBG.
- 3 Ensure that the USB device has power.
- 4 Check your cable connections.
- 5 Restart the NBG by disconnecting the power and then reconnecting it.
- 6 If the USB device requires a special driver, install the driver from the installation disc that came with the device. After driver installation, reconnect the USB device to the NBG and try to connect to it again with your computer.
- 7 If the problem persists, contact your vendor.

What kind of USB devices do the NBG support?

- 1 It is strongly recommended to use version 2.0 or lower USB storage devices (such as memory sticks, USB hard drives) and/or USB devices (such as USB printers). Other USB products are not guaranteed to function properly with the NBG.

IP Addresses and Subnetting

This appendix introduces IP addresses and subnet masks.

IP addresses identify individual devices on a network. Every networking device (including computers, servers, routers, printers, etc.) needs an IP address to communicate across the network. These networking devices are also known as hosts.

Subnet masks determine the maximum number of possible hosts on a network. You can also use subnet masks to divide one network into multiple sub-networks.

Introduction to IP Addresses

One part of the IP address is the network number, and the other part is the host ID. In the same way that houses on a street share a common street name, the hosts on a network share a common network number. Similarly, as each house has its own house number, each host on the network has its own unique identifying number - the host ID. Routers use the network number to send packets to the correct network, while the host ID determines to which host on the network the packets are delivered.

Structure

An IP address is made up of four parts, written in dotted decimal notation (for example, 192.168.1.1). Each of these four parts is known as an octet. An octet is an eight-digit binary number (for example 11000000, which is 192 in decimal notation).

Therefore, each octet has a possible range of 00000000 to 11111111 in binary, or 0 to 255 in decimal.

The following figure shows an example IP address in which the first three octets (192.168.1) are the network number, and the fourth octet (16) is the host ID.

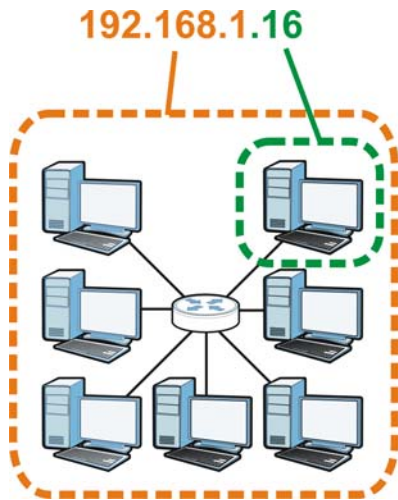
Figure 130 Network Number and Host ID

How much of the IP address is the network number and how much is the host ID varies according to the subnet mask.

Subnet Masks

A subnet mask is used to determine which bits are part of the network number, and which bits are part of the host ID (using a logical AND operation). The term “subnet” is short for “sub-network”.

A subnet mask has 32 bits. If a bit in the subnet mask is a “1” then the corresponding bit in the IP address is part of the network number. If a bit in the subnet mask is “0” then the corresponding bit in the IP address is part of the host ID.

The following example shows a subnet mask identifying the network number (in bold text) and host ID of an IP address (192.168.1.2 in decimal).

Table 81 IP Address Network Number and Host ID Example

	1ST OCTET: (192)	2ND OCTET: (168)	3RD OCTET: (1)	4TH OCTET (2)
IP Address (Binary)	11000000	10101000	00000001	00000010
Subnet Mask (Binary)	11111111	11111111	11111111	00000000
Network Number	11000000	10101000	00000001	
Host ID				00000010

By convention, subnet masks always consist of a continuous sequence of ones beginning from the leftmost bit of the mask, followed by a continuous sequence of zeros, for a total number of 32 bits.

Subnet masks can be referred to by the size of the network number part (the bits with a “1” value). For example, an “8-bit mask” means that the first 8 bits of the mask are ones and the remaining 24 bits are zeroes.

Subnet masks are expressed in dotted decimal notation just like IP addresses. The following examples show the binary and decimal notation for 8-bit, 16-bit, 24-bit and 29-bit subnet masks.

Table 82 Subnet Masks

	BINARY				DECIMAL
	1ST OCTET	2ND OCTET	3RD OCTET	4TH OCTET	
8-bit mask	11111111	00000000	00000000	00000000	255.0.0.0
16-bit mask	11111111	11111111	00000000	00000000	255.255.0.0
24-bit mask	11111111	11111111	11111111	00000000	255.255.255.0
29-bit mask	11111111	11111111	11111111	11111000	255.255.255.248

Network Size

The size of the network number determines the maximum number of possible hosts you can have on your network. The larger the number of network number bits, the smaller the number of remaining host ID bits.

An IP address with host IDs of all zeros is the IP address of the network (192.168.1.0 with a 24-bit subnet mask, for example). An IP address with host IDs of all ones is the broadcast address for that network (192.168.1.255 with a 24-bit subnet mask, for example).

As these two IP addresses cannot be used for individual hosts, calculate the maximum number of possible hosts in a network as follows:

Table 83 Maximum Host Numbers

SUBNET MASK		HOST ID SIZE		MAXIMUM NUMBER OF HOSTS
8 bits	255.0.0.0	24 bits	$2^{24} - 2$	16777214
16 bits	255.255.0.0	16 bits	$2^{16} - 2$	65534
24 bits	255.255.255.0	8 bits	$2^8 - 2$	254
29 bits	255.255.255.248	3 bits	$2^3 - 2$	6

Notation

Since the mask is always a continuous number of ones beginning from the left, followed by a continuous number of zeros for the remainder of the 32 bit mask, you can simply specify the number of ones instead of writing the value of each octet. This is usually specified by writing a "/" followed by the number of bits in the mask after the address.

For example, 192.1.1.0 /25 is equivalent to saying 192.1.1.0 with subnet mask 255.255.255.128.

The following table shows some possible subnet masks using both notations.

Table 84 Alternative Subnet Mask Notation

SUBNET MASK	ALTERNATIVE NOTATION	LAST OCTET (BINARY)	LAST OCTET (DECIMAL)
255.255.255.0	/24	0000 0000	0
255.255.255.128	/25	1000 0000	128
255.255.255.192	/26	1100 0000	192

Table 84 Alternative Subnet Mask Notation (continued)

SUBNET MASK	ALTERNATIVE NOTATION	LAST OCTET (BINARY)	LAST OCTET (DECIMAL)
255.255.255.224	/27	1110 0000	224
255.255.255.240	/28	1111 0000	240
255.255.255.248	/29	1111 1000	248
255.255.255.252	/30	1111 1100	252

Subnetting

You can use subnetting to divide one network into multiple sub-networks. In the following example a network administrator creates two sub-networks to isolate a group of servers from the rest of the company network for security reasons.

In this example, the company network address is 192.168.1.0. The first three octets of the address (192.168.1) are the network number, and the remaining octet is the host ID, allowing a maximum of $2^8 - 2$ or 254 possible hosts.

The following figure shows the company network before subnetting.

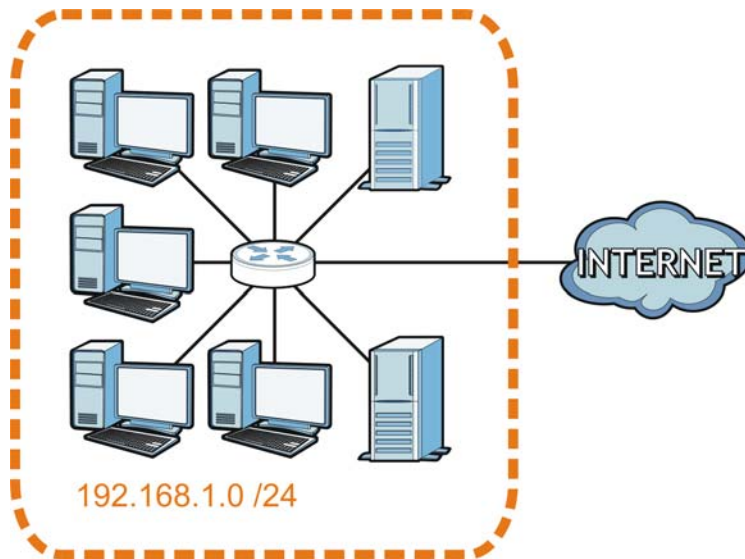
Figure 131 Subnetting Example: Before Subnetting

You can “borrow” one of the host ID bits to divide the network 192.168.1.0 into two separate sub-networks. The subnet mask is now 25 bits (255.255.255.128 or /25).

The “borrowed” host ID bit can have a value of either 0 or 1, allowing two subnets; 192.168.1.0 /25 and 192.168.1.128 /25.

The following figure shows the company network after subnetting. There are now two sub-networks, **A** and **B**.

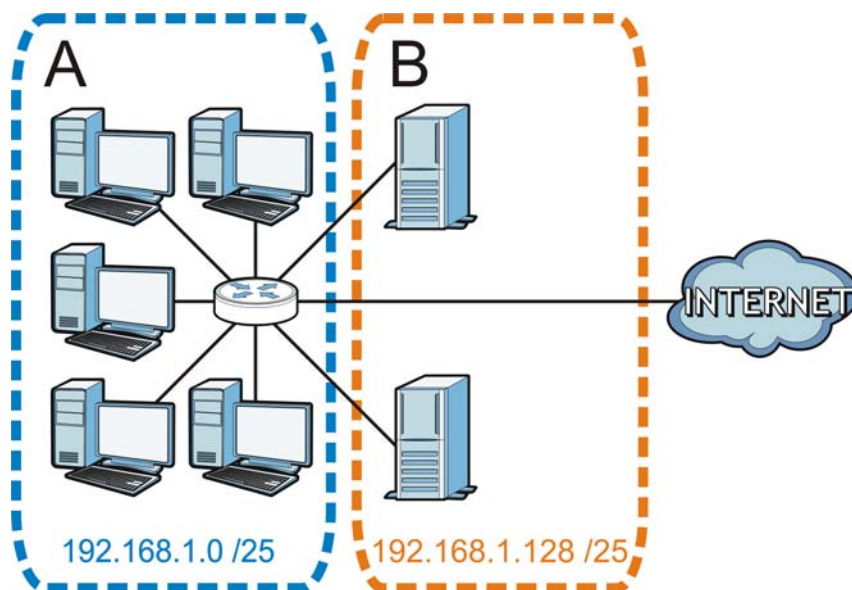
Figure 132 Subnetting Example: After Subnetting

In a 25-bit subnet the host ID has 7 bits, so each sub-network has a maximum of $2^7 - 2$ or 126 possible hosts (a host ID of all zeroes is the subnet's address itself, all ones is the subnet's broadcast address).

192.168.1.0 with mask 255.255.255.128 is subnet **A** itself, and 192.168.1.127 with mask 255.255.255.128 is its broadcast address. Therefore, the lowest IP address that can be assigned to an actual host for subnet **A** is 192.168.1.1 and the highest is 192.168.1.126.

Similarly, the host ID range for subnet **B** is 192.168.1.129 to 192.168.1.254.

Example: Four Subnets

The previous example illustrated using a 25-bit subnet mask to divide a 24-bit address into two subnets. Similarly, to divide a 24-bit address into four subnets, you need to "borrow" two host ID bits to give four possible combinations (00, 01, 10 and 11). The subnet mask is 26 bits (11111111.11111111.11111111.11000000) or 255.255.255.192.

Each subnet contains 6 host ID bits, giving $2^6 - 2$ or 62 hosts for each subnet (a host ID of all zeroes is the subnet itself, all ones is the subnet's broadcast address).

Table 85 Subnet 1

IP/SUBNET MASK	NETWORK NUMBER	LAST OCTET BIT VALUE
IP Address (Decimal)	192.168.1.	0
IP Address (Binary)	11000000.10101000.00000001.	00000000
Subnet Mask (Binary)	11111111.11111111.11111111.	11000000
Subnet Address: 192.168.1.0	Lowest Host ID: 192.168.1.1	
Broadcast Address: 192.168.1.63	Highest Host ID: 192.168.1.62	

Table 86 Subnet 2

IP/SUBNET MASK	NETWORK NUMBER	LAST OCTET BIT VALUE
IP Address	192.168.1.	64
IP Address (Binary)	11000000.10101000.00000001.	01000000
Subnet Mask (Binary)	11111111.11111111.11111111.	11000000
Subnet Address: 192.168.1.64	Lowest Host ID: 192.168.1.65	
Broadcast Address: 192.168.1.127	Highest Host ID: 192.168.1.126	

Table 87 Subnet 3

IP/SUBNET MASK	NETWORK NUMBER	LAST OCTET BIT VALUE
IP Address	192.168.1.	128
IP Address (Binary)	11000000.10101000.00000001.	10000000
Subnet Mask (Binary)	11111111.11111111.11111111.	11000000
Subnet Address: 192.168.1.128	Lowest Host ID: 192.168.1.129	
Broadcast Address: 192.168.1.191	Highest Host ID: 192.168.1.190	

Table 88 Subnet 4

IP/SUBNET MASK	NETWORK NUMBER	LAST OCTET BIT VALUE
IP Address	192.168.1.	192
IP Address (Binary)	11000000.10101000.00000001.	11000000
Subnet Mask (Binary)	11111111.11111111.11111111.	11000000
Subnet Address: 192.168.1.192	Lowest Host ID: 192.168.1.193	
Broadcast Address: 192.168.1.255	Highest Host ID: 192.168.1.254	

Example: Eight Subnets

Similarly, use a 27-bit mask to create eight subnets (000, 001, 010, 011, 100, 101, 110 and 111).

The following table shows IP address last octet values for each subnet.

Table 89 Eight Subnets

SUBNET	SUBNET ADDRESS	FIRST ADDRESS	LAST ADDRESS	BROADCAST ADDRESS
1	0	1	30	31
2	32	33	62	63
3	64	65	94	95
4	96	97	126	127
5	128	129	158	159
6	160	161	190	191

Table 89 Eight Subnets (continued)

SUBNET	SUBNET ADDRESS	FIRST ADDRESS	LAST ADDRESS	BROADCAST ADDRESS
7	192	193	222	223
8	224	225	254	255

Subnet Planning

The following table is a summary for subnet planning on a network with a 24-bit network number.

Table 90 24-bit Network Number Subnet Planning

NO. "BORROWED" HOST BITS	SUBNET MASK	NO. SUBNETS	NO. HOSTS PER SUBNET
1	255.255.255.128 (/25)	2	126
2	255.255.255.192 (/26)	4	62
3	255.255.255.224 (/27)	8	30
4	255.255.255.240 (/28)	16	14
5	255.255.255.248 (/29)	32	6
6	255.255.255.252 (/30)	64	2
7	255.255.255.254 (/31)	128	1

The following table is a summary for subnet planning on a network with a 16-bit network number.

Table 91 16-bit Network Number Subnet Planning

NO. "BORROWED" HOST BITS	SUBNET MASK	NO. SUBNETS	NO. HOSTS PER SUBNET
1	255.255.128.0 (/17)	2	32766
2	255.255.192.0 (/18)	4	16382
3	255.255.224.0 (/19)	8	8190
4	255.255.240.0 (/20)	16	4094
5	255.255.248.0 (/21)	32	2046
6	255.255.252.0 (/22)	64	1022
7	255.255.254.0 (/23)	128	510
8	255.255.255.0 (/24)	256	254
9	255.255.255.128 (/25)	512	126
10	255.255.255.192 (/26)	1024	62
11	255.255.255.224 (/27)	2048	30
12	255.255.255.240 (/28)	4096	14
13	255.255.255.248 (/29)	8192	6
14	255.255.255.252 (/30)	16384	2
15	255.255.255.254 (/31)	32768	1

Configuring IP Addresses

Where you obtain your network number depends on your particular situation. If the ISP or your network administrator assigns you a block of registered IP addresses, follow their instructions in selecting the IP addresses and the subnet mask.

If the ISP did not explicitly give you an IP network number, then most likely you have a single user account and the ISP will assign you a dynamic IP address when the connection is established. If this is the case, it is recommended that you select a network number from 192.168.0.0 to 192.168.255.0. The Internet Assigned Number Authority (IANA) reserved this block of addresses specifically for private use; please do not use any other number unless you are told otherwise. You must also enable Network Address Translation (NAT) on the NBG.

Once you have decided on the network number, pick an IP address for your NBG that is easy to remember (for instance, 192.168.1.1) but make sure that no other device on your network is using that IP address.

The subnet mask specifies the network number portion of an IP address. Your NBG will compute the subnet mask automatically based on the IP address that you entered. You don't need to change the subnet mask computed by the NBG unless you are instructed to do otherwise.

Private IP Addresses

Every machine on the Internet must have a unique address. If your networks are isolated from the Internet (running only between two branch offices, for example) you can assign any IP addresses to the hosts without problems. However, the Internet Assigned Numbers Authority (IANA) has reserved the following three blocks of IP addresses specifically for private networks:

- 10.0.0.0 — 10.255.255.255
- 172.16.0.0 — 172.31.255.255
- 192.168.0.0 — 192.168.255.255

You can obtain your IP address from the IANA, from an ISP, or it can be assigned from a private network. If you belong to a small organization and your Internet access is through an ISP, the ISP can provide you with the Internet addresses for your local networks. On the other hand, if you are part of a much larger organization, you should consult your network administrator for the appropriate IP addresses.

Regardless of your particular situation, do not create an arbitrary IP address; always follow the guidelines above. For more information on address assignment, please refer to RFC 1597, Address Allocation for Private Internets and RFC 1466, Guidelines for Management of IP Address Space.

IP Address Conflicts

Each device on a network must have a unique IP address. Devices with duplicate IP addresses on the same network will not be able to access the Internet or other resources. The devices may also be unreachable through the network.

Conflicting Computer IP Addresses Example

More than one device can not use the same IP address. In the following example computer **A** has a static (or fixed) IP address that is the same as the IP address that a DHCP server assigns to

computer **B** which is a DHCP client. Neither can access the Internet. This problem can be solved by assigning a different static IP address to computer **A** or setting computer **A** to obtain an IP address automatically.

Figure 133 Conflicting Computer IP Addresses Example

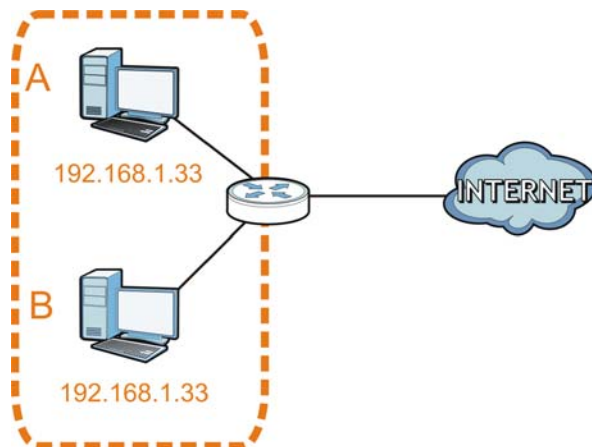

Conflicting Router IP Addresses Example

Since a router connects different networks, it must have interfaces using different network numbers. For example, if a router is set between a LAN and the Internet (WAN), the router's LAN and WAN addresses must be on different subnets. In the following example, the LAN and WAN are on the same subnet. The LAN computers cannot access the Internet because the router cannot route between networks.

Figure 134 Conflicting Router IP Addresses Example

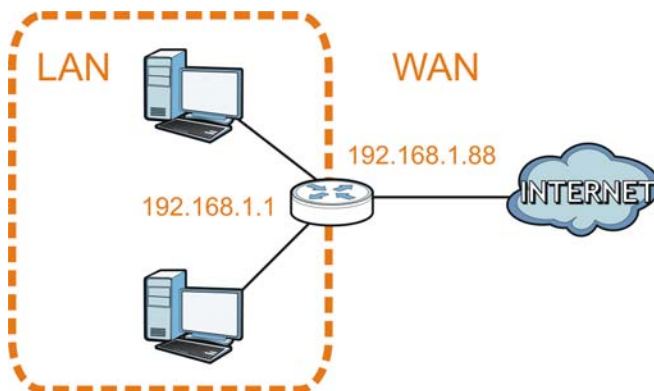

Conflicting Computer and Router IP Addresses Example

More than one device can not use the same IP address. In the following example, the computer and the router's LAN port both use 192.168.1.1 as the IP address. The computer cannot access the Internet. This problem can be solved by assigning a different IP address to the computer or the router's LAN port.

Figure 135 Conflicting Computer and Router IP Addresses Example

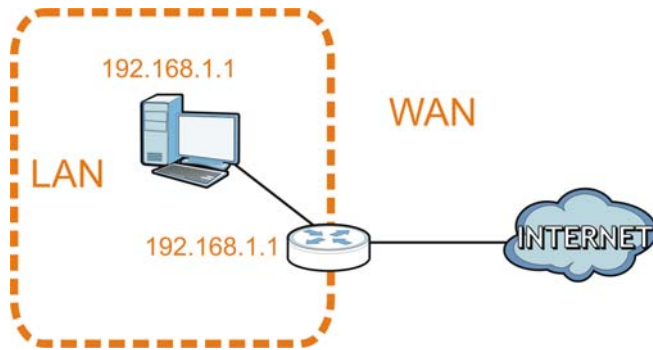

Setting Up Your Computer's IP Address

Note: Your specific NBG may not support all of the operating systems described in this appendix. See the product specifications for more information about which operating systems are supported.

This appendix shows you how to configure the IP settings on your computer in order for it to be able to communicate with the other devices on your network. Windows Vista/XP/2000, Mac OS 9/OS X, and all versions of UNIX/LINUX include the software components you need to use TCP/IP on your computer.

If you manually assign IP information instead of using a dynamic IP, make sure that your network's computers have IP addresses that place them in the same subnet.

In this appendix, you can set up an IP address for:

- [Windows XP/NT/2000](#) on [page 184](#)
- [Windows Vista](#) on [page 188](#)
- [Windows 7](#) on [page 192](#)
- [Mac OS X: 10.3 and 10.4](#) on [page 196](#)
- [Mac OS X: 10.5 and 10.6](#) on [page 199](#)
- [Linux: Ubuntu 8 \(GNOME\)](#) on [page 202](#)
- [Linux: openSUSE 10.3 \(KDE\)](#) on [page 206](#)

Windows XP/NT/2000

The following example uses the default Windows XP display theme but can also apply to Windows 2000 and Windows NT.

- 1 Click **Start > Control Panel**.

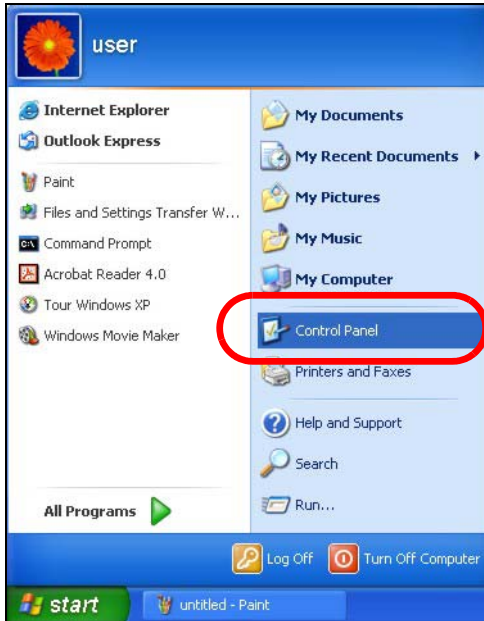

- 2 In the **Control Panel**, click the **Network Connections** icon.

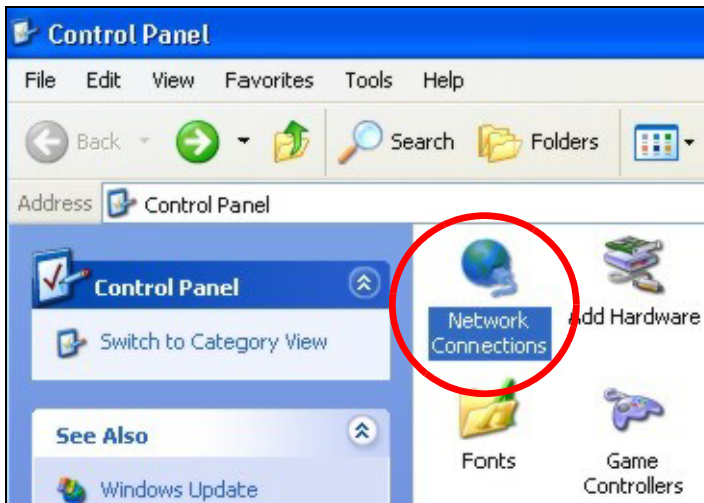

- 3 Right-click **Local Area Connection** and then select **Properties**.

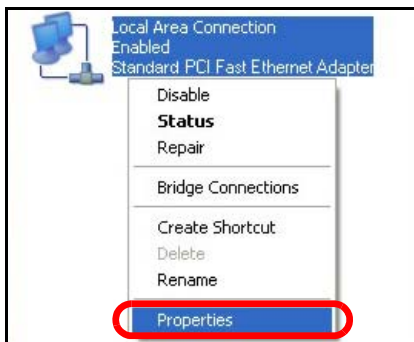

- 4 On the **General** tab, select **Internet Protocol (TCP/IP)** and then click **Properties**.

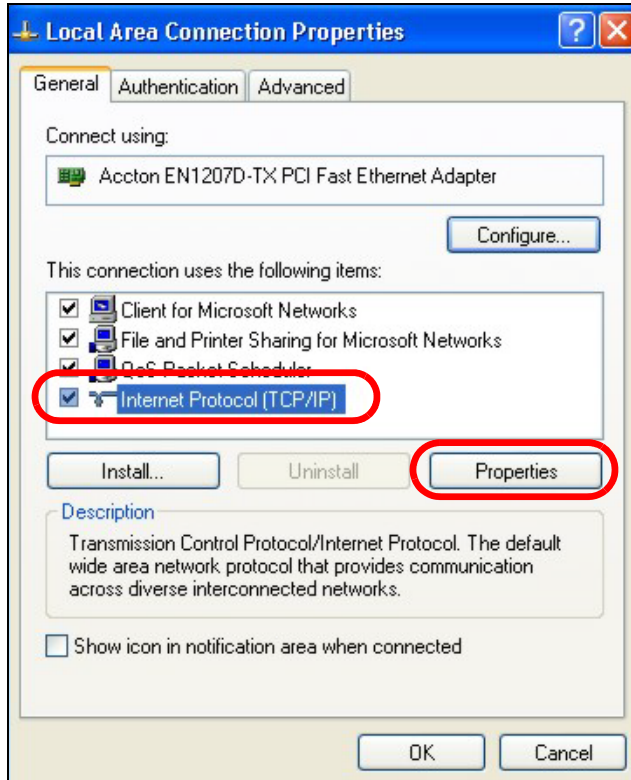

- 5 The **Internet Protocol TCP/IP Properties** window opens.

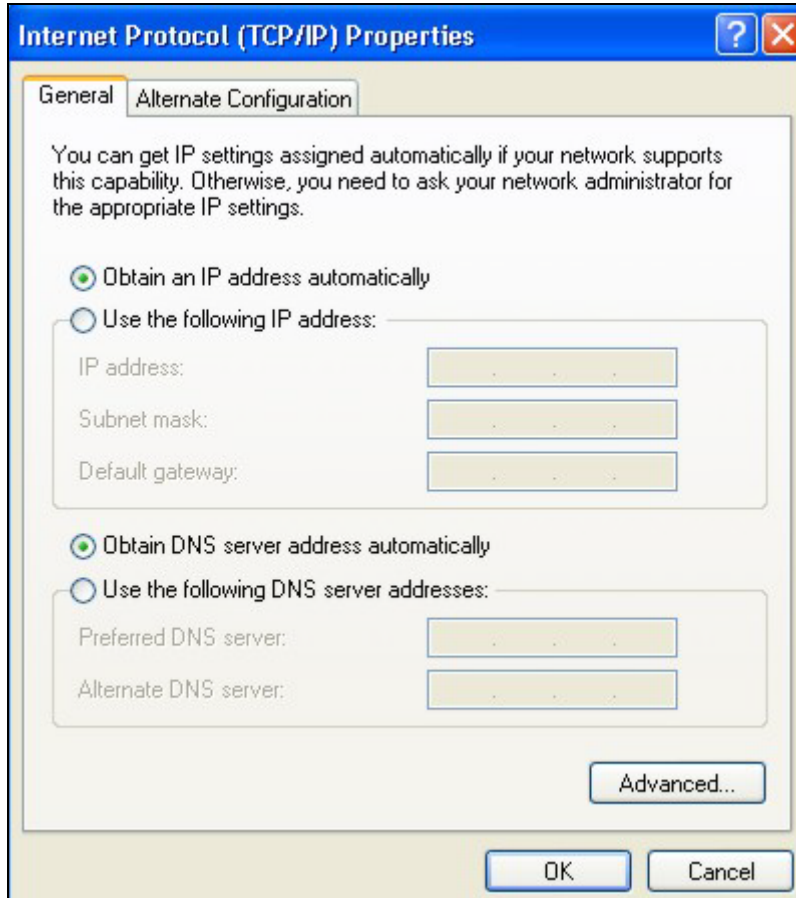

- 6 Select **Obtain an IP address automatically** if your network administrator or ISP assigns your IP address dynamically.

Select **Use the following IP Address** and fill in the **IP address**, **Subnet mask**, and **Default gateway** fields if you have a static IP address that was assigned to you by your network administrator or ISP. You may also have to enter a **Preferred DNS server** and an **Alternate DNS server**, if that information was provided.

- 7 Click **OK** to close the **Internet Protocol (TCP/IP) Properties** window.
- 8 Click **OK** to close the **Local Area Connection Properties** window.

Verifying Settings

- 1 Click **Start > All Programs > Accessories > Command Prompt**.
- 2 In the **Command Prompt** window, type "ipconfig" and then press [ENTER].

You can also go to **Start > Control Panel > Network Connections**, right-click a network connection, click **Status** and then click the **Support** tab to view your IP address and connection information.

Windows Vista

This section shows screens from Windows Vista Professional.

- 1 Click **Start > Control Panel**.

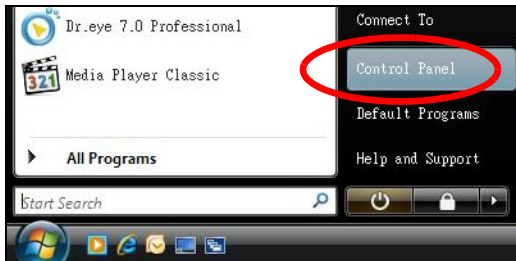

- 2 In the **Control Panel**, click the **Network and Internet** icon.

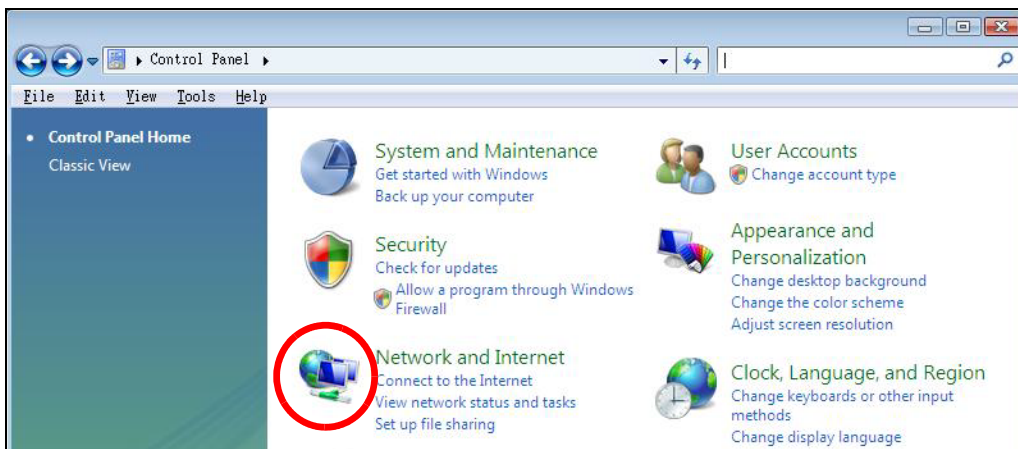

- 3 Click the **Network and Sharing Center** icon.

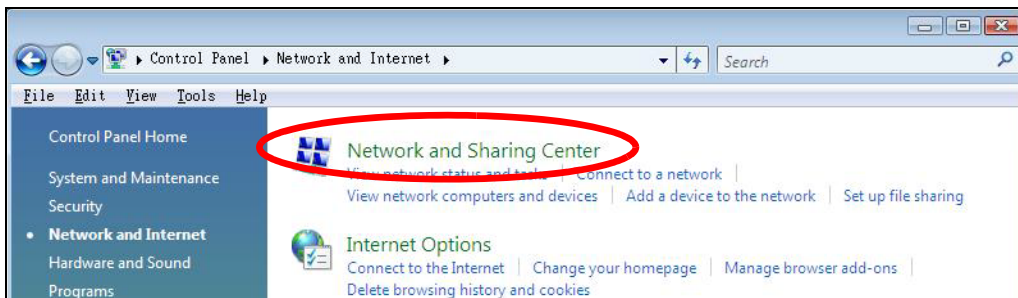

- 4 Click **Manage network connections**.

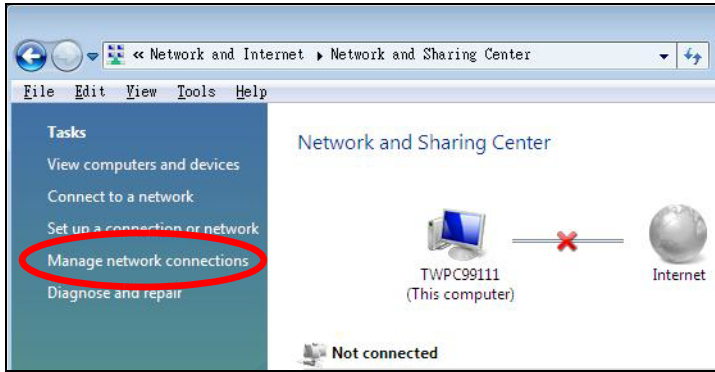

- 5 Right-click **Local Area Connection** and then select **Properties**.

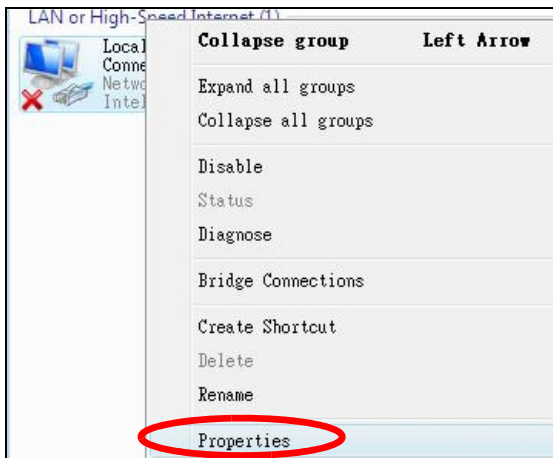

Note: During this procedure, click **Continue** whenever Windows displays a screen saying that it needs your permission to continue.

- 6 Select **Internet Protocol Version 4 (TCP/IPv4)** and then select **Properties**.

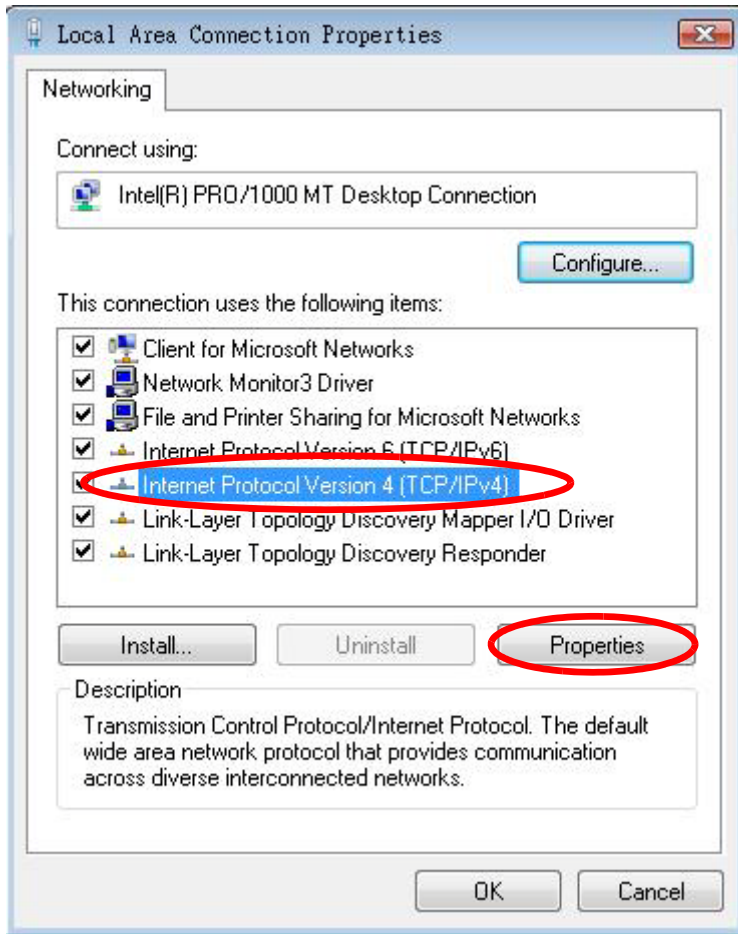

- 7 The **Internet Protocol Version 4 (TCP/IPv4) Properties** window opens.

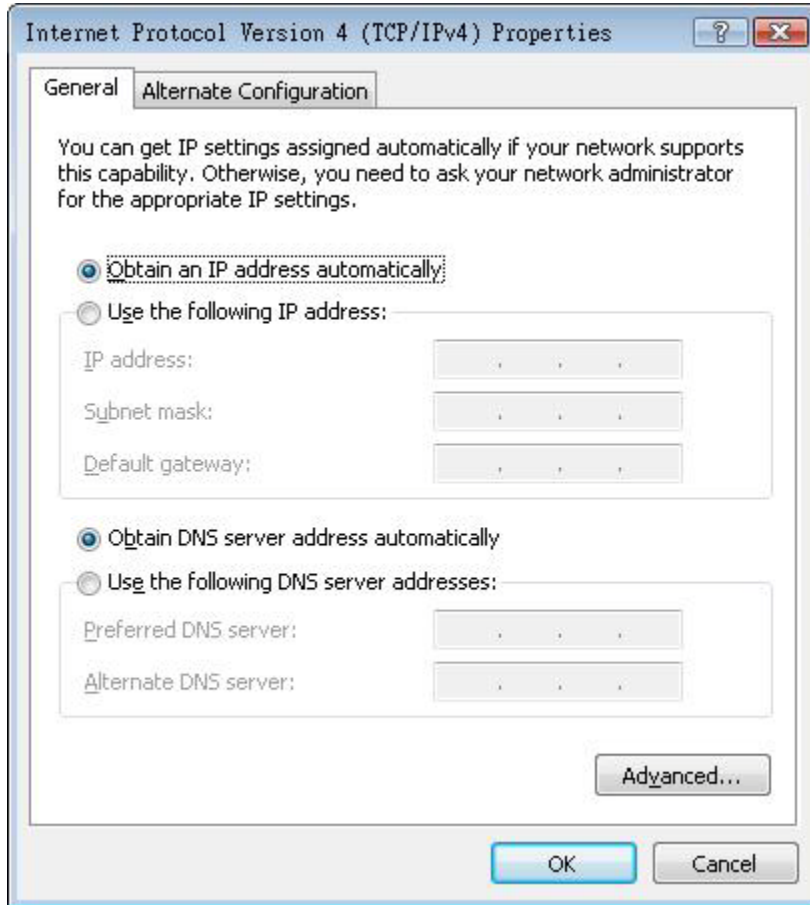

- 8 Select **Obtain an IP address automatically** if your network administrator or ISP assigns your IP address dynamically.

Select **Use the following IP Address** and fill in the **IP address**, **Subnet mask**, and **Default gateway** fields if you have a static IP address that was assigned to you by your network administrator or ISP. You may also have to enter a **Preferred DNS server** and an **Alternate DNS server**, if that information was provided. Click **Advanced**.

- 9 Click **OK** to close the **Internet Protocol (TCP/IP) Properties** window.
- 10 Click **OK** to close the **Local Area Connection Properties** window.

Verifying Settings

- 1 Click **Start > All Programs > Accessories > Command Prompt**.
- 2 In the **Command Prompt** window, type "ipconfig" and then press [ENTER].
You can also go to **Start > Control Panel > Network Connections**, right-click a network connection, click **Status** and then click the **Support** tab to view your IP address and connection information.

Windows 7

This section shows screens from Windows 7 Enterprise.

- 1 Click **Start > Control Panel**.

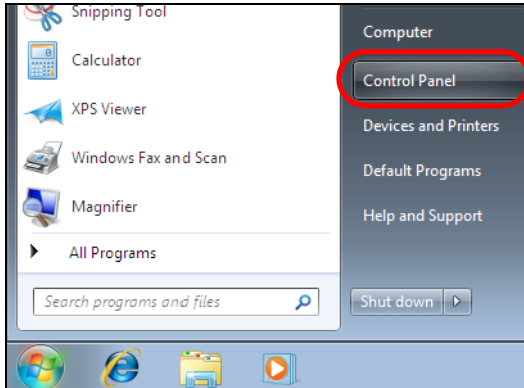

- 2 In the **Control Panel**, click **View network status and tasks** under the **Network and Internet** category.

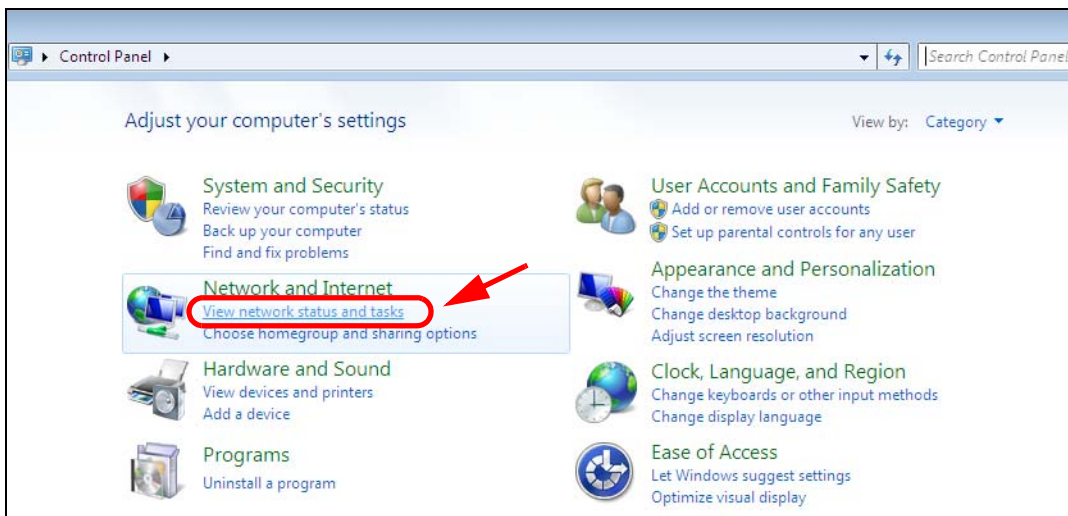

- 3 Click **Change adapter settings**.

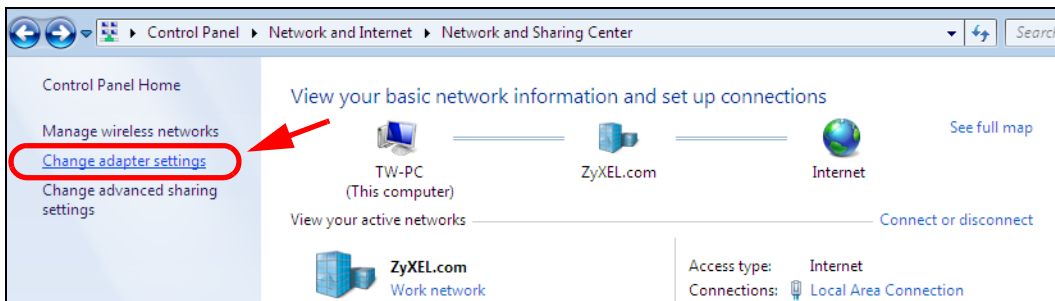

- 4 Double click **Local Area Connection** and then select **Properties**.

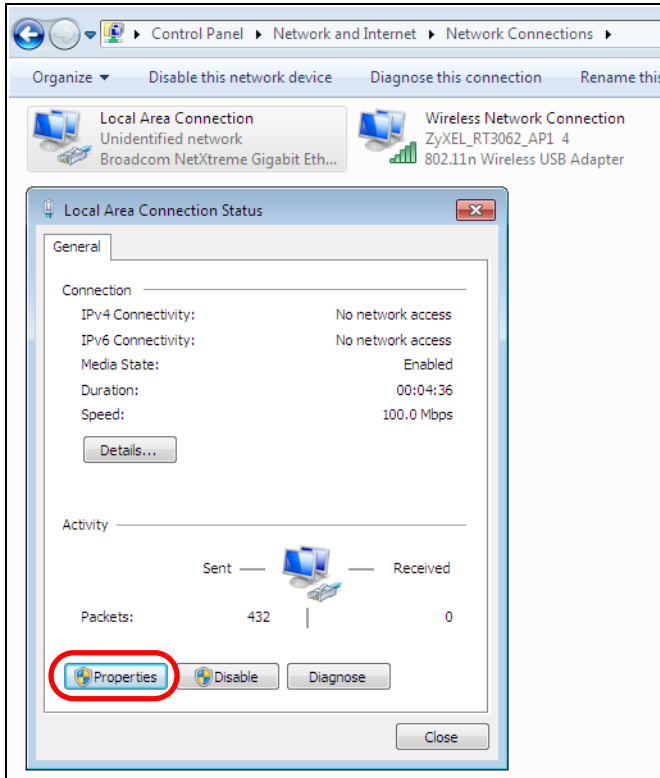

Note: During this procedure, click **Continue** whenever Windows displays a screen saying that it needs your permission to continue.

- 5 Select **Internet Protocol Version 4 (TCP/IPv4)** and then select **Properties**.

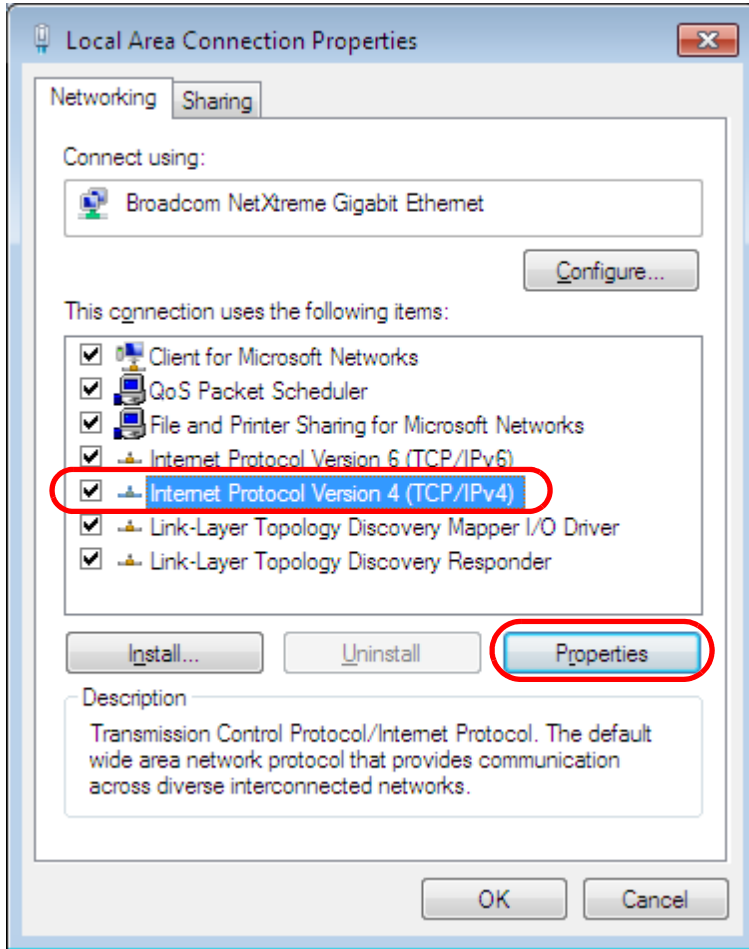

- 6 The **Internet Protocol Version 4 (TCP/IPv4) Properties** window opens.

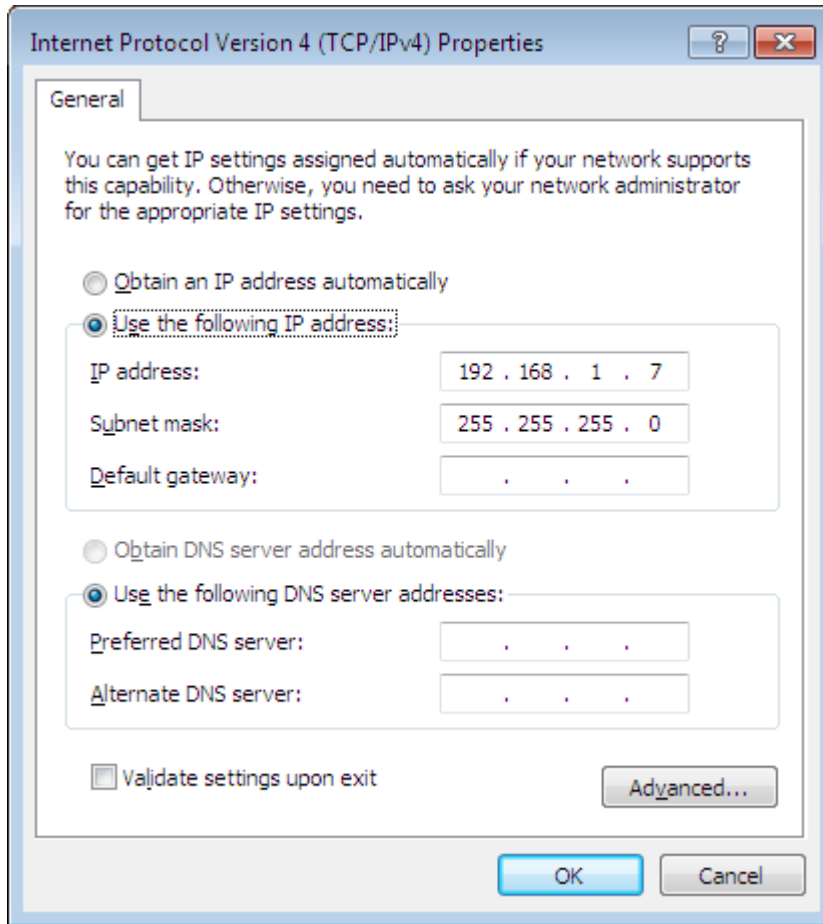

- 7 Select **Obtain an IP address automatically** if your network administrator or ISP assigns your IP address dynamically.

Select **Use the following IP Address** and fill in the **IP address**, **Subnet mask**, and **Default gateway** fields if you have a static IP address that was assigned to you by your network administrator or ISP. You may also have to enter a **Preferred DNS server** and an **Alternate DNS server**, if that information was provided. Click **Advanced** if you want to configure advanced settings for IP, DNS and WINS.

- 8 Click **OK** to close the **Internet Protocol (TCP/IP) Properties** window.
- 9 Click **OK** to close the **Local Area Connection Properties** window.

Verifying Settings

- 1 Click **Start > All Programs > Accessories > Command Prompt**.
- 2 In the **Command Prompt** window, type "ipconfig" and then press [ENTER].
- 3 The IP settings are displayed as follows.

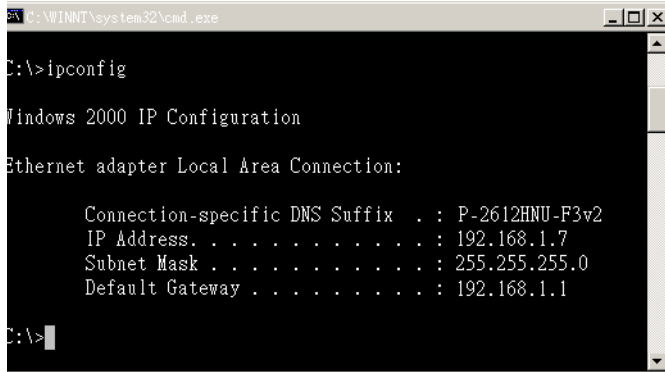

```
C:\WINNT\system32\cmd.exe
C:\>ipconfig

Windows 2000 IP Configuration

Ethernet adapter Local Area Connection:

    Connection-specific DNS Suffix  . : P-2612HNU-F3v2
    IP Address. . . . . : 192.168.1.7
    Subnet Mask . . . . . : 255.255.255.0
    Default Gateway . . . . . : 192.168.1.1

C:\>
```

Mac OS X: 10.3 and 10.4

The screens in this section are from Mac OS X 10.4 but can also apply to 10.3.

- 1 Click **Apple** > **System Preferences**.



- 2 In the **System Preferences** window, click the **Network** icon.



- 3 When the **Network** preferences pane opens, select **Built-in Ethernet** from the network connection type list, and then click **Configure**.

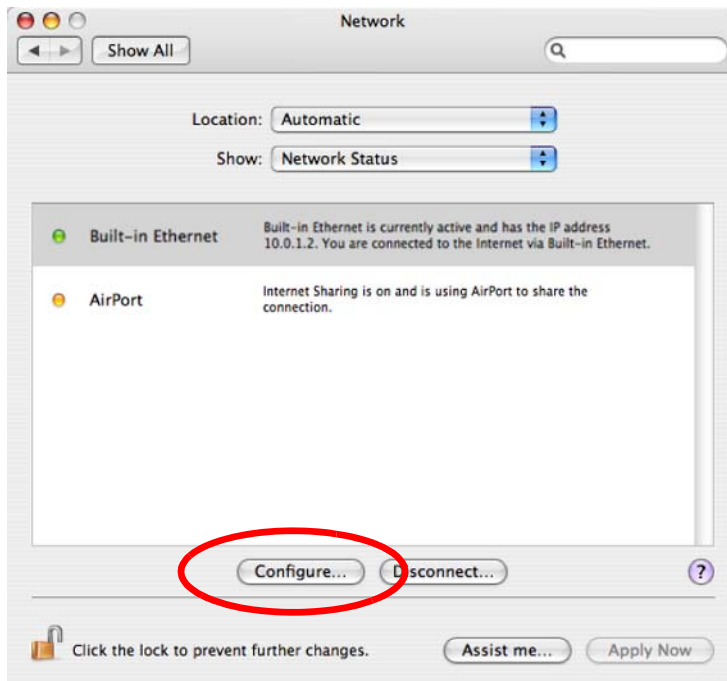

- 4 For dynamically assigned settings, select **Using DHCP** from the **Configure IPv4** list in the **TCP/IP** tab.

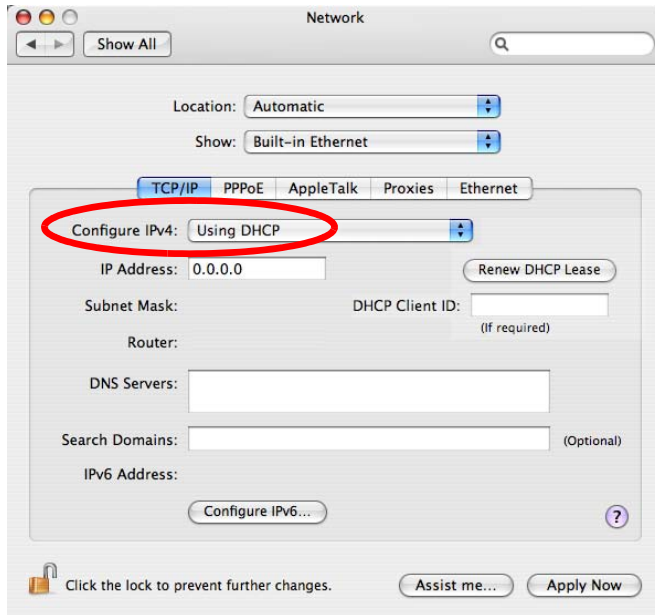

- 5 For statically assigned settings, do the following:
 - From the **Configure IPv4** list, select **Manually**.
 - In the **IP Address** field, type your IP address.
 - In the **Subnet Mask** field, type your subnet mask.
 - In the **Router** field, type the IP address of your device.

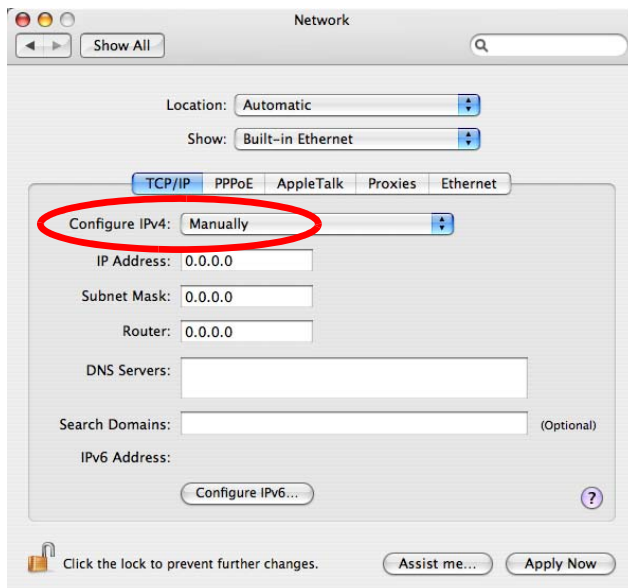

- 6 Click **Apply Now** and close the window.

Verifying Settings

Check your TCP/IP properties by clicking **Applications > Utilities > Network Utilities**, and then selecting the appropriate **Network Interface** from the **Info** tab.

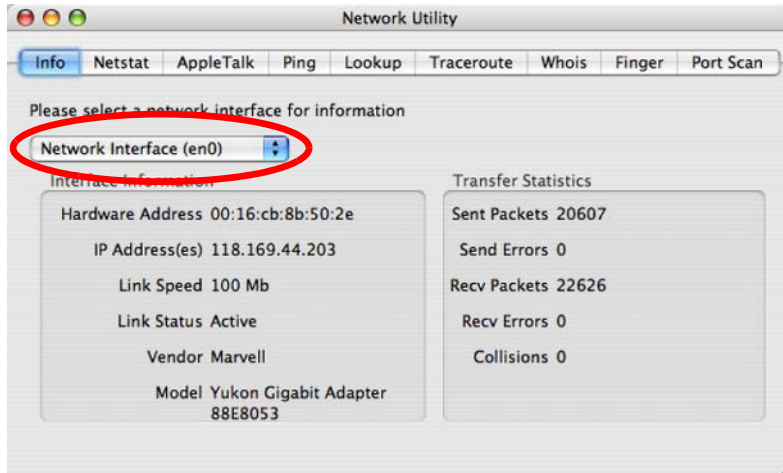
Figure 136 Mac OS X 10.4: Network Utility

Mac OS X: 10.5 and 10.6

The screens in this section are from Mac OS X 10.5 but can also apply to 10.6.

- 1 Click **Apple > System Preferences**.

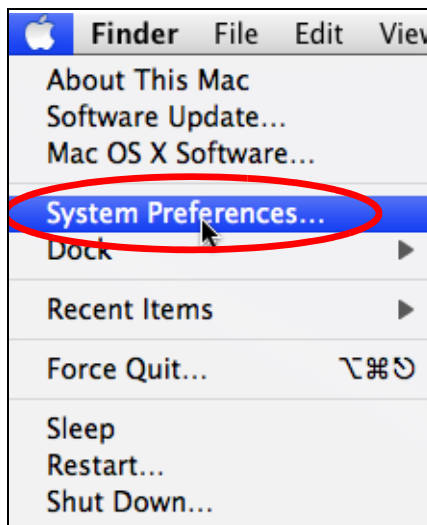

- 2 In **System Preferences**, click the **Network** icon.



- 3 When the **Network** preferences pane opens, select **Ethernet** from the list of available connection types.

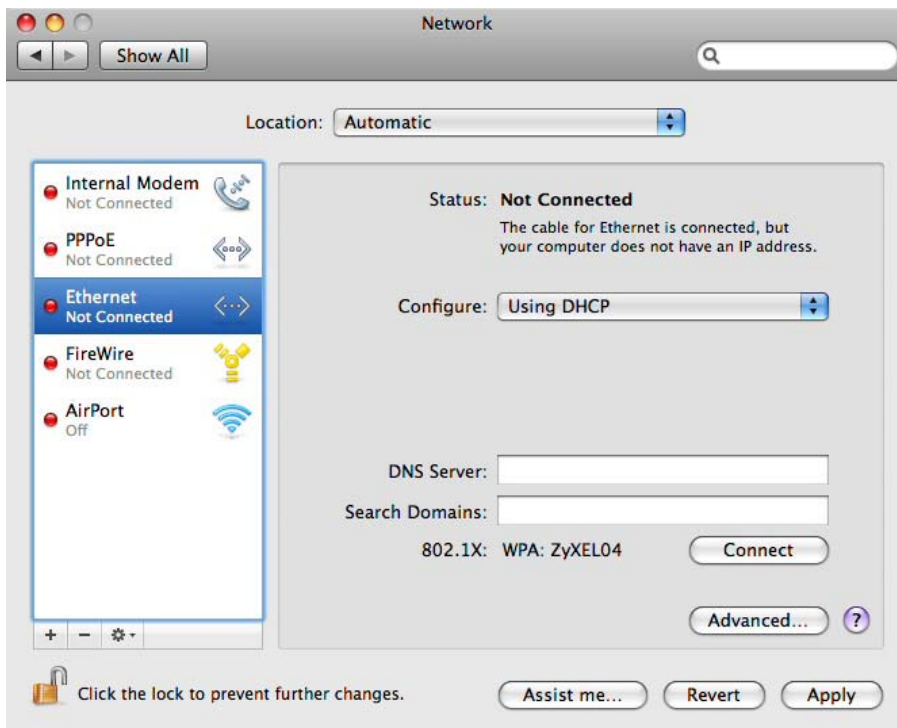

- 4 From the **Configure** list, select **Using DHCP** for dynamically assigned settings.

- 5 For statically assigned settings, do the following:
 - From the **Configure** list, select **Manually**.
 - In the **IP Address** field, enter your IP address.
 - In the **Subnet Mask** field, enter your subnet mask.
 - In the **Router** field, enter the IP address of your NBG.

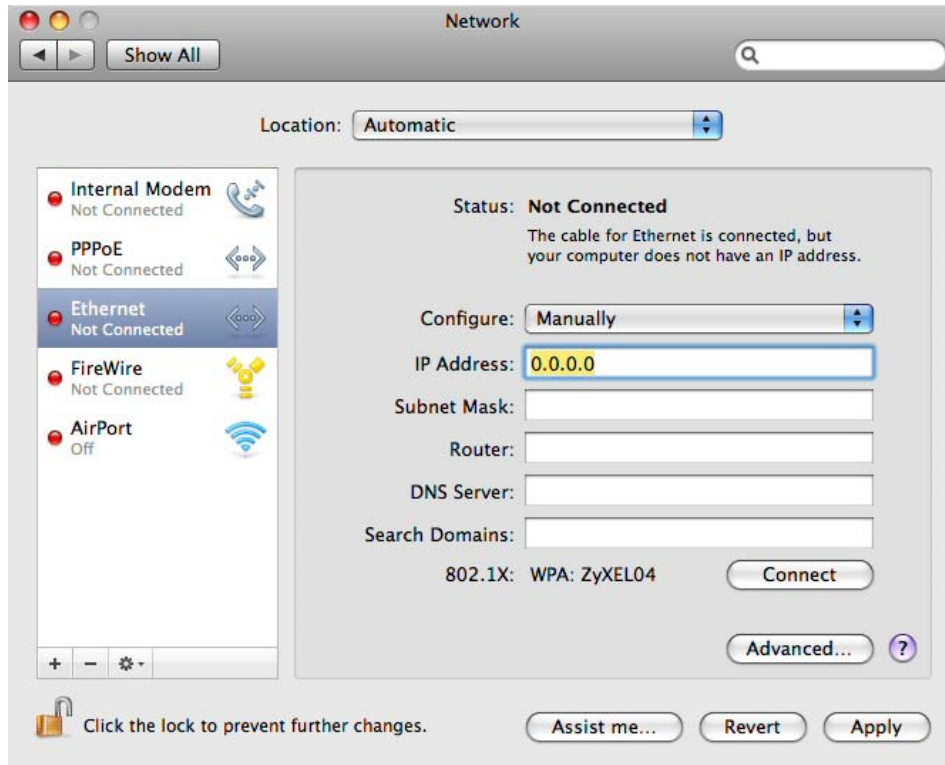

- 6 Click **Apply** and close the window.

Verifying Settings

Check your TCP/IP properties by clicking **Applications > Utilities > Network Utilities**, and then selecting the appropriate **Network interface** from the **Info** tab.

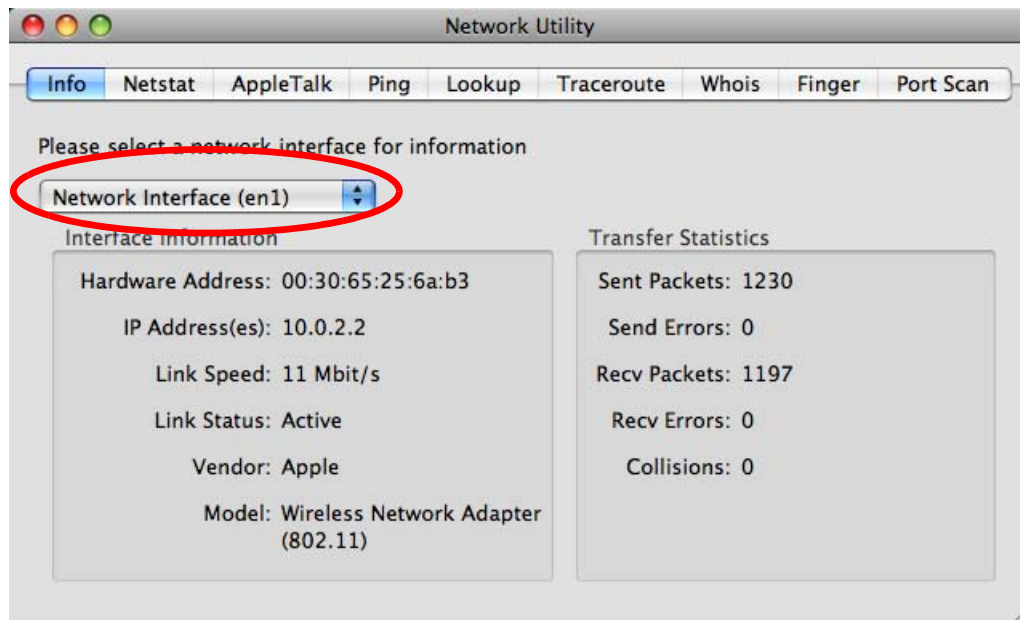
Figure 137 Mac OS X 10.5: Network Utility

Linux: Ubuntu 8 (GNOME)

This section shows you how to configure your computer's TCP/IP settings in the GNU Object Model Environment (GNOME) using the Ubuntu 8 Linux distribution. The procedure, screens and file locations may vary depending on your specific distribution, release version, and individual configuration. The following screens use the default Ubuntu 8 installation.

Note: Make sure you are logged in as the root administrator.

Follow the steps below to configure your computer IP address in GNOME:

- 1 Click **System > Administration > Network**.

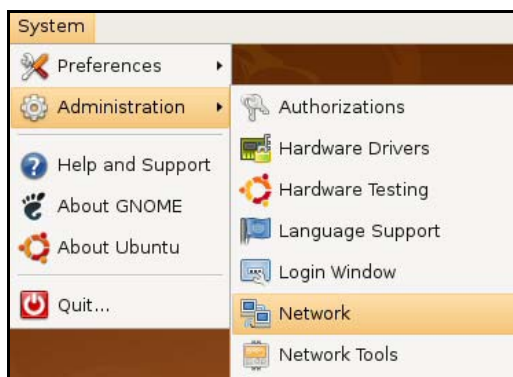

- 2 When the **Network Settings** window opens, click **Unlock** to open the **Authenticate** window. (By default, the **Unlock** button is greyed out until clicked.) You cannot make changes to your configuration unless you first enter your admin password.

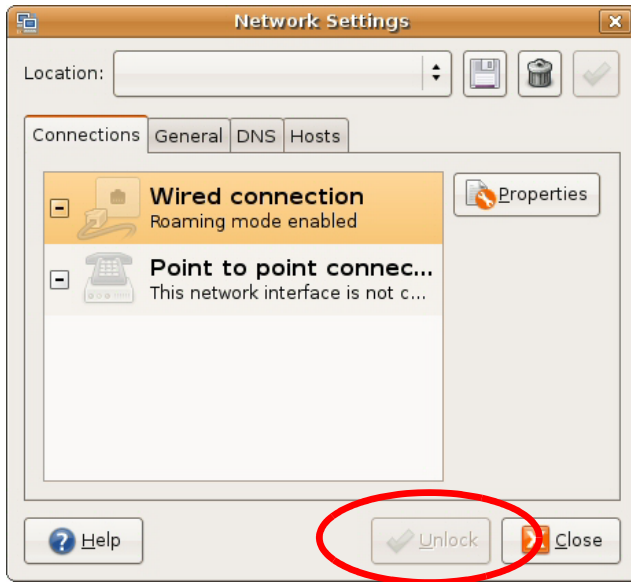

- 3 In the **Authenticate** window, enter your admin account name and password then click the **Authenticate** button.



- 4 In the **Network Settings** window, select the connection that you want to configure, then click **Properties**.

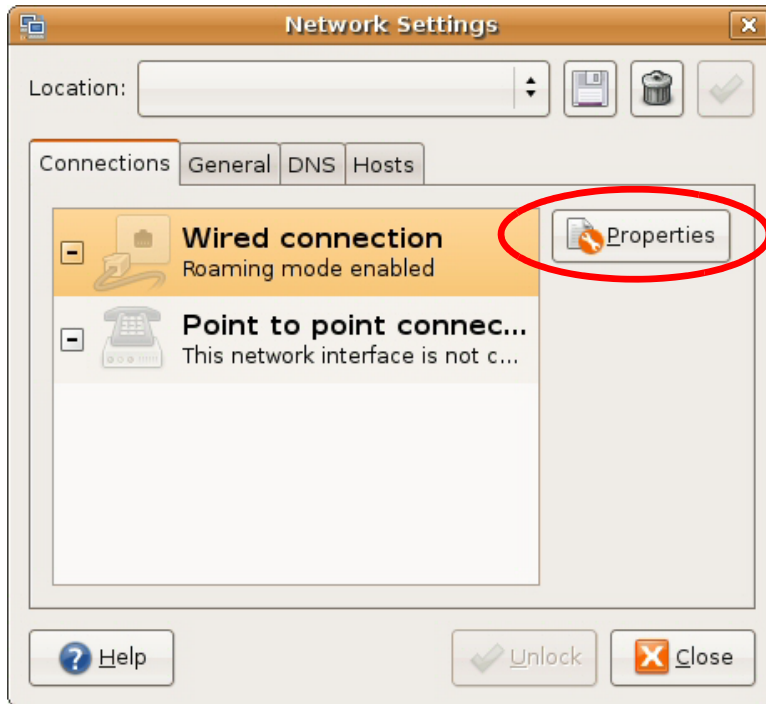

- 5 The **Properties** dialog box opens.

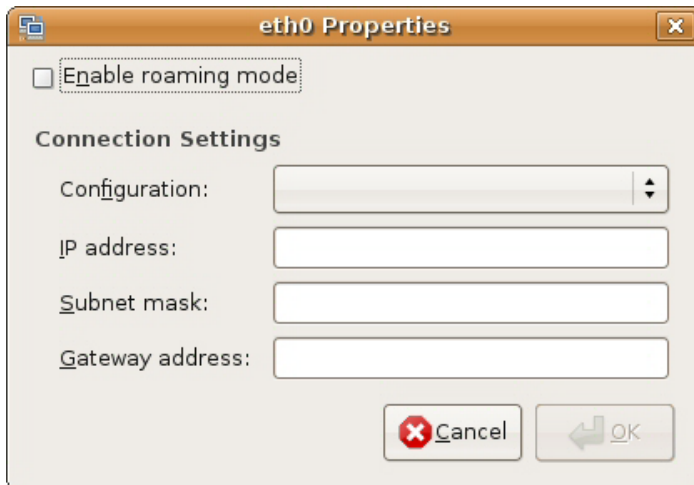

- In the **Configuration** list, select **Automatic Configuration (DHCP)** if you have a dynamic IP address.
 - In the **Configuration** list, select **Static IP address** if you have a static IP address. Fill in the **IP address**, **Subnet mask**, and **Gateway address** fields.
- 6 Click **OK** to save the changes and close the **Properties** dialog box and return to the **Network Settings** screen.
- 7 If you know your DNS server IP address(es), click the **DNS** tab in the **Network Settings** window and then enter the DNS server information in the fields provided.

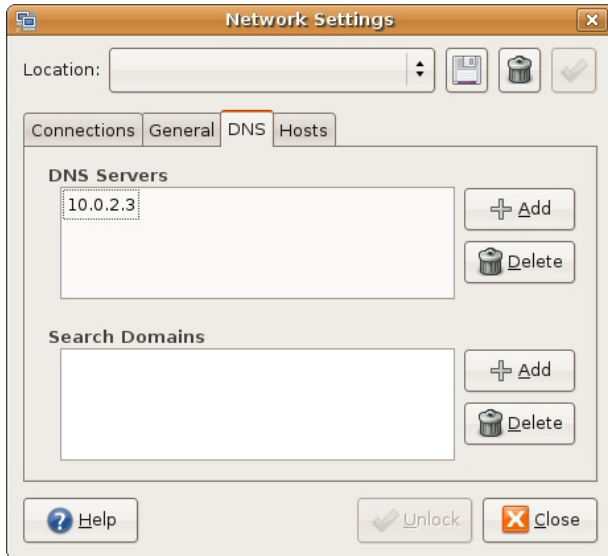

- 8 Click the **Close** button to apply the changes.

Verifying Settings

Check your TCP/IP properties by clicking **System > Administration > Network Tools**, and then selecting the appropriate **Network device** from the **Devices** tab. The **Interface Statistics** column shows data if your connection is working properly.

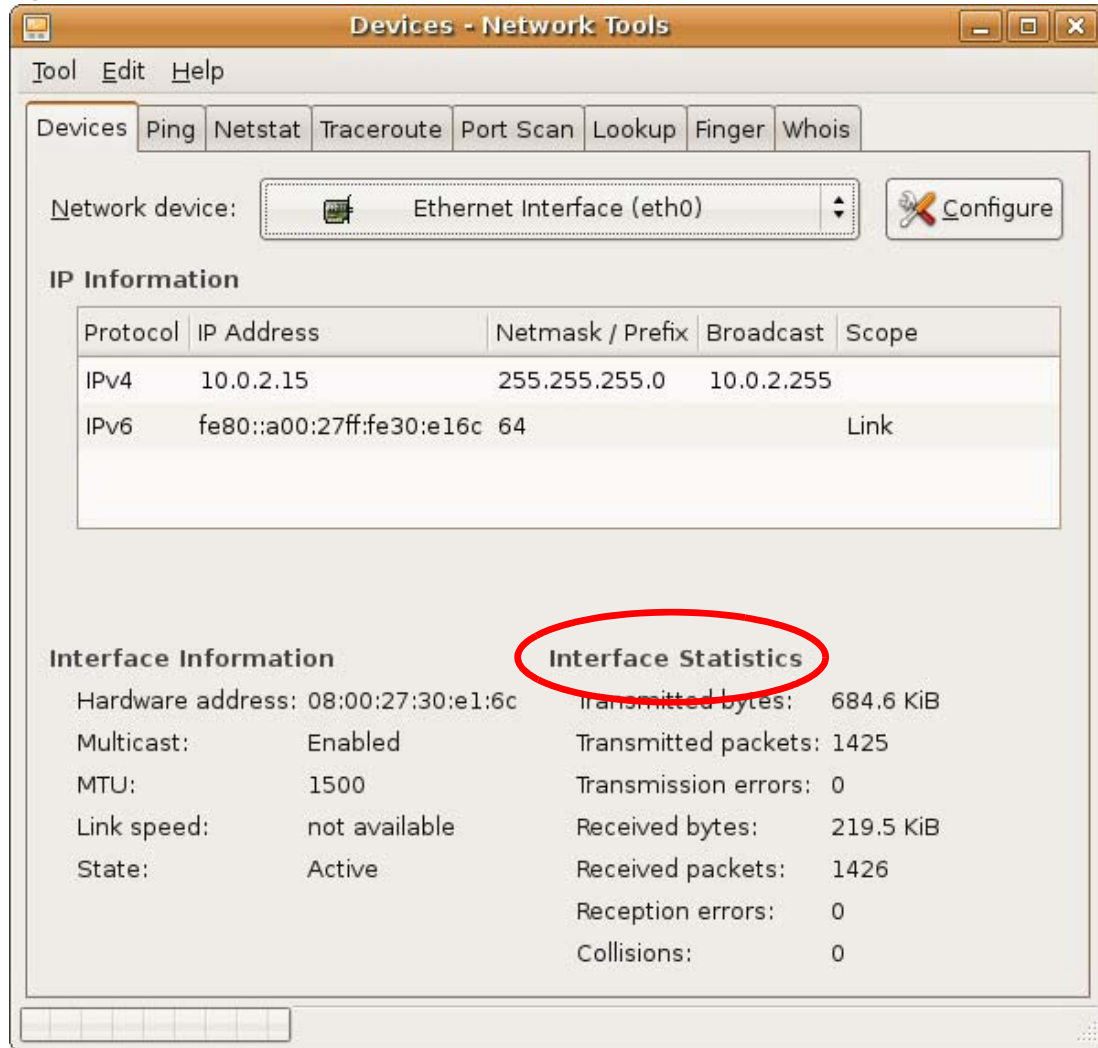
Figure 138 Ubuntu 8: Network Tools

Linux: openSUSE 10.3 (KDE)

This section shows you how to configure your computer's TCP/IP settings in the K Desktop Environment (KDE) using the openSUSE 10.3 Linux distribution. The procedure, screens and file locations may vary depending on your specific distribution, release version, and individual configuration. The following screens use the default openSUSE 10.3 installation.

Note: Make sure you are logged in as the root administrator.

Follow the steps below to configure your computer IP address in the KDE:

- 1 Click **K Menu > Computer > Administrator Settings (YaST)**.

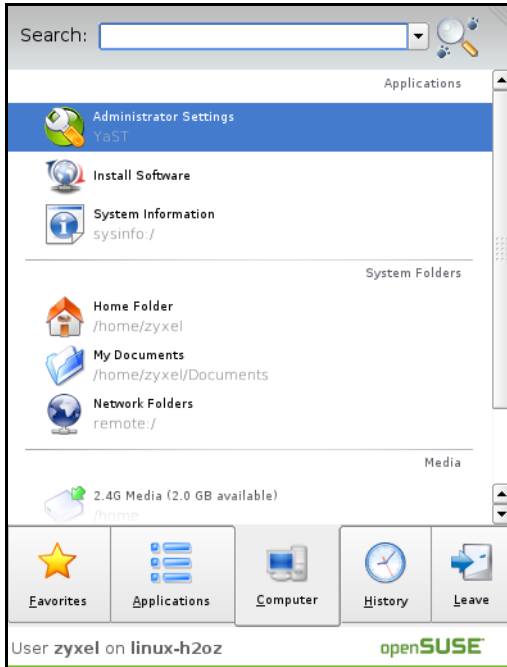

- 2 When the **Run as Root - KDE su** dialog opens, enter the admin password and click **OK**.



- 3 When the **YaST Control Center** window opens, select **Network Devices** and then click the **Network Card** icon.

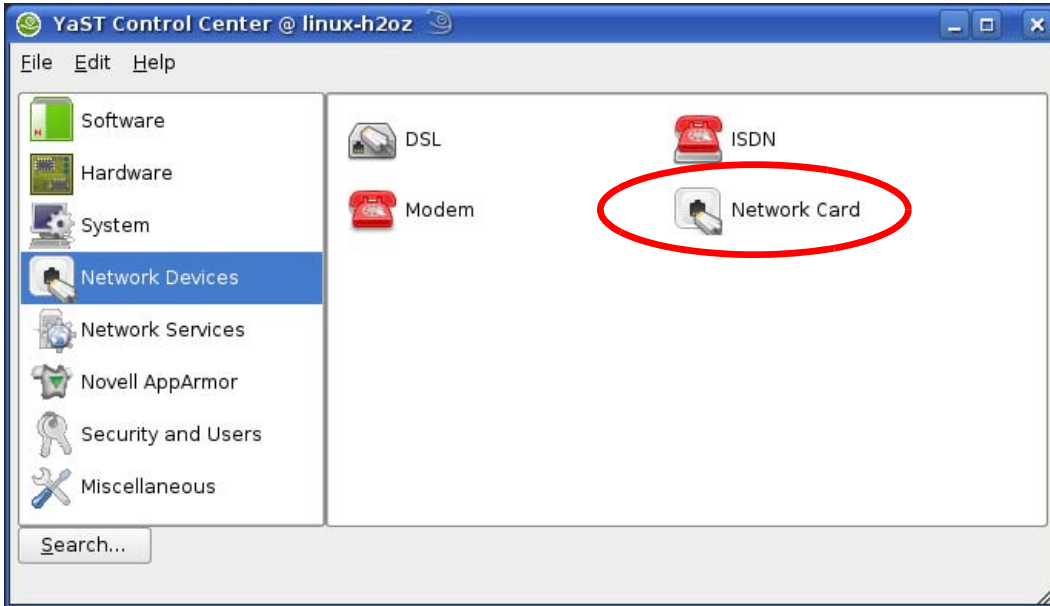

- 4 When the **Network Settings** window opens, click the **Overview** tab, select the appropriate connection **Name** from the list, and then click the **Configure** button.

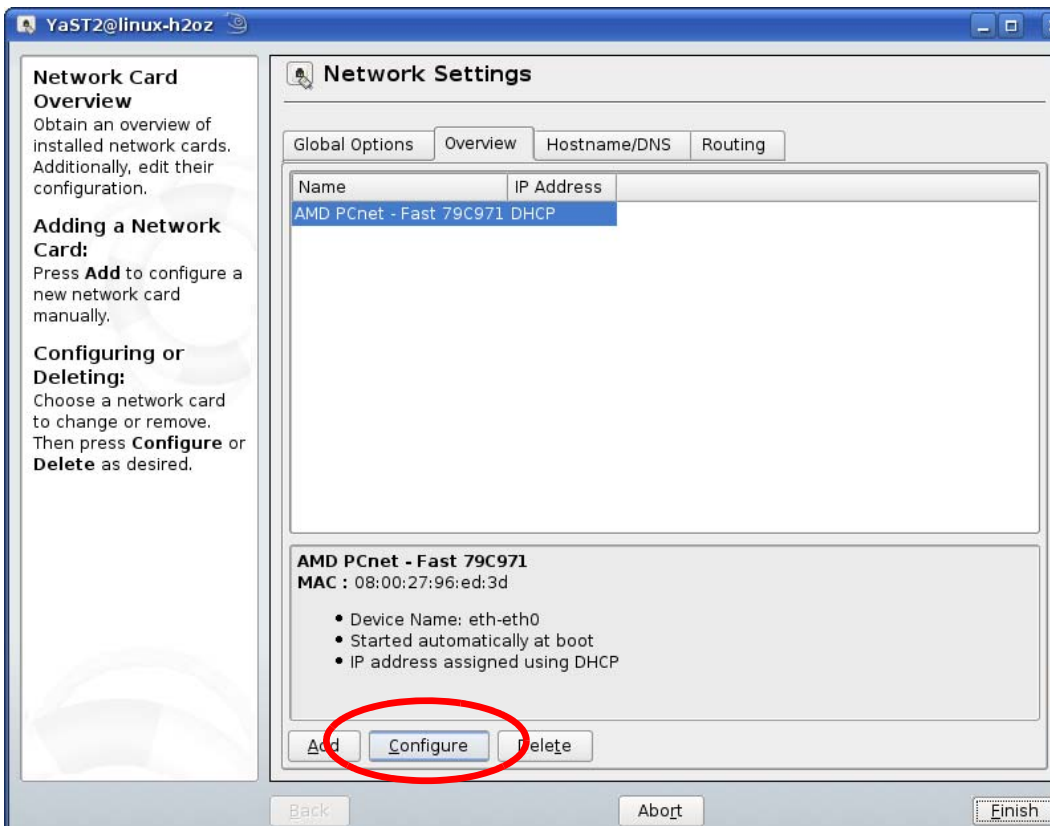

- 5 When the **Network Card Setup** window opens, click the **Address** tab

Figure 139 openSUSE 10.3: Network Card Setup

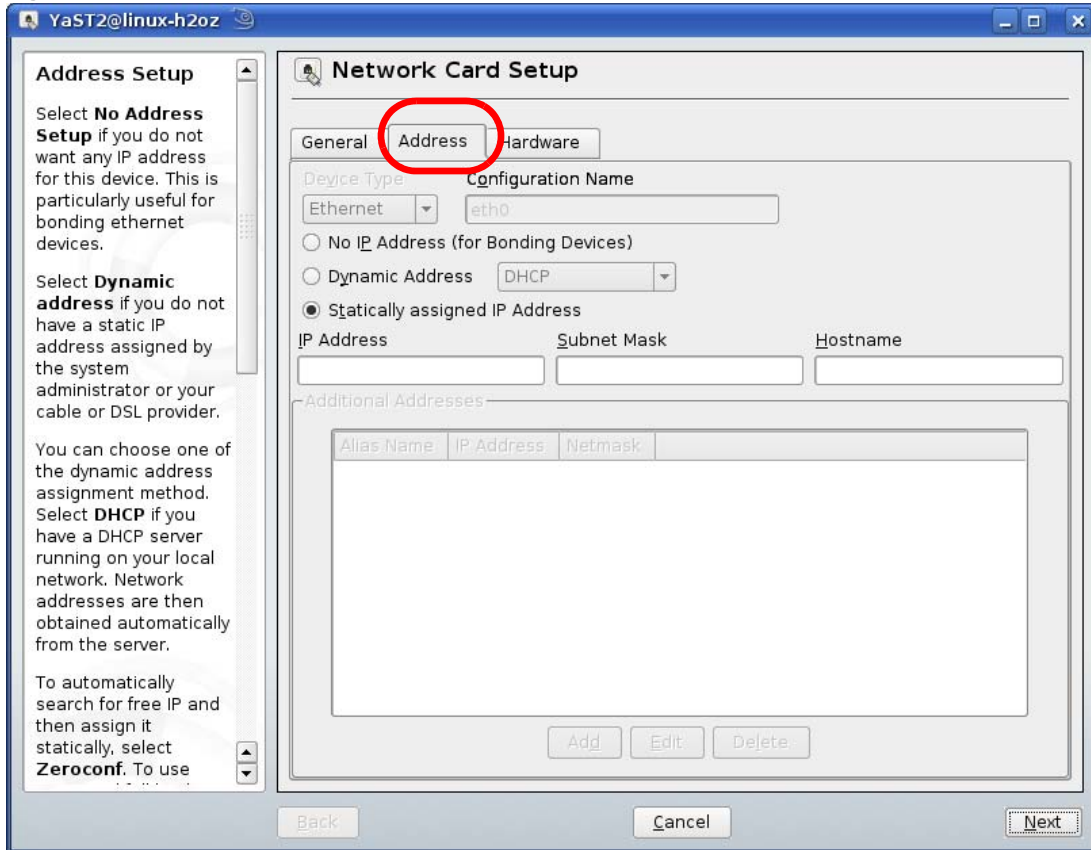

- 6 Select **Dynamic Address (DHCP)** if you have a dynamic IP address. Select **Statically assigned IP Address** if you have a static IP address. Fill in the **IP address**, **Subnet mask**, and **Hostname** fields.
- 7 Click **Next** to save the changes and close the **Network Card Setup** window.
- 8 If you know your DNS server IP address(es), click the **Hostname/DNS** tab in **Network Settings** and then enter the DNS server information in the fields provided.

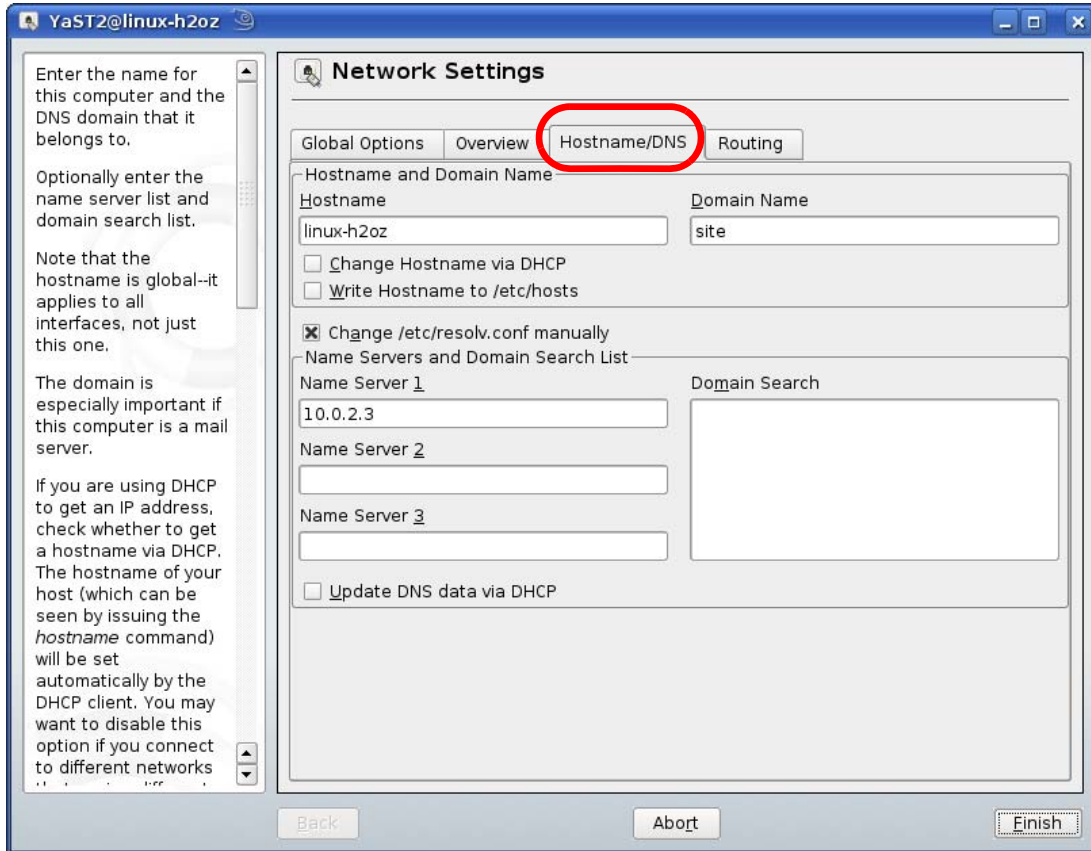

- 9 Click **Finish** to save your settings and close the window.

Verifying Settings

Click the **KNetwork Manager** icon on the **Task bar** to check your TCP/IP properties. From the **Options** sub-menu, select **Show Connection Information**.

Figure 140 openSUSE 10.3: KNetwork Manager

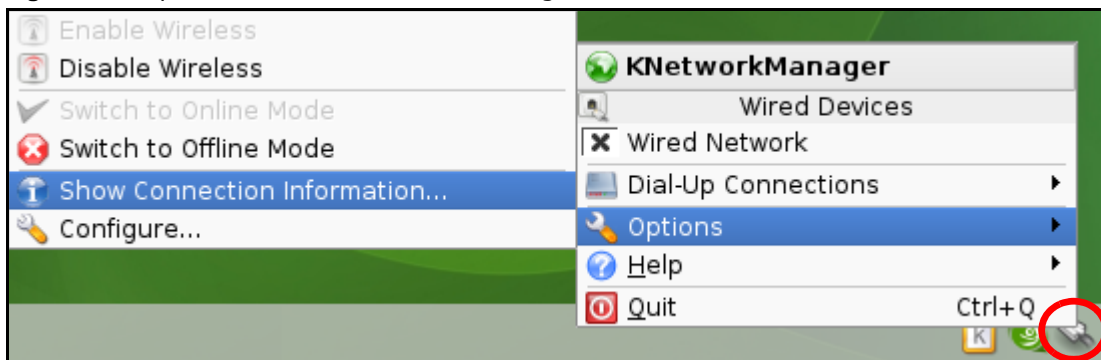

When the **Connection Status - KNetwork Manager** window opens, click the **Statistics** tab to see if your connection is working properly.

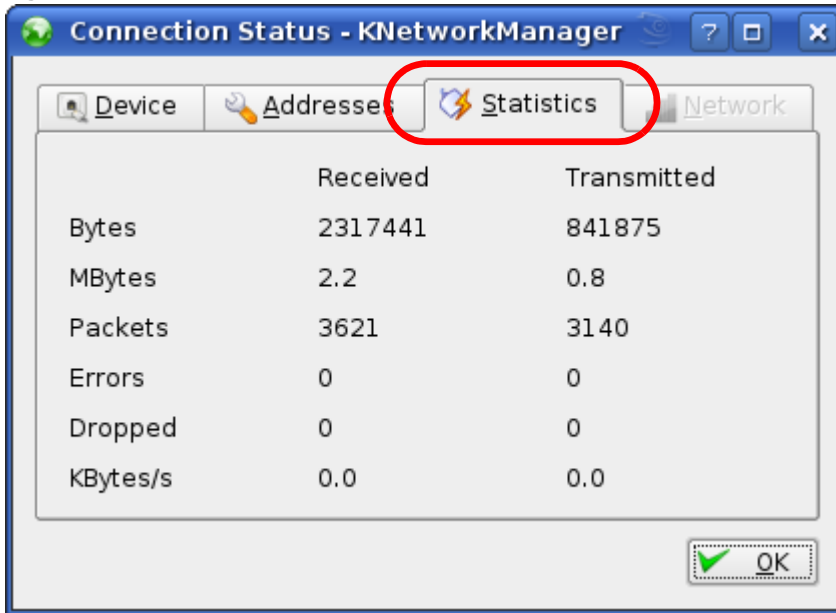
Figure 141 openSUSE: Connection Status - KNetwork Manager

Wireless LANs

Wireless LAN Topologies

This section discusses ad-hoc and infrastructure wireless LAN topologies.

Ad-hoc Wireless LAN Configuration

The simplest WLAN configuration is an independent (Ad-hoc) WLAN that connects a set of computers with wireless adapters (A, B, C). Any time two or more wireless adapters are within range of each other, they can set up an independent network, which is commonly referred to as an ad-hoc network or Independent Basic Service Set (IBSS). The following diagram shows an example of notebook computers using wireless adapters to form an ad-hoc wireless LAN.

Figure 142 Peer-to-Peer Communication in an Ad-hoc Network

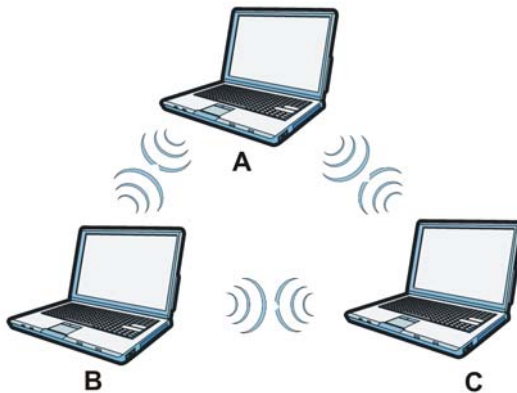

BSS

A Basic Service Set (BSS) exists when all communications between wireless clients or between a wireless client and a wired network client go through one access point (AP).

Intra-BSS traffic is traffic between wireless clients in the BSS. When Intra-BSS is enabled, wireless client **A** and **B** can access the wired network and communicate with each other. When Intra-BSS is disabled, wireless client **A** and **B** can still access the wired network but cannot communicate with each other.

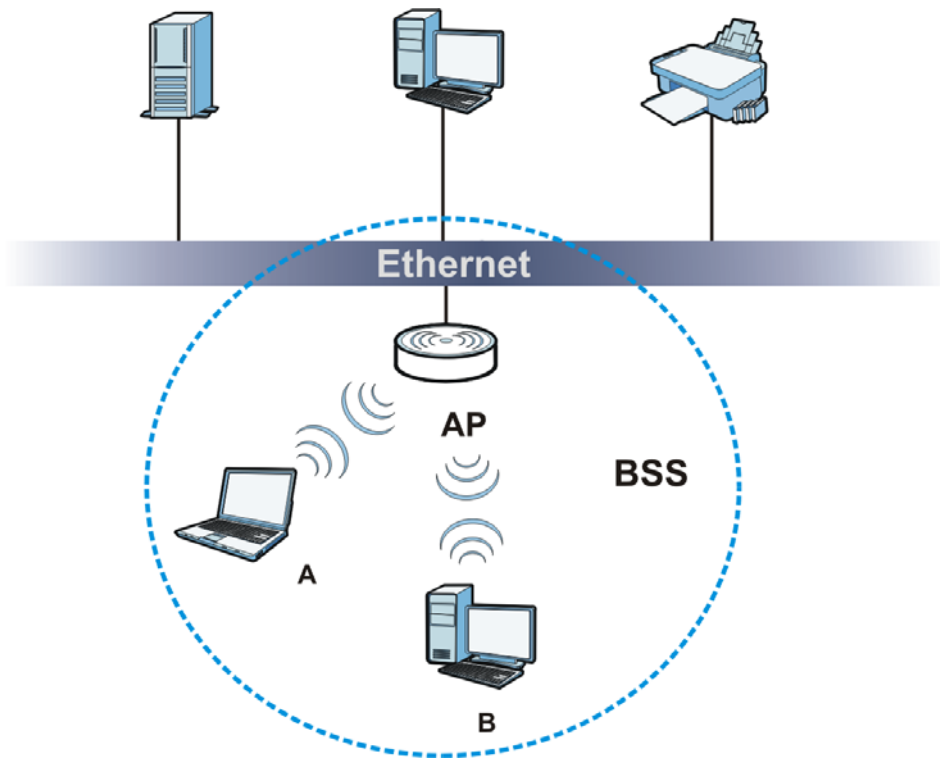
Figure 143 Basic Service Set

ESS

An Extended Service Set (ESS) consists of a series of overlapping BSSs, each containing an access point, with each access point connected together by a wired network. This wired connection between APs is called a Distribution System (DS).

This type of wireless LAN topology is called an Infrastructure WLAN. The Access Points not only provide communication with the wired network but also mediate wireless network traffic in the immediate neighborhood.

An ESSID (ESS Identification) uniquely identifies each ESS. All access points and their associated wireless clients within the same ESS must have the same ESSID in order to communicate.

Figure 144 Infrastructure WLAN

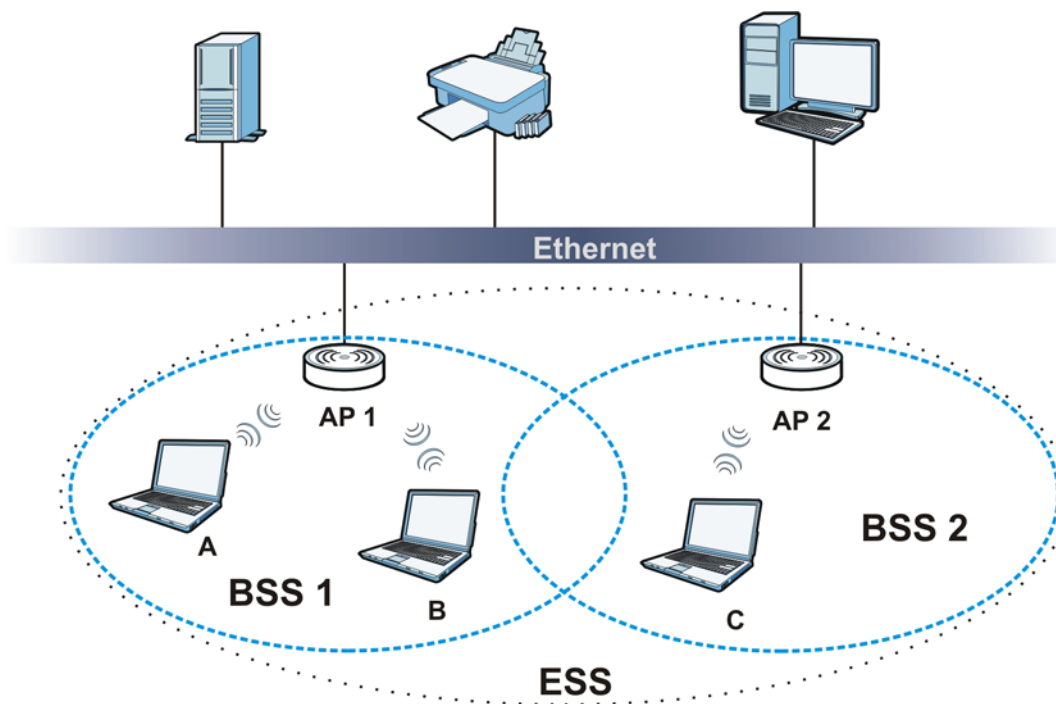

Channel

A channel is the radio frequency(ies) used by wireless devices to transmit and receive data. Channels available depend on your geographical area. You may have a choice of channels (for your region) so you should use a channel different from an adjacent AP (access point) to reduce interference. Interference occurs when radio signals from different access points overlap causing interference and degrading performance.

Adjacent channels partially overlap however. To avoid interference due to overlap, your AP should be on a channel at least five channels away from a channel that an adjacent AP is using. For example, if your region has 11 channels and an adjacent AP is using channel 1, then you need to select a channel between 6 or 11.

RTS/CTS

A hidden node occurs when two stations are within range of the same access point, but are not within range of each other. The following figure illustrates a hidden node. Both stations (STA) are within range of the access point (AP) or wireless gateway, but out-of-range of each other, so they cannot "hear" each other, that is they do not know if the channel is currently being used. Therefore, they are considered hidden from each other.

Figure 145 RTS/CTS

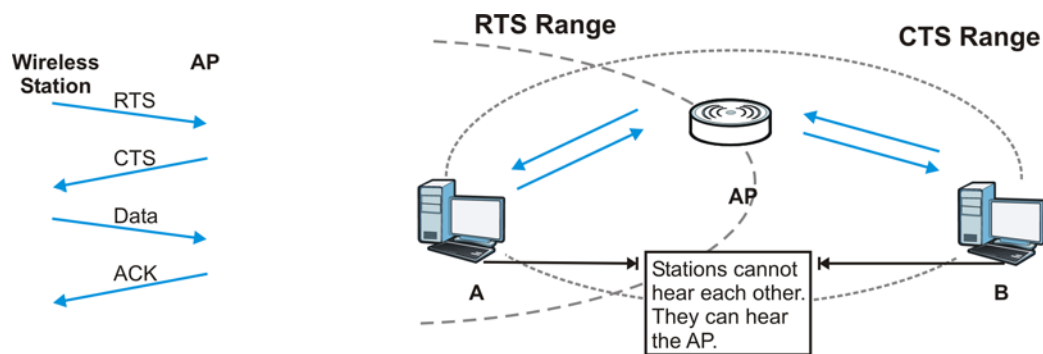

When station **A** sends data to the AP, it might not know that the station **B** is already using the channel. If these two stations send data at the same time, collisions may occur when both sets of data arrive at the AP at the same time, resulting in a loss of messages for both stations.

RTS/CTS is designed to prevent collisions due to hidden nodes. An **RTS/CTS** defines the biggest size data frame you can send before an RTS (Request To Send)/CTS (Clear to Send) handshake is invoked.

When a data frame exceeds the **RTS/CTS** value you set, the station that wants to transmit this frame must first send an RTS (Request To Send) message to the AP for permission to send it. The AP then responds with a CTS (Clear to Send) message to all other stations within its range to notify them to defer their transmission. It also reserves and confirms with the requesting station the time frame for the requested transmission.

Stations can send frames smaller than the specified **RTS/CTS** directly to the AP without the RTS (Request To Send)/CTS (Clear to Send) handshake.

You should only configure **RTS/CTS** if the possibility of hidden nodes exists on your network and the "cost" of resending large frames is more than the extra network overhead involved in the RTS (Request To Send)/CTS (Clear to Send) handshake.

If the **RTS/CTS** value is greater than the **Fragmentation Threshold** value (see next), then the RTS (Request To Send)/CTS (Clear to Send) handshake will never occur as data frames will be fragmented before they reach **RTS/CTS** size.

Note: Enabling the RTS Threshold causes redundant network overhead that could negatively affect the throughput performance instead of providing a remedy.

Fragmentation Threshold

A **Fragmentation Threshold** is the maximum data fragment size that can be sent in the wireless network before the AP will fragment the packet into smaller data frames.

A large **Fragmentation Threshold** is recommended for networks not prone to interference while you should set a smaller threshold for busy networks or networks that are prone to interference.

If the **Fragmentation Threshold** value is smaller than the **RTS/CTS** value (see previously) you set then the RTS (Request To Send)/CTS (Clear to Send) handshake will never occur as data frames will be fragmented before they reach **RTS/CTS** size.

Preamble Type

Preamble is used to signal that data is coming to the receiver. Short and long refer to the length of the synchronization field in a packet.

Short preamble increases performance as less time sending preamble means more time for sending data. All IEEE 802.11 compliant wireless adapters support long preamble, but not all support short preamble.

Use long preamble if you are unsure what preamble mode other wireless devices on the network support, and to provide more reliable communications in busy wireless networks.

Use short preamble if you are sure all wireless devices on the network support it, and to provide more efficient communications.

Use the dynamic setting to automatically use short preamble when all wireless devices on the network support it, otherwise the NBG uses long preamble.

Note: The wireless devices **MUST** use the same preamble mode in order to communicate.

Wireless Security Overview

Wireless security is vital to your network to protect wireless communication between wireless clients, access points and the wired network.

Wireless security methods available on the NBG are data encryption, wireless client authentication, restricting access by device MAC address and hiding the NBG identity.

The following figure shows the relative effectiveness of these wireless security methods available on your NBG.

Table 92 Wireless Security Levels

SECURITY LEVEL	SECURITY TYPE
Least Secure	Unique SSID (Default)
	Unique SSID with Hide SSID Enabled
	MAC Address Filtering
	WEP Encryption
	IEEE802.1x EAP with RADIUS Server Authentication
	Wi-Fi Protected Access (WPA)
	WPA2
Most Secure	

Note: You must enable the same wireless security settings on the NBG and on all wireless clients that you want to associate with it.

IEEE 802.1x

In June 2001, the IEEE 802.1x standard was designed to extend the features of IEEE 802.11 to support extended authentication as well as providing additional accounting and control features. It is supported by Windows XP and a number of network devices. Some advantages of IEEE 802.1x are:

- User based identification that allows for roaming.
- Support for RADIUS (Remote Authentication Dial In User Service, RFC 2138, 2139) for centralized user profile and accounting management on a network RADIUS server.
- Support for EAP (Extensible Authentication Protocol, RFC 2486) that allows additional authentication methods to be deployed with no changes to the access point or the wireless clients.

RADIUS

RADIUS is based on a client-server model that supports authentication, authorization and accounting. The access point is the client and the server is the RADIUS server. The RADIUS server handles the following tasks:

- Authentication
Determines the identity of the users.
- Authorization
Determines the network services available to authenticated users once they are connected to the network.
- Accounting
Keeps track of the client's network activity.

RADIUS is a simple package exchange in which your AP acts as a message relay between the wireless client and the network RADIUS server.

Types of RADIUS Messages

The following types of RADIUS messages are exchanged between the access point and the RADIUS server for user authentication:

- Access-Request
Sent by an access point requesting authentication.
- Access-Reject
Sent by a RADIUS server rejecting access.
- Access-Accept
Sent by a RADIUS server allowing access.
- Access-Challenge
Sent by a RADIUS server requesting more information in order to allow access. The access point sends a proper response from the user and then sends another Access-Request message.

The following types of RADIUS messages are exchanged between the access point and the RADIUS server for user accounting:

- Accounting-Request
Sent by the access point requesting accounting.
- Accounting-Response
Sent by the RADIUS server to indicate that it has started or stopped accounting.

In order to ensure network security, the access point and the RADIUS server use a shared secret key, which is a password, they both know. The key is not sent over the network. In addition to the shared key, password information exchanged is also encrypted to protect the network from unauthorized access.

Types of EAP Authentication

This section discusses some popular authentication types: EAP-MD5, EAP-TLS, EAP-TTLS, PEAP and LEAP. Your wireless LAN device may not support all authentication types.

EAP (Extensible Authentication Protocol) is an authentication protocol that runs on top of the IEEE 802.1x transport mechanism in order to support multiple types of user authentication. By using EAP to interact with an EAP-compatible RADIUS server, an access point helps a wireless station and a RADIUS server perform authentication.

The type of authentication you use depends on the RADIUS server and an intermediary AP(s) that supports IEEE 802.1x. .

For EAP-TLS authentication type, you must first have a wired connection to the network and obtain the certificate(s) from a certificate authority (CA). A certificate (also called digital IDs) can be used to authenticate users and a CA issues certificates and guarantees the identity of each certificate owner.

EAP-MD5 (Message-Digest Algorithm 5)

MD5 authentication is the simplest one-way authentication method. The authentication server sends a challenge to the wireless client. The wireless client 'proves' that it knows the password by encrypting the password with the challenge and sends back the information. Password is not sent in plain text.

However, MD5 authentication has some weaknesses. Since the authentication server needs to get the plaintext passwords, the passwords must be stored. Thus someone other than the authentication server may access the password file. In addition, it is possible to impersonate an authentication server as MD5 authentication method does not perform mutual authentication. Finally, MD5 authentication method does not support data encryption with dynamic session key. You must configure WEP encryption keys for data encryption.

EAP-TLS (Transport Layer Security)

With EAP-TLS, digital certifications are needed by both the server and the wireless clients for mutual authentication. The server presents a certificate to the client. After validating the identity of the server, the client sends a different certificate to the server. The exchange of certificates is done in the open before a secured tunnel is created. This makes user identity vulnerable to passive attacks. A digital certificate is an electronic ID card that authenticates the sender's identity. However, to implement EAP-TLS, you need a Certificate Authority (CA) to handle certificates, which imposes a management overhead.

EAP-TTLS (Tunneled Transport Layer Service)

EAP-TTLS is an extension of the EAP-TLS authentication that uses certificates for only the server-side authentications to establish a secure connection. Client authentication is then done by sending username and password through the secure connection, thus client identity is protected. For client authentication, EAP-TTLS supports EAP methods and legacy authentication methods such as PAP, CHAP, MS-CHAP and MS-CHAP v2.

PEAP (Protected EAP)

Like EAP-TTLS, server-side certificate authentication is used to establish a secure connection, then use simple username and password methods through the secured connection to authenticate the clients, thus hiding client identity. However, PEAP only supports EAP methods, such as EAP-MD5, EAP-MSCHAPv2 and EAP-GTC (EAP-Generic Token Card), for client authentication. EAP-GTC is implemented only by Cisco.

LEAP

LEAP (Lightweight Extensible Authentication Protocol) is a Cisco implementation of IEEE 802.1x.

Dynamic WEP Key Exchange

The AP maps a unique key that is generated with the RADIUS server. This key expires when the wireless connection times out, disconnects or reauthentication times out. A new WEP key is generated each time reauthentication is performed.

If this feature is enabled, it is not necessary to configure a default encryption key in the wireless security configuration screen. You may still configure and store keys, but they will not be used while dynamic WEP is enabled.

Note: EAP-MD5 cannot be used with Dynamic WEP Key Exchange

For added security, certificate-based authentications (EAP-TLS, EAP-TTLS and PEAP) use dynamic keys for data encryption. They are often deployed in corporate environments, but for public deployment, a simple user name and password pair is more practical. The following table is a comparison of the features of authentication types.

Table 93 Comparison of EAP Authentication Types

	EAP-MD5	EAP-TLS	EAP-TTLS	PEAP	LEAP
Mutual Authentication	No	Yes	Yes	Yes	Yes
Certificate – Client	No	Yes	Optional	Optional	No
Certificate – Server	No	Yes	Yes	Yes	No
Dynamic Key Exchange	No	Yes	Yes	Yes	Yes
Credential Integrity	None	Strong	Strong	Strong	Moderate
Deployment Difficulty	Easy	Hard	Moderate	Moderate	Moderate
Client Identity Protection	No	No	Yes	Yes	No

WPA and WPA2

Wi-Fi Protected Access (WPA) is a subset of the IEEE 802.11i standard. WPA2 (IEEE 802.11i) is a wireless security standard that defines stronger encryption, authentication and key management than WPA.

Key differences between WPA or WPA2 and WEP are improved data encryption and user authentication.

If both an AP and the wireless clients support WPA2 and you have an external RADIUS server, use WPA2 for stronger data encryption. If you don't have an external RADIUS server, you should use WPA2-PSK (WPA2-Pre-Shared Key) that only requires a single (identical) password entered into each access point, wireless gateway and wireless client. As long as the passwords match, a wireless client will be granted access to a WLAN.

If the AP or the wireless clients do not support WPA2, just use WPA or WPA-PSK depending on whether you have an external RADIUS server or not.

Select WEP only when the AP and/or wireless clients do not support WPA or WPA2. WEP is less secure than WPA or WPA2.

Encryption

WPA improves data encryption by using Temporal Key Integrity Protocol (TKIP), Message Integrity Check (MIC) and IEEE 802.1x. WPA2 also uses TKIP when required for compatibility reasons, but offers stronger encryption than TKIP with Advanced Encryption Standard (AES) in the Counter mode with Cipher block chaining Message authentication code Protocol (CCMP).

TKIP uses 128-bit keys that are dynamically generated and distributed by the authentication server. AES (Advanced Encryption Standard) is a block cipher that uses a 256-bit mathematical algorithm called Rijndael. They both include a per-packet key mixing function, a Message Integrity Check (MIC) named Michael, an extended initialization vector (IV) with sequencing rules, and a re-keying mechanism.

WPA and WPA2 regularly change and rotate the encryption keys so that the same encryption key is never used twice.

The RADIUS server distributes a Pairwise Master Key (PMK) key to the AP that then sets up a key hierarchy and management system, using the PMK to dynamically generate unique data encryption keys to encrypt every data packet that is wirelessly communicated between the AP and the wireless clients. This all happens in the background automatically.

The Message Integrity Check (MIC) is designed to prevent an attacker from capturing data packets, altering them and resending them. The MIC provides a strong mathematical function in which the receiver and the transmitter each compute and then compare the MIC. If they do not match, it is assumed that the data has been tampered with and the packet is dropped.

By generating unique data encryption keys for every data packet and by creating an integrity checking mechanism (MIC), with TKIP and AES it is more difficult to decrypt data on a Wi-Fi network than WEP and difficult for an intruder to break into the network.

The encryption mechanisms used for WPA(2) and WPA(2)-PSK are the same. The only difference between the two is that WPA(2)-PSK uses a simple common password, instead of user-specific credentials. The common-password approach makes WPA(2)-PSK susceptible to brute-force

password-guessing attacks but it's still an improvement over WEP as it employs a consistent, single, alphanumeric password to derive a PMK which is used to generate unique temporal encryption keys. This prevents all wireless devices sharing the same encryption keys. (a weakness of WEP)

User Authentication

WPA and WPA2 apply IEEE 802.1x and Extensible Authentication Protocol (EAP) to authenticate wireless clients using an external RADIUS database. WPA2 reduces the number of key exchange messages from six to four (CCMP 4-way handshake) and shortens the time required to connect to a network. Other WPA2 authentication features that are different from WPA include key caching and pre-authentication. These two features are optional and may not be supported in all wireless devices.

Key caching allows a wireless client to store the PMK it derived through a successful authentication with an AP. The wireless client uses the PMK when it tries to connect to the same AP and does not need to go through the authentication process again.

Pre-authentication enables fast roaming by allowing the wireless client (already connecting to an AP) to perform IEEE 802.1x authentication with another AP before connecting to it.

Wireless Client WPA Supplicants

A wireless client supplicant is the software that runs on an operating system instructing the wireless client how to use WPA. At the time of writing, the most widely available supplicant is the WPA patch for Windows XP, Funk Software's Odyssey client.

The Windows XP patch is a free download that adds WPA capability to Windows XP's built-in "Zero Configuration" wireless client. However, you must run Windows XP to use it.

WPA(2) with RADIUS Application Example

To set up WPA(2), you need the IP address of the RADIUS server, its port number (default is 1812), and the RADIUS shared secret. A WPA(2) application example with an external RADIUS server looks as follows. "A" is the RADIUS server. "DS" is the distribution system.

- 1 The AP passes the wireless client's authentication request to the RADIUS server.
- 2 The RADIUS server then checks the user's identification against its database and grants or denies network access accordingly.
- 3 A 256-bit Pairwise Master Key (PMK) is derived from the authentication process by the RADIUS server and the client.
- 4 The RADIUS server distributes the PMK to the AP. The AP then sets up a key hierarchy and management system, using the PMK to dynamically generate unique data encryption keys. The keys are used to encrypt every data packet that is wirelessly communicated between the AP and the wireless clients.

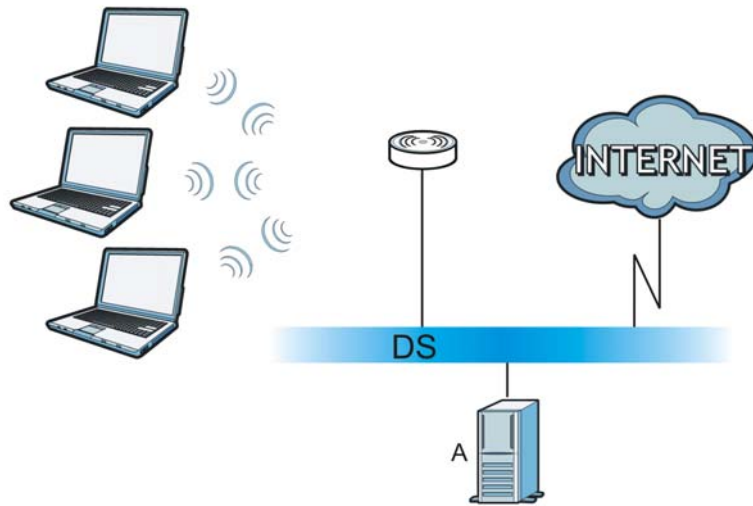
Figure 146 WPA(2) with RADIUS Application Example

WPA(2)-PSK Application Example

A WPA(2)-PSK application looks as follows.

- 1 First enter identical passwords into the AP and all wireless clients. The Pre-Shared Key (PSK) must consist of between 8 and 63 ASCII characters or 64 hexadecimal characters (including spaces and symbols).
- 2 The AP checks each wireless client's password and allows it to join the network only if the password matches.
- 3 The AP and wireless clients generate a common PMK (Pairwise Master Key). The key itself is not sent over the network, but is derived from the PSK and the SSID.
- 4 The AP and wireless clients use the TKIP or AES encryption process, the PMK and information exchanged in a handshake to create temporal encryption keys. They use these keys to encrypt data exchanged between them.

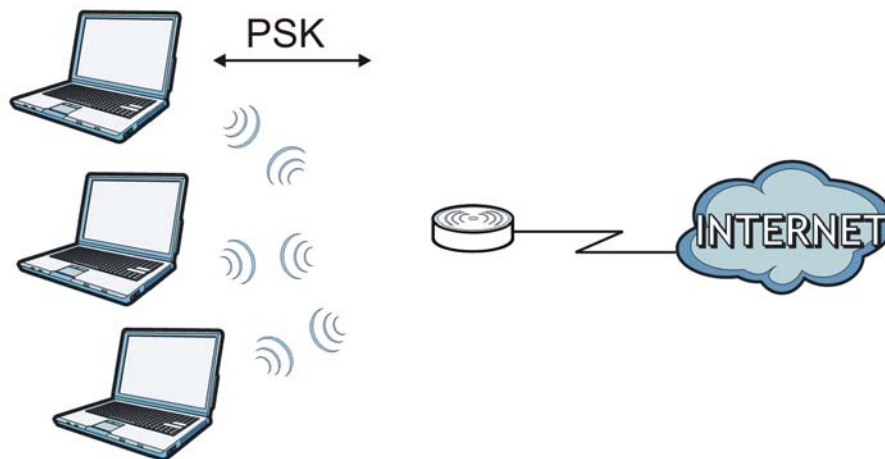
Figure 147 WPA(2)-PSK Authentication

Security Parameters Summary

Refer to this table to see what other security parameters you should configure for each authentication method or key management protocol type. MAC address filters are not dependent on how you configure these security features.

Table 94 Wireless Security Relational Matrix

AUTHENTICATION METHOD/ KEY MANAGEMENT PROTOCOL	ENCRYPTION METHOD	ENTER MANUAL KEY	IEEE 802.1X
Open	None	No	Disable
			Enable without Dynamic WEP Key
Open	WEP	No	Enable with Dynamic WEP Key
		Yes	Enable without Dynamic WEP Key
		Yes	Disable
Shared	WEP	No	Enable with Dynamic WEP Key
		Yes	Enable without Dynamic WEP Key
		Yes	Disable
WPA	TKIP/AES	No	Enable
WPA-PSK	TKIP/AES	Yes	Disable
WPA2	TKIP/AES	No	Enable
WPA2-PSK	TKIP/AES	Yes	Disable

Antenna Overview

An antenna couples RF signals onto air. A transmitter within a wireless device sends an RF signal to the antenna, which propagates the signal through the air. The antenna also operates in reverse by capturing RF signals from the air.

Positioning the antennas properly increases the range and coverage area of a wireless LAN.

Antenna Characteristics

Frequency

An antenna in the frequency of 2.4GHz or 5GHz is needed to communicate efficiently in a wireless LAN

Radiation Pattern

A radiation pattern is a diagram that allows you to visualize the shape of the antenna's coverage area.

Antenna Gain

Antenna gain, measured in dB (decibel), is the increase in coverage within the RF beam width. Higher antenna gain improves the range of the signal for better communications.

For an indoor site, each 1 dB increase in antenna gain results in a range increase of approximately 2.5%. For an unobstructed outdoor site, each 1dB increase in gain results in a range increase of approximately 5%. Actual results may vary depending on the network environment.

Antenna gain is sometimes specified in dBi, which is how much the antenna increases the signal power compared to using an isotropic antenna. An isotropic antenna is a theoretical perfect antenna that sends out radio signals equally well in all directions. dBi represents the true gain that the antenna provides.

Types of Antennas for WLAN

There are two types of antennas used for wireless LAN applications.

- Omni-directional antennas send the RF signal out in all directions on a horizontal plane. The coverage area is torus-shaped (like a donut) which makes these antennas ideal for a room environment. With a wide coverage area, it is possible to make circular overlapping coverage areas with multiple access points.
- Directional antennas concentrate the RF signal in a beam, like a flashlight does with the light from its bulb. The angle of the beam determines the width of the coverage pattern. Angles typically range from 20 degrees (very directional) to 120 degrees (less directional). Directional antennas are ideal for hallways and outdoor point-to-point applications.

Positioning Antennas

In general, antennas should be mounted as high as practically possible and free of obstructions. In point-to-point application, position both antennas at the same height and in a direct line of sight to each other to attain the best performance.

For omni-directional antennas mounted on a table, desk, and so on, point the antenna up. For omni-directional antennas mounted on a wall or ceiling, point the antenna down. For a single AP application, place omni-directional antennas as close to the center of the coverage area as possible.

For directional antennas, point the antenna in the direction of the desired coverage area.

Common Services

The following table lists some commonly-used services and their associated protocols and port numbers. For a comprehensive list of port numbers, ICMP type/code numbers and services, visit the IANA (Internet Assigned Number Authority) web site.

- **Name:** This is a short, descriptive name for the service. You can use this one or create a different one, if you like.
- **Protocol:** This is the type of IP protocol used by the service. If this is **TCP/UDP**, then the service uses the same port number with TCP and UDP. If this is **USER-DEFINED**, the **Port(s)** is the IP protocol number, not the port number.
- **Port(s):** This value depends on the **Protocol**. Please refer to RFC 1700 for further information about port numbers.
 - If the **Protocol** is **TCP, UDP, or TCP/UDP**, this is the IP port number.
 - If the **Protocol** is **USER**, this is the IP protocol number.
- **Description:** This is a brief explanation of the applications that use this service or the situations in which this service is used.

Table 95 Commonly Used Services

NAME	PROTOCOL	PORT(S)	DESCRIPTION
AH (IPSEC_TUNNEL)	User-Defined	51	The IPSEC AH (Authentication Header) tunneling protocol uses this service.
AIM/New-ICQ	TCP	5190	AOL's Internet Messenger service. It is also used as a listening port by ICQ.
AUTH	TCP	113	Authentication protocol used by some servers.
BGP	TCP	179	Border Gateway Protocol.
BOOTP_CLIENT	UDP	68	DHCP Client.
BOOTP_SERVER	UDP	67	DHCP Server.
CU-SEEME	TCP UDP	7648 24032	A popular videoconferencing solution from White Pines Software.
DNS	TCP/UDP	53	Domain Name Server, a service that matches web names (for example www.zyxel.com) to IP numbers.
ESP (IPSEC_TUNNEL)	User-Defined	50	The IPSEC ESP (Encapsulation Security Protocol) tunneling protocol uses this service.
FINGER	TCP	79	Finger is a UNIX or Internet related command that can be used to find out if a user is logged on.
FTP	TCP TCP	20 21	File Transfer Program, a program to enable fast transfer of files, including large files that may not be possible by e-mail.
H.323	TCP	1720	NetMeeting uses this protocol.

Table 95 Commonly Used Services (continued)

NAME	PROTOCOL	PORT(S)	DESCRIPTION
HTTP	TCP	80	Hyper Text Transfer Protocol - a client/server protocol for the world wide web.
HTTPS	TCP	443	HTTPS is a secured http session often used in e-commerce.
ICMP	User-Defined	1	Internet Control Message Protocol is often used for diagnostic or routing purposes.
ICQ	UDP	4000	This is a popular Internet chat program.
IGMP (MULTICAST)	User-Defined	2	Internet Group Management Protocol is used when sending packets to a specific group of hosts.
IKE	UDP	500	The Internet Key Exchange algorithm is used for key distribution and management.
IRC	TCP/UDP	6667	This is another popular Internet chat program.
MSN Messenger	TCP	1863	Microsoft Networks' messenger service uses this protocol.
NEW-ICQ	TCP	5190	An Internet chat program.
NEWS	TCP	144	A protocol for news groups.
NFS	UDP	2049	Network File System - NFS is a client/server distributed file service that provides transparent file sharing for network environments.
NNTP	TCP	119	Network News Transport Protocol is the delivery mechanism for the USENET newsgroup service.
PING	User-Defined	1	Packet Internet Groper is a protocol that sends out ICMP echo requests to test whether or not a remote host is reachable.
POP3	TCP	110	Post Office Protocol version 3 lets a client computer get e-mail from a POP3 server through a temporary connection (TCP/IP or other).
PPTP	TCP	1723	Point-to-Point Tunneling Protocol enables secure transfer of data over public networks. This is the control channel.
PPTP_TUNNEL (GRE)	User-Defined	47	PPTP (Point-to-Point Tunneling Protocol) enables secure transfer of data over public networks. This is the data channel.
RCMD	TCP	512	Remote Command Service.
REAL_AUDIO	TCP	7070	A streaming audio service that enables real time sound over the web.
REXEC	TCP	514	Remote Execution Daemon.
RLOGIN	TCP	513	Remote Login.
RTELNET	TCP	107	Remote Telnet.
RTSP	TCP/UDP	554	The Real Time Streaming (media control) Protocol (RTSP) is a remote control for multimedia on the Internet.
SFTP	TCP	115	Simple File Transfer Protocol.

Table 95 Commonly Used Services (continued)

NAME	PROTOCOL	PORT(S)	DESCRIPTION
SMTP	TCP	25	Simple Mail Transfer Protocol is the message-exchange standard for the Internet. SMTP enables you to move messages from one e-mail server to another.
SNMP	TCP/UDP	161	Simple Network Management Program.
SNMP-TRAPS	TCP/UDP	162	Traps for use with the SNMP (RFC:1215).
SQL-NET	TCP	1521	Structured Query Language is an interface to access data on many different types of database systems, including mainframes, midrange systems, UNIX systems and network servers.
SSH	TCP/UDP	22	Secure Shell Remote Login Program.
STRM WORKS	UDP	1558	Stream Works Protocol.
SYSLOG	UDP	514	Syslog allows you to send system logs to a UNIX server.
TACACS	UDP	49	Login Host Protocol used for (Terminal Access Controller Access Control System).
TELNET	TCP	23	Telnet is the login and terminal emulation protocol common on the Internet and in UNIX environments. It operates over TCP/IP networks. Its primary function is to allow users to log into remote host systems.
TFTP	UDP	69	Trivial File Transfer Protocol is an Internet file transfer protocol similar to FTP, but uses the UDP (User Datagram Protocol) rather than TCP (Transmission Control Protocol).
VDOLIVE	TCP	7000	Another videoconferencing solution.

Legal Information

Copyright

Copyright © 2016 by ZyxEL Communications Corporation.

The contents of this publication may not be reproduced in any part or as a whole, transcribed, stored in a retrieval system, translated into any language, or transmitted in any form or by any means, electronic, mechanical, magnetic, optical, chemical, photocopying, manual, or otherwise, without the prior written permission of ZyxEL Communications Corporation.

Published by ZyxEL Communications Corporation. All rights reserved.

Disclaimer

ZyxEL does not assume any liability arising out of the application or use of any products, or software described herein. Neither does it convey any license under its patent rights nor the patent rights of others. ZyxEL further reserves the right to make changes in any products described herein without notice. This publication is subject to change without notice.

Regulatory Notice and Statement

UNITED STATES of AMERICA



The following information applies if you use the product within USA area.

FCC EMC Statement

- The device complies with Part 15 of FCC rules. Operation is subject to the following two conditions:
 - (1) This device may not cause harmful interference, and
 - (2) This device must accept any interference received, including interference that may cause undesired operation.
- Changes or modifications not expressly approved by the party responsible for compliance could void the user's authority to operate the device.
- This product has been tested and complies with the specifications for a Class B digital device, pursuant to Part 15 of the FCC Rules. These limits are designed to provide reasonable protection against harmful interference in a residential installation. This device generates, uses, and can radiate radio frequency energy and, if not installed and used according to the instructions, may cause harmful interference to radio communications. However, there is no guarantee that interference will not occur in a particular installation.
- If this device does cause harmful interference to radio or television reception, which is found by turning the device off and on, the user is encouraged to try to correct the interference by one or more of the following measures:
 - Reorient or relocate the receiving antenna
 - Increase the separation between the devices
 - Connect the equipment to an outlet other than the receiver's
 - Consult a dealer or an experienced radio/TV technician for assistance

FCC Radiation Exposure Statement

- This device complies with FCC RF radiation exposure limits set forth for an uncontrolled environment. This transmitter must be at least 20 cm from the user and must not be co-located or operating in conjunction with any other antenna or transmitter.

CANADA

The following information applies if you use the product within Canada area

Industry Canada ICES statement

ICAN ICES-3 (B)/NMB-3(B)

Industry Canada RSS-GEN & RSS-247 statement

- This device complies with Industry Canada license-exempt RSS standard(s). Operation is subject to the following two conditions: (1) this device may not cause interference, and (2) this device must accept any interference, including interference that may cause undesired operation of the device.
- This radio transmitter (2468C-NBG6515) has been approved by Industry Canada to operate with the antenna types listed below with the maximum permissible gain and required antenna impedance for each antenna type indicated. Antenna types not included in this list, having a gain greater than the maximum gain indicated for that type, are strictly prohibited for use with this device.

Antenna Information

TYPE	MANUFACTURER	GAIN	CONNECTOR
External	Aristotle	2.4GHz – 3dBi	i-pex
		5GHz – 5dBi	

If the product with 5G wireless function operating in 5150-5250 MHz and 5725-5850 MHz , the following attention must be paid,

- The device for operation in the band 5150-5250 MHz is only for indoor use to reduce the potential for harmful interference to co-channel mobile satellite systems.
- For devices with detachable antenna(s), the maximum antenna gain permitted for devices in the band 5725-5850 MHz shall be such that the equipment still complies with the e.i.r.p. limits specified for point-to-point and non-point-to-point operation as appropriate; and
- The worst-case tilt angle(s) necessary to remain compliant with the e.i.r.p. elevation mask requirement set forth in Section 6.2.2(3) of RSS 247 shall be clearly indicated.

If the product with 5G wireless function operating in 5250-5350 MHz and 5470-5725 MHz , the following attention must be paid.

- For devices with detachable antenna(s), the maximum antenna gain permitted for devices in the bands 5250-5350 MHz and 5470-5725 MHz shall be such that the equipment still complies with the e.i.r.p. limit
- Le présent appareil est conforme aux CNR d'Industrie Canada applicables aux appareils radio exempts de licence. L'exploitation est autorisée aux deux conditions suivantes : (1) l'appareil ne doit pas produire de brouillage, et (2) l'utilisateur de l'appareil doit accepter tout brouillage radioélectrique subi, même si le brouillage est susceptible d'en compromettre le fonctionnement.
- Le présent émetteur radio (2468C-NBG6515) de modèle s'il fait partie du matériel de catégorie I) a été approuvé par Industrie Canada pour fonctionner avec les types d'antenne énumérés ci-dessous et ayant un gain admissible maximal et l'impédance requise pour chaque type d'antenne. Les types d'antenne non inclus dans cette liste, ou dont le gain est supérieur au gain maximal indiqué, sont strictement interdits pour l'exploitation de l'émetteur.

Informations Antenne

TYPE	FABRICANT	GAIN	CONNECTEUR
External	Aristotle	2.4GHz – 3dBi	i-pex
		5GHz – 5dBi	

Lorsque la fonction sans fil 5G fonctionnant en 5150-5250 MHz and 5725-5850 MHz est activée pour ce produit , il est nécessaire de porter une attention particulière aux choses suivantes

- Les dispositifs fonctionnant dans la bande 5150-5250 MHz sont réservés uniquement pour une utilisation à l'intérieur afin de réduire les risques de brouillage préjudiciable aux systèmes de satellites mobiles utilisant les mêmes canaux;
- Pour les dispositifs munis d'antennes amovibles, le gain maximal d'antenne permis (pour les dispositifs utilisant la bande de 5 725 à 5 850 MHz) doit être conforme à la limite de la p.i.r.e. spécifiée pour l'exploitation point à point et l'exploitation non point à point, selon le cas;
- Les pires angles d'inclinaison nécessaires pour rester conforme à l'exigence de la p.i.r.e. applicable au masque d'élévation, et énoncée à la section 6.2.2 3) du CNR-247, doivent être clairement indiqués.

Lorsque la fonction sans fil 5G fonctionnant en 5250-5350 MHz et 5470-5725 MHz est activée pour ce produit , il est nécessaire de porter une attention particulière aux choses suivantes

- Pour les dispositifs munis d'antennes amovibles, le gain maximal d'antenne permis pour les dispositifs utilisant les bandes de 5 250 à 5 350 MHz et de 5 470 à 5 725 MHz doit être conforme à la limite de la p.i.r.e.

Industry Canada radiation exposure statement

This device complies with IC radiation exposure limits set forth for an uncontrolled environment. This device should be installed and operated with a minimum distance of 20 cm between the radiator and your body.

Déclaration d'exposition aux radiations:

Cet équipement est conforme aux limites d'exposition aux rayonnements IC établies pour un environnement non contrôlé. Cet équipement doit être installé et utilisé avec un minimum de 20 cm de distance entre la source de rayonnement et votre corps.

EUROPEAN UNION



The following information applies if you use the product within the European Union.

Declaration of Conformity with Regard to EU Directive 1999/5/EC (R&TTE Directive)

Compliance information for 2.4GHz and/or 5GHz wireless products relevant to the EU and other Countries following the EU Directive 1999/5/EC (R&TTE)

Български (Bulgarian)	С настоящото ZyXEL декларира, че това оборудване е в съответствие със съществените изисквания и другите приложими разпоредбите на Директива 1999/5/EC.
Español (Spanish)	Por medio de la presente ZyXEL declara que el equipo cumple con los requisitos esenciales y cualesquiera otras disposiciones aplicables o exigibles de la Directiva 1999/5/CE.
Čeština (Czech)	ZyXEL tímto prohlašuje, že tento zařizení je ve shodě se základními požadavky a dalšími příslušnými ustanoveními směrnice 1999/5/EC.
Dansk (Danish)	Undertegnede ZyXEL erklærer herved, at følgende udstyr overholder de væsentlige krav og øvrige relevante krav i direktiv 1999/5/EF.
Deutsch (German)	Hiermit erkläre ZyXEL, dass sich das Gerät Ausstattung in Übereinstimmung mit den grundlegenden Anforderungen und den übrigen einschlägigen Bestimmungen der Richtlinie 1999/5/EU befindet.
Eesti keel (Estonian)	Käesolevaga kinnitab ZyXEL seadme seadmed vastavust direktiivi 1999/5/EÜ põhinõuetele ja nimetatud direktiivist tulenevatele teistele asjakohastele sätetele.
Ελληνικά (Greek)	ΜΕ ΤΗΝ ΠΑΡΟΥΣΑ ΖΥΧΕΛ ΔΗΛΩΝΕΙ ΟΤΙ ΕΞΟΠΛΙΣΜΟΣ ΣΥΜΜΟΡΦΩΝΕΤΑΙ ΠΡΟΣ ΤΙΣ ΟΥΣΙΩΔΕΙΣ ΑΠΑΙΤΗΣΕΙΣ ΚΑΙ ΤΙΣ ΛΟΙΠΕΣ ΣΧΕΤΙΚΕΣ ΔΙΑΤΑΞΕΙΣ ΤΗΣ ΟΔΗΓΙΑΣ 1999/5/ΕΚ.
English	Hereby, ZyXEL declares that this device is in compliance with the essential requirements and other relevant provisions of Directive 1999/5/EC.
Français (French)	Par la présente ZyXEL déclare que l'appareil équipements est conforme aux exigences essentielles et aux autres dispositions pertinentes de la directive 1999/5/EC.
Hrvatski (Croatian)	ZyXEL ovime izjavljuje da je radijska oprema tipa u skladu s Direktivom 1999/5/EC.
Íslenska (Icelandic)	Hér með lýsir, ZyXEL því yfir að þessi búnaður er í samræmi við grunnkröfur og önnur viðeigandi ákvæði tilskipunar 1999/5/EC.
Italiano (Italian)	Con la presente ZyXEL dichiara che questo attrezzatura è conforme ai requisiti essenziali ed alle altre disposizioni pertinenti stabilite dalla direttiva 1999/5/CE.
Latviešu valoda (Latvian)	Ar šo ZyXEL deklarē, ka iekārtas atbilst Direktīvas 1999/5/EK būtiskajām prasībām un citiem ar to saistītajiem noteikumiem.
Lietuvių kalba (Lithuanian)	Šiuo ZyXEL deklaruoja, kad šis įranga atitinka esminius reikalavimus ir kitas 1999/5/EB Direktyvos nuostatas.
Magyar (Hungarian)	Alulírott, ZyXEL nyilatkozom, hogy a berendezés megfelel a vonatkozó alapvető követelményeknek és az 1999/5/EK irányelv egyéb előírásainak.
Malti (Maltese)	Hawnhekk, ZyXEL, jiddikjara li dan taghmir jikkonforma mal-htigijiet essenzjali u ma provvedimenti oħrajn relevanti li hemm fid-Dirrettiva 1999/5/EC.
Nederlands (Dutch)	Hierbij verklaart ZyXEL dat het toestel uitrusting in overeenstemming is met de essentiële eisen en de andere relevante bepalingen van richtlijn 1999/5/EC.
Polski (Polish)	Niniejszym ZyXEL oświadcza, że sprzęt jest zgodny z zasadniczymi wymogami oraz pozostałymi stosownymi postanowieniami Dyrektywy 1999/5/EC.
Português (Portuguese)	ZyXEL declara que este equipamento está conforme com os requisitos essenciais e outras disposições da Directiva 1999/5/EC.
Română (Romanian)	Prin prezenta, ZyXEL declară că acest echipament este în conformitate cu cerințele esențiale și alte prevederi relevante ale Directivei 1999/5/EC.
Slovenčina (Slovak)	ZyXEL týmto vyhlasuje, že zariadenia spĺňa základné požiadavky a všetky príslušné ustanovenia Smernice 1999/5/EC.
Slovenščina (Slovene)	ZyXEL izjavlja, da je ta oprema v skladu z bistvenimi zahtevami in ostalimi relevantnimi določili direktive 1999/5/EC.
Suomi (Finnish)	ZyXEL vakuuttaa täten että laitteet tyyppinen laite on direktiivin 1999/5/EY oleellisten vaatimusten ja sitä koskevien direktiivin muiden ehtojen mukainen.

Svenska (Swedish)	Härmed intygar ZyXEL att denna utrustning står i överensstämmelse med de väsentliga egenskapskrav och övriga relevanta bestämmelser som framgår av direktiv 1999/5/EC.
Norsk (Norwegian)	Erklærer herved ZyXEL at dette utstyret er i samsvar med de grunnleggende kravene og andre relevante bestemmelser i direktiv 1999/5/EF.

This device is restricted to indoor use only when operating in the 5150 to 5350 MHz frequency range.

National Restrictions

This product may be used in all EU countries (and other countries following the EU Directive 1999/5/EC) without any limitation except for the countries mentioned below:

Ce produit peut être utilisé dans tous les pays de l'UE (et dans tous les pays ayant transposés la directive 1999/5/CE) sans aucune limitation, excepté pour les pays mentionnés ci-dessous:

Questo prodotto è utilizzabile in tutte i paesi EU (ed in tutti gli altri paesi che seguono le direttive 1999/5/EC) senza nessuna limitazione, eccetto per i paesi menzionati di seguito:

Das Produkt kann in allen EU Staaten ohne Einschränkungen eingesetzt werden (sowie in anderen Staaten die der Richtlinie 1999/5/CE folgen) mit Ausnahme der folgenden aufgeführten Staaten:

In the majority of the EU and other European countries, the 2.4GHz and 5GHz bands have been made available for the use of wireless local area networks (LANs). Later in this document you will find an overview of countries in which additional restrictions or requirements or both are applicable.

The requirements for any country may evolve. ZyXEL recommends that you check with the local authorities for the latest status of their national regulations for both the 2.4GHz and 5GHz wireless LANs.

The following countries have restrictions and/or requirements in addition to those given in the table labeled "Overview of Regulatory Requirements for Wireless LANs":.

Belgium

The Belgian Institute for Postal Services and Telecommunications (BIPT) must be notified of any outdoor wireless link having a range exceeding 300 meters. Please check <http://www.bipt.be> for more details.

Draadloze verbindingen voor buitengebruik en met een reikwijdte van meer dan 300 meter dienen aangemeld te worden bij het Belgisch Instituut voor postdiensten en telecommunicatie (BIPT). Zie <http://www.bipt.be> voor meer gegevens.

Les liaisons sans fil pour une utilisation en extérieur d'une distance supérieure à 300 mètres doivent être notifiées à l'Institut Belge des services Postaux et des Télécommunications (IBPT). Visitez <http://www.ibpt.be> pour de plus amples détails.

Denmark

In Denmark, the band 5150 - 5350 MHz is also allowed for outdoor usage.

I Danmark må frekvensbåndet 5150 - 5350 også anvendes udendørs.

Italy

This product meets the National Radio Interface and the requirements specified in the National Frequency Allocation Table for Italy. Unless this wireless LAN product is operating within the boundaries of the owner's property, its use requires a "general authorization." Please check <http://www.sviluppoeconomico.gov.it/> for more details.

Questo prodotto è conforme alla specifiche di Interfaccia Radio Nazionali e rispetta il Piano Nazionale di ripartizione delle frequenze in Italia. Se non viene installato all'interno del proprio fondo, l'utilizzo di prodotti Wireless LAN richiede una "Autorizzazione Generale". Consultare <http://www.sviluppoeconomico.gov.it/> per maggiori dettagli.

Latvia

The outdoor usage of the 2.4 GHz band requires an authorization from the Electronic Communications Office. Please check <http://www.esd.lv> for more details.

2.4 GHz frekvenču joslas izmantošanai ārpus telpām nepieciešama atļauja no Elektronisko sakaru direkcijas. Vairāk informācijas: <http://www.esd.lv>.

Notes:

1. Although Norway, Switzerland and Liechtenstein are not EU member states, the EU Directive 1999/5/EC has also been implemented in those countries.

2. The regulatory limits for maximum output power are specified in EIRP. The EIRP level (in dBm) of a device can be calculated by adding the gain of the antenna used (specified in dBi) to the output power available at the connector (specified in dBm).

List of national codes

COUNTRY	ISO 3166 2 LETTER CODE	COUNTRY	ISO 3166 2 LETTER CODE
Austria	AT	Liechtenstein	LI
Belgium	BE	Lithuania	LT
Bulgaria	BG	Luxembourg	LU
Croatia	HR	Malta	MT
Cyprus	CY	Netherlands	NL
Czech Republic	CZ	Norway	NO
Denmark	DK	Poland	PL
Estonia	EE	Portugal	PT
Finland	FI	Romania	RO
France	FR	Serbia	RS
Germany	DE	Slovakia	SK
Greece	GR	Slovenia	SI
Hungary	HU	Spain	ES
Iceland	IS	Switzerland	CH
Ireland	IE	Sweden	SE
Italy	IT	Turkey	TR
Latvia	LV	United Kingdom	GB

Safety Warnings

- Do not use this product near water, for example, in a wet basement or near a swimming pool.
- Do not expose your device to dampness, dust or corrosive liquids.
- Do not store things on the device.
- Do not install, use, or service this device during a thunderstorm. There is a remote risk of electric shock from lightning.
- Connect ONLY suitable accessories to the device.
- Do not open the device or unit. Opening or removing covers can expose you to dangerous high voltage points or other risks. ONLY qualified service personnel should service or disassemble this device. Please contact your vendor for further information.
- Make sure to connect the cables to the correct ports.
- Place connecting cables carefully so that no one will step on them or stumble over them.
- Always disconnect all cables from this device before servicing or disassembling.
- Do not remove the plug and connect it to a power outlet by itself; always attach the plug to the power adaptor first before connecting it to a power outlet.
- Do not allow anything to rest on the power adaptor or cord and do NOT place the product where anyone can walk on the power adaptor or cord.
- Please use the provided or designated connection cables/power cables/ adaptors. Connect it to the right supply voltage (for example, 110V AC in North America or 230V AC in Europe). If the power adaptor or cord is damaged, it might cause electrocution. Remove it from the device and the power source, repairing the power adapter or cord is prohibited. Contact your local vendor to order a new one.
- Do not use the device outside, and make sure all the connections are indoors. There is a remote risk of electric shock from lightning.
- CAUTION: Risk of explosion if battery is replaced by an incorrect type, dispose of used batteries according to the instruction. Dispose them at the applicable collection point for the recycling of electrical and electronic devices. For detailed information about recycling of this product, please contact your local city office, your household waste disposal service or the store where you purchased the product.
- Do not obstruct the device ventilation slots, as insufficient airflow may harm your device.

The following warning statements apply, where the disconnect device is not incorporated in the device or where the plug on the power supply cord is intended to serve as the disconnect device,

- For permanently connected devices, a readily accessible disconnect device shall be incorporated external to the device;
- For pluggable devices, the socket-outlet shall be installed near the device and shall be easily accessible.

Environment Statement**ErP (Energy-related Products)**

ZyXEL products put on the EU market in compliance with the requirement of the European Parliament and the Council published Directive 2009/125/EC establishing a framework for the setting of ecodesign requirements for energy-related products (recast), so called as "ErP Directive (Energy-related Products directive) as well as ecodesign requirement laid down in applicable implementing measures, power consumption has satisfied regulation requirements which are:

Network standby power consumption < 12W, and/or

Off mode power consumption < 0.5W, and/or

Standby mode power consumption < 0.5W.

Wireless setting, please refer to "Wireless" chapter for more detail.

European Union - Disposal and Recycling Information

The symbol below means that according to local regulations your product and/or its battery shall be disposed of separately from domestic waste. If this product is end of life, take it to a recycling station designated by local authorities. At the time of disposal, the separate collection of your product and/or its battery will help save natural resources and ensure that the environment is sustainable development.

Die folgende Symbol bedeutet, dass Ihr Produkt und/oder seine Batterie gemäß den örtlichen Bestimmungen getrennt vom Hausmüll entsorgt werden muss. Wenden Sie sich an eine Recyclingstation, wenn dieses Produkt das Ende seiner Lebensdauer erreicht hat. Zum Zeitpunkt der Entsorgung wird die getrennte Sammlung von Produkt und/oder seiner Batterie dazu beitragen, natürliche Ressourcen zu sparen und die Umwelt und die menschliche Gesundheit zu schützen.

El símbolo de abajo indica que según las regulaciones locales, su producto y/o su batería deberán depositarse como basura separada de la doméstica. Cuando este producto alcance el final de su vida útil, llévelo a un punto limpio. Cuando llegue el momento de desechar el producto, la recogida por separado éste y/o su batería ayudará a salvar los recursos naturales y a proteger la salud humana y medioambiental.

Le symbole ci-dessous signifie que selon les réglementations locales votre produit et/ou sa batterie doivent être éliminés séparément des ordures ménagères. Lorsque ce produit atteint sa fin de vie, amenez-le à un centre de recyclage. Au moment de la mise au rebut, la collecte séparée de votre produit et/ou de sa batterie aidera à économiser les ressources naturelles et protéger l'environnement et la santé humaine.

Il simbolo sotto significa che secondo i regolamenti locali il vostro prodotto e/o batteria deve essere smaltito separatamente dai rifiuti domestici. Quando questo prodotto raggiunge la fine della vita di servizio portarlo a una stazione di riciclaggio. Al momento dello smaltimento, la raccolta separata del vostro prodotto e/o della sua batteria aiuta a risparmiare risorse naturali e a proteggere l'ambiente e la salute umana.

Symbolen innebär att enligt lokal lagstiftning ska produkten och/eller dess batteri kastas separat från hushållsavfallet. När den här produkten når slutet av sin livslängd ska du ta den till en återvinningsstation. Vid tiden för kasseringen bidrar du till en bättre miljö och mänsklig hälsa genom att göra dig av med den på ett återvinningsställe.



Environmental Product Declaration

Български (Bulgarian)	Čeština (Czech)	Dansk (Danish)	Deutsch (German)
<p>Екологична продуктова декларация</p> <p>RoHS Директива 2011/65/EC WEEE Директива 2012/19/EC PPW Директива 94/62/EC REACH REGULATION (EC) № 1907/2006 ECP Директива 2009/125/EC</p> <p>Име/ титла : Richard Hsu / Quality Management Division Senior Manager Подпис : Дата (dd/mm/yyyy): 01/10/2014</p>  	<p>Environmentální prohlášení o produktu</p> <p>RoHS Směrnice 2011/65/EU WEEE Směrnice 2012/19/EU PPW Směrnice 94/62/EC REACH Nařízení (ES) č. 1907/2006 ECP Směrnice 2009/125/ES</p> <p>Jméno/ titul : Richard Hsu / Quality Management Division Senior Manager Podpis : Datum (dd/mm/yyyy): 01/10/2014</p>  	<p>Miljøvaredeklaration</p> <p>RoHS Direktiv 2011/65/EU WEEE Direktiv 2012/19/EC PPW Direktiv 94/62/EF REACH Forordning (EF) nr. 1907/2006 ECP Direktiv 2009/125/EF</p> <p>Navn/ titel : Richard Hsu / Quality Management Division Senior Manager Underskrift : Dato (dd/mm/åååå): 01/10/2014</p>  	<p>Produkt-Umweltdeklaration</p> <p>RoHS Richtlinie 2011/65/EU WEEE Richtlinie 2012/19/EU PPW Richtlinie 94/62/EG REACH VERORDNUNG (EG) Nr. 1907/2006 ECP Richtlinie 2009/125/EG</p> <p>Name/ titel : Richard Hsu / Quality Management Division Senior Manager Unterschrift : Datum (dd/mm/jj): 2014/10/01</p>  
<p>Tooete keskkonnadeklaratsiooni</p> <p>RoHS Direktiiv 2011/65/EU WEEE Direktiiv 2012/19/EC PPW Direktiiv 94/62/EÜ REACH MÄÄRÄYS (EY) nr. 1907/2006 ECP Direktiiv 2009/125/EÜ</p> <p>Nimi/ amet : Richard Hsu / Quality Management Division Senior Manager Allkiri : Kuupäev (pp/kk/aaaa): 01/10/2014</p>  	<p>Environmental product declaration</p> <p>RoHS Directive 2011/65/EU WEEE Directive 2012/19/EC PPW Directive 94/62/EC REACH Regulation (EC) No. 1907/2006 ECP Directive 2009/125/EC</p> <p>Name/ title : Richard Hsu / Quality Management Division Senior Manager Signature : Date (dd/mm/yyyy): 01/10/2014</p>  	<p>Declaraciones Ambientales de Producto</p> <p>RoHS Directiva 2011/65/UE WEEE Directiva 2012/19/UE PPW Directiva 94/62/CE REACH REGLAMENTO (CE) nº 1907/2006 ECP Directiva 2009/125/CE</p> <p>Nombre/ título : Richard Hsu / Quality Management Division Senior Manager Firma : Fecha (dd/mm/aaaa): 2014/10/01</p>  	<p>Profil environnemental de produit</p> <p>RoHS Directive 2011/65/UE WEEE Directive 2012/19/UE PPW Directive 94/62/CE REACH RÈGLEMENT (CE) n° 1907/2006 ECP Directive 2009/125/CE</p> <p>Nom/ titre : Richard Hsu / Quality Management Division Senior Manager Signature : Date (dd/mm/aaaa): 2014/10/01</p>  
<p>Deklaraciju o zbrinjavanju proizvoda</p> <p>RoHS Direktiva 2011/65/EU WEEE Direktiva 2012/19/UE PPW Direktiva 94/62/EZ REACH Uredba (EZ) br. 1907/2006 ECP Direktiva 2009/125/EZ</p> <p>Ime/ naslov : Richard Hsu / Quality Management Division Senior Manager Podpis : Datum (dd/mm/yyyy): 01/10/2014</p>  	<p>Dichiarazione ambientale di prodotto</p> <p>RoHS Direttiva 2011/65/UE WEEE Direttiva 2012/19/UE PPW Direttiva 94/62/CE REACH REGOLAMENTO (CE) n. 1907/2006 ECP Direttiva 2009/125/CE</p> <p>Nome/ titolo : Richard Hsu / Quality Management Division Senior Manager Firma : Data (dd/mm/aaaa): 2014/10/01</p>  	<p>Produkta vides ietekmējuma deklarācija</p> <p>RoHS Direktīva 2011/65/ES WEEE Direktīva 2012/19/ES PPW Direktīva 94/62/EK REACH Regula (EĶ) Nr. 1907/2006 ECP Direktīva 2009/125/EK</p> <p>Nosaukums/ tituls : Richard Hsu / Quality Management Division Senior Manager Paraksts : Datums (dd/mm/yyyy): 01/10/2014</p>  	<p>Apinkosaušingų gaminių deklaraciją</p> <p>RoHS Direktyva 2011/65/ES WEEE Direktyva 2012/19/ES PPW Direktyva 94/62/EB REACH REGLAMENTAS (EB) nr. 1907/2006 ECP Direktyva 2009/125/EB</p> <p>Vardas/ titulė : Richard Hsu / Quality Management Division Senior Manager Parašas : Data (dd/mm/aaaa): 01/10/2014</p>  
<p>Környezetvédelmi terméknyilatkozatot</p> <p>RoHS 2011/65/EU irányelve WEEE 2012/19/EU irányelve PPW 94/62/EK irányelve REACH 1907/2006/EK rendszabály ECP 2009/125/EK irányelve</p> <p>Név/ cím : Richard Hsu / Quality Management Division Senior Manager Aláírás : Dátum (dd/mm/yyyy): 2014/10/01</p>  	<p>Dikjarazzjoni Ambientali dwar il-Prodott</p> <p>RoHS Direttiva 2011/65/UE WEEE Direttiva 2012/19/UE PPW Direttiva 94/62/CE REACH REGOLAMENTO (CE) NR 1907/2006 ECP Direttiva 2009/125/CE</p> <p>Isim/ titolu : Richard Hsu / Quality Management Division Senior Manager Firma : Data (dd/mm/aaaa): 2014/10/01</p>  	<p>Miljøproductverklaring</p> <p>RoHS Richtlin 2011/65/UE WEEE Richtlin 2012/19/UE PPW Richtlin 94/62/EG REACH Verordning (EG) nr. 1907/2006 ECP Richtlin 2009/125/EG</p> <p>Navn/ titel : Richard Hsu / Quality Management Division Senior Manager Handskrevet : Dato (dd/mm/åååå): 01/10/2014</p>  	<p>Deklaracja środowiskowa produktu</p> <p>RoHS Dyrektywa 2011/65/UE WEEE Dyrektywa 2012/19/UE PPW Dyrektywa 94/62/WE REACH Rozporządzenie (WE) nr. 1907/2006 ECP Dyrektywa 2009/125/WE</p> <p>Nazwisko/ tytuł : Richard Hsu / Quality Management Division Senior Manager Podpis : Data (dd/mm/aaaa): 2014/10/01</p>  
<p>Declaração ambiental do produto</p> <p>RoHS Diretiva 2011/65/UE WEEE Diretiva 2012/19/UE PPW Diretiva 94/62/CE REACH Regulamento (CE) nº 1907/2006 ECP Diretiva 2009/125/CE</p> <p>Nome/ título : Richard Hsu / Quality Management Division Senior Manager Assinatura : Data (dd/mm/aaaa): 01/10/2014</p>  	<p>Declarație de mediu privind produsele</p> <p>RoHS Directiva 2011/65/UE WEEE Directiva 2012/19/UE PPW Directiva 94/62/CE REACH REGULAMENTUL (CE) NR. 1907/2006 ECP Directiva 2009/125/CE</p> <p>Numele/ titlu : Richard Hsu / Quality Management Division Senior Manager Semnătura : Data (dd/mm/aaaa): 01/10/2014</p>  	<p>Vyhľadzenie o environmentálnom výrobku</p> <p>RoHS Smernica 2011/65/EU WEEE Smernica 2012/19/EC PPW Smernica 94/62/ES REACH Nařízení (ES) č. 1907/2006 ECP Smernica 2009/125/ES</p> <p>Menor/ titul : Richard Hsu / Quality Management Division Senior Manager Podpis : Datum (dd/mm/yyyy): 01/10/2014</p>  	<p>Okoljsko deklaracija izdelka</p> <p>RoHS Direktiva 2011/65/UE WEEE Direktiva 2012/19/UE PPW Direktiva 94/62/ES REACH Uredba (ES) br. 1907/2006 ECP Direktiva 2009/125/ES</p> <p>Ime/ nadvis : Richard Hsu / Quality Management Division Senior Manager Podpis : Datum (dd/mm/yyyy): 01/10/2014</p>  
<p>Standardin perustava ympäristötuoteseloste</p> <p>RoHS Direktiiv 2011/65/EU WEEE Direktiiv 2012/19/EC PPW Direktiiv 94/62/EY REACH ASETUS (EY) N:o 1907/2006 ECP Direktiiv 2009/125/EY</p> <p>Nimi/ titteli : Richard Hsu / Quality Management Division Senior Manager Alaenkirja : Päivämäärä (pp/kk/vvvv): 01/10/2014</p>  	<p>Miljöproduktdeklaration</p> <p>RoHS Direktiv 2011/65/EU WEEE Direktiv 2012/19/EC PPW Direktiv 94/62/EY REACH Förordning (EG) nr 1907/2006 ECP Direktiv 2009/125/EG</p> <p>Navn/ titel : Richard Hsu / Quality Management Division Senior Manager Namnteckning : Datum (dd/mm/åååå): 01/10/2014</p>  	<p>Περιβαλλοντική δήλωση προϊόντος</p> <p>RoHS Οδηγία 2011/65/ΕΕ WEEE Οδηγία 2012/19/ΕΕ PPW Οδηγία 94/62/ΕΚ REACH Κανονισμός (ΕΚ) αριθ. 1907/2006 ECP Οδηγία 2009/125/ΕΚ</p> <p>Όνομα/ τίτλος : Richard Hsu / Quality Management Division Senior Manager Υπογραφή : Ημερομηνία (gg/mm/aaaa): 01/10/2014</p>  	<p>Miljødeklarasjon</p> <p>RoHS Direktiv 2011/65/UE WEEE Direktiv 2012/19/UE PPW Direktiv 94/62/EF REACH Forordning (EF) nr. 1907/2006 ECP Direktiv 2009/125/EF</p> <p>Navn/ tittel : Richard Hsu / Quality Management Division Senior Manager Signatur : Dato (dd/mm/åååå): 01/10/2014</p>  

台灣



以下訊息僅適用於產品具有無線功能且銷售至台灣地區

第十二條 經型式認證合格之低功率射頻電機，非經許可，公司、商號或使用者均不得擅自變更頻率、加大功率或變更原設計之特性及功能。

第十四條 低功率射頻電機之使用不得影響飛航安全及干擾合法通信；經發現有干擾現象時，應立即停用，並改善至無干擾時方得繼續使用。前項合法通信，指依電信法規定作業之無線電通信。低功率射頻電機須忍受合法通信或工業、科學及醫療用電波輻射性電機設備之干擾。

用 20cm 計算 MPE 能符合 1 mW/cm²

電磁波曝露量 MPE 標準值 1mW/cm²，送測產品實測值為：0.199 mW/cm²

無線資訊傳輸設備須忍受合法通信之干擾且不得干擾合法通信；如造成干擾，應立即停用，俟無干擾之虞，始得繼續使用。

無線資訊傳輸設備的製造廠商應確保頻率穩定性，如依製造廠商使用手冊上所述正常操作，發射的信號應維持於操作頻帶中

以下訊息僅適用於產品操作於 5.25-5.35 赫赫頻帶內並銷售至台灣地區

- 在 5.25-5.35 赫赫頻帶內操作之無線資訊傳輸設備，限於室內使用。

以下訊息僅適用於產品屬於專業安裝並銷售至台灣地區

- 本器材須經專業工程人員安裝及設定，始得 設置使用，且不得直接販售給一般消費者

安全警告

為了您的安全，請先閱讀以下警告及指示：

- 請勿將此產品接近水、火焰或放置在高溫的環境。
- 避免設備接觸任何液體 - 切勿讓設備接觸水、雨水、高濕度、污水腐蝕性的液體或其他水份。
- 灰塵及污物 - 切勿接觸灰塵、污物、沙土、食物或其他不合適的材料。
- 雷雨天氣時，不要安裝，使用或維修此設備。有遭受電擊的風險。
- 切勿重摔或撞擊設備，並勿使用不正確的電源變壓器。
- 若接上不正確的電源變壓器會有爆炸的風險。
- 請勿隨意更換產品內的電池。
- 如果更換不正確之電池型式，會有爆炸的風險，請依製造商說明書處理使用過之電池。
- 請將廢電池丟棄在適當的電器或電子設備回收處。
- 請勿將設備解體。
- 請勿阻礙設備的散熱孔，空氣對流不足將會造成設備損害。
- 請插在正確的電壓供給插座（如：北美 / 台灣電壓 110V AC，歐洲是 230V AC）。
- 假若電源變壓器或電源變壓器的纜線損壞，請從插座拔除，若您還繼續插電使用，會有觸電死亡的風險。
- 請勿試圖修理電源變壓器或電源變壓器的纜線，若有毀損，請直接聯絡您購買的店家，購買一個新的電源變壓器。
- 請勿將此設備安裝於室外，此設備僅適合放置於室內。
- 請勿隨一般垃圾丟棄。
- 請參閱產品背貼上的設備額定功率。
- 請參考產品型錄或是彩盒上的作業溫度。
- 產品沒有斷電裝置或者採用電源線的插頭視為斷電裝置的一部分，以下警語將適用：
 - 對永久連接之設備，在設備外部須安裝可觸及之斷電裝置；
 - 對插接式之設備，插座必須接近安裝之地點而且是易於觸及的。

Viewing Certifications

Go to <http://www.zyxel.com> to view this product's documentation and certifications.

ZyXEL Limited Warranty

ZyXEL warrants to the original end user (purchaser) that this product is free from any defects in material or workmanship for a specific period (the Warranty Period) from the date of purchase. The Warranty Period varies by region. Check with your vendor and/or the authorized ZyXEL local distributor for details about the Warranty Period of this product. During the warranty period, and upon proof of purchase, should the product have indications of failure due to faulty workmanship and/or materials, ZyXEL will, at its discretion, repair or replace the defective products or components without charge for either parts or labor, and to whatever extent it shall deem necessary to restore the product or components to proper operating condition. Any replacement will consist of a new or re-manufactured functionally equivalent product of equal or higher value, and will be solely at the discretion of ZyXEL. This warranty shall not apply if the product has been modified, misused, tampered with, damaged by an act of God, or subjected to abnormal working conditions.

Note

Repair or replacement, as provided under this warranty, is the exclusive remedy of the purchaser. This warranty is in lieu of all other warranties, express or implied, including any implied warranty of merchantability or fitness for a particular use or purpose. ZyXEL shall in no event be held liable for indirect or consequential damages of any kind to the purchaser.

To obtain the services of this warranty, contact your vendor. You may also refer to the warranty policy for the region in which you bought the device at http://www.zyxel.com/web/support_warranty_info.php.

Registration

Register your product online to receive e-mail notices of firmware upgrades and information at www.zyxel.com for global products, or at www.us.zyxel.com for North American products.

Open Source Licenses

This product contains in part some free software distributed under GPL license terms and/or GPL like licenses. Open source licenses are provided with the firmware package. You can download the latest firmware at www.zyxel.com. To obtain the source code covered under those Licenses, please contact support@zyxel.com.tw to get it.

Customer Support

In the event of problems that cannot be solved by using this manual, you should contact your vendor. If you cannot contact your vendor, then contact a ZyXEL office for the region in which you bought the device.

See <http://www.zyxel.com/homepage.shtml> and also

http://www.zyxel.com/about_zyxel/zyxel_worldwide.shtml for the latest information.

Please have the following information ready when you contact an office.

Required Information

- Product model and serial number.
- Warranty Information.
- Date that you received your device.
- Brief description of the problem and the steps you took to solve it.

Corporate Headquarters (Worldwide)

Taiwan

- ZyXEL Communications Corporation
- <http://www.zyxel.com>

Asia

China

- ZyXEL Communications (Shanghai) Corp.
- ZyXEL Communications (Beijing) Corp.
- ZyXEL Communications (Tianjin) Corp.
- <http://www.zyxel.cn>

India

- ZyXEL Technology India Pvt Ltd
- <http://www.zyxel.in>

Kazakhstan

- ZyXEL Kazakhstan

- <http://www.zyxel.kz>

Korea

- ZyXEL Korea Corp.
- <http://www.zyxel.kr>

Malaysia

- ZyXEL Malaysia Sdn Bhd.
- <http://www.zyxel.com.my>

Pakistan

- ZyXEL Pakistan (Pvt.) Ltd.
- <http://www.zyxel.com.pk>

Philippines

- ZyXEL Philippines
- <http://www.zyxel.com.ph>

Singapore

- ZyXEL Singapore Pte Ltd.
- <http://www.zyxel.com.sg>

Taiwan

- ZyXEL Communications Corporation
- <http://www.zyxel.com/tw/zh/>

Thailand

- ZyXEL Thailand Co., Ltd
- <http://www.zyxel.co.th>

Vietnam

- ZyXEL Communications Corporation-Vietnam Office
- <http://www.zyxel.com/vn/vi>

Europe

Austria

- ZyXEL Deutschland GmbH
- <http://www.zyxel.de>

Belarus

- ZyXEL BY
- <http://www.zyxel.by>

Belgium

- ZyXEL Communications B.V.
- <http://www.zyxel.com/be/nl/>
- <http://www.zyxel.com/be/fr/>

Bulgaria

- ZyXEL България
- <http://www.zyxel.com/bg/bg/>

Czech Republic

- ZyXEL Communications Czech s.r.o
- <http://www.zyxel.cz>

Denmark

- ZyXEL Communications A/S
- <http://www.zyxel.dk>

Estonia

- ZyXEL Estonia
- <http://www.zyxel.com/ee/et/>

Finland

- ZyXEL Communications
- <http://www.zyxel.fi>

France

- ZyXEL France
- <http://www.zyxel.fr>

Germany

- ZyXEL Deutschland GmbH
- <http://www.zyxel.de>

Hungary

- ZyXEL Hungary & SEE
- <http://www.zyxel.hu>

Italy

- ZyXEL Communications Italy
- <http://www.zyxel.it/>

Latvia

- ZyXEL Latvia
- <http://www.zyxel.com/lv/lv/homepage.shtml>

Lithuania

- ZyXEL Lithuania
- <http://www.zyxel.com/lt/lt/homepage.shtml>

Netherlands

- ZyXEL Benelux
- <http://www.zyxel.nl>

Norway

- ZyXEL Communications
- <http://www.zyxel.no>

Poland

- ZyXEL Communications Poland
- <http://www.zyxel.pl>

Romania

- ZyXEL Romania
- <http://www.zyxel.com/ro/ro>

Russia

- ZyXEL Russia
- <http://www.zyxel.ru>

Slovakia

- ZyXEL Communications Czech s.r.o. organizacna zlozka
- <http://www.zyxel.sk>

Spain

- ZyXEL Communications ES Ltd
- <http://www.zyxel.es>

Sweden

- ZyXEL Communications

- <http://www.zyxel.se>

Switzerland

- Studerus AG
- <http://www.zyxel.ch/>

Turkey

- ZyXEL Turkey A.S.
- <http://www.zyxel.com.tr>

UK

- ZyXEL Communications UK Ltd.
- <http://www.zyxel.co.uk>

Ukraine

- ZyXEL Ukraine
- <http://www.ua.zyxel.com>

Latin America

Argentina

- ZyXEL Communication Corporation
- <http://www.zyxel.com/ec/es/>

Brazil

- ZyXEL Communications Brasil Ltda.
- <https://www.zyxel.com/br/pt/>

Ecuador

- ZyXEL Communication Corporation
- <http://www.zyxel.com/ec/es/>

Middle East

Israel

- ZyXEL Communication Corporation
- <http://il.zyxel.com/homepage.shtml>

Middle East

- ZyXEL Communication Corporation

- <http://www.zyxel.com/me/en/>

North America

USA

- ZyXEL Communications, Inc. - North America Headquarters
- <http://www.zyxel.com/us/en/>

Oceania

Australia

- ZyXEL Communications Corporation
- <http://www.zyxel.com/au/en/>

Africa

South Africa

- Nology (Pty) Ltd.
- <http://www.zyxel.co.za>

A

Address Assignment [102](#)
Advanced Encryption Standard
 See AES.
AES [220](#)
alternative subnet mask notation [176](#)
antenna
 directional [224](#)
 gain [224](#)
 omni-directional [224](#)
AP [12](#)
AP (access point) [214](#)
AP Mode
 menu [59, 67](#)
 status screen [57](#)
AP+Bridge [12](#)

B

Bandwidth management
 overview [136](#)
 priority [138](#)
Basic Service Set, See BSS [212](#)
Bridge/Repeater [12](#)
bridged APs, security [83](#)
BSS [212](#)

C

CA [218](#)
Certificate Authority
 See CA.
certifications [233](#)
 viewing [236](#)
Channel [51, 58, 59, 66](#)
channel [81, 214](#)
 interference [214](#)

CIFS [153](#)
Common Internet File System, see CIFS
Configuration
 restore [165](#)
contact information [239](#)
content filtering [134](#)
 by keyword (in URL) [134](#)
 by web feature [134](#)
copyright [229](#)
CPU usage [52, 59, 66](#)
CTS (Clear to Send) [215](#)
customer support [239](#)

D

Daylight saving [163](#)
DDNS [123](#)
 see also Dynamic DNS
 service providers [123](#)
DHCP [32, 114](#)
 DHCP server
 see also Dynamic Host Configuration Protocol
DHCP server [112, 114](#)
DHCP table [32](#)
 DHCP client information
 DHCP status
DHCP Unique IDentifier [98](#)
DHCPv6
 DHCP Unique IDentifier [98](#)
Digital Living Network Alliance [152](#)
disclaimer [229](#)
DLNA [151, 152](#)
 indexing [155](#)
 overview [151](#)
 rescan [155](#)
DLNA-compliant client [152](#)
DNS [116](#)
DNS Server [102](#)
DNS server [116](#)

documentation
 related [2](#)

Domain Name System [116](#)

Domain Name System. See DNS.

DUID [98](#)

duplex setting [52, 59](#)

Dynamic DNS [123](#)

Dynamic Host Configuration Protocol [114](#)

dynamic WEP key exchange [219](#)

DynDNS [123](#)

DynDNS see also DDNS [123](#)

E

EAP Authentication [218](#)

encryption [82, 220](#)
 key [82](#)
 WPA compatible [82](#)

ESS [213](#)

ESSID [171](#)

Extended Service Set, See ESS [213](#)

F

file sharing [152](#)
 access right [155, 156](#)
 example [156](#)
 FTP [155](#)
 overview [152](#)
 Samba [154](#)
 user account [154, 156](#)
 Windows Explorer [154](#)
 work group [154](#)

Firewall
 ICMP packets [129, 130](#)

Firmware upload [163](#)
 file extension
 using HTTP

firmware version [51, 58](#)

fragmentation threshold [215](#)

G

General wireless LAN screen [83, 85](#)

Guide
 Quick Start [2](#)

H

hidden node [214](#)

I

IANA [181](#)

IBSS [212](#)

IGMP [103](#)
 see also Internet Group Multicast Protocol
 version

IGMP version [103](#)

Independent Basic Service Set
 See IBSS [212](#)

initialization vector (IV) [220](#)

interfaces [96](#)

Internet Assigned Numbers Authority
 See IANA [181](#)

Internet Group Multicast Protocol [103](#)

Internet Protocol version 6, see IPv6

IP Address [113, 118, 119](#)

IP alias [112](#)

IP Pool [114](#)

IPv6 [96](#)
 link-local address [97](#)
 prefix [96](#)
 prefix delegation [97](#)
 prefix length [96](#)
 stateless autoconfiguration [97](#)

L

LAN [111](#)
 IP pool setup [112](#)

LAN overview [111](#)

LAN setup [111](#)
LAN TCP/IP [112](#)
Language [166](#)
Link type [52](#), [59](#), [66](#)
Local Area Network [111](#)

M

MAC [89](#)
MAC address [81](#), [102](#)
 cloning [102](#)
MAC address filter [81](#)
MAC address filtering [89](#)
MAC filter [89](#)
managing the device
 good habits [13](#)
 using the web configurator. See web configurator.
 using the wireless switch.
 using the WPS. See WPS.
MBSSID [12](#)
Media access control [89](#)
media client [151](#)
media file [151](#)
media server [151](#)
 overview [151](#)
media file play [151](#)
Memory usage [52](#), [59](#), [66](#)
Message Integrity Check (MIC) [220](#)
mode [12](#)
Multicast [103](#)
 IGMP [103](#)

N

NAT [117](#), [118](#), [181](#)
 how it works [117](#)
 overview [117](#)
 see also Network Address Translation
NAT Traversal [144](#)
Navigation Panel [52](#), [59](#), [67](#)
navigation panel [52](#), [59](#), [67](#)
Network Address Translation [117](#), [118](#)

O

operating mode [12](#)
other documentation [2](#)

P

Pairwise Master Key (PMK) [220](#), [222](#)
Point-to-Point Protocol over Ethernet [105](#)
Point-to-Point Tunneling Protocol [107](#)
Port forwarding [119](#)
 default server [118](#)
 local server [119](#)
port speed [52](#), [59](#), [67](#)
PPPoE [105](#)
 dial-up connection
PPTP [107](#)
preamble mode [216](#)
prefix delegation [97](#)
PSK [220](#)

Q

Quality of Service (QoS) [91](#)
Quick Start Guide [2](#)

R

RADIUS [217](#)
 message types [217](#)
 messages [217](#)
 shared secret key [218](#)
related documentation [2](#)
Remote management
 and NAT [142](#)
 limitations [142](#)
 system timeout [143](#)
Reset button [30](#)
Reset the device [30](#)
Restore configuration [165](#)
Roaming [90](#)

RTS (Request To Send) [215](#)
 threshold [214, 215](#)
 RTS/CTS Threshold [81, 90](#)

S

Samba [153](#)
 Scheduling [93](#)
 Server Message Block, see SMB
 Service and port numbers [130, 133, 141](#)
 Service Set [46, 84](#)
 Service Set IDentification [46, 84](#)
 Service Set IDentity. See SSID.
 SMB [153](#)
 SSID [46, 51, 58, 59, 66, 81, 84](#)
 Static DHCP [115](#)
 Static Route [125](#)
 Status [49](#)
 subnet [174](#)
 Subnet Mask [113](#)
 subnet mask [175](#)
 subnetting [177](#)
 Summary
 DHCP table [32](#)
 Packet statistics [33](#)
 Wireless station status [34, 35](#)
 System General Setup [160](#)
 System restart [166](#)

T

TCP/IP configuration [114](#)
 Temporal Key Integrity Protocol (TKIP) [220](#)
 Time setting [162](#)
 trigger port [120](#)
 Trigger port forwarding [120](#)
 example [121](#)
 process [121](#)

U

Universal [63](#)
 Universal Plug and Play [144](#)
 Application [144](#)
 Security issues [145](#)
 Universal Repeater [63, 67](#)
 UPnP [144](#)
 URL Keyword Blocking [135](#)
 USB media sharing [151](#)
 User Name [124](#)

V

VPN [107](#)

W

WAN (Wide Area Network) [101](#)
 WAN advanced [109](#)
 WAN MAC address [102](#)
 warranty [236](#)
 note [236](#)
 Web Configurator
 how to access [26](#)
 Overview [26](#)
 web configurator [12](#)
 WEP Encryption [68, 70, 87, 88](#)
 WEP encryption [86](#)
 WEP key [86](#)
 Wi-Fi Protected Access [220](#)
 windows media player [151](#)
 Wireless association list [34, 35](#)
 wireless channel [171](#)
 wireless client WPA supplicants [221](#)
 wireless LAN [171](#)
 wireless LAN scheduling [93](#)
 Wireless network
 basic guidelines [80](#)
 channel [81](#)
 encryption [82](#)
 example [80](#)

- MAC address filter [81](#)
 - overview [80](#)
 - security [81](#)
 - SSID [81](#)
- Wireless security [81](#)
 - overview [81](#)
 - type [81](#)
- wireless security [171, 216](#)
- wireless switch [12](#)
- Wireless tutorial [72](#)
 - WPS [72](#)
- Wizard setup [17](#)
- WLAN
 - interference [214](#)
 - security parameters [223](#)
- WLAN 2.4G [34](#)
- WLAN 5G [35](#)
- work group [153](#)
 - name [153](#)
 - Windows [153](#)
- WPA [220](#)
 - key caching [221](#)
 - pre-authentication [221](#)
 - user authentication [221](#)
 - vs WPA-PSK [220](#)
 - wireless client supplicant [221](#)
 - with RADIUS application example [221](#)
- WPA compatible [82](#)
- WPA2 [220](#)
 - user authentication [221](#)
 - vs WPA2-PSK [220](#)
 - wireless client supplicant [221](#)
 - with RADIUS application example [221](#)
- WPA2-Pre-Shared Key [220](#)
- WPA2-PSK [220](#)
 - application example [222](#)
- WPA-PSK [220](#)
 - application example [222](#)
- WPS [12](#)