



VMG1312-B Series

Wireless N VDSL2 4-port Gateway with USB

Version 1.00
Edition 3, 10/2015

User's Guide

Default Login Details

LAN IP Address	http://192.168.1.1
User Name	admin, zyuser
Password	1234, 1234

IMPORTANT!

READ CAREFULLY BEFORE USE.

KEEP THIS GUIDE FOR FUTURE REFERENCE.

Screenshots and graphics in this book may differ slightly from your product due to differences in your product firmware or your computer operating system. Every effort has been made to ensure that the information in this manual is accurate.

Related Documentation

- Quick Start Guide

The Quick Start Guide shows how to connect the Device and get up and running right away.

- More Information

Go to support.zyxel.com to find other information on the Device.



Contents Overview

User's Guide	15
Introducing the Device	17
The Web Configurator	23
Quick Start	31
Tutorials	33
Technical Reference	60
Network Map and Status Screens	62
Broadband	66
Wireless	94
Home Networking	125
Routing	141
Quality of Service (QoS)	148
Network Address Translation (NAT)	165
Dynamic DNS Setup	182
IGMP/MLD	186
Vlan Group	189
Interface Group	191
USB Service	196
Power Management	203
Firewall	207
MAC Filter	216
Parental Control	218
Scheduler Rule	223
Certificates	225
Log	232
Traffic Status	235
ARP Table	239
Routing Table	241
IGMP/MLD Status	243
xDSL Statistics	245
3G Statistics	249
User Account	251
Remote Management	253
TR-069 Client	255
TR-064	257
SNMP	258
Time Settings	260

E-mail Notification	262
Log Setting	264
Firmware Upgrade	267
Configuration	270
Diagnostic	273
Troubleshooting	278
Appendices	285

Table of Contents

Contents Overview	3
Table of Contents	5
Part I: User's Guide	15
Chapter 1	
Introducing the Device	17
1.1 Overview	17
1.2 Ways to Manage the Device	17
1.3 Good Habits for Managing the Device	17
1.4 Applications for the Device	18
1.4.1 Internet Access	18
1.4.2 Device's USB Support	18
1.5 LEDs (Lights)	20
1.6 The RESET Button	21
1.7 Wireless Access	21
1.7.1 Using the WLAN/WPS Button	22
Chapter 2	
The Web Configurator	23
2.1 Overview	23
2.1.1 Accessing the Web Configurator	23
2.2 Web Configurator Layout	25
2.2.1 Title Bar	25
2.2.2 Main Window	26
2.2.3 Navigation Panel	26
Chapter 3	
Quick Start	31
3.1 Overview	31
3.2 Quick Start Setup	31
Chapter 4	
Tutorials	33
4.1 Overview	33
4.2 Setting Up an ADSL PPPoE Connection	33
4.3 Setting Up a Secure Wireless Network	36

4.3.1 Configuring the Wireless Network Settings	36
4.3.2 Using WPS	37
4.3.3 Without WPS	41
4.4 Setting Up Multiple Wireless Groups	42
4.5 Configuring Static Route for Routing to Another Network	45
4.6 Configuring QoS Queue and Class Setup	47
4.7 Access the Device Using DDNS	51
4.7.1 Registering a DDNS Account on www.dyndns.org	51
4.7.2 Configuring DDNS on Your Device	52
4.7.3 Testing the DDNS Setting	52
4.8 Configuring the MAC Address Filter	52
4.9 Access Your Shared Files From a Computer	53
4.10 Using the Print Server Feature	54

Part II: Technical Reference..... 60

**Chapter 5
Network Map and Status Screens 62**

5.1 Overview	62
5.2 The Network Map Screen	62
5.3 The Status Screen	63

**Chapter 6
Broadband..... 66**

6.1 Overview	66
6.1.1 What You Can Do in this Chapter	66
6.1.2 What You Need to Know	67
6.1.3 Before You Begin	70
6.2 The Broadband Screen	70
6.2.1 Add/Edit Internet Connection	72
6.3 The 3G Backup Screen	79
6.4 The Advanced Screen	83
6.5 The 802.1x Screen	86
6.5.1 Modify 802.1X Settings	87
6.6 The Ethernet WAN Screen	87
6.7 Technical Reference	88

**Chapter 7
Wireless..... 94**

7.1 Overview	94
7.1.1 What You Can Do in this Chapter	94

7.1.2 What You Need to Know	94
7.2 The General Screen	95
7.2.1 No Security	97
7.2.2 Basic (WEP Encryption)	97
7.2.3 More Secure (WPA(2)-PSK)	98
7.3 The Guest / More AP Screen	99
7.3.1 Edit Guest / More AP	100
7.4 MAC Authentication	102
7.5 The WPS Screen	103
7.6 The WMM Screen	105
7.7 The WDS Screen	106
7.7.1 WDS Scan	108
7.8 The Others Screen	108
7.9 The Channel Status Screen	110
7.10 Technical Reference	111
7.10.1 Wireless Network Overview	111
7.10.2 Additional Wireless Terms	113
7.10.3 Wireless Security Overview	113
7.10.4 Signal Problems	115
7.10.5 BSS	116
7.10.6 MBSSID	116
7.10.7 Preamble Type	117
7.10.8 Wireless Distribution System (WDS)	117
7.10.9 WiFi Protected Setup (WPS)	117

Chapter 8

Home Networking 125

8.1 Overview	125
8.1.1 What You Can Do in this Chapter	125
8.1.2 What You Need To Know	126
8.1.3 Before You Begin	127
8.2 The LAN Setup Screen	127
8.3 The Static DHCP Screen	131
8.4 The UPnP Screen	132
8.4.1 Turning On UPnP in Windows 7 Example	133
8.5 The Additional Subnet Screen	135
8.6 The STB Vendor ID Screen	136
8.6.1 The Add/Edit STB Vendor ID Screen	136
8.7 The TFTP Server Name Screen	137
8.8 Technical Reference	138
8.8.1 LANs, WANs and the Device	138
8.8.2 DHCP Setup	138
8.8.3 DNS Server Addresses	138

8.8.4 LAN TCP/IP	139
Chapter 9	
Routing	141
9.1 Overview	141
9.2 The Routing Screen	141
9.2.1 Add/Edit Static Route	142
9.3 The DNS Route Screen	143
9.3.1 The DNS Route Add Screen	144
9.4 The Policy Forwarding Screen	144
9.4.1 Add/Edit Policy Forwarding	146
9.5 RIP	146
9.5.1 The RIP Screen	147
Chapter 10	
Quality of Service (QoS).....	148
10.1 Overview	148
10.1.1 What You Can Do in this Chapter	148
10.2 What You Need to Know	148
10.3 The Quality of Service General Screen	150
10.4 The Queue Setup Screen	151
10.4.1 Adding a QoS Queue	152
10.5 The Class Setup Screen	153
10.5.1 Add/Edit QoS Class	154
10.6 The QoS Policer Setup Screen	158
10.6.1 Add/Edit a QoS Policer	159
10.7 Technical Reference	160
Chapter 11	
Network Address Translation (NAT).....	165
11.1 Overview	165
11.1.1 What You Can Do in this Chapter	165
11.1.2 What You Need To Know	165
11.2 The Port Forwarding Screen	166
11.2.1 Add/Edit Port Forwarding	168
11.3 The Applications Screen	169
11.3.1 Add New Application	170
11.4 The Port Triggering Screen	171
11.4.1 Add/Edit Port Triggering Rule	172
11.5 The DMZ Screen	173
11.6 The ALG Screen	174
11.7 The Address Mapping Screen	175
11.7.1 Add/Edit Address Mapping Rule	176

11.8 The Sessions Screen	177
11.9 Technical Reference	177
11.9.1 NAT Definitions	178
11.9.2 What NAT Does	178
11.9.3 How NAT Works	179
11.9.4 NAT Application	179
Chapter 12	
Dynamic DNS Setup	182
12.1 Overview	182
12.1.1 What You Can Do in this Chapter	182
12.1.2 What You Need To Know	182
12.2 The DNS Entry Screen	183
12.2.1 Add/Edit DNS Entry	183
12.3 The Dynamic DNS Screen	184
Chapter 13	
IGMP/MLD	186
13.1 Overview	186
13.1.1 What You Need To Know	186
13.2 The IGMP/MLD Screen	186
Chapter 14	
Vlan Group	189
14.1 Overview	189
14.1.1 What You Can Do in this Chapter	189
14.2 The Vlan Group Screen	189
14.2.1 Add/Edit a VLAN Group	190
Chapter 15	
Interface Group	191
15.1 Overview	191
15.1.1 What You Can Do in this Chapter	191
15.2 The Interface Group Screen	191
15.2.1 Interface Group Configuration	192
15.2.2 Interface Grouping Criteria	194
Chapter 16	
USB Service	196
16.1 Overview	196
16.1.1 What You Can Do in this Chapter	196
16.1.2 What You Need To Know	196
16.1.3 Before You Begin	198

16.2 The File Sharing Screen	198
16.2.1 The Add New User Screen	199
16.3 The Media Server Screen	200
16.4 Print Server	201
16.4.1 Before You Begin	201
16.4.2 The Print Server Screen	202
Chapter 17	
Power Management	203
17.1 Overview	203
17.1.1 What You Can Do in this Chapter	203
17.1.2 What You Need To Know	203
17.2 The Power Management Screen	203
17.3 The Auto Switch Off Screen	204
17.3.1 The Auto Switch Off Add or Modify Screen	205
17.3.2 The Add/Edit Rule Screen	206
Chapter 18	
Firewall	207
18.1 Overview	207
18.1.1 What You Can Do in this Chapter	207
18.1.2 What You Need to Know	208
18.2 The Firewall Screen	208
18.3 The Protocol Screen	209
18.3.1 Add/Edit a Service	210
18.4 The Access Control Screen	212
18.4.1 Add/Edit an ACL Rule	212
18.5 The DoS Screen	214
Chapter 19	
MAC Filter	216
19.1 Overview	216
19.2 The MAC Filter Screen	216
Chapter 20	
Parental Control	218
20.1 Overview	218
20.2 The Parental Control Screen	218
20.2.1 Add/Edit a Parental Control Profile	219
Chapter 21	
Scheduler Rule	223
21.1 Overview	223

21.2 The Scheduler Rule Screen	223
21.2.1 Add/Edit a Schedule	224
Chapter 22	
Certificates	225
22.1 Overview	225
22.1.1 What You Can Do in this Chapter	225
22.2 What You Need to Know	225
22.3 The Local Certificates Screen	225
22.3.1 Create Certificate Request	226
22.3.2 Load Signed Certificate	228
22.4 The Trusted CA Screen	228
22.4.1 View Trusted CA Certificate	229
22.4.2 Import Trusted CA Certificate	230
Chapter 23	
Log	232
23.1 Overview	232
23.1.1 What You Can Do in this Chapter	232
23.1.2 What You Need To Know	232
23.2 The System Log Screen	233
23.3 The Security Log Screen	234
Chapter 24	
Traffic Status	235
24.1 Overview	235
24.1.1 What You Can Do in this Chapter	235
24.2 The WAN Status Screen	235
24.3 The LAN Status Screen	236
24.4 The NAT Status Screen	237
Chapter 25	
ARP Table	239
25.1 Overview	239
25.1.1 How ARP Works	239
25.2 ARP Table Screen	240
Chapter 26	
Routing Table	241
26.1 Overview	241
26.2 The Routing Table Screen	241
Chapter 27	
IGMP/MLD Status	243

27.1 Overview	243
27.2 The IGMP/MLD Group Status Screen	243
Chapter 28	
xDSL Statistics.....	245
28.1 The xDSL Statistics Screen	245
Chapter 29	
3G Statistics	249
29.1 Overview	249
29.2 The 3G Statistics Screen	249
Chapter 30	
User Account	251
30.1 Overview	251
30.2 The User Account Screen	251
30.2.1 The User Account Add/Edit Screen	252
Chapter 31	
Remote Management.....	253
31.1 Overview	253
31.2 The Remote MGMT Screen	253
Chapter 32	
TR-069 Client.....	255
32.1 Overview	255
32.2 The TR-069 Client Screen	255
Chapter 33	
TR-064.....	257
33.1 Overview	257
33.2 The TR-064 Screen	257
Chapter 34	
SNMP	258
34.1 Overview	258
34.2 The SNMP Screen	258
Chapter 35	
Time Settings	260
35.1 Overview	260
35.2 The Time Screen	260

Chapter 36	
E-mail Notification	262
36.1 Overview	262
36.2 The Email Notification Screen	262
36.2.1 Email Notification Edit	263
Chapter 37	
Log Setting	264
37.1 Overview	264
37.2 The Log Settings Screen	264
37.2.1 Example E-mail Log	265
Chapter 38	
Firmware Upgrade	267
38.1 Overview	267
38.2 The Firmware Screen	267
Chapter 39	
Configuration	270
39.1 Overview	270
39.2 The Configuration Screen	270
39.3 The Reboot Screen	272
Chapter 40	
Diagnostic	273
40.1 Overview	273
40.1.1 What You Can Do in this Chapter	273
40.2 What You Need to Know	273
40.3 Ping & TraceRoute & Nslookup	274
40.4 802.1ag	274
40.5 OAM Ping	275
Chapter 41	
Troubleshooting.....	278
41.1 Power, Hardware Connections, and LEDs	278
41.2 Device Access and Login	279
41.3 Internet Access	281
41.4 Wireless Internet Access	282
41.5 USB Device Connection	283
41.6 UPnP	283

Part III: Appendices	285
Appendix A Customer Support	287
Appendix B Wireless LANs	293
Appendix C IPv6	306
Appendix D Services	314
Appendix E Legal Information.....	318
Index	325

PART I

User's Guide

Introducing the Device

1.1 Overview

The VMG1312-B Series is a wireless VDSL router and Gigabit Ethernet gateway. It has a DSL port and a Gigabit Ethernet port for super-fast Internet access. The Device supports both Packet Transfer Mode (PTM) and Asynchronous Transfer Mode (ATM). It is backward compatible with ADSL, ADSL2 and ADSL2+ in case VDSL is not available.

Only use firmware for your Device's specific model. Refer to the label on the bottom of your Device.

The Device has two USB ports for sharing files via a USB storage device, sharing a USB printer, or connecting a 3G dongle for a WAN backup connection.

- The VMG1312-B10A works over the analog telephone system, POTS (Plain Old Telephone Service).
- The VMG1312-B30A works over ISDN (Integrated Services Digital Network) or T-ISDN (UR-2).

1.2 Ways to Manage the Device

Use any of the following methods to manage the Device.

- Web Configurator. This is recommended for everyday management of the Device using a (supported) web browser.
- TR-069. This is an auto-configuration server used to remotely configure your device.

1.3 Good Habits for Managing the Device

Do the following things regularly to make the Device more secure and to manage the Device more effectively.

- Change the password. Use a password that's not easy to guess and that consists of different types of characters, such as numbers and letters.
- Write down the password and put it in a safe place.
- Back up the configuration (and make sure you know how to restore it). Restoring an earlier working configuration may be useful if the device becomes unstable or even crashes. If you forget your password, you will have to reset the Device to its factory default settings. If you backed up an earlier configuration file, you would not have to totally re-configure the Device. You could simply restore your last configuration.

1.4 Applications for the Device

Here are some example uses for which the Device is well suited.

1.4.1 Internet Access

Your Device provides shared Internet access by connecting the DSL port to the **DSL** or **MODEM** jack on a splitter or your telephone jack. You can have multiple WAN services over one ADSL or VDSL. The Device cannot work in ADSL and VDSL mode at the same time.

Note: The ADSL and VDSL lines share the same WAN (layer-2) interfaces that you configure in the Device. Refer to [Section 6.2 on page 70](#) for the **Network Setting > Broadband** screen.

Computers can connect to the Device's LAN ports (or wirelessly).

Figure 1 Device's Internet Access Application

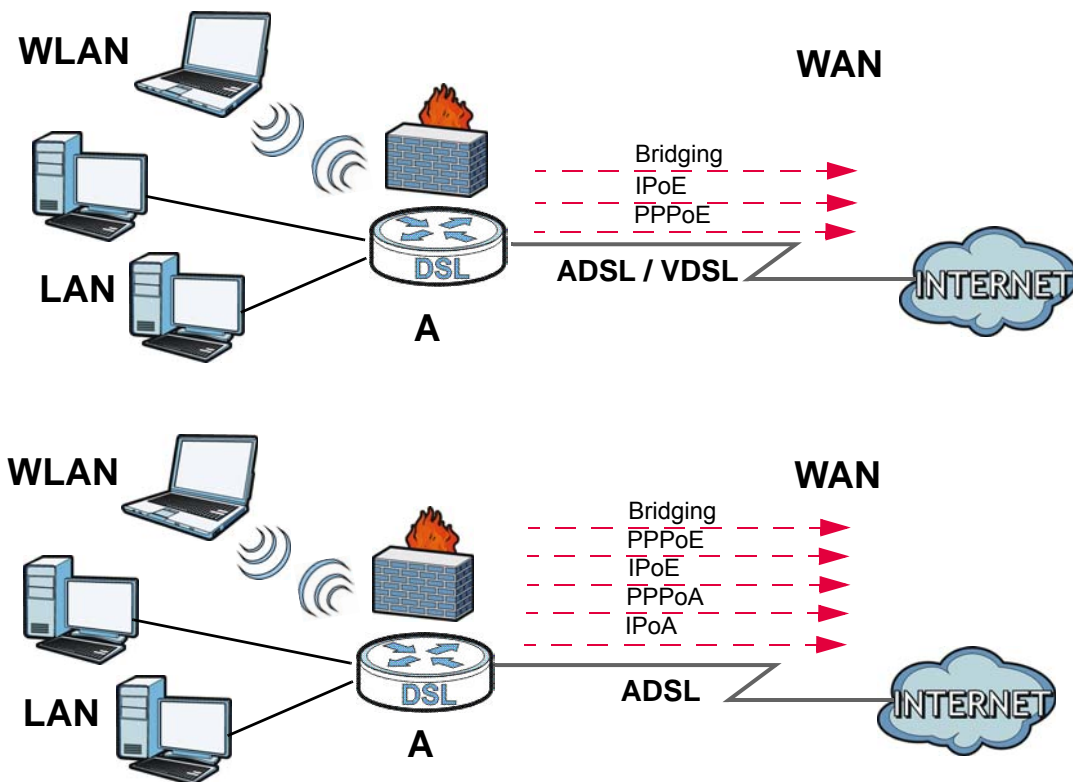

You can also configure IP filtering on the Device for secure Internet access. When the IP filter is on, all incoming traffic from the Internet to your network is blocked by default unless it is initiated from your network. This means that probes from the outside to your network are not allowed, but you can safely browse the Internet and download files.

1.4.2 Device's USB Support

The USB port of the Device is used for file-sharing, media server and printer-sharing.

File Sharing

Use the built-in USB 2.0 port to share files on a USB memory stick or a USB hard drive (**B**). You can connect one USB hard drive to the Device at a time. Use FTP to access the files on the USB device.

Figure 2 USB File Sharing Application

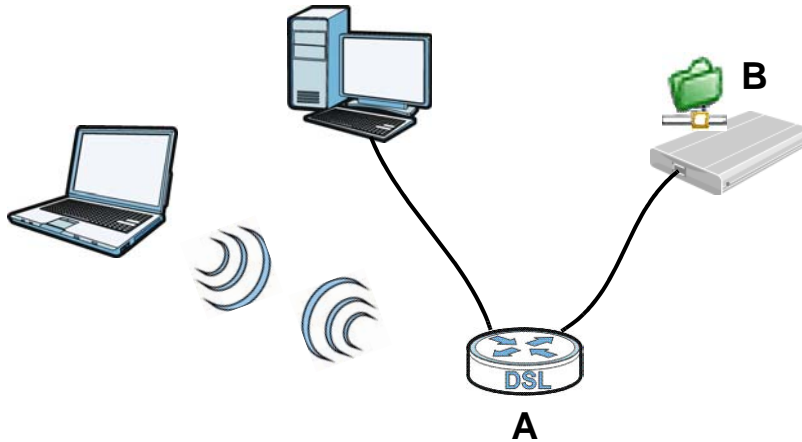

Media Server

You can also use the Device as a media server. This lets anyone on your network play video, music, and photos from a USB device (**B**) connected to the Device's USB port (without having to copy them to another computer).

Figure 3 USB Media Server Application

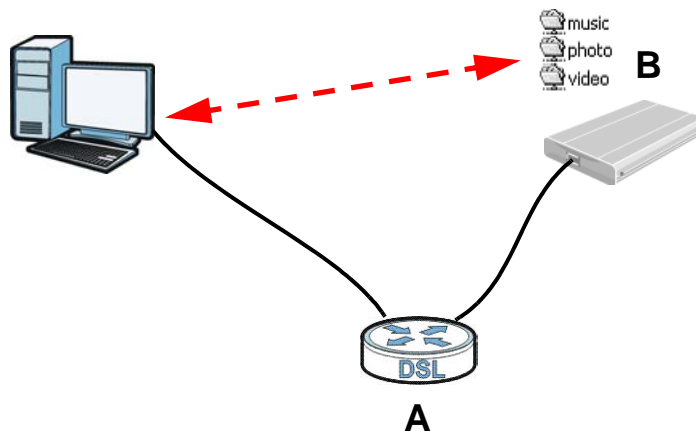

Printer Server

The Device allows you to share a USB printer on your LAN. You can do this by connecting a USB printer to one of the USB ports on the Device and then configuring a TCP/IP port on the computers connected to your network.

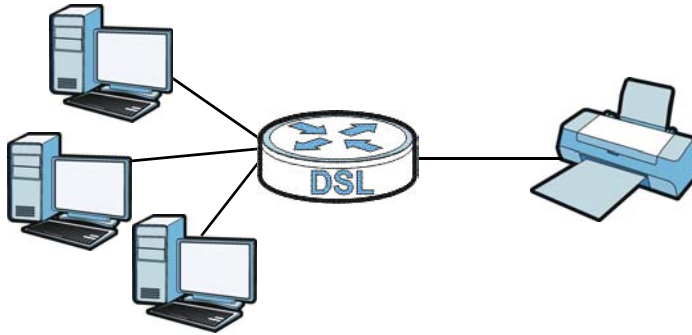
Figure 4 Sharing a USB Printer

1.5 LEDs (Lights)

The following graphic displays the labels of the LEDs.

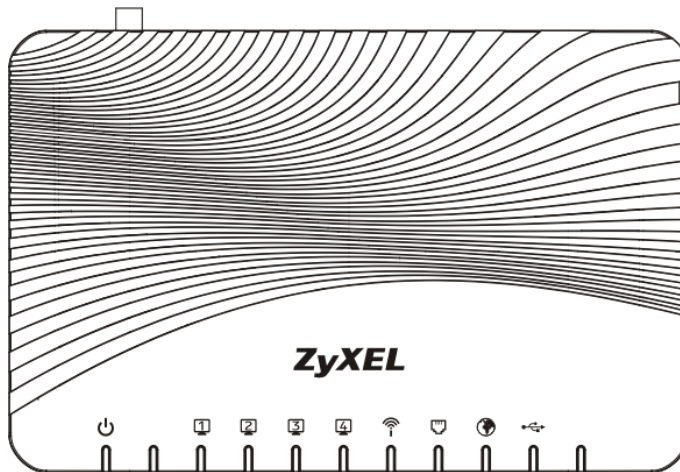
Figure 5 LEDs on the Device

None of the LEDs are on if the Device is not receiving power.

Table 1 LED Descriptions

LED	COLOR	STATUS	DESCRIPTION
POWER	Green	On	The Device is receiving power and ready for use.
		Blinking	The Device is self-testing.
	Red	On	The Device detected an error while self-testing, or there is a device malfunction.
		Off	The Device is not receiving power.
ETHERNET 1-4	Green	On	The Device has a successful 100 Mbps Ethernet connection with a device on the Local Area Network (LAN).
		Blinking	The Device is sending or receiving data to/from the LAN at 100 Mbps.
		Off	The Device does not have an Ethernet connection with the LAN.

Table 1 LED Descriptions (continued)

LED	COLOR	STATUS	DESCRIPTION
WLAN/WPS	Green	On	The wireless network is activated.
		Blinking	The Device is communicating with other wireless clients.
	Orange	Blinking	The Device is setting up a WPS connection.
		Off	The wireless network is not activated.
DSL	Green	On	The ADSL line is up.
		Blinking	The Device is initializing the ADSL line.
	Orange	On	The VDSL line is up.
		Blinking	The Device is initializing the VDSL line.
	Off	The DSL line is down.	
INTERNET	Green	On	The Device has an IP connection but no traffic. Your device has a WAN IP address (either static or assigned by a DHCP server), PPP negotiation was successfully completed (if used) and the DSL connection is up.
		Blinking	The Device is sending or receiving IP traffic.
		Off	There is no Internet connection or the gateway is in bridged mode.
	Red	On	The Device attempted to make an IP connection but failed. Possible causes are no response from a DHCP server, no PPPoE response, PPPoE authentication failed.
USB	Green	On	The Device recognizes a USB connection.
		Blinking	The Device is sending/receiving data to /from the USB device connected to it.
		Off	The Device does not detect a USB connection.

1.6 The RESET Button

If you forget your password or cannot access the Web Configurator, you will need to use the **RESET** button at the back of the device to reload the factory-default configuration file. This means that you will lose all configurations that you had previously and the password will be reset to "1234".

- 1 Make sure the **PWR/SYS** LED is on (not blinking).
- 2 To set the device back to the factory default settings, press the **RESET** button for ten seconds or until the **PWR/SYS** LED begins to blink and then release it. When the **PWR/SYS** LED begins to blink, the defaults have been restored and the device restarts.

1.7 Wireless Access

The Device is a wireless Access Point (AP) for wireless clients, such as notebook computers or PDAs and iPads. It allows them to connect to the Internet without having to rely on inconvenient Ethernet cables.

You can configure your wireless network in either the built-in Web Configurator, or using the WPS button.

Figure 6 Wireless Access Example

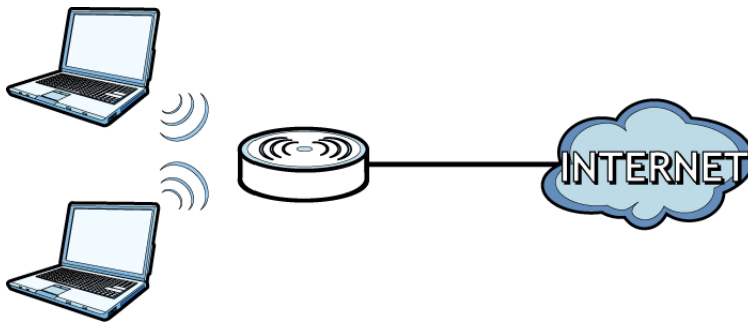

1.7.1 Using the WLAN/WPS Button

If the wireless network is turned off, press the **WLAN/WPS** button at the back of the Device for one second. Once the **WLAN/WPS** LED turns green, the wireless network is active.

You can also use the **WLAN/WPS** button to quickly set up a secure wireless connection between the Device and a WPS-compatible client by adding one device at a time.

To activate WPS:

- 1 Make sure the **POWER** LED is on and not blinking.
- 2 Press the **WLAN/WPS** button for five seconds and release it.
- 3 Press the WPS button on another WPS-enabled device within range of the Device. The **WLAN/WPS** LED flashes orange while the Device sets up a WPS connection with the other wireless device.
- 4 Once the connection is successfully made, the **WLAN/WPS** LED shines green.

To turn off the wireless network, press the **WLAN/WPS** button on the front of the Device for one to five seconds. The **WLAN/WPS** LED turns off when the wireless network is off.

The Web Configurator

2.1 Overview

The web configurator is an HTML-based management interface that allows easy Device setup and management via Internet browser. Use Internet Explorer 8.0 and later versions or Mozilla Firefox 3 and later versions or Safari 2.0 and later versions. The recommended screen resolution is 1024 by 768 pixels.

In order to use the web configurator you need to allow:

- Web browser pop-up windows from your Device. Web pop-up blocking is enabled by default in Windows XP SP (Service Pack) 2.
- JavaScript (enabled by default).
- Java permissions (enabled by default).

2.1.1 Accessing the Web Configurator

- 1 Make sure your Device hardware is properly connected (refer to the Quick Start Guide).
- 2 Launch your web browser. If the Device does not automatically re-direct you to the login screen, go to <http://192.168.1.1>.
- 3 A password screen displays. To access the administrative web configurator and manage the Device, type the default username **admin** and password **1234** in the password screen and click **Login**. If advanced account security is enabled (see [Section 30.2 on page 251](#)) the number of dots that appears when you type the password changes randomly to prevent anyone watching the password field from knowing the length of your password. If you have changed the password, enter your password and click **Login**.

Figure 7 Password Screen

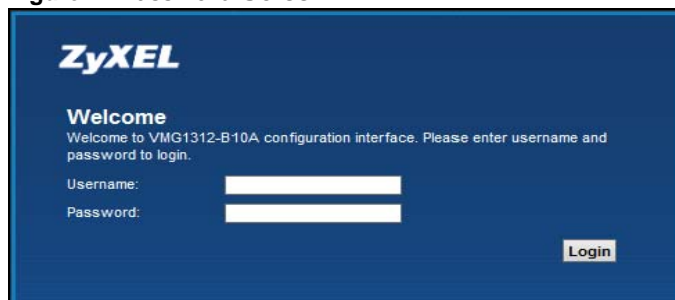

- 4 The following screen displays if you have not yet changed your password. It is strongly recommended you change the default password. Enter a new password, retype it to confirm and click **Apply**; alternatively click **Skip** to proceed to the main menu if you do not want to change the password now.

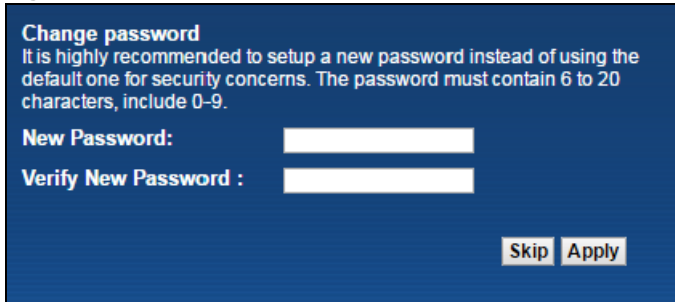
Figure 8 Change Password Screen

Change password
It is highly recommended to setup a new password instead of using the default one for security concerns. The password must contain 6 to 20 characters, include 0-9.

New Password:

Verify New Password :

- 5 The **Quick Start Wizard** screen appears. You can configure basic Internet access, and wireless settings. See [Chapter 3 on page 31](#) for more information.
- 6 After you finished or closed the **Quick Start Wizard** screen, the **Network Map** page appears.

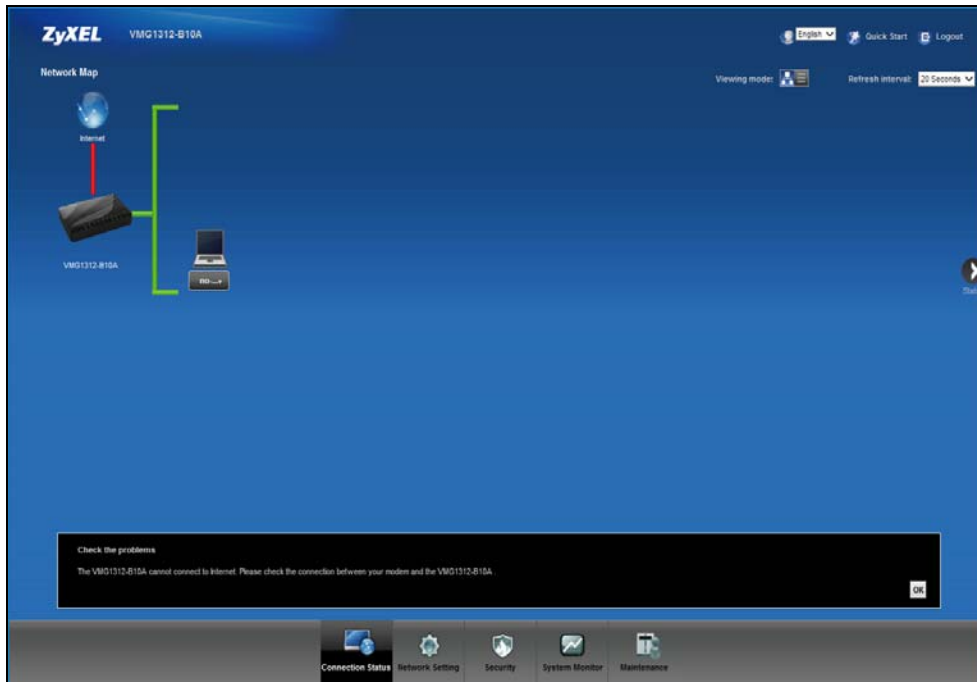
Figure 9 Network Map

- 7 Click **Status** to display the **Status** screen, where you can view the Device's interface and system information.

2.2 Web Configurator Layout

Figure 10 Screen Layout

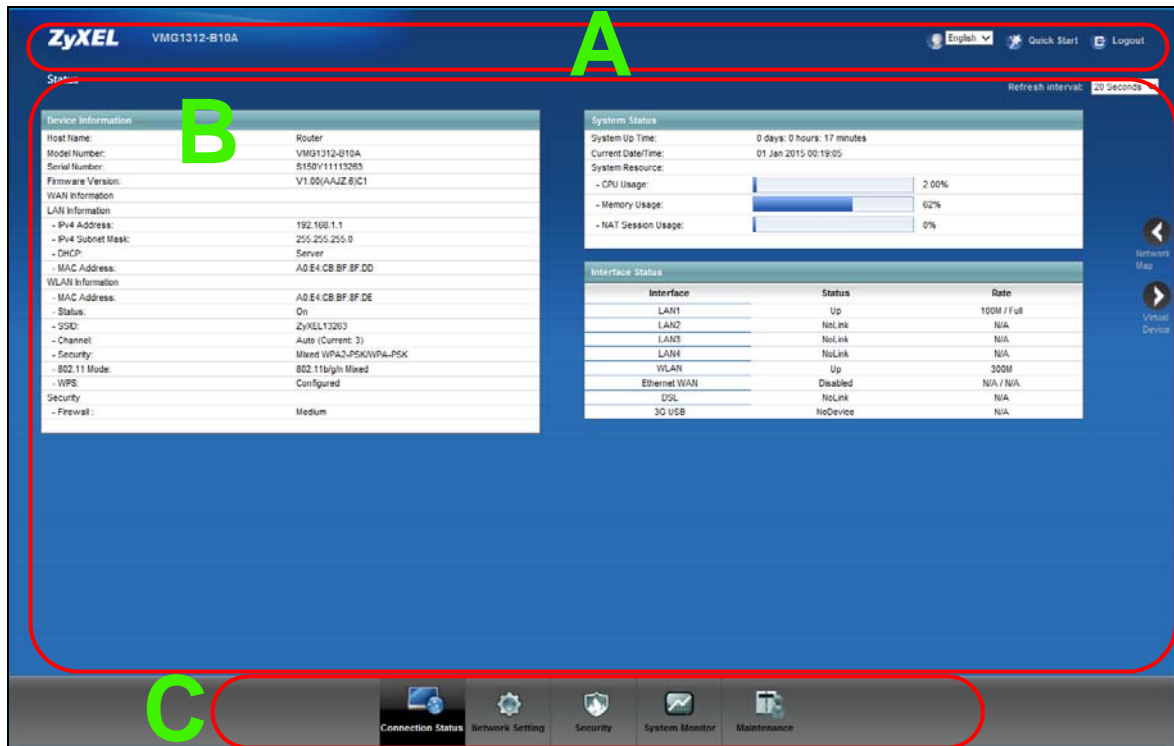

As illustrated above, the main screen is divided into these parts:

- **A** - title bar
- **B** - main window
- **C** - navigation panel

2.2.1 Title Bar

The title bar provides some icons in the upper right corner.

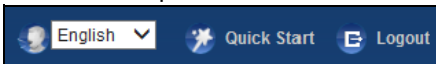

The icons provide the following functions.

Table 2 Web Configurator Icons in the Title Bar

ICON	DESCRIPTION
	Language: Select the language you prefer.
	Quick Start: Click this icon to open screens where you can configure the Device's time zone Internet access, and wireless settings.
	Logout: Click this icon to log out of the web configurator.

2.2.2 Main Window

The main window displays information and configuration fields. It is discussed in the rest of this document.

After you click **Status** on the **Connection Status** page, the **Status** screen is displayed. See [Chapter 5 on page 63](#) for more information about the **Status** screen.

If you click **Virtual Device** on the **System Info** screen, a visual graphic appears, showing the connection status of the Device's ports. The connected ports are in color and disconnected ports are gray.

Figure 11 Virtual Device

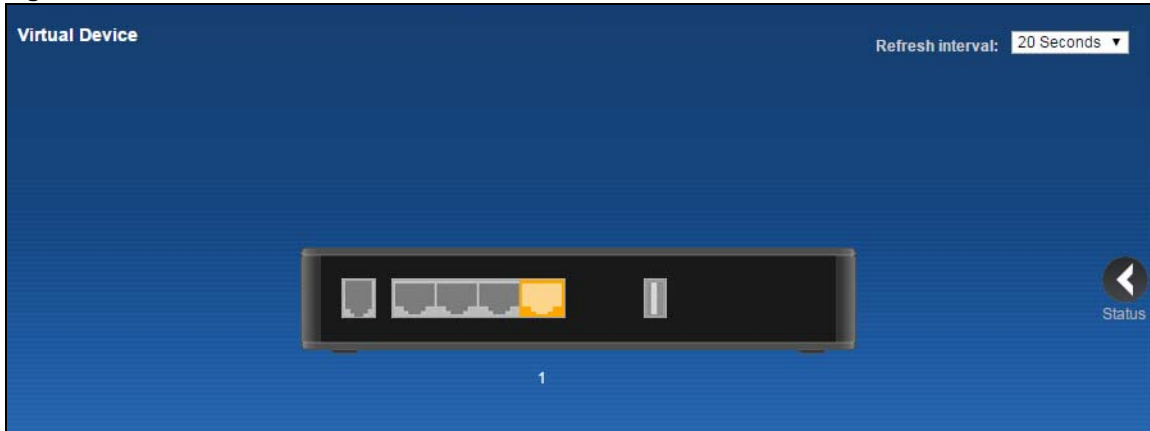

2.2.3 Navigation Panel

Use the menu items on the navigation panel to open screens to configure Device features. The following tables describe each menu item.

Table 3 Navigation Panel Summary

LINK	TAB	FUNCTION
Connection Status		This screen shows the network status of the Device and computers/ devices connected to it.
Network Setting		
Broadband	Broadband	Use this screen to view and configure ISP parameters, WAN IP address assignment, and other advanced properties. You can also add new WAN connections.
	3G Backup	Use this screen to configure 3G WAN connection.
	Advanced	Use this screen to enable or disable PTM over ADSL, Annex M/Annex J, and DSL PhyR functions.
	802.1x	Use this screen to view and configure the IEEE 802.1x settings on the Device.
	Ethernet WAN	Use this screen to convert Ethernet LAN 4 port as WAN port, or restore the WAN port to LAN port.

Table 3 Navigation Panel Summary (continued)

LINK	TAB	FUNCTION
Wireless	General	Use this screen to configure the wireless LAN settings and WLAN authentication/security settings.
	Guest/More AP	Use this screen to configure multiple BSSs on the Device.
	MAC Authentication	Use this screen to block or allow wireless traffic from wireless devices of certain SSIDs and MAC addresses to the Device.
	WPS	Use this screen to configure and view your WPS (Wi-Fi Protected Setup) settings.
	WMM	Use this screen to enable or disable Wi-Fi MultiMedia (WMM).
	WDS	Use this screen to set up Wireless Distribution System (WDS) links to other access points.
	Others	Use this screen to configure advanced wireless settings.
	Channel Status	Use this screen to scan wireless LAN channel noises and view the results.
Home Networking	LAN Setup	Use this screen to configure LAN TCP/IP settings, and other advanced properties.
	Static DHCP	Use this screen to assign specific IP addresses to individual MAC addresses.
	UPnP	Use this screen to turn UPnP and UPnP NAT-T on or off.
	Additional Subnet	Use this screen to configure IP alias and public static IP.
	STB Vendor ID	Use this screen to have the Device automatically create static DHCP entries for Set Top Box (STB) devices when they request IP addresses.
	TFTP Server Name	Use DHCP option 66 to identify a TFTP server name.
Routing	Static Route	Use this screen to view and set up static routes on the Device.
	DNS Route	Use this screen to forward DNS queries for certain domain names through a specific WAN interface to its DNS server(s).
	Policy Forwarding	Use this screen to configure policy routing on the Device.
	RIP	Use this screen to configure Routing Information Protocol to exchange routing information with other routers.
QoS	General	Use this screen to enable QoS and traffic prioritizing. You can also configure the QoS rules and actions.
	Queue Setup	Use this screen to configure QoS queues.
	Class Setup	Use this screen to define a classifier.
	Policer Setup	Use these screens to configure QoS policers.
NAT	Port Forwarding	Use this screen to make your local servers visible to the outside world.
	Applications	Use this screen to configure servers behind the Device.
	Port Triggering	Use this screen to change your Device's port triggering settings.
	DMZ	Use this screen to configure a default server which receives packets from ports that are not specified in the Port Forwarding screen.
	ALG	Use this screen to enable or disable SIP ALG.
	Address Mapping	Use this screen to change your Device's address mapping settings.
	Sessions	Use this screen to configure the maximum number of NAT sessions each client host is allowed to have through the Device.

Table 3 Navigation Panel Summary (continued)

LINK	TAB	FUNCTION
DNS	DNS Entry	Use this screen to view and configure DNS routes.
	Dynamic DNS	Use this screen to allow a static hostname alias for a dynamic IP address.
IGMP/MLD		Use this screen to configure multicast settings (IGMP for IPv4 and MLD for IPv6 multicast groups) on the WAN.
Vlan Group	Vlan Group	Use this screen to group and tag VLAN IDs to outgoing traffic from the specified interface.
Interface Group		Use this screen to map a port to a PVC or bridge group.
USB Service	File Sharing	Use this screen to enable file sharing via the Device.
	Media Server	Use this screen to use the Device as a media server.
	Print Server	Use this screen to enable the print server on the Device and get the model name of the associated printer.
Power Management	Power Management	This screen is only available for administrators. Use this screen to manually turn on/off specific interface(s) and/or all LEDs immediately.
	Auto Switch Off	This screen is only available for administrators. Use this screen to configure schedules to have the Device automatically turn on/off specific interface(s) and/or all LEDs.
Security		
Firewall	General	Use this screen to configure the security level of your firewall.
	Protocol	Use this screen to add Internet services and configure firewall rules.
	Access Control	Use this screen to enable specific traffic directions for network services.
	DoS	Use this screen to activate protection against Denial of Service (DoS) attacks.
MAC Filter		Use this screen to block or allow traffic from devices of certain MAC addresses to the Device.
Parental Control		Use this screen to block web sites with the specific URL.
Scheduler Rules		Use this screen to configure the days and times when a configured restriction (such as parental control) is enforced.
Certificates	Local Certificates	Use this screen to view a summary list of certificates and manage certificates and certification requests.
	Trusted CA	Use this screen to view and manage the list of the trusted CAs.
System Monitor		

Table 3 Navigation Panel Summary (continued)

LINK	TAB	FUNCTION
Log	System Log	Use this screen to view the status of events that occurred to the Device. You can export or e-mail the logs.
	Security Log	Use this screen to view all security related events. You can select level and category of the security events in their proper drop-down list window. Levels include: <ul style="list-style-type: none"> • Emergency • Alert • Critical • Error • Warning • Notice • Informational • Debugging Categories include: <ul style="list-style-type: none"> • Firewall • MAC Filter • Forward Web Sites • Blocked Web Sites • Attack • Certificate • IPSec • Account
Traffic Status	WAN	Use this screen to view the status of all network traffic going through the WAN port of the Device.
	LAN	Use this screen to view the status of all network traffic going through the LAN ports of the Device.
	NAT	Use this screen to view NAT statistics for connected hosts.
ARP table		Use this screen to view the ARP table. It displays the IP and MAC address of each DHCP connection.
Routing Table		Use this screen to view the routing table on the Device.
IGMP/MLD Group Status		Use this screen to view the status of all IGMP/MLD settings on the Device.
xDSL Statistics		Use this screen to view the VMG1312-B Series's xDSL traffic statistics.
3G Statistics		Use this screen to look at 3G Internet connection status.
Maintenance		
User Account	User Account	Use this screen to change user password on the Device.
Remote MGMT		Use this screen to enable specific traffic directions for network services.
TR-069 Client		Use this screen to configure the Device to be managed by an Auto Configuration Server (ACS).
TR-064		Use this screen to enable management via TR-064 on the LAN.
SNMP		Use this screen to configure SNMP (Simple Network Management Protocol) settings.
Time		Use this screen to change your Device's time and date.
Email Notification		Use this screen to configure up to two mail servers and sender addresses on the Device.

Table 3 Navigation Panel Summary (continued)

LINK	TAB	FUNCTION
Log Setting		Use this screen to change your Device's log settings.
Firmware Upgrade		Use this screen to upload firmware to your Device.
Configuration		Use this screen to backup and restore your Device's configuration (settings) or reset the factory default settings.
Reboot		Use this screen to reboot the Device without turning the power off.
Diagnostic	Ping&Traceroute &Nslookup	Use this screen to identify problems with the DSL connection. You can use Ping, TraceRoute, or Nslookup to help you identify problems.
	802.1ag	Use this screen to configure CFM (Connectivity Fault Management) MD (maintenance domain) and MA (maintenance association), perform connectivity tests and view test reports.
	OAM Ping	Use this screen to view information to help you identify problems with the DSL connection.

Quick Start

3.1 Overview

Use the Quick Start screens to configure the Device's time zone, basic Internet access, and wireless settings.

Note: See the technical reference chapters (starting on [Chapter 4 on page 33](#)) for background information on the features in this chapter.

3.2 Quick Start Setup

- 1 The Quick Start Wizard appears automatically after login. Or you can click the **Click Start** icon in the top right corner of the web configurator to open the quick start screens. Click **Next**.

Figure 12 Quick Start - Welcome

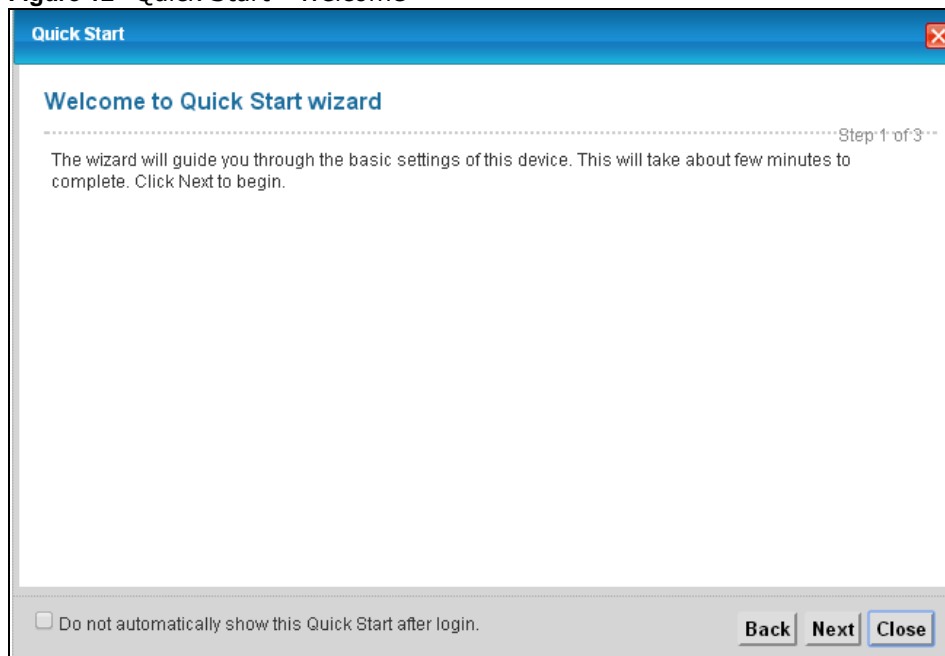

- 2 Enter your Internet connection information in this screen. The screen and fields to enter may vary depending on your current connection type. Click **Next**.

Figure 13 Quick Start - Internet Connection

Quick Start ✕

Internet Connection Step 2 of 3

The current connection type is set to **PPPoE** and needs a user name and password to get online.

User Name:

Password:

Is there specific IP address information from your Internet Service Provider (ISP)?

Yes No

Then the IP Address information will be dynamically assigned to you from your ISP.

Do not automatically show this Quick Start after login. Back Next Close

- 3 Turn the wireless LAN on or off. If you keep it on, record the security settings so you can configure your wireless clients to connect to the Device. Click **Save**.

Figure 14 Quick Start - Wireless

Quick Start ✕

Wireless Setting Step 3 of 3

The following settings are the current wireless settings which your wireless client devices need in order to get connected to this device.

Wireless Service: Enable Disable

Wireless Network Name (SSID): ZyXEL000001

Security: WPA2-PSK

Password: 432D54BEE98C

Do not automatically show this Quick Start after login. Back Save Close

- 4 Your Device saves your settings and attempts to connect to the Internet.

4.1 Overview

This chapter shows you how to use the Device's various features.

- [Setting Up an ADSL PPPoE Connection](#), see page 33
- [Setting Up a Secure Wireless Network](#), see page 36
- [Setting Up Multiple Wireless Groups](#), see page 42
- [Configuring Static Route for Routing to Another Network](#), see page 45
- [Configuring QoS Queue and Class Setup](#), see page 47
- [Access the Device Using DDNS](#), see page 51
- [Configuring the MAC Address Filter](#), see page 52
- [Access Your Shared Files From a Computer](#), see page 53
- [Using the Print Server Feature](#), see page 54

4.2 Setting Up an ADSL PPPoE Connection

This tutorial shows you how to set up an ADSL Internet connection using the Web Configurator.

If you connect to the Internet through an ADSL connection, use the information from your Internet Service Provider (ISP) to configure the Device. Be sure to contact your service provider for any information you need to configure the **Broadband** screens.

- 1 Click **Network Setting > Broadband** to open the following screen. Click **Add New WAN Interface**.

#	Name	Type	Mode	Enca...	802.1p	802.1q	IGMP Proxy	NAT	Default Gateway	IPv6	MLD Proxy	Modify
1	ADSL	ATM	Routing	IPoE	N/A	N/A	Y	Y	Y	Y	N	

- 2 In this example, the DSL connection has the following information.

General	
Name	MyDSLConnection

Type	ADSL
Connection Mode	Routing
Encapsulation	PPPoE
IPv6/IPv4 Mode	IPv4
ATM PVC Configuration	
VPI/VCI	36/48
Encapsulation Mode	LLC/SNAP-Bridging
Service Category	UBR without PCR
Account Information	
PPP User Name	1234@DSL-Ex.com
PPP Password	ABCDEF!
PPPoE Service Name	MyDSL
Static IP Address	192.168.1.32
Others	Authentication Method: AUTO PPPoE Passthrough: Disabled NAT: Enabled IGMP Multicast Proxy: Enabled Apply as Default Gateway: Enabled VLAN: Disabled

- 3 Select the **Active** check box. Enter the **General** and **ATM PVC Configuration** settings as provided above.

Set the **Type** to **ADSL over ATM**.

Choose the **Encapsulation** specified by your DSL service provider. For this example, the service provider requires a username and password to establish Internet connection. Therefore, select **PPPoE** as the WAN encapsulation type.

Set the **IPv6/IPv4 Mode** to **IPv4 Only**.

- 4 Enter the account information provided to you by your DSL service provider.
- 5 Configure this rule as your default Internet connection by selecting the **Apply as Default Gateway** check box. Then select DNS as **Static** and enter the DNS server addresses provided to you, such as **192.168.5.2** (DNS server1)/**192.168.5.1** (DNS server2).
- 6 Leave the rest of the fields to the default settings.
- 7 Click **Apply** to save your settings.

WAN Configuration ✖

General

Active:

Name: MyDSLConnection

Type: ADSL over ATM

Mode: Routing

Encapsulation: PPPoE

IPv6/IPv4 Mode: IPv4 Only

ATM PVC Configuration

VPI [0-255]: 36

VCI [32-65535]: 48

DSL Link Type: EoA

Encapsulation Mode: LLC/SNAP-BRIDGING

Service Category: UBR Without PCR

PPP Information

PPP User Name: 234@DSL-Ex.com

PPP Password: password unmask

PPP Trigger Type: Auto Connect Connect on Demand Manual

Authentication Method: AUTO

Idle Timeout [minutes]: 5

PPPoE Service Name: MyDSL

PPPoE Passthrough:

IP Address

Obtain an IP Address Automatically

Static IP Address

IP Address: 192.168.1.32

Subnet Mask: 0.0.0.0

Gateway IP Address: 0.0.0.0

Routing Feature

NAT Enable:

Fullcone NAT Enable:

IGMP Proxy Enable:

Apply as Default Gateway:

DNS server

DNS: Dynamic Static

DNS Server 1: 192.168.5.2

DNS Server 2: 192.168.5.1

Tunnel

Enable 6RD: Enable Disable

6RD Type: DHCP Static

IPv4 Mask Length:

6RD Border Relay Server IP:

6RD IPv6 Prefix:

VLAN

Active:

802.1p: 0

802.1q: (0-4094)

QoS

Rate Limit: (kbps)

WAN Outgoing Default Tag: Enable Disable

DSCP: (0-63)

MTU

MTU Size: 1492 MTU [68-1492]

- 8 You should see a summary of your new DSL connection setup in the **Broadband** screen as follows.

#	Name	Type	Mode	Encap...	802.1p	802.1q	IGMP Proxy	NAT	Default Gateway	IPv6	MLD Proxy	Modify
1	ADSL	ATM	Routing	IPoE	N/A	N/A	Y	Y	Y	Y	N	
2	MyDS...	ATM	Routing	PPPoE	N/A	N/A	Y	Y	Y	N	N	
3	VDSL	PTM	Routing	IPoE	N/A	N/A	Y	Y	Y	Y	N	

Try to connect to a website to see if you have correctly set up your Internet connection. Be sure to contact your service provider for any information you need to configure the WAN screens.

4.3 Setting Up a Secure Wireless Network

Thomas wants to set up a wireless network so that he can use his notebook to access the Internet. In this wireless network, the Device serves as an access point (AP), and the notebook is the wireless client. The wireless client can access the Internet through the AP.



Thomas has to configure the wireless network settings on the Device. Then he can set up a wireless network using WPS ([Section 4.3.2 on page 37](#)) or manual configuration ([Section 4.3.3 on page 41](#)).

4.3.1 Configuring the Wireless Network Settings

This example uses the following parameters to set up a wireless network.

SSID	Example
Security Mode	WPA2-PSK
Pre-Shared Key	DoNotStealMyWirelessNetwork
802.11 Mode	802.11b/g/n Mixed

- 1 Click **Network Setting** > **Wireless** to open the **General** screen. Select **More Secure** as the security level and **WPA2-PSK** as the security mode. Configure the screen using the provided parameters (see [page 36](#)). Click **Apply**.

Wireless Network Setup

Band: 2.4GHz

Wireless: Enable Disable (settings are invalid when disabled)

Channel: Auto Current: 2

Bandwidth: 20MHz

Wireless Network Settings

Wireless Network Name(SSID): ZyXEL_DD34

Max clients: 16

Hide SSID

Multicast Forwarding

Max. Upstream Bandwidth: Kbps

Max. Downstream Bandwidth: Kbps

BSSID: 10:20:30:11:22:34

Security Level



The Security Level slider shows three levels: No Security (red), Basic (yellow), and More Secure (Recommended) (green). A blue dot is positioned on the 'More Secure (Recommended)' level.

Apply Cancel

- Go to the **Wireless > Others** screen and select **802.11b/g/n Mixed** in the **802.11 Mode** field. Click **Apply**.

Wireless Advanced Setup

RTS/CTS Threshold: 2347

Fragmentation Threshold: 2346

Auto Channel Timer: 0 min

Output Power: 100%

Beacon Interval: 100 ms

DTIM Interval: 1 ms

802.11 Mode: 802.11b/g/n Mixed

802.11 Protection: Auto

Preamble: Long

Thomas can now use the WPS feature to establish a wireless connection between his notebook and the Device (see [Section 4.3.2 on page 37](#)). He can also use the notebook's wireless client to search for the Device (see [Section 4.3.3 on page 41](#)).

4.3.2 Using WPS

This section shows you how to set up a wireless network using WPS. It uses the Device as the AP and ZyXEL NWD210N as the wireless client which connects to the notebook.

Note: The wireless client must be a WPS-aware device (for example, a WPS USB adapter or PCMCIA card).

There are two WPS methods to set up the wireless client settings:

- **Push Button Configuration (PBC)** - simply press a button. This is the easier of the two methods.
- **PIN Configuration** - configure a Personal Identification Number (PIN) on the Device. A wireless client must also use the same PIN in order to download the wireless network settings from the Device.

Push Button Configuration (PBC)

- 1 Make sure that your Device is turned on and your notebook is within the cover range of the wireless signal.
- 2 Make sure that you have installed the wireless client driver and utility in your notebook.
- 3 In the wireless client utility, go to the WPS setting page. Enable WPS and press the WPS button (**Start** or **WPS** button).
- 4 Push and hold the **WPS** button located on the Device's front panel for more than 5 seconds. Alternatively, you may log into Device's web configurator and go to the **Network Setting > Wireless > WPS** screen. Enable the WPS function for method 1 and click **Apply**. Then click the **Connect** button.

General Guest/More AP MAC Authentication **WPS** WMM WDS Others Channel Status

Wi-Fi Protected Setup (WPS) lets you set up wireless security easily. Select a method for establishing a WPS connection between the router and another WPS-compatible device.

2.4GHz WPS Setup

WPS :

Method 1	Method 2	Method 3
<p>Method 1 <input checked="" type="radio"/> Enable <input type="radio"/> Disabled</p> <p>Push Button Configuration</p> <p>1. Click "Connect".</p> <p>Connect</p> <p>2. Activate WPS on the wireless client within 2 minutes after clicking "Connect".</p>	<p>Method 2 <input type="radio"/> Enable <input type="radio"/> Disabled</p> <p>Register Wireless Client PIN Number</p> <p>1. Enter the PIN of your wireless client and click "Register".</p> <p><input type="text"/> Register</p> <p>2. Activate WPS on the wireless client within 2 minutes after clicking "Connect".</p>	<p>Method 3 <input type="radio"/> Enable <input type="radio"/> Disabled</p> <p>Enter AP's PIN Number in Wireless Client</p> <p>Current state: Configured</p> <p>1. Please release configuration if you want to configure the wireless settings.</p> <p>Release Configuration</p> <p>2. Enter current PIN 19457970 on your wireless client.</p> <p>Generate New PIN Number</p>

Notes:

1. The WPS function only works on the first SSID for 2.4 and 5GHz respectively. Guest WLAN's cannot be used with WPS.
2. Click the "Release Configuration" button to have the WPS status changed to "Unconfigured". Otherwise, WPS status is in "Configured" mode.

Apply **Cancel**

Note: Your Device has a WPS button located on its front panel as well as a WPS button in its configuration utility. Both buttons have exactly the same function: you can use one or the other.

Note: It doesn't matter which button is pressed first. You must press the second button within two minutes of pressing the first one.

The Device sends the proper configuration settings to the wireless client. This may take up to two minutes. The wireless client is then able to communicate with the Device securely.

The following figure shows you an example of how to set up a wireless network and its security by pressing a button on both Device and wireless client.

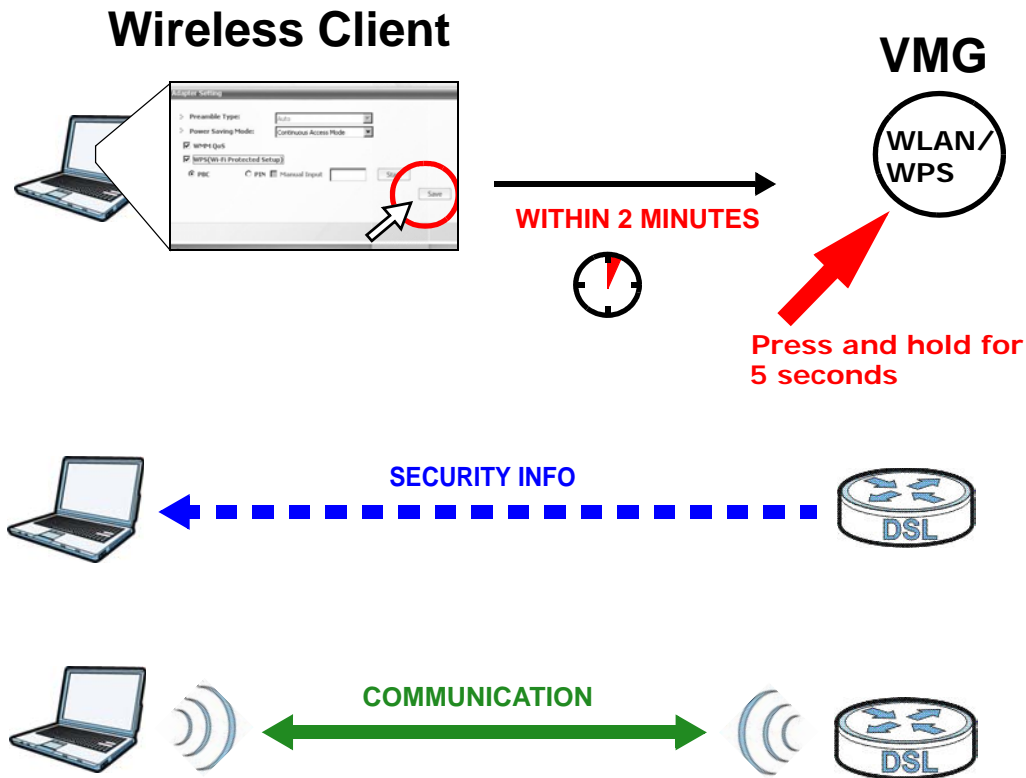

PIN Configuration

When you use the PIN configuration method, you need to use both the Device's web configurator and the wireless client's utility.

- 1 Launch your wireless client's configuration utility. Go to the WPS settings and select the PIN method to get a PIN number.
- 2 Log into Device's web configurator and go to the **Network Setting > Wireless > WPS** screen. Enable the WPS function and click **Apply**.

Wi-Fi Protected Setup (WPS) lets you set up wireless security easily. Select a method for establishing a WPS connection between the router and another WPS-compatible device.

2.4GHz WPS Setup

WPS :

Method 1	Method 2	Method 3
<input checked="" type="radio"/> Enable <input type="radio"/> Disabled Push Button Configuration 1. Click 'Connect'. <input type="button" value="Connect"/> 2. Activate WPS on the wireless client within 2 minutes after clicking "Connect".	<input checked="" type="radio"/> Enable <input type="radio"/> Disabled Register Wireless Client PIN Number 1. Enter the PIN of your wireless client and click 'Register'. <input type="text"/> <input type="button" value="Register"/> 2. Activate WPS on the wireless client within 2 minutes after clicking "Connect".	<input type="radio"/> Enable <input type="radio"/> Disabled Enter AP's PIN Number in Wireless Client Current state: Configured 1. Please release configuration if you want to configure the wireless settings. <input type="button" value="Release Configuration"/> 2. Enter current PIN 19457970 on your wireless client. <input type="button" value="Generate New PIN Number"/>

Notes:

- The WPS function only works on the first SSID for 2.4 and 5GHz respectively. Guest WLAN's cannot be used with WPS.
- Click the 'Release Configuration' button to have the WPS status changed to 'Unconfigured'. Otherwise, WPS status is in 'Configured' mode.

- Enter the PIN number of the wireless client and click the **Register** button. Activate WPS function on the wireless client utility screen within two minutes.

The Device authenticates the wireless client and sends the proper configuration settings to the wireless client. This may take up to two minutes. The wireless client is then able to communicate with the Device securely.

The following figure shows you how to set up a wireless network and its security on a Device and a wireless client by using PIN method.

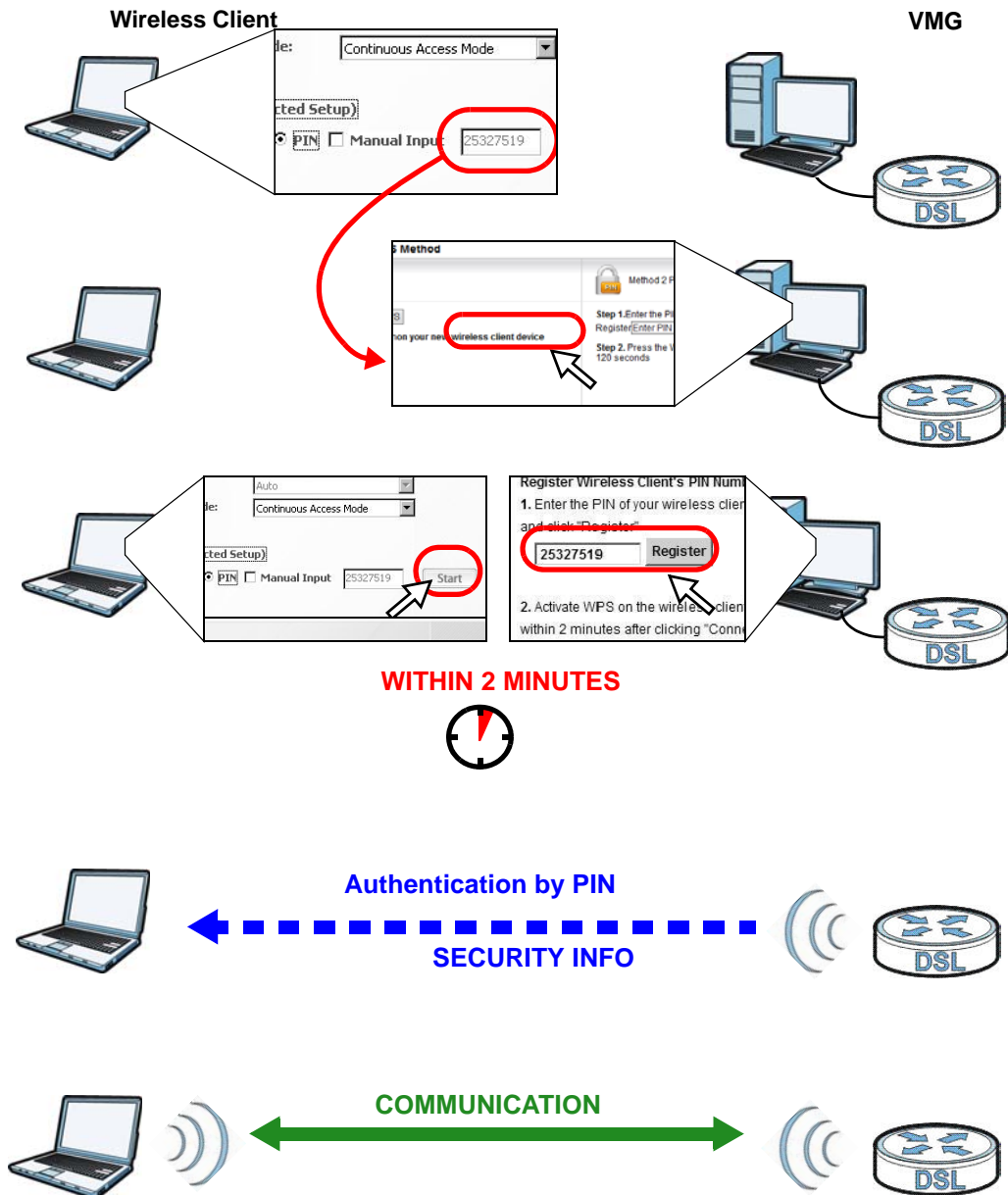

4.3.3 Without WPS

Use the wireless adapter's utility installed on the notebook to search for the "Example" SSID. Then enter the "DoNotStealMyWirelessNetwork" pre-shared key to establish an wireless Internet connection.

Note: The Device supports IEEE 802.11b and IEEE 802.11g wireless clients. Make sure that your notebook or computer's wireless adapter supports one of these standards.

4.4 Setting Up Multiple Wireless Groups

Company A wants to create different wireless network groups for different types of users as shown in the following figure. Each group has its own SSID and security mode.

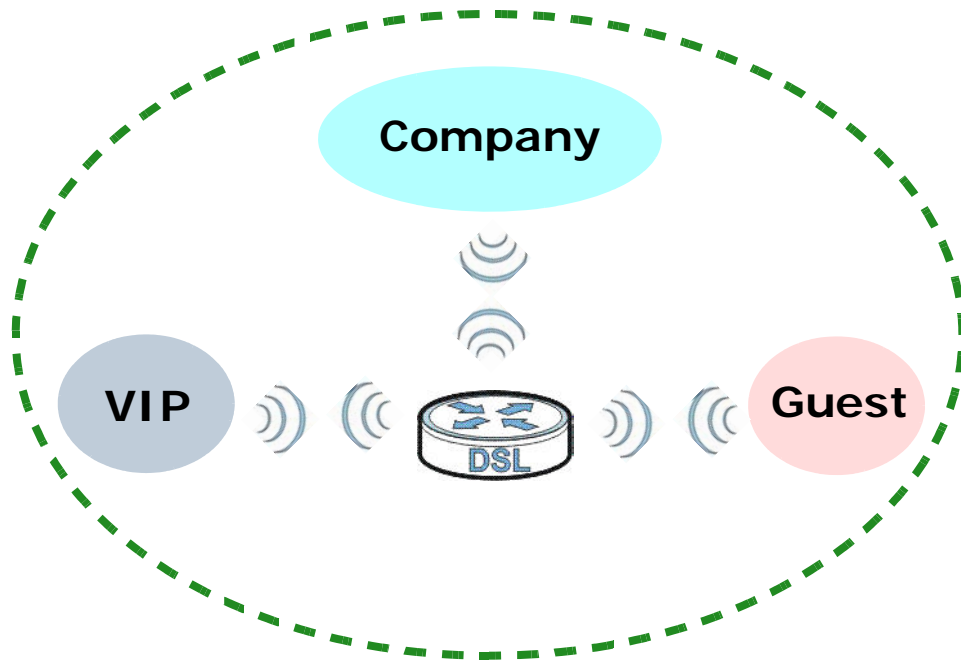

- Employees in Company A will use a general **Company** wireless network group.
- Higher management level and important visitors will use the **VIP** group.
- Visiting guests will use the **Guest** group, which has a different SSID and password.

Company A will use the following parameters to set up the wireless network groups.

	COMPANY	VIP	GUEST
SSID	Company	VIP	Guest
Security Level	More Secure	More Secure	More Secure
Security Mode	WPA2-PSK	WPA2-PSK	WPA2-PSK
Pre-Shared Key	ForCompanyOnly	123456789	guest123

- 1 Click **Network Setting > Wireless** to open the **General** screen. Use this screen to set up the company's general wireless network group. Configure the screen using the provided parameters and click **Apply**.

Wireless Network Setup

Band :

Wireless Enable Disabled (settings are invalid when disabled)

Channel : Current: 13 [more...](#)

Wireless Network Settings

Wireless Network Name (SSID) :

Max clients:

Hide SSID

Enhanced Multicast Forwarding

Max. Upstream Bandwidth: Kbps

Max. Downstream Bandwidth: Kbps

Notes:

1. Max. Upstream Bandwidth: This field allow user configure the maximum bandwidth of this SSID to WAN.
2. Max. Downstream Bandwidth: This field allow user configure the maximum bandwidth of WAN to this SSID.
3. If Max. Upstream/Downstream Bandwidth is empty, the CPE sets the value automatically.

BSSID: CC:5D:4E:00:00:02

E-mail notification when the wireless guest visit

Enable Email Notification

Security Level

No Security Basic **More Secure (Recommended)**

Security Mode:

Generate password automatically

Enter 8-63 characters (a-z, A-Z, 0-9, '-', '_', and '.'). other characters are not allowed.

Password: [more...](#)

password unmask

- 2 Click **Network Setting > Wireless > Guest/More AP** to open the following screen. Click the **Edit** icon to configure the second wireless network group.

General **Guest/More AP** MAC Authentication WPS WMM WDS Others Channel Status

This device can enable up to 4 wireless networks to work at the same time. Assign a name and a security level (if needed) to start the 2nd, 3rd, and 4th wireless network services.

#	Status	SSID	Security	Guest WLAN	Modify
1		ZyXEL000001_Guest1	Mixed WPA2-PSK/WPA-PSK	External Guest	
2		ZyXEL000001_Guest2	Mixed WPA2-PSK/WPA-PSK	N/A	
3		ZyXEL000001_Guest3	Mixed WPA2-PSK/WPA-PSK	N/A	

- 3 Configure the screen using the provided parameters and click **Apply**.

Wireless Network Setup

Wireless : **Enable** Disabled (The settings in this screen are invalid if you select this.)

Passphrase Type :

Wireless Network Settings

Wireless Network Name(SSID):

Max clients:

Hide SSID

Enhanced Multicast Forwarding

Guest WLAN

Access Scenario:

Max. Upstream Bandwidth: Kbps

Max. Downstream Bandwidth: Kbps

Notes:

- 1.Max. Upstream Bandwidth:This field allow user configure the maximum bandwidth of this SSID to WAN.
- 2.Max. Downstream Bandwidth:This field allow user configure the maximum bandwidth of WAN to this SSID.
- 3.If Max. Upstream/Downstream Bandwidth is empty, the CPE sets the value automatically.

E-mail notification when the wireless guest visit

Enable Email Notification

SSID Subnet: Enable Disabled

Security Level

No Security Basic **More Secure (Recommended)**

Security Mode:

Generate password automatically
Enter 8-63 characters (a-z, A-Z, 0-9, '-', '_' and '!'), other characters are not allowed.

Password: [more...](#)

password unmask

- 4 In the **Guest/More AP** screen, click the **Edit** icon to configure the third wireless network group. Configure the screen using the provided parameters and click **Apply**.

Wireless Network Setup

Wireless : Enable Disabled (The settings in this screen are invalid if you select this.)

Passphrase Type :

Wireless Network Settings

Wireless Network Name(SSID):

Max clients:

Hide SSID

Enhanced Multicast Forwarding

Guest WLAN

Access Scenario:

Max. Upstream Bandwidth: Kbps

Max. Downstream Bandwidth: Kbps

Notes:

- 1.Max. Upstream Bandwidth:This field allow user configure the maximum bandwidth of this SSID to WAN.
- 2.Max. Downstream Bandwidth:This field allow user configure the maximum bandwidth of WAN to this SSID.
- 3.If Max. Upstream/Downstream Bandwidth is empty, the CPE sets the value automatically.

E-mail notification when the wireless guest visit

Enable Email Notification

SSID Subnet: Enable Disabled

Security Level

No Security Basic **More Secure (Recommended)**

Security Mode:

Generate password automatically
Enter 8-63 characters (a-z, A-Z, 0-9, '-', '_', and '!'), other characters are not allowed.

Password: [more...](#)

password unmask

OK Cancel

- 5 Check the status of **VIP** and **Guest** in the **Guest/More AP** screen. The yellow bulbs signify that the SSIDs are active and ready for wireless access.

#	Status	SSID	Security	Guest WLAN	Modify
1		ZyXEL000001_Guest1	Mixed WPA2-PSK/WPA-PSK	N/A	
2		VIP	Mixed WPA2-PSK/WPA-PSK	External Guest	
3		Guest	Mixed WPA2-PSK/WPA-PSK	External Guest	

4.5 Configuring Static Route for Routing to Another Network

In order to extend your Intranet and control traffic flowing directions, you may connect a router to the Device's LAN. The router may be used to separate two department networks. This tutorial shows how to configure a static routing rule for two network routings.

In the following figure, router **R** is connected to the Device's LAN. **R** connects to two networks, **N1** (192.168.1.x/24) and **N2** (192.168.10.x/24). If you want to send traffic from computer **A** (in **N1** network) to computer **B** (in **N2** network), the traffic is sent to the Device's WAN default gateway by default. In this case, **B** will never receive the traffic.

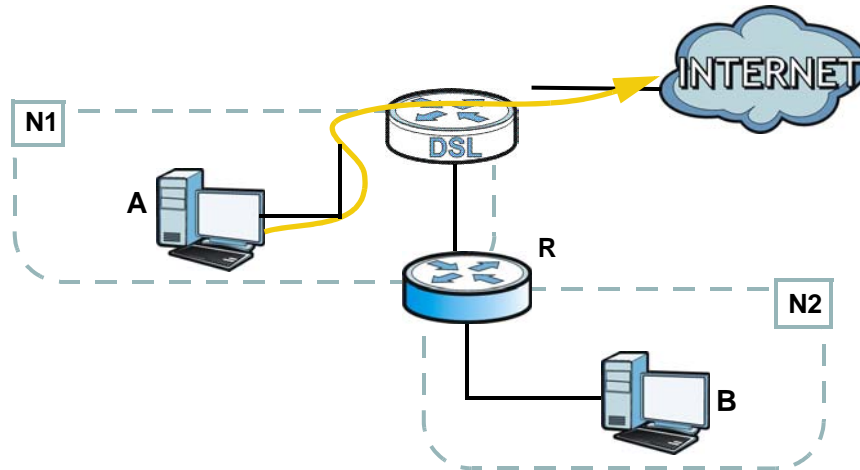

You need to specify a static routing rule on the Device to specify **R** as the router in charge of forwarding traffic to **N2**. In this case, the Device routes traffic from **A** to **R** and then **R** routes the traffic to **B**.

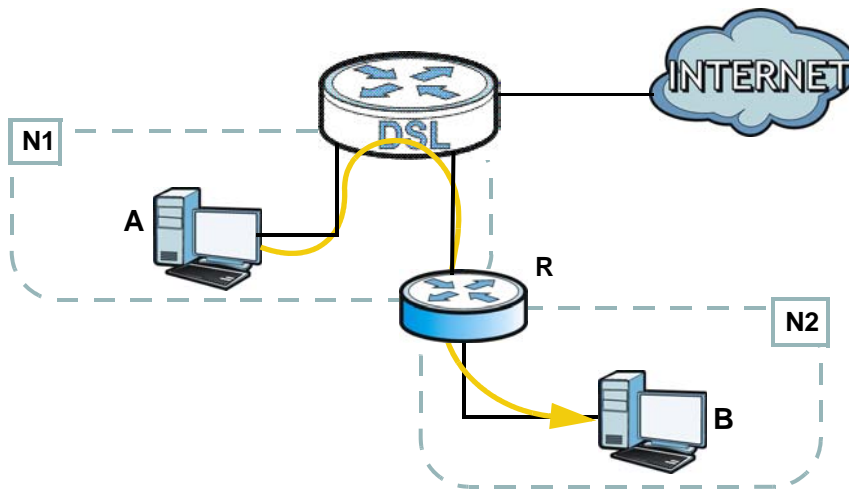

This tutorial uses the following example IP settings:

Table 4 IP Settings in this Tutorial

DEVICE / COMPUTER	IP ADDRESS
The Device's WAN	172.16.1.1
The Device's LAN	192.168.1.1
IP Type	IPv4
Use Interface	VDSL/ppp1.1
A	192.168.1.34

Table 4 IP Settings in this Tutorial

DEVICE / COMPUTER	IP ADDRESS
R's N1	192.168.1.253
R's N2	192.168.10.2
B	192.168.10.33

To configure a static route to route traffic from **N1** to **N2**:

- 1 Log into the Device's Web Configurator in advanced mode.
- 2 Click **Network Setting > Routing**.
- 3 Click **Add new Static Route** in the **Static Route** screen.

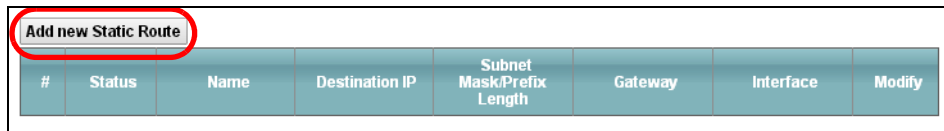

- 4 Configure the **Static Route Setup** screen using the following settings:
 - 4a Select the **Active** check box. Enter the **Route Name** as **R**.
 - 4b Set **IP Type** to **IPv4**.
 - 4c Type **192.168.10.0** and subnet mask **255.255.255.0** for the destination, **N2**.
 - 4d Select **Enable** in the **Use Gateway IP Address** field. Type **192.168.1.253** (**R**'s N1 address) in the **Gateway IP Address** field.
 - 4e Select **VDSL/ppp1.1** as the **Use Interface**.

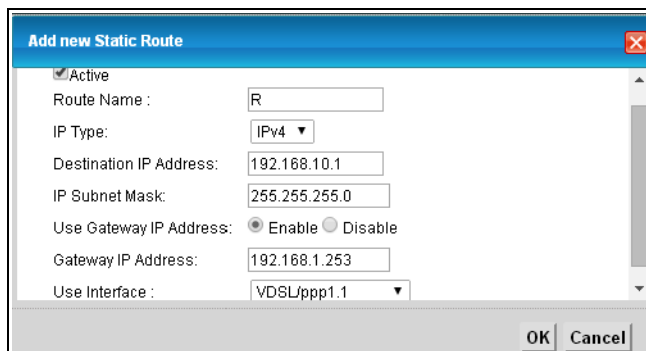

- 4a Click **OK**.

Now **B** should be able to receive traffic from **A**. You may need to additionally configure **B**'s firewall settings to allow specific traffic to pass through.

4.6 Configuring QoS Queue and Class Setup

This section contains tutorials on how you can configure the QoS screen.

Let's say you are a team leader of a small sales branch office. You want to prioritize e-mail traffic because your task includes sending urgent updates to clients at least twice every hour. You also upload data files (such as logs and e-mail archives) to the FTP server throughout the day. Your colleagues use the Internet for research, as well as chat applications for communicating with other branch offices.

In the following figure, your Internet connection has an upstream transmission bandwidth of 10,000 kbps. For this example, you want to configure QoS so that e-mail traffic gets the highest priority with at least 5,000 kbps. You can do the following:

- Configure a queue to assign the highest priority queue (1) to e-mail traffic going to the WAN interface, so that e-mail traffic would not get delayed when there is network congestion.
- Note the IP address (192.168.1.23 for example) and/or MAC address (AA:FF:AA:FF:AA:FF for example) of your computer and map it to queue 7.

Note: QoS is applied to traffic flowing out of the Device.

Traffic that does not match this class is assigned a priority queue based on the internal QoS mapping table on the Device.

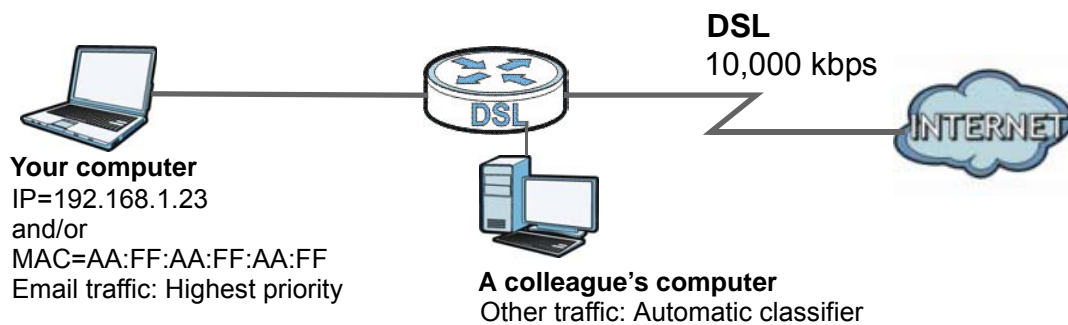

- 1 Click **Network Setting > QoS > General** and select **Enable**. Set your **WAN Managed Upstream Bandwidth** to 10,000 kbps (or leave this blank to have the Device automatically determine this figure). Click **Apply**.

QoS Enable Disable (settings are invalid when disabled)

WAN Managed Upstream Bandwidth : (kbps)

LAN Managed Downstream Bandwidth : (kbps)

Upstream traffic priority Assigned by:

Note:

You can assign the upstream bandwidth manually. If the field is empty, the CPE sets the value automatically.

If Enable QoS checkbox is selected, choose a default DSCP mark to automatically mark incoming traffic without reference to a particular classifier.

If the setting of WAN managed upstream bandwidth is greater than current WAN interface linkup rate, then the WAN managed upstream bandwidth will become current WAN interface linkup rate.

- 2 Click **Queue Setup > Add new Queue** to create a new queue. In the screen that opens, check **Active** and enter or select the following values:

- **Name:** E-mail

- **Interface:** WAN
- **Priority:** 1 (High)
- **Weight:** 8
- **Rate Limit:** 5,000 (kbps)

The screenshot shows a dialog box titled "Add new Queue". It contains the following settings:

- Active
- Name : E-mail
- Interface : WAN
- Priority : 1 (High)
- Weight : 1
- Buffer Management : Drop Tail (DT)
- Rate Limit (kbps) : 5000 (kbps)

Buttons: OK, Cancel

- 3 Click **Class Setup** > **Add new Classifier** to create a new class. Check **Active** and follow the settings as shown in the screen below.

Please follow the guidance through step 1~5 to configure a QoS rule

Step1: Class Configuration

Active

Class Name :

Classification Order :

Step2: Criteria configuration

Use the configurations below to specify the characteristics of a data flow need to be managed by this QoS rule

▪ **Basic**

From Interface :

Ether Type :

▪ **Source**

Address Subnet Netmask Exclude

Port Range ~ Exclude

MAC MAC Mask Exclude

▪ **Destination**

Address Subnet Netmask Exclude

Port Range ~ Exclude

MAC MAC Mask Exclude

▪ **Others**

Service Exclude

IP protocol Exclude

DHCP Exclude

Packet Length ~ Exclude

DSCP (0~63) Exclude

802.1P Exclude

VLAN ID (0~4094) Exclude

TCP ACK Exclude

Step3: Packet modification

The content of the packet can be modified by applying the following settings:

DSCP Mark : (0~63)

802.1P Mark :

VLAN ID : (0~4094)

Step4: Policy Forwarding

This module can route or bridge packets to certain interface according to the class settings:

Forward To Interface :

Step5: Outgoing queue selection

Outgoing queue decide the priority of the traffic and how traffic should be shaped in the WAN interface. Choose "None" if you don't want to apply outgoing queue

To Queue Index :

Class Name	Give a class name to this traffic, such as E-mail in this example.
From Interface	This is the interface from which the traffic will be coming from. Select LAN1 for this example.
Ether Type	Select IP to identify the traffic source by its IP address or MAC address.
IP Address	Type the IP address of your computer - 192.168.1.23 . Type the IP Subnet Mask if you know it.
MAC Address	Type the MAC address of your computer - AA:FF:AA:FF:AA:FF . Type the MAC Mask if you know it.
To Queue Index	Link this to an item in the Network Setting > QoS > Queue Setup screen, which is the E-mail queue created in this example.

This maps e-mail traffic coming from port 25 to the highest priority, which you have created in the previous screen (see the **IP Protocol** field). This also maps your computer's IP address and MAC address to the **E-mail** queue (see the **Source** fields).

- 4 Verify that the queue setup works by checking **Network Setting > QoS > Monitor**. This shows the bandwidth allotted to e-mail traffic compared to other network traffic.

4.7 Access the Device Using DDNS

If you connect your Device to the Internet and it uses a dynamic WAN IP address, it is inconvenient for you to manage the device from the Internet. The Device's WAN IP address changes dynamically. Dynamic DNS (DDNS) allows you to access the Device using a domain name.

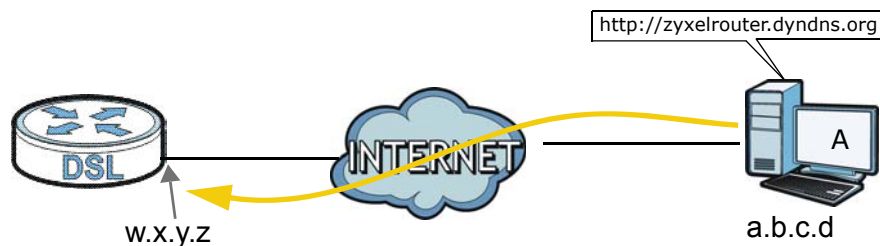

To use this feature, you have to apply for DDNS service at www.dyndns.org.

This tutorial covers:

- [Registering a DDNS Account on \[www.dyndns.org\]\(http://www.dyndns.org\)](#)
- [Configuring DDNS on Your Device](#)
- [Testing the DDNS Setting](#)

Note: If you have a private WAN IP address, then you cannot use DDNS.

4.7.1 Registering a DDNS Account on www.dyndns.org

- 1 Open a browser and type **<http://www.dyndns.org>**.
- 2 Apply for a user account. This tutorial uses **UserName1** and **12345** as the username and password.
- 3 Log into www.dyndns.org using your account.
- 4 Add a new DDNS host name. This tutorial uses the following settings as an example.
 - Hostname: **zyxelrouter.dyndns.org**
 - Service Type: **Host with IP address**
 - IP Address: Enter the WAN IP address that your Device is currently using. You can find the IP address on the Device's Web Configurator **Status** page.

Then you will need to configure the same account and host name on the Device later.

4.7.2 Configuring DDNS on Your Device

Configure the following settings in the **Network Setting > DNS > Dynamic DNS** screen.

- Select **Enable Dynamic DNS**.
- Select **www.DynDNS.com** as the service provider.
- Type **zyxelrouter.dyndns.org** in the **Host Name** field.
- Enter the user name (**UserName1**) and password (**12345**).

Dynamic DNS Setup

Dynamic DNS: Enable Disable

Service Provider:

Hostname:

Username:

Password:

Dynamic DNS Status

User Authentication Result:

Last Updated Time:

Current Dynamic IP:

Click **Apply**.

4.7.3 Testing the DDNS Setting

Now you should be able to access the Device from the Internet. To test this:

- 1 Open a web browser on the computer (using the IP address **a.b.c.d**) that is connected to the Internet.
- 2 Type **http://zyxelrouter.dyndns.org** and press [Enter].
- 3 The Device's login page should appear. You can then log into the Device and manage it.

4.8 Configuring the MAC Address Filter

Thomas noticed that his daughter Josephine spends too much time surfing the web and downloading media files. He decided to prevent Josephine from accessing the Internet so that she can concentrate on preparing for her final exams.

Josephine's computer connects wirelessly to the Internet through the Device. Thomas decides to use the **Security > MAC Filter** screen to grant wireless network access to his computer but not to Josephine's computer.

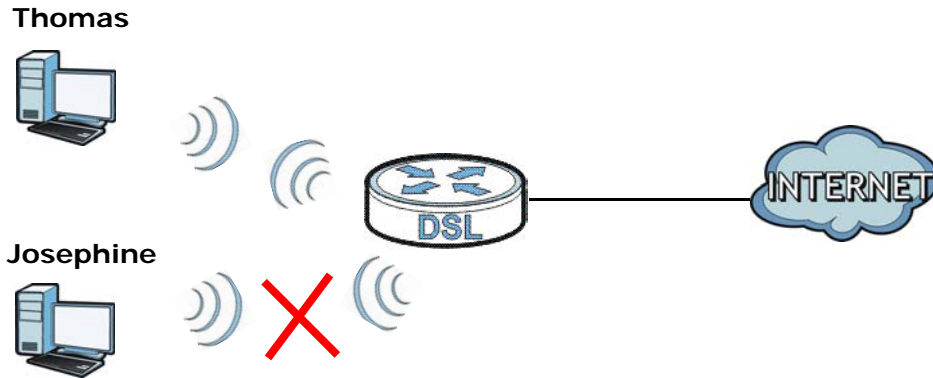

- 1 Click **Security** > **MAC Filter** to open the **MAC Filter** screen. Select the **Enable** check box to activate MAC filter function.
- 2 Select **Allow**. Then enter the host name and MAC address of Thomas' computer in this screen. Click **Apply**.

MAC Address Filter : Enable Disable (settings are invalid when disabled)

MAC Restrict Mode : Allow Deny

Set	Allow	Host name	MAC Address
1	<input checked="" type="checkbox"/>	Thomas	00:24:21:AB:1F:00
2	<input type="checkbox"/>		
3	<input type="checkbox"/>		
4	<input type="checkbox"/>		
5	<input type="checkbox"/>		
30	<input type="checkbox"/>		
31	<input type="checkbox"/>		
32	<input type="checkbox"/>		

Note:
Only devices listed here are granted or prohibit access to the network.

Thomas can also grant access to the computers of other members of his family and friends. However, Josephine and others not listed in this screen will no longer be able to access the Internet through the Device.

4.9 Access Your Shared Files From a Computer

Here is how to use an FTP program to access a file storage device connected to the Device's USB port.

Note: This example uses the FileZilla FTP program to browse your shared files.

- 1 In FileZilla enter the IP address of the Device (the default is 192.168.1.1), your account's user name and password and port 21 and click **Quickconnect**. A screen asking for password authentication appears.

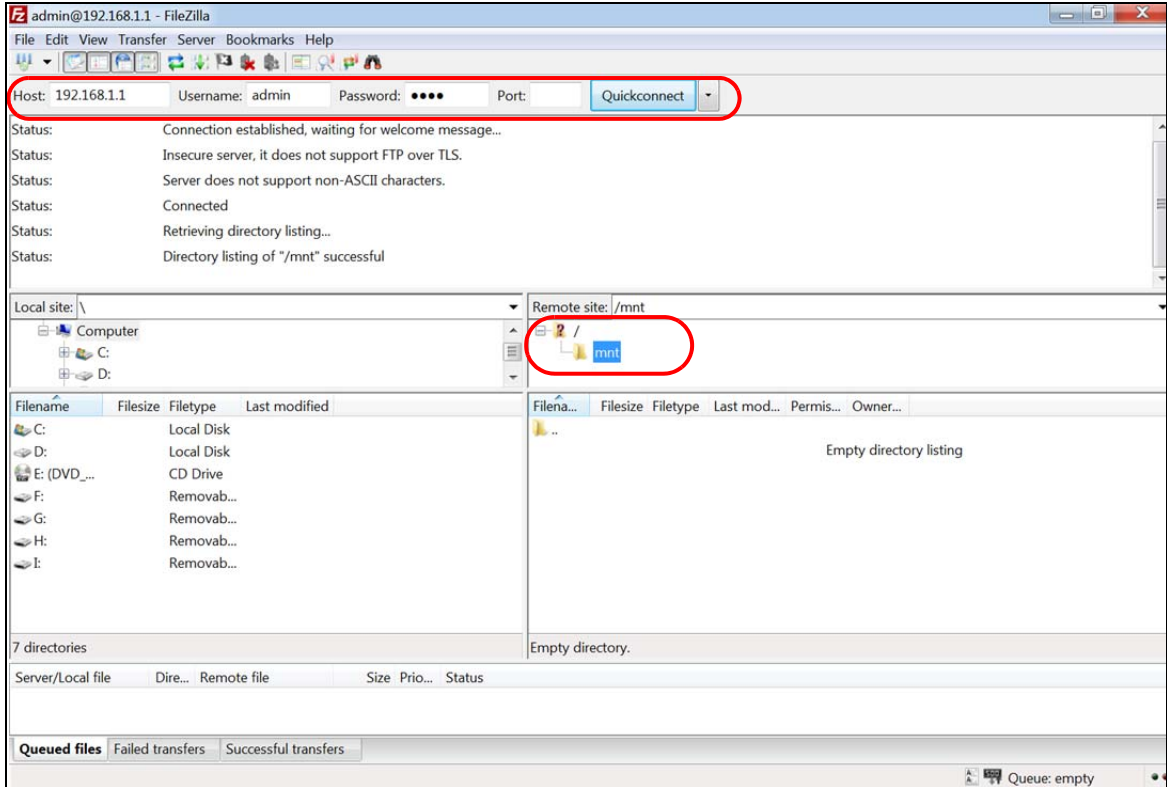

- 2 Once you log in the USB device displays in the **mnt** folder.

4.10 Using the Print Server Feature

The Device allows you to share a USB printer on your LAN. You can do this by connecting a USB printer to one of the USB ports on the Device and then adding the printer on the computers connected to your network.

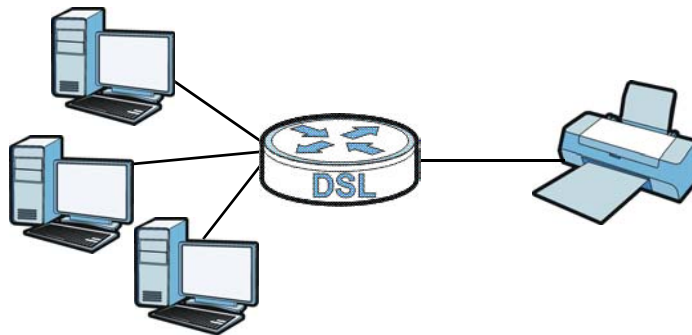

In this section you can:

- Add a New Printer Using Windows
- Add a New Printer Using Macintosh OS X

Add a New Printer Using Windows

This example shows how to connect a printer to your Device using the Windows 7 operating system. Some menu items may look different on your operating system.

- 1 Click **Start > Control Panel > Devices and Printers** to open the **Devices and Printers** screen. Click **Add a printer**.

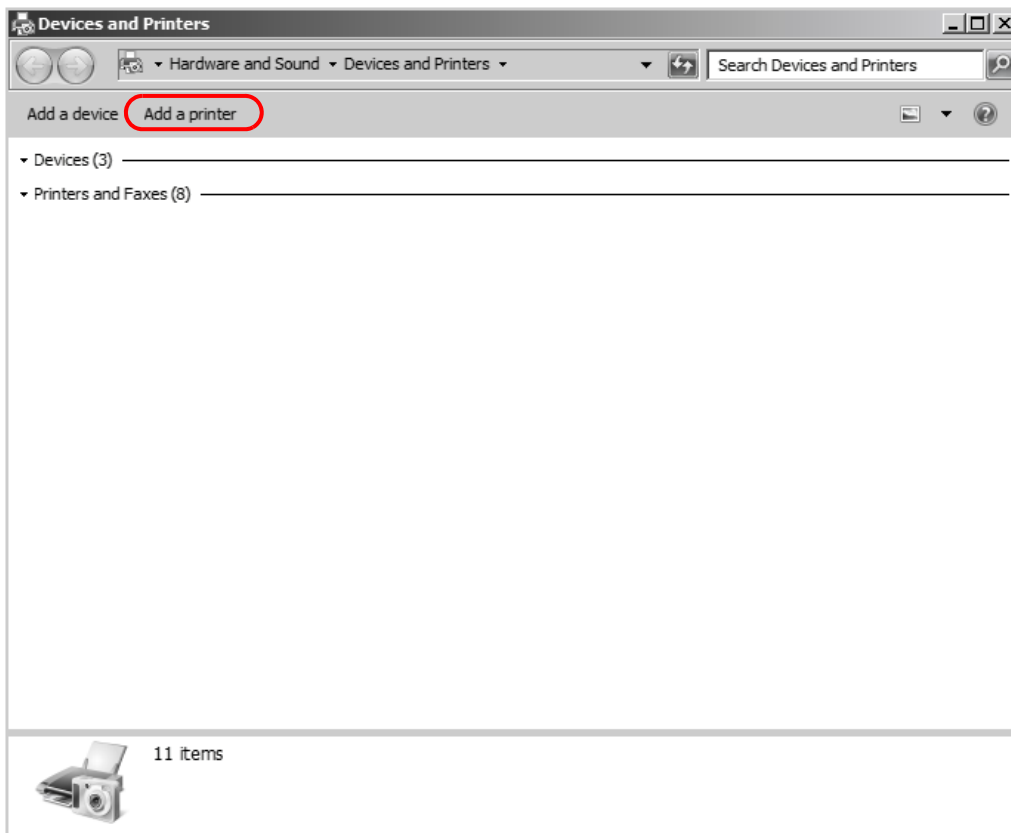

- 2 The **Add Printer** wizard screen displays. Click **Add a network, wireless or Bluetooth printer**.

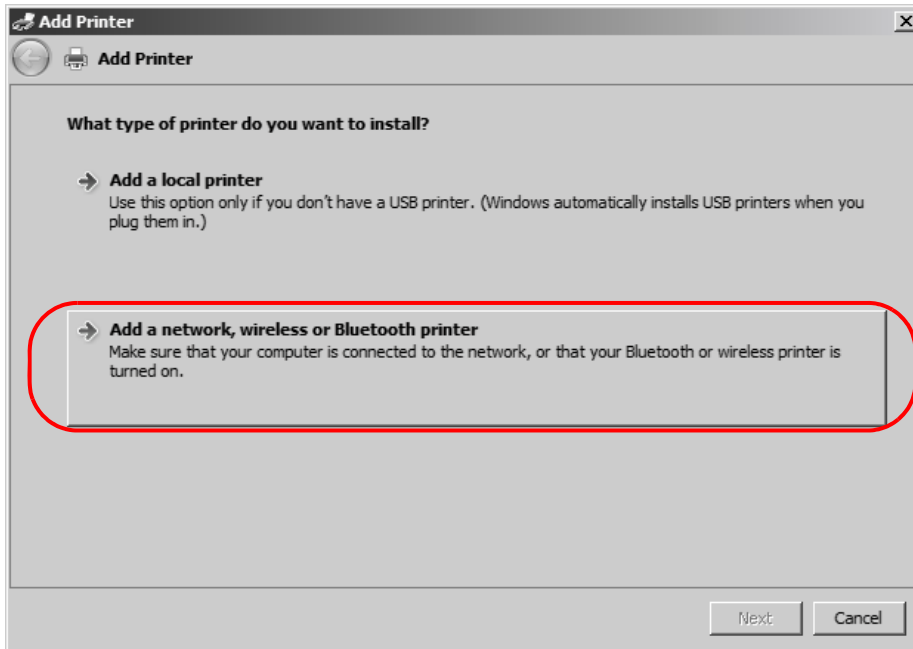

- 3 Click **The printer that I want isn't listed.**

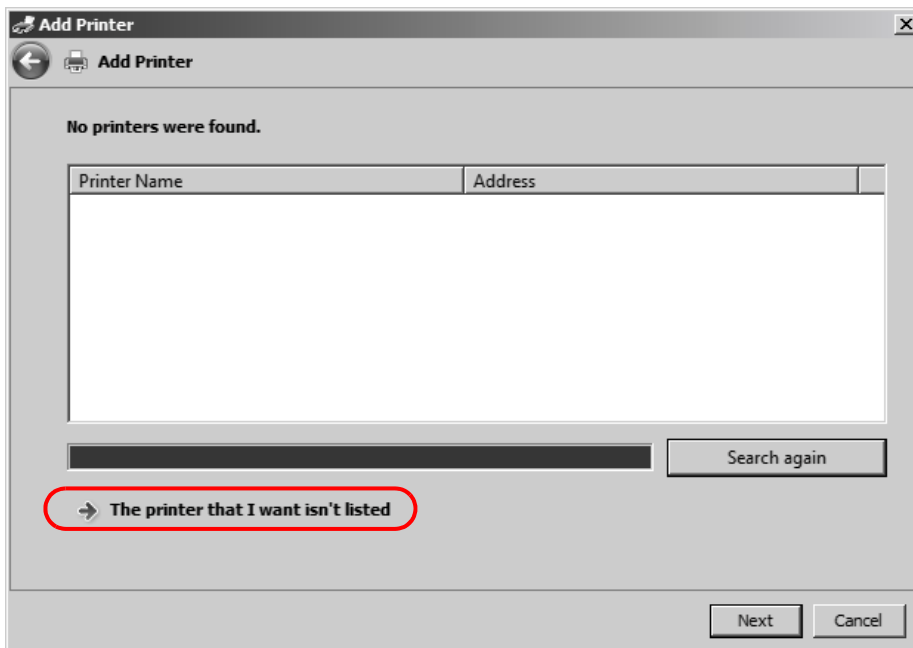

- 4 Select the **Select a shared printer by name** option. Enter the URL for your printer, **http://192.168.1.1:631/printers/USB_PRINTER**, in this example. This URL can be found in the Device's Web Configurator on the **Network Setting > USB Service > Printer Server** screen. Click **Next**.

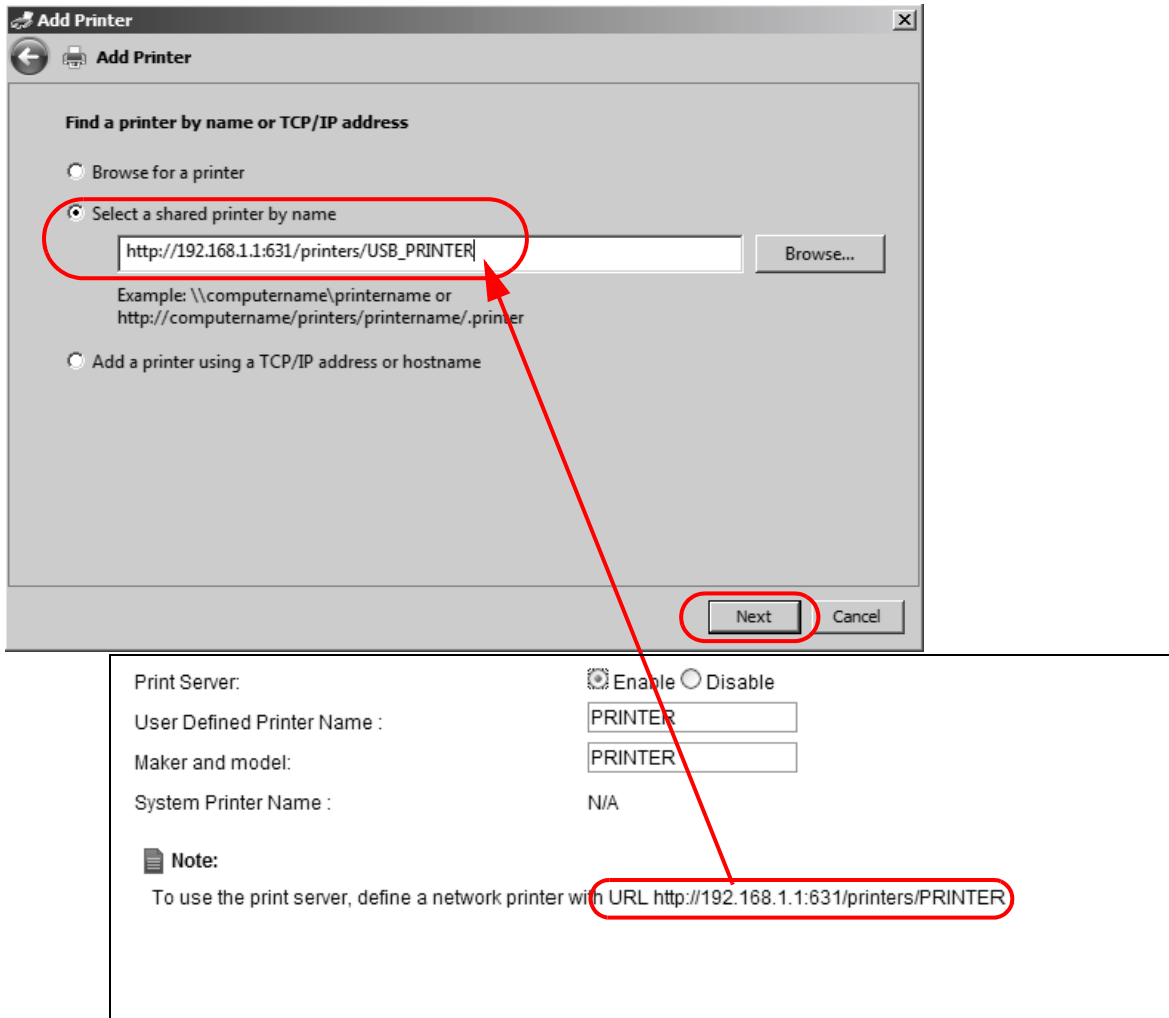

- 5 Install the printer driver. Please check the Windows CD if it includes the printer driver. If not, please install the driver from the CD included with your printer or by downloading it from the printer vendor's website.
- 6 After the printer driver installs successfully, choose if you want to set this printer to be the default.

Add a New Printer Using Macintosh OS X

Complete the following steps to set up a print server driver on your Macintosh computer.

- 1 Click the **Print Center** icon  located in the Macintosh Dock (a place holding a series of icons/shortcuts at the bottom of the desktop). Proceed to step 6 to continue. If the **Print Center** icon is not in the Macintosh Dock, proceed to the next step.
- 2 On your desktop, double-click the **Macintosh HD** icon to open the **Macintosh HD** window.

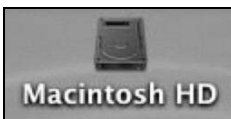

- 3 Double-click the **Applications** folder.

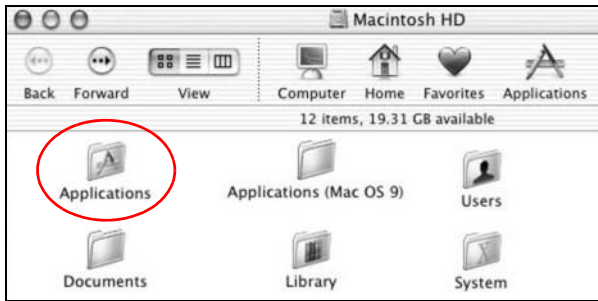

- 4 Double-click the **Utilities** folder.

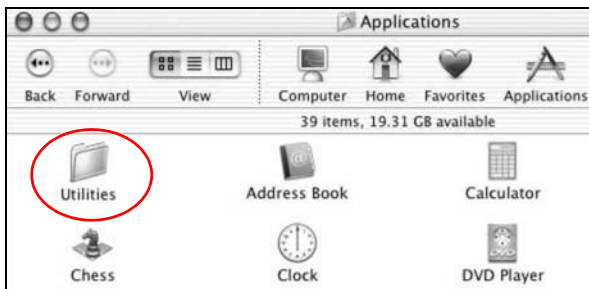

- 5 Double-click the **Print Center** icon.

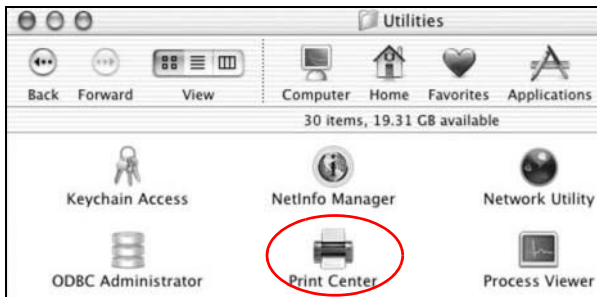

- 6 Click the **Add** icon at the top of the screen.

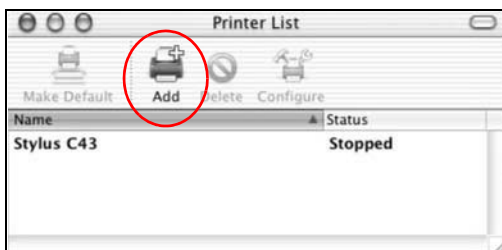

- 7 Set up your printer in the **Printer List** configuration screen. Select **IP Printing** from the drop-down list box.
- 8 In the **Printer's Address** field, type the IP address of your Device.
- 9 Deselect the **Use default queue on server** check box.
- 10 Type **LP1** in the **Queue Name** field.

- 11 Select your **Printer Model** from the drop-down list box. If the printer's model is not listed, select **Generic**.



- 12 Click **Add** to select a printer model, save and close the **Printer List** configuration screen.

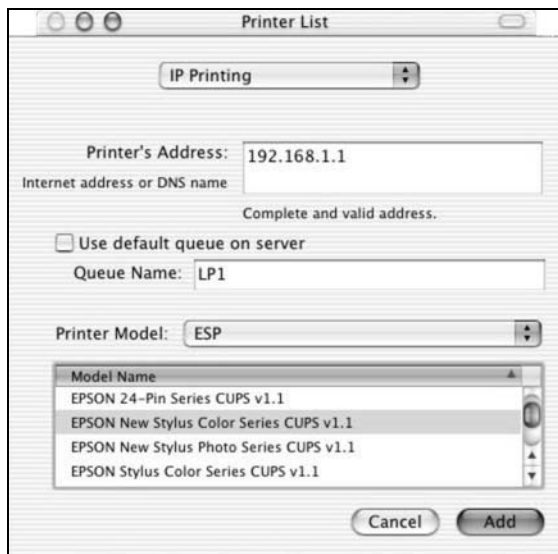

- 13 The **Name LP1 on 192.168.1.1** displays in the **Printer List** field. The default printer **Name** displays in bold type.

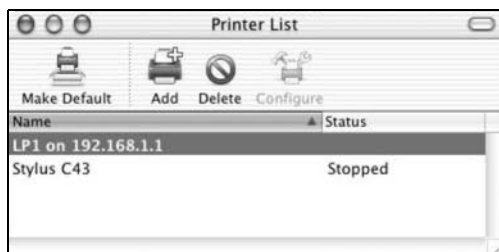

Your Macintosh print server driver setup is complete. You can now use the Device's print server to print from a Macintosh computer.

PART II

Technical Reference

Network Map and Status Screens

5.1 Overview

After you log into the Web Configurator, the **Network Map** screen appears. This shows the network connection status of the Device and clients connected to it.

You can use the **Status** screen to look at the current status of the Device, system resources, and interfaces (LAN, WAN, and WLAN).

5.2 The Network Map Screen

Use this screen to view the network connection status of the device and its clients. A warning message appears if there is a connection problem.

Figure 15 Network Map: Icon View Mode

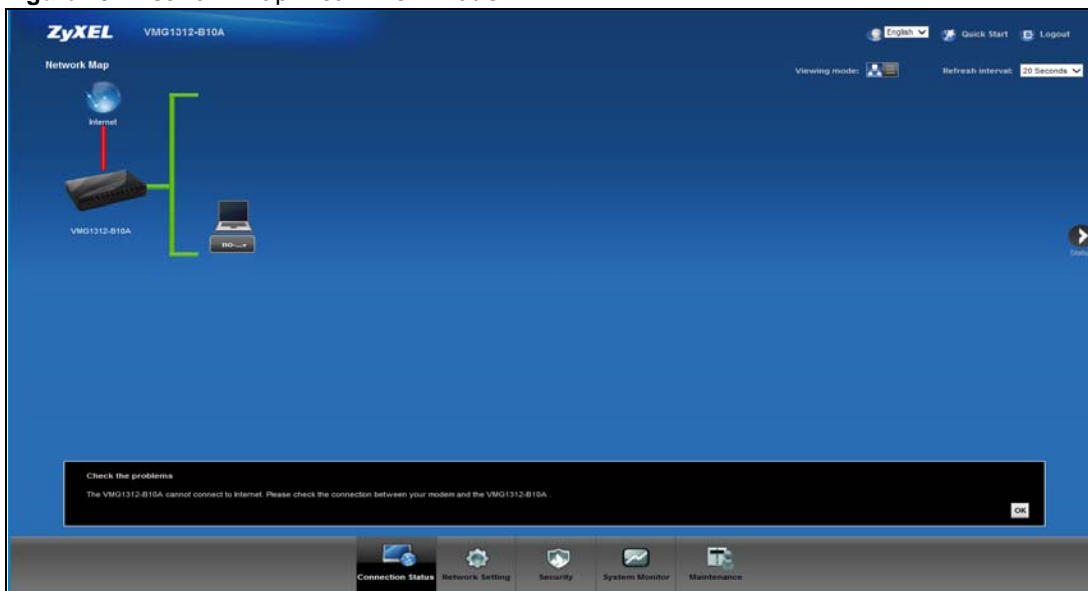

If you want to view information about a client, click the client's name and **Info**. Click the IP address if you want to change it. If you want to change the name or icon of the client, click **Change name/icon**.



If you prefer to view the status in a list, click **List View** in the **Viewing mode** selection box. You can configure how often you want the Device to update this screen in **Refresh interval**.

Figure 16 Network Map: List View Mode

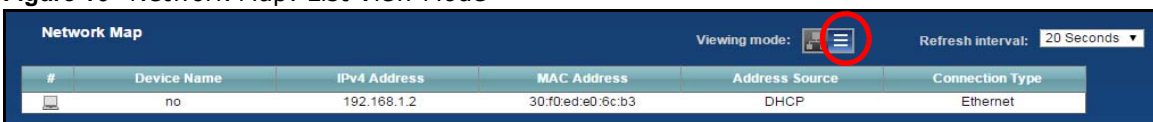

5.3 The Status Screen

Use this screen to view the status of the Device. Click **Status** to open this screen.

Figure 17 Status Screen

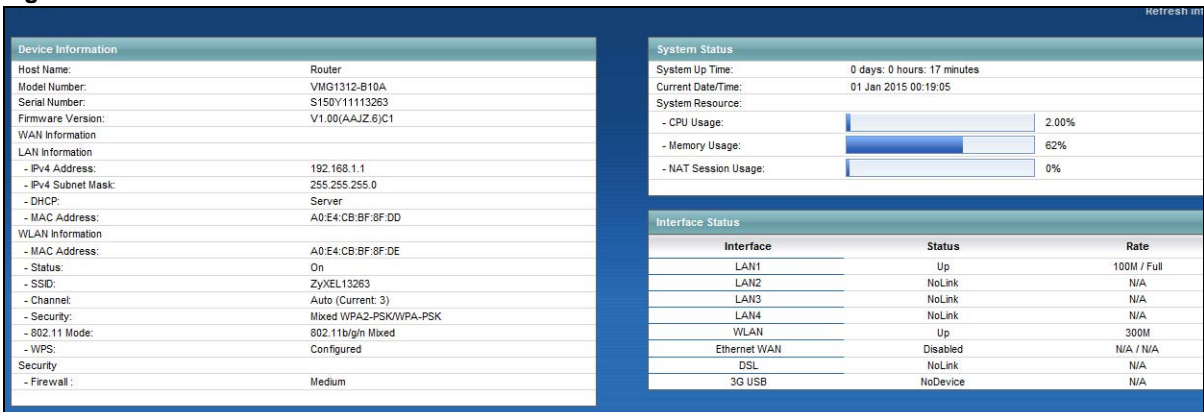

Each field is described in the following table.

Table 5 Status Screen

LABEL	DESCRIPTION
Refresh Interval	Select how often you want the Device to update this screen.
Device Information	
Host Name	This field displays the Device system name. It is used for identification.
Model Number	This shows the model number of your Device.
Serial Number	This shows the unique serial number of your Device.
Firmware Version	This is the current version of the firmware inside the Device.

Table 5 Status Screen (continued)

LABEL	DESCRIPTION
WAN Information (These fields display when you have a WAN connection.)	
WAN Type	This shows whether it's a DSL, Ethernet or 3G WAN connection..
WAN Name	This is the name of the interface.
MAC Address	This shows the WAN Ethernet adapter MAC (Media Access Control) Address of your Device.
IPv4 Address	This field displays the current IP address of the Device in the WAN. Click Release to release your IP address to 0.0.0.0. If you want to renew your IP address, click Renew .
IPv4 Subnet Mask	This field displays the current subnet mask in the WAN.
IPv4 Uptime	This shows how long the Device has had the IP address.
Primary DNS server	This shows the primary DNS server IP address.
Secondary DNS server	This shows the secondary DNS server IP address.
Encapsulation	This field displays the current encapsulation method.
LAN Information	
IPv4 Address	This is the current IP address of the Device in the LAN.
IPv4 Subnet Mask	This is the current subnet mask in the LAN.
DHCP	This field displays what DHCP services the Device is providing to the LAN. Choices are: Server - The Device is a DHCP server in the LAN. It assigns IP addresses to other computers in the LAN. Relay - The Device acts as a surrogate DHCP server and relays DHCP requests and responses between the remote server and the clients. None - The Device is not providing any DHCP services to the LAN.
MAC Address	This shows the LAN Ethernet adapter MAC (Media Access Control) Address of your Device.
WLAN Information	
MAC Address	This shows the wireless adapter MAC (Media Access Control) Address of the wireless interface.
Status	This displays whether the WLAN is activated.
SSID	This is the descriptive name used to identify the Device in a wireless LAN.
Channel	This is the channel number used by the wireless interface now.
Security	This displays the type of security mode the wireless interface is using in the wireless LAN.
802.11 Mode	This displays the type of 802.11 mode the wireless interface is using in the wireless LAN.
WPS	This displays whether WPS is activated on the wireless interface.
Security	
Firewall	This displays the firewall's current security level.
System Status	
System Up Time	This field displays how long the Device has been running since it last started up. The Device starts up when you plug it in, when you restart it (Maintenance > Reboot), or when you reset it.
Current Date/ Time	This field displays the current date and time in the Device. You can change this in Maintenance > Time Setting .
System Resource	

Table 5 Status Screen (continued)

LABEL	DESCRIPTION
CPU Usage	This field displays what percentage of the Device's processing ability is currently used. When this percentage is close to 100%, the Device is running at full load, and the throughput is not going to improve anymore. If you want some applications to have more throughput, you should turn off other applications (for example, using QoS; see Chapter 10 on page 148).
Memory Usage	This field displays what percentage of the Device's memory is currently used. Usually, this percentage should not increase much. If memory usage does get close to 100%, the Device is probably becoming unstable, and you should restart the device. See Section 39.2 on page 270 , or turn off the device (unplug the power) for a few seconds.
NAT Session Usage	This field displays what percentage of the Device supported NAT sessions are currently being used.
Interface Status	
Interface	This column displays each interface the Device has.
Status	<p>This field indicates the interface's use status.</p> <p>For the LAN and Ethernet WAN interfaces, this field displays Up when using the interface and NoLink when not using the interface.</p> <p>For a WLAN interface, this field displays the enabled (Active) or disabled (InActive) state of the interface.</p> <p>For the DSL interface, this field displays Down (line down), Up (line up or connected), Drop (dropping a call) if you're using PPPoE encapsulation, and NoLink when not using the interface.</p> <p>For the 3G USB interface, this field displays Up when using the interface and NoDevice when no device is detected in any USB slot.</p>
Rate	<p>For the Ethernet WAN and LAN interface, this displays the port speed and duplex setting.</p> <p>For the DSL interface, it displays the downstream and upstream transmission rate.</p> <p>For the WLAN interface, it displays the maximum transmission rate or N/A with WLAN disabled.</p> <p>For the 3G USB interface, this field displays Up when a 3G USB device is installed in a USB slot and NoDevice when no device is detected in any USB slot.</p>

Broadband

6.1 Overview

This chapter discusses the Device's **Broadband** screens. Use these screens to configure your Device for Internet access.

A WAN (Wide Area Network) connection is an outside connection to another network or the Internet. It connects your private networks, such as a LAN (Local Area Network) and other networks, so that a computer in one location can communicate with computers in other locations.

Figure 18 LAN and WAN

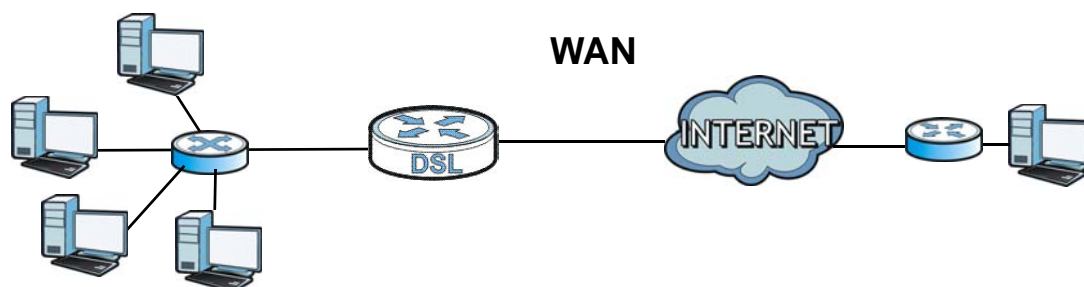

6.1.1 What You Can Do in this Chapter

- Use the **Broadband** screen to view, remove or add a WAN interface. You can also configure the WAN settings on the Device for Internet access ([Section 6.2 on page 70](#)).
- Use the **3G Backup** screen to configure 3G WAN connection ([Section 6.3 on page 79](#)).
- Use the **Advanced** screen to enable or disable PTM over ADSL, Annex M/Annex J, and DSL PhyR functions ([Section 6.4 on page 83](#)).
- Use the **802.1x** screen to view and configure the IEEE 802.1X settings on the Device ([Section 6.5 on page 86](#)).
- Use the **Ethernet WAN** screen to convert LAN port number four as a WAN port or restore the WAN to a LAN port ([Section 6.6 on page 87](#)). This is for Ethernet connection.

Table 6 WAN Setup Overview

LAYER-2 INTERFACE		INTERNET CONNECTION		
CONNECTION	DSL LINK TYPE	MODE	ENCAPSULATION	CONNECTION SETTINGS
ADSL/VDSL over PTM	N/A	Routing	PPPoE	PPP information, IPv4/IPv6 IP address, routing feature, DNS server, VLAN, QoS, and MTU
			IPoE	IPv4/IPv6 IP address, routing feature, DNS server, VLAN, QoS, and MTU
		Bridge	N/A	VLAN and QoS
ADSL over ATM	EoA	Routing	PPPoE/PPPoA	ATM PVC configuration, PPP information, IPv4/IPv6 IP address, routing feature, DNS server, VLAN, QoS, and MTU
			IPoE/IPoA	ATM PVC configuration, IPv4/IPv6 IP address, routing feature, DNS server, VLAN, QoS, and MTU
		Bridge	N/A	ATM PVC configuration, and QoS
Ethernet	N/A	Routing	PPPoE	PPP user name and password, WAN IPv4/IPv6 IP address, routing feature, DNS server, VLAN, QoS, and MTU
			IPoE	WAN IPv4/IPv6 IP address, NAT, DNS server and routing feature
		Bridge	N/A	VLAN and QoS

6.1.2 What You Need to Know

The following terms and concepts may help as you read this chapter.

WAN IP Address

The WAN IP address is an IP address for the Device, which makes it accessible from an outside network. It is used by the Device to communicate with other devices in other networks. It can be static (fixed) or dynamically assigned by the ISP each time the Device tries to access the Internet.

If your ISP assigns you a static WAN IP address, they should also assign you the subnet mask and DNS server IP address(es).

ATM

Asynchronous Transfer Mode (ATM) is a WAN networking technology that provides high-speed data transfer. ATM uses fixed-size packets of information called cells. With ATM, a high QoS (Quality of Service) can be guaranteed. ATM uses a connection-oriented model and establishes a virtual circuit (VC) between Finding Out More

PTM

Packet Transfer Mode (PTM) is packet-oriented and supported by the VDSL2 standard. In PTM, packets are encapsulated directly in the High-level Data Link Control (HDLC) frames. It is designed to provide a low-overhead, transparent way of transporting packets over DSL links, as an alternative to ATM.

IPv6 Introduction

IPv6 (Internet Protocol version 6), is designed to enhance IP address size and features. The increase in IPv6 address size to 128 bits (from the 32-bit IPv4 address) allows up to 3.4×10^{38} IP addresses. The Device can use IPv4/IPv6 dual stack to connect to IPv4 and IPv6 networks, and supports IPv6 rapid deployment (6RD).

IPv6 Addressing

The 128-bit IPv6 address is written as eight 16-bit hexadecimal blocks separated by colons (:). This is an example IPv6 address `2001:0db8:1a2b:0015:0000:0000:1a2f:0000`.

IPv6 addresses can be abbreviated in two ways:

- Leading zeros in a block can be omitted. So `2001:0db8:1a2b:0015:0000:0000:1a2f:0000` can be written as `2001:db8:1a2b:15:0:0:1a2f:0`.
- Any number of consecutive blocks of zeros can be replaced by a double colon. A double colon can only appear once in an IPv6 address. So `2001:0db8:0000:0000:1a2f:0000:0000:0015` can be written as `2001:0db8::1a2f:0000:0000:0015`, `2001:0db8:0000:0000:1a2f::0015`, `2001:db8::1a2f:0:0:15` or `2001:db8:0:0:1a2f::15`.

IPv6 Prefix and Prefix Length

Similar to an IPv4 subnet mask, IPv6 uses an address prefix to represent the network address. An IPv6 prefix length specifies how many most significant bits (start from the left) in the address compose the network address. The prefix length is written as "/x" where x is a number. For example,

```
2001:db8:1a2b:15::1a2f:0/32
```

means that the first 32 bits (`2001:db8`) is the subnet prefix.

IPv6 Subnet Masking

Both an IPv6 address and IPv6 subnet mask compose of 128-bit binary digits, which are divided into eight 16-bit blocks and written in hexadecimal notation. Hexadecimal uses four bits for each character (1 ~ 10, A ~ F). Each block's 16 bits are then represented by four hexadecimal characters. For example, `FFFF:FFFF:FFFF:FFFF:FC00:0000:0000:0000`.

IPv6 Rapid Deployment

Use IPv6 Rapid Deployment (6rd) when the local network uses IPv6 and the ISP has an IPv4 network. When the Device has an IPv4 WAN address and you set **IPv6/IPv4 Mode** to **IPv4 Only**, you can enable 6rd to encapsulate IPv6 packets in IPv4 packets to cross the ISP's IPv4 network.

The Device generates a global IPv6 prefix from its IPv4 WAN address and tunnels IPv6 traffic to the ISP's Border Relay router (BR in the figure) to connect to the native IPv6 Internet. The local network can also use IPv4 services. The Device uses its configured IPv4 WAN IP to route IPv4 traffic to the IPv4 Internet.

Figure 19 IPv6 Rapid Deployment

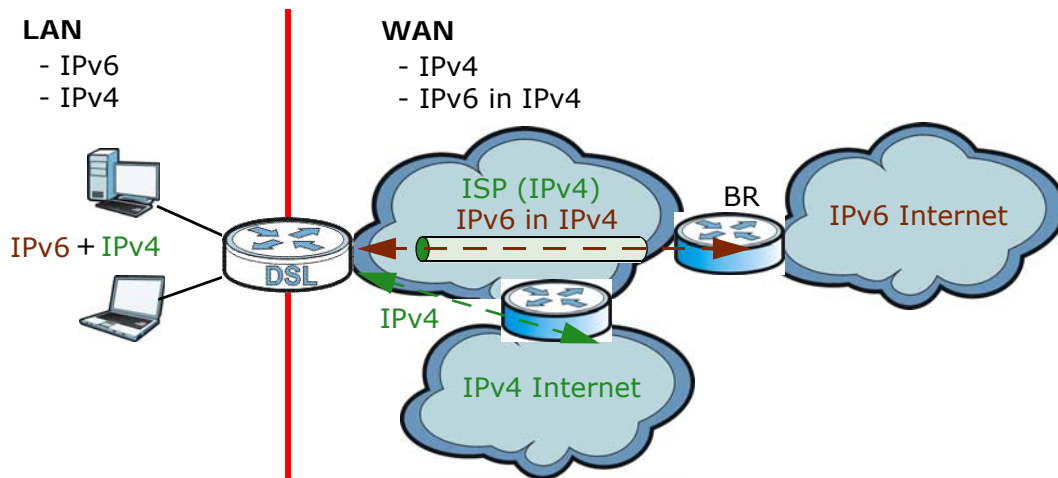

Dual Stack Lite

Use Dual Stack Lite when local network computers use IPv4 and the ISP has an IPv6 network. When the Device has an IPv6 WAN address and you set **IPv6/IPv4 Mode** to **IPv6 Only**, you can enable Dual Stack Lite to use IPv4 computers and services.

The Device tunnels IPv4 packets inside IPv6 encapsulation packets to the ISP's Address Family Transition Router (AFTR in the graphic) to connect to the IPv4 Internet. The local network can also use IPv6 services. The Device uses its configured IPv6 WAN IP to route IPv6 traffic to the IPv6 Internet.

Figure 20 Dual Stack Lite

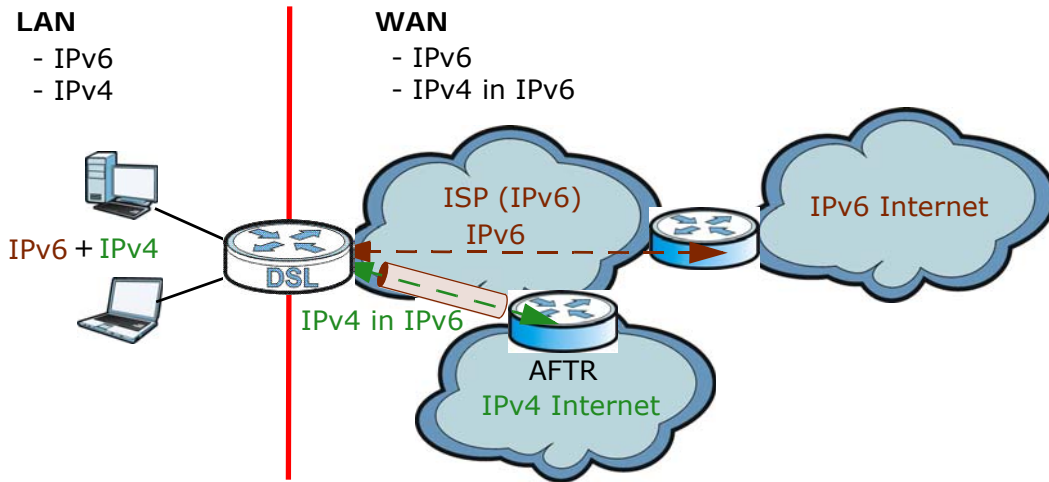

6.1.3 Before You Begin

You need to know your Internet access settings such as encapsulation and WAN IP address. Get this information from your ISP.

6.2 The Broadband Screen

Use this screen to change your Device's Internet access settings. Click **Network Setting > Broadband** from the menu. The summary table shows you the configured WAN services (connections) on the Device.

Figure 21 Network Setting > Broadband

Broadband												
3G Backup Advanced 802.1x Ethernet WAN												
You can configure the Internet settings of this device. Correct configurations build successful Internet connection.												
Add New WAN Interface												
#	Name	Type	Mode	Encaps...	802.1p	802.1q	IGMP Proxy	NAT	Default Gateway	IPv6	MLD Proxy	Modify
1	ADSL	ATM	Routing	IPoE	N/A	N/A	Y	Y	Y	Y	N	
2	VDSL	PTM	Routing	IPoE	N/A	N/A	Y	Y	Y	Y	N	
3	ETHWAN	Ethernet	Routing	IPoE	N/A	N/A	Y	Y	Y	Y	N	

The following table describes the labels in this screen.

Table 7 Network Setting > Broadband

LABEL	DESCRIPTION
Add New WAN Interface	Click this button to create a new connection.
#	This is the index number of the entry.
Name	This is the service name of the connection.
Type	This shows whether it is an ATM, Ethernet or a PTM connection.

Table 7 Network Setting > Broadband (continued)

LABEL	DESCRIPTION
Mode	This shows whether the connection is in routing or bridge mode.
Encapsulation	This is the method of encapsulation used by this connection.
802.1p	This indicates the 802.1p priority level assigned to traffic sent through this connection. This displays N/A when there is no priority level assigned.
802.1q	This indicates the VLAN ID number assigned to traffic sent through this connection. This displays N/A when there is no VLAN ID number assigned.
IGMP Proxy	This shows whether the Device act as an IGMP proxy on this connection.
NAT	This shows whether NAT is activated or not for this connection.
Default Gateway	This shows whether the Device use the WAN interface of this connection as the system default gateway.
IPv6	This shows whether IPv6 is activated or not for this connection. IPv6 is not available when the connection uses the bridging service.
MLD Proxy	This shows whether Multicast Listener Discovery (MLD) is activated or not for this connection. MLD is not available when the connection uses the bridging service.
Modify	Click the Edit icon to configure the WAN connection. Click the Delete icon to remove the WAN connection.

6.2.1 Add/Edit Internet Connection

Click **Add New WAN Interface** in the **Broadband** screen or the **Edit** icon next to an existing WAN interface to configure a WAN connection. The screen varies depending on the interface type, mode, encapsulation, and IPv6/IPv4 mode you select.

6.2.1.1 Routing Mode

Use **Routing** mode if your ISP give you one IP address only and you want multiple computers to share an Internet account.

The following example screen displays when you select the **ADSL/VDSL over ATM** connection type, **Routing** mode, and **PPPoE** encapsulation. The screen varies when you select other interface type, encapsulation, and IPv6/IPv4 mode.

Figure 22 Network Setting > Broadband > Add New WAN Interface/Edit (Routing Mode)

WAN Configuration

General

Active:

Name:

Type: ADSL/VDSL over PTM

Mode: Routing

Encapsulation: PPPoE

IPv6/IPv4 Mode: IPv4 Only

PPP Information

PPP User Name:

PPP Password: password unmask

PPP Trigger Type: Auto Connect Connect on Demand Manual

Authentication Method: AUTO

Idle Timeout [minutes]: 5

PPPoE Service Name:

PPPoE Passthrough:

IP Address

Obtain an IP Address Automatically

Static IP Address

IP Address: 0.0.0.0

Subnet Mask: 0.0.0.0

Gateway IP Address: 0.0.0.0

Routing Feature

NAT Enable:

IGMP Proxy Enable:

Apply as Default Gateway:

DNS server

DNS: Dynamic Static

DNS Server 1:

DNS Server 2:

Tunnel

Enable 6RD: Enable Disable

6RD Type: DHCP Static

IPv4 Mask Length:

6RD Border Relay Server IP:

6RD IPv6 Prefix:

VLAN

Active:

802.1p: 0

802.1q: (0-4094)

QoS

Rate Limit: (kbps)

WAN Outgoing Default Tag: Enable Disable

DSCP: (0-63)

MTU

MTU Size: 1492 MTU [68-1492]

Apply Cancel

The following table describes the labels in this screen.

Table 8 Network Setting > Broadband > Add New WAN Interface/Edit (Routing Mode)

LABEL	DESCRIPTION
General	
Active	Select this to enable the interface.
Name	Specify a descriptive name for this connection.
Type	Select whether it is an ADSL/VDSL over PTM, ADSL over ATM connection or Ethernet.
Mode	Select Routing if your ISP give you one IP address only and you want multiple computers to share an Internet account.
Encapsulation	Select the method of encapsulation used by your ISP from the drop-down list box. This option is available only when you select Routing in the Mode field. The choices depend on the connection type you selected. If your connection type is ADSL/VDSL over PTM , the choices are PPPoE and IPoE . If your connection type is ADSL over ATM , the choices are PPPoE , PPPoA , IPoE and IPoA .
IPv6/IPv4 Mode	Select IPv4 Only if you want the Device to run IPv4 only. Select IPv6/IPv4 DualStack to allow the Device to run IPv4 and IPv6 at the same time. Select IPv6 Only if you want the Device to run IPv6 only.
ATM PVC Configuration (These fields appear when the Type is set to ADSL over ATM .)	
VPI	The valid range for the VPI is 0 to 255. Enter the VPI assigned to you.
VCI	The valid range for the VCI is 32 to 65535 (0 to 31 is reserved for local management of ATM traffic). Enter the VCI assigned to you.
DSL Link Type	The choices in this field change according to the Encapsulation method chosen above. This field is not editable. PPPoA and IPoA encapsulation use the same named DSL Link Type . Ethernet-over-ATM (EoA) is used for PPPoE , and IPoE encapsulation. EoA a protocol for data transfer between Ethernet LAN and WAN over the ATM protocol. It creates a bridged connection between the Device and the ISP. It uses an Ethernet header in the packet, so that you can have multiple services/connections over one PVC. You can set each connection to have its own MAC address or all connections share one MAC address but use different VLAN IDs for different services. EoA supports ENET ENCAP (IPoE), PPPoE and RFC1483/2684 bridging encapsulation methods. PPPoA (PPP over ATM) allows just one PPPoA connection over a PVC. IPoA (IP over ATM) allows just one RFC 1483 routing connection over a PVC.
Encapsulation Mode	Select the method of multiplexing used by your ISP from the drop-down list box. Choices are: <ul style="list-style-type: none"> • LLC/SNAP-BRIDGING: In LCC encapsulation, bridged PDUs are encapsulated by identifying the type of the bridged media in the SNAP header. This is available only when you select IPoE or PPPoE in the Select DSL Link Type field. • VC/MUX: In VC multiplexing, each protocol is carried on a single ATM virtual circuit (VC). To transport multiple protocols, the Device needs separate VCs. There is a binding between a VC and the type of the network protocol carried on the VC. This reduces payload overhead since there is no need to carry protocol information in each Protocol Data Unit (PDU) payload. • LLC/ENCAPSULATION: More than one protocol can be carried over the same VC. This is available only when you select PPPoA in the Encapsulation field. • LLC/SNAP-ROUTING: In LCC encapsulation, an IEEE 802.2 Logical Link Control (LLC) header is prefixed to each routed PDU to identify the PDUs. The LCC header can be followed by an IEEE 802.1a SubNetwork Attachment Point (SNAP) header. This is available only when you select IPoA in the Encapsulation field.

Table 8 Network Setting > Broadband > Add New WAN Interface/Edit (Routing Mode) (continued)

LABEL	DESCRIPTION
Service Category	<p>Select UBR Without PCR or UBR With PCR for applications that are non-time sensitive, such as e-mail.</p> <p>Select CBR (Continuous Bit Rate) to specify fixed (always-on) bandwidth for voice or data traffic.</p> <p>Select Non Realtime VBR (non real-time Variable Bit Rate) for connections that do not require closely controlled delay and delay variation.</p> <p>Select Realtime VBR (real-time Variable Bit Rate) for applications with bursty connections that require closely controlled delay and delay variation.</p>
PPP Information (This is available only when you select PPPoE or PPPoA in the Mode field.)	
PPP User Name	Enter the user name exactly as your ISP assigned. If assigned a name in the form user@domain where domain identifies a service name, then enter both components exactly as given.
PPP Password	Enter the password associated with the user name above. Select password unmask to show your entered password in plain text.
PPP Trigger Type	<p>Select when to have the Device establish the PPP connection.</p> <p>Auto Connect - select this to not let the connection time out.</p> <p>Connect on Demand - select this to automatically bring up the connection when the Device receives packets destined for the Internet.</p> <p>Manual - select this if you want to manually trigger the connection up.</p>
Authentication Method	<p>Select an authentication protocol for outgoing connection requests through this WAN interface.</p> <p>PAP - Password Authentication Protocol (PAP) authentication sends user name and password in clear text without using encryption. Select this if your Device accepts PAP only.</p> <p>CHAP - Challenge Handshake Authentication Protocol (CHAP) provides authentication through a shared secret key and uses a three way handshake. Select this if your Device accepts CHAP only.</p> <p>MSCHAP - Microsoft CHAP provides authentication through a shared secret key and uses a three way handshake. It provides improved usability with Microsoft products. Select this if your Device accepts MSCHAP only.</p> <p>AUTO - Select this if your Device accepts either PAP, CHAP, or MSCHAP authentication method.</p>
Idle Timeout	<p>This value specifies the time in minutes that elapses before the router automatically disconnects from the PPPoE server.</p> <p>This field is not configurable if you select Auto Connect in the PPP Trigger Type field.</p>
PPPoE Service Name	Enter the name of your PPPoE service here.
PPPoE Passthrough	<p>This field is available when you select PPPoE encapsulation.</p> <p>In addition to the Device's built-in PPPoE client, you can enable PPPoE pass through to allow up to ten hosts on the LAN to use PPPoE client software on their computers to connect to the ISP via the Device. Each host can have a separate account and a public WAN IP address.</p> <p>PPPoE pass through is an alternative to NAT for application where NAT is not appropriate.</p> <p>Disable PPPoE pass through if you do not need to allow hosts on the LAN to use PPPoE client software on their computers to connect to the ISP.</p>
IP Address (This is available only when you select IPv4 Only or IPv6/IPv4 DualStack in the IPv6/IPv4 Mode field.)	

Table 8 Network Setting > Broadband > Add New WAN Interface/Edit (Routing Mode) (continued)

LABEL	DESCRIPTION
Obtain an IP Address Automatically	A static IP address is a fixed IP that your ISP gives you. A dynamic IP address is not fixed; the ISP assigns you a different one each time you connect to the Internet. Select this if you have a dynamic IP address.
DHCP option 60/ Vendor ID	This field displays when editing an existing WAN interface. Type the class vendor ID you want the Device to add in the DHCP Discovery packets that go to the DHCP server.
DHCP option 61 IAD	This field displays when editing an existing WAN interface. Type the Identity Association Identifier (IAD) you want the Device to add in the DHCP Discovery packets that go to the DHCP server.
DHCP option 61 DUID	This field displays when editing an existing WAN interface. Type the DHCP Unique Identifier (DUID) you want the Device to add in the DHCP Discovery packets that go to the DHCP server.
DHCP option 43 Enable	This field displays when editing an existing WAN interface. Type the vendor specific information you want the Device to add in the DHCP Offer packets. The information is used, for example, for configuring an ACS's (Auto Configuration Server) URL.
Static IP Address	Select this option If the ISP assigned a fixed IP address.
IP Address	Enter the static IP address provided by your ISP.
Subnet Mask	Enter the subnet mask provided by your ISP.
Gateway IP Address	Enter the gateway IP address provided by your ISP.
Routing Feature (This is available only when you select IPv4 Only or IPv6/IPv4 DualStack in the IPv6/IPv4 Mode field.)	
NAT Enable	Select this option to activate NAT on this connection.
Fullcone NAT Enable	Select this option to enable full cone NAT on this connection. This field is available only when you activate NAT. In full cone NAT, the Device maps all outgoing packets from an internal IP address and port to a single IP address and port on the external network. The Device also maps packets coming to that external IP address and port to the internal IP address and port.
IGMP Proxy Enable	Internet Group Multicast Protocol (IGMP) is a network-layer protocol used to establish membership in a Multicast group - it is not used to carry user data. Select this option to have the Device act as an IGMP proxy on this connection. This allows the Device to get subscribing information and maintain a joined member list for each multicast group. It can reduce multicast traffic significantly.
Apply as Default Gateway	Select this option to have the Device use the WAN interface of this connection as the system default gateway.
DNS Server (This is available only when you select IPv4 Only or IPv6/IPv4 DualStack in the IPv6/IPv4 Mode field.)	
DNS	Select Obtain DNS Info Automatically if you want the Device to use the DNS server addresses assigned by your ISP. Select Use Following Static DNS Address if you want the Device to use the DNS server addresses you configure manually.
DNS Server1	Enter the first DNS server address assigned by the ISP.
DNS Server 2	Enter the second DNS server address assigned by the ISP.

Table 8 Network Setting > Broadband > Add New WAN Interface/Edit (Routing Mode) (continued)

LABEL	DESCRIPTION
	<p>Tunnel (This is available only when you select IPv4 Only or IPv6 Only in the IPv6/IPv4 Mode field.)</p> <p>The DS-Lite (Dual Stack Lite) fields display when you set the IPv6/IPv4 Mode field to IPv6 Only. Enable Dual Stack Lite to let local computers use IPv4 through an ISP's IPv6 network. See Dual Stack Lite on page 69 for more information.</p> <p>The 6RD (IPv6 rapid deployment) fields display when you set the IPv6/IPv4 Mode field to IPv4 Only. See IPv6 Rapid Deployment on page 69 for more information.</p>
Enable DS-Lite	This is available only when you select IPv6 Only in the IPv6/IPv4 Mode field. Select Enable to let local computers use IPv4 through an ISP's IPv6 network.
DS-Lite Relay Server IP	Specify the transition router's IPv6 address.
Enable 6RD	This is available only when you select IPv4 Only in the IPv6/IPv4 Mode field. Select Enable to tunnel IPv6 traffic from the local network through the ISP's IPv4 network.
6RD Type	Select Static if you have the IPv4 address of the relay server, otherwise select DHCP to have the Device detect it automatically through DHCP.
IPv4 Mask Length	Enter the subnet mask number (1~32) for the IPv4 network.
6RD Border Relay Server IP	When you set the 6RD Type to Static , specify the relay server's IPv4 address in this field.
6RD IPv6 Prefix	Enter an IPv6 prefix for tunneling IPv6 traffic to the ISP's border relay router and connecting to the native IPv6 Internet.
IPv6 Address (This is available only when you select IPv6/IPv4 DualStack or IPv6 Only in the IPv6/IPv4 Mode field.)	
IPv6 Address	<p>Select Automatic if you want to have the Device use the IPv6 prefix from the connected router's Router Advertisement (RA) to generate an IPv6 address.</p> <ul style="list-style-type: none"> Select Get IPv6 Address From DHCPv6 Server (IA_NA) if you want to obtain an IPv6 address from a DHCPv6 server. The IP address assigned by a DHCPv6 server has priority over the IP address automatically generated by the Device using the IPv6 prefix from an RA. This option is available only when you choose to get your IPv6 address automatically. Select Prefix Delegation (IA_PD) to use DHCP PD (Prefix Delegation) which enables the Device to pass the IPv6 prefix information to its LAN hosts. The hosts can then use the prefix to generate their IPv6 addresses. <p>Select Static if you have a fixed IPv6 address assigned by your ISP.</p> <p>Select None to not assign any IPv6 address to this WAN connection.</p>
Prefix Length	Enter the address prefix length to specify how many most significant bits in an IPv6 address compose the network address.
Next Hop	Enter the IP address of the next-hop gateway. The gateway is a router or switch on the same segment as your Device's interface(s). The gateway helps forward packets to their destinations.
IPv6 Routing Feature (This is available only when you select IPv6/IPv4 DualStack or IPv6 Only in the IPv6/IPv4 Mode field. You can enable IPv6 routing features in the following section.)	
MLD Proxy Enable	Select this checkbox to have the Device act as an MLD proxy on this connection. This allows the Device to get subscription information and maintain a joined member list for each multicast group. It can reduce multicast traffic significantly.
Apply as Default Gateway	Select this option to have the Device use the WAN interface of this connection as the system default gateway.
IPv6 DNS Server	Configure the IPv6 DNS server in the following section.

Table 8 Network Setting > Broadband > Add New WAN Interface/Edit (Routing Mode) (continued)

LABEL	DESCRIPTION
IPv6 DNS	Select Dynamic to have the Device get the IPv6 DNS server addresses from the ISP automatically. Select Static to have the Device use the IPv6 DNS server addresses you configure manually.
IPv6 DNS Server 1	Enter the first IPv6 DNS server address assigned by the ISP.
IPv6 DNS Server 2	Enter the second IPv6 DNS server address assigned by the ISP.
VLAN (These fields appear when the Type is set to ADSL/VDSL over PTM.)	
Active	Select this to enable VLAN on this WAN interface.
802.1p	IEEE 802.1p defines up to 8 separate traffic types by inserting a tag into a MAC-layer frame that contains bits to define class of service. Select the IEEE 802.1p priority level (from 0 to 7) to add to traffic through this connection. The greater the number, the higher the priority level.
802.1q	Type the VLAN ID number (from 1 to 4094) for traffic through this connection.
QoS	
Rate Limit	Enter the rate limit for the connection. This is the maximum transmission rate allowed for traffic on this connection.
WAN Outgoing Default Tag	Select Enable and enter a DSCP (DiffServ Code Point) value to have the Device add it in the packets sent by this WAN interface.
802.1p	This field displays if you activate VLAN for this WAN interface. Enter a priority level (from 0 to 7) to have the Device add it to traffic through this connection.
DSCP	If you enable Select WAN Outgoing Default Tag , enter a DSCP (DiffServ Code Point) value to have the Device add it in the packets sent by this WAN interface.
MTU	
MTU Size	Enter the MTU (Maximum Transfer Unit) size for this traffic.
Bridging and Routing in the same WAN	Use this feature to bridge a LAN port(s) with the WAN interface. Traffic to/from LAN ports not in the bridge is routed from the WAN interface. ADSL use same VPI/VCI in Bridge and Route modes. VDSL use same VLAN in Bridge and Route modes.
Enable Concurrent WAN	Enable this if you want to use the same VPI/VCI settings in different WAN interfaces. Select this and then choose the ports to bridge with the WAN interface. \ <ul style="list-style-type: none"> • ADSL concurrent WAN uses the same VCI/PVI in both routing and bridge modes. • VDSL concurrent WAN uses same VLAN in both routing and bridge mode.
Apply	Click Apply to save your changes back to the Device.
Cancel	Click Cancel to exit this screen without saving.

6.2.1.2 Bridge Mode

Click the **Add new WAN Interface** in the **Network Setting > Broadband** screen or the **Edit** icon next to the connection you want to configure. Select **Bridge** as the encapsulation mode. The screen varies depending on the interface type you select.

If you select **ADSL/VDSL over PTM** as the interface type, the following screen appears.

Figure 23 Network Setting > Broadband > Add New WAN Interface/Edit (Bridge Mode)

The following table describes the fields in this screen.

Table 9 Network Setting > Broadband > Add New WAN Interface/Edit (Bridge Mode)

LABEL	DESCRIPTION
General	
Active	Select this to enable the interface.
Name	Enter a service name of the connection.
Type	Select ADSL/VDSL over PTM as the interface that you want to configure. The Device uses the VDSL technology for data transmission over the DSL port.
Mode	Select Bridge when your ISP provides you more than one IP address and you want the connected computers to get individual IP address from ISP's DHCP server directly. If you select Bridge , you cannot use routing functions, such as QoS, Firewall, DHCP server and NAT on traffic from the selected LAN port(s).
VLAN	
Active	Select this to enable VLAN on this WAN interface.
802.1p	IEEE 802.1p defines up to 8 separate traffic types by inserting a tag into a MAC-layer frame that contains bits to define class of service. Select the IEEE 802.1p priority level (from 0 to 7) to add to traffic through this connection. The greater the number, the higher the priority level.
802.1q	Type the VLAN ID number (from 0 to 4094) for traffic through this connection.
QoS	
Rate Limit	Enter the rate limit for the connection. This is the maximum transmission rate allowed for traffic on this connection.
Apply	Click Apply to save your changes.
Cancel	Click Cancel to exit this screen without saving.

6.3 The 3G Backup Screen

The USB ports (at the left side panel of the Device) allow you to attach a 3G dongle to wirelessly connect to a 3G network for Internet access. You can have the Device use the 3G WAN connection as a backup. Disconnect the DSL and Ethernet WAN ports to use the 3G dongle as your primary WAN connection. The Device automatically uses a wired WAN connection when available.

Note: This Device supports connecting one 3G dongle at a time.

Figure 24 Internet Access Application: 3G WAN

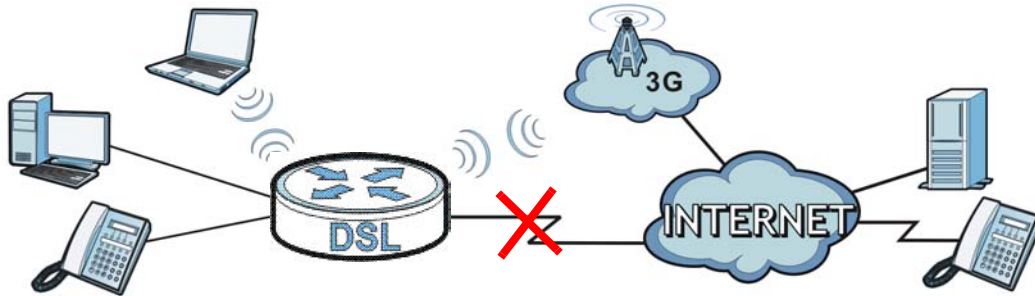

Use this screen to configure your 3G settings. Click **Network Setting > Broadband > 3G Backup**.

Note: The actual data rate you obtain varies depending the 3G card you use, the signal strength to the service provider’s base station, and so on.

Figure 25 Network Setting > Broadband > 3G Backup

The following table describes the labels in this screen.

Table 10 Network Setting > Broadband > 3G Backup

LABEL	DESCRIPTION
General	
3G Backup	Select Enable to have the Device use the 3G connection as your WAN or a backup when the wired WAN connection fails.
Ping Check	Select Enable if you want the Device to ping check the connection status of your WAN. You can configure the frequency of the ping check and number of consecutive failures before triggering 3G backup.
Check Cycle	Enter the frequency of the ping check in this field.
Consecutive PING Fail	Enter how many consecutive failures are required before 3G backup is triggered.
Ping Default Gateway	Select this to have the Device ping the WAN interface’s default gateway IP address.
Ping the Host	Select this to have the Device ping the particular host name or IP address you typed in this field.
3G Connection Settings	
Card description	This field displays the manufacturer and model name of your 3G card if you inserted one in the Device. Otherwise, it displays N/A .

Table 10 Network Setting > Broadband > 3G Backup (continued)

LABEL	DESCRIPTION
Username	Type the user name (of up to 64 ASCII printable characters) given to you by your service provider.
Password	Type the password (of up to 64 ASCII printable characters) associated with the user name above.
PIN	<p>A PIN (Personal Identification Number) code is a key to a 3G card. Without the PIN code, you cannot use the 3G card.</p> <p>If your ISP enabled PIN code authentication, enter the 4-digit PIN code (0000 for example) provided by your ISP. If you enter the PIN code incorrectly, the 3G card may be blocked by your ISP and you cannot use the account to access the Internet.</p> <p>If your ISP disabled PIN code authentication, leave this field blank.</p>
Dial string	<p>Enter the phone number (dial string) used to dial up a connection to your service provider's base station. Your ISP should provide the phone number.</p> <p>For example, *99# is the dial string to establish a GPRS or 3G connection in Taiwan.</p>
APN	<p>Enter the APN (Access Point Name) provided by your service provider. Connections with different APNs may provide different services (such as Internet access or MMS (Multi-Media Messaging Service)) and charge method.</p> <p>You can enter up to 32 ASCII printable characters. Spaces are allowed.</p>
Connection	<p>Select Nailed UP if you do not want the connection to time out.</p> <p>Select on Demand if you do not want the connection up all the time and specify an idle time-out in the Max Idle Timeout field.</p>
Max Idle Timeout	This value specifies the time in minutes that elapses before the Device automatically disconnects from the ISP.
Obtain an IP Address Automatically	Select this option if your ISP did not assign you a fixed IP address.
Use the following static IP address	Select this option if the ISP assigned a fixed IP address.
IP Address	Enter your WAN IP address in this field if you selected Use the following static IP address .
Obtain DNS info dynamically	Select this to have the Device get the DNS server addresses from the ISP automatically.
Use the following static DNS IP address	Select this to have the Device use the DNS server addresses you configure manually.
Primary DNS server	Enter the first DNS server address assigned by the ISP.
Secondary DNS server	Enter the second DNS server address assigned by the ISP.
Enable Email Notification	Select this to enable the e-mail notification function. The Device will e-mail you a notification when the 3G connection is up.
Mail Server	<p>Select a mail server for the e-mail address specified below.</p> <p>If you do not select a mail server, e-mail notifications cannot be sent via e-mail. You must have configured a mail server already in the Maintenance > Email Notification screen.</p>
3G backup Send Email Title	Type a title that you want to be in the subject line of the e-mail notifications that the Device sends.

Table 10 Network Setting > Broadband > 3G Backup (continued)

LABEL	DESCRIPTION
Send Notification to Email	Notifications are sent to the e-mail address specified in this field. If this field is left blank, notifications cannot be sent via e-mail.
Advanced	Click this to show the advanced 3G backup settings.
Budget Setup	
Enable Budget Control	Select Enable to set a monthly limit for the user account of the installed 3G card. You can set a limit on the total traffic and/or call time. The Device takes the actions you specified when a limit is exceeded during the month.
Time Budget	Select this and specify the amount of time (in hours) that the 3G connection can be used within one month. If you change the value after you configure and enable budget control, the Device resets the statistics.
Data Budget (Mbytes)	<p>Select this and specify how much downstream and/or upstream data (in Mega bytes) can be transmitted via the 3G connection within one month.</p> <p>Select Download/Upload to set a limit on the total traffic in both directions.</p> <p>Select Download to set a limit on the downstream traffic (from the ISP to the Device).</p> <p>Select Upload to set a limit on the upstream traffic (from the Device to the ISP).</p> <p>If you change the value after you configure and enable budget control, the Device resets the statistics.</p>
Data Budget (kPackets)	<p>Select this and specify how much downstream and/or upstream data (in k Packets) can be transmitted via the 3G connection within one month.</p> <p>Select Download/Upload to set a limit on the total traffic in both directions.</p> <p>Select Download to set a limit on the downstream traffic (from the ISP to the Device).</p> <p>Select Upload to set a limit on the upstream traffic (from the Device to the ISP).</p> <p>If you change the value after you configure and enable budget control, the Device resets the statistics.</p>
Reset all budget counters on	Select the date on which the Device resets the budget every month. Select last if you want the Device to reset the budget on the last day of the month. Select specific and enter the number of the date you want the Device to reset the budget
Reset time and data budget counters	Click this button to reset the time and data budgets immediately. The count starts over with the 3G connection's full configured monthly time and data budgets. This does not affect the normal monthly budget restart; so if you configured the time and data budget counters to reset on the second day of the month and you use this button on the first, the time and data budget counters will still reset on the second.
Actions before over budget	Specify the actions the Device takes before the time or data limit exceeds.
Enable % of time budget/data budget (Mbytes)/data budget (kPackets)	Select Enable and enter a number from 1 to 99 in the percentage fields. If you change the value after you configure and enable budget control, the Device resets the statistics.
Actions when over budget	Specify the actions the Device takes when the time or data limit is exceeded.
Current 3G connection	Select Keep to maintain an existing 3G connection or Drop to disconnect it.
Actions	
Enable Email Notification	Select this to enable the e-mail notification function. The Device will e-mail you a notification when there over budget occurs.

Table 10 Network Setting > Broadband > 3G Backup (continued)

LABEL	DESCRIPTION
Mail Server	Select a mail server for the e-mail address specified below. If you do not select a mail server, e-mail notifications cannot be sent via e-mail. You must have configured a mail server already in the Maintenance > Email Notification screen.
Over Budget Email Title	Type a title that you want to be in the subject line of the e-mail notifications that the Device sends.
Send Notification to Email	Notifications are sent to the e-mail address specified in this field. If this field is left blank, notifications cannot be sent via e-mail.
Interval	Enter the interval of how many minutes you want the Device to e-mail you.
Enable Log	Select this to activate the logging function at the interval you set in this field.
Basic	Click this to hide the advanced settings of 3G backup.
Apply	Click Apply to save your changes back to the Device.
Cancel	Click Cancel to return to the previous configuration.

6.4 The Advanced Screen

Use the **Advanced** screen to enable or disable ADSL over PTM, Annex M, DSL PhyR, and SRA (Seamless Rate Adaptation) functions. The Device supports the PhyR retransmission scheme. PhyR is a retransmission scheme designed to provide protection against noise on the DSL line. It improves voice, video and data transmission resilience by utilizing a retransmission buffer.

ITU-T G.993.2 standard defines a wide range of settings for various parameters, some of which are encompassed in profiles as shown in the next table.

Table 11 VDSL Profiles

PROFILE	BANDWIDTH (MHZ)	NUMBER OF DOWNSTREAM CARRIERS	CARRIER BANDWIDTH (KHZ)	POWER (DBM)	MAX. DOWNSTREAM THROUGHPUT (MBIT/S)
8a	8.832	2048	4.3125	17.5	50
8b	8.832	2048	4.3125	20.5	50
8c	8.5	1972	4.3125	11.5	50
8d	8.832	2048	4.3125	14.5	50
12a	12	2783	4.3125	14.5	68
12b	12	2783	4.3125	14.5	68
17a	17.664	4096	4.3125	14.5	100
30a	30	3479	8.625	14.5	200

Click **Network Setting > Broadband > Advanced** to display the following screen.

Figure 26 Network Setting > Broadband > Advanced

When the state of DSL Bonding is changed, The CPE will require a reboot. If xDSL setting is changed, The CPE will require a retrain.

DSL Capabilities

PhyR US : Enable Disable

PhyR DS : Enable Disable

Bitswap : Enable Disable

SRA : Enable Disable

ADSL Modulation

PTM over ADSL : Enable Disable

G.Dmt : Enable Disable

G.lite : Enable Disable

T1.413 : Enable Disable

ADSL2 : Enable Disable

AnnexL : Enable Disable

ADSL2+ : Enable Disable

AnnexM : Enable Disable

VDSL Profile

8a Enabled Enable Disable

8b Enabled Enable Disable

8c Enabled Enable Disable

8d Enabled Enable Disable

12a Enabled Enable Disable

12b Enabled Enable Disable

17a Enabled Enable Disable

US0 Enable Disable

The following table describes the labels in this screen.

Table 12 Network Setting > Broadband > Advanced

LABEL	DESCRIPTION
PhyR US	Enable or disable PhyR US (upstream) for upstream transmission to the WAN. PhyR US should be enabled if data being transmitted upstream is sensitive to noise. However, enabling PhyR US can decrease the US line rate. Enabling or disabling PhyR will require the CPE to retrain. For PhyR to function, the DSLAM must also support PhyR and have it enabled.
PhyR DS	Enable or disable PhyR DS (downstream) for downstream transmission from the WAN. PhyR DS should be enabled if data being transmitted downstream is sensitive to noise. However, enabling PhyR DS can decrease the DS line rate. Enabling or disabling PhyR will require the CPE to retrain. For PhyR to function, the DSLAM must also support PhyR and have it enabled.
Bitswap	
SRA	Enable or disable Seamless Rate Adaption (SRA). Select Enable to have the Device automatically adjust the connection's data rate according to line conditions without interrupting service.
ADSL Modulation	
PTM over ADSL:	Select Enable to use PTM over ADSL. Since PTM has less overhead than ATM, some ISPs use this for better performance.
G.Dmt:	ITU G.992.1 (better known as G.dmt) is an ITU standard for ADSL using discrete multitone modulation. G.dmt full-rate ADSL expands the usable bandwidth of existing copper telephone lines, delivering high-speed data communications at rates up to 8 Mbit/s downstream and 1.3 Mbit/s upstream.

Table 12 Network Setting > Broadband > Advanced (continued)

LABEL	DESCRIPTION
G.lite :	ITU G.992.2 (better known as G.lite) is an ITU standard for ADSL using discrete multitone modulation. G.lite does not strictly require the use of DSL filters, but like all variants of ADSL generally functions better with splitters.
T1.413 :	ANSI T1.413 is a technical standard that defines the requirements for the single asymmetric digital subscriber line (ADSL) for the interface between the telecommunications network and the customer installation in terms of their interaction and electrical characteristics.
ADSL2 :	It optionally extends the capability of basic ADSL in data rates to 12 Mbit/s downstream and, depending on Annex version, up to 3.5 Mbit/s upstream (with a mandatory capability of ADSL2 transceivers of 8 Mbit/s downstream and 800 kbit/s upstream).
AnnexL :	Annex L is an optional specification in the ITU-T ADSL2 recommendation G.992.3 titled Specific requirements for a Reach Extended ADSL2 (READSL2) system operating in the frequency band above POTS, therefore it is often referred to as Reach Extended ADSL2 or READSL2. The main difference between this specification and commonly deployed Annex A is the maximum distance that can be used. The power of the lower frequencies used for transmitting data is boosted up to increase the reach of this signal up to 7 kilometers (23,000 ft).
ADSL2+ :	ADSL2+ extends the capability of basic ADSL by doubling the number of downstream channels. The data rates can be as high as 24 Mbit/s downstream and up to 1.4 Mbit/s upstream depending on the distance from the DSLAM to the customer's premises.
AnnexM :	Annex M is an optional specification in ITU-T recommendations G.992.3 (ADSL2) and G.992.5 (ADSL2+), also referred to as ADSL2 M and ADSL2+ M. This specification extends the capability of commonly deployed Annex A by more than doubling the number of upstream bits. The data rates can be as high as 12 or 24 Mbit/s downstream and 3 Mbit/s upstream depending on the distance from the DSLAM to the customer's premises.
VDSL Profile	VDSL2 profiles differ in the width of the frequency band used to transmit the broadband signal. Profiles that use a wider frequency band can deliver higher maximum speeds.
8a, 8b, 8c, 8d, 12a, 12b, 17a, US0	The G.993.2 VDSL standard defines a wide range of profiles that can be used in different VDSL deployment settings, such as in a central office, a street cabinet or a building. The Device must comply with at least one profile specified in G.993.2. but compliance with more than one profile is allowed.
Apply	Click Apply to save your changes back to the Device.
Cancel	Click Cancel to return to the previous configuration.

6.5 The 802.1x Screen

You can view and configure the 802.1X authentication settings in the **802.1x** screen. Click **Network Setting > Broadband > 802.1x** to display the following screen.

Figure 27 Network Setting > Broadband > 802.1x

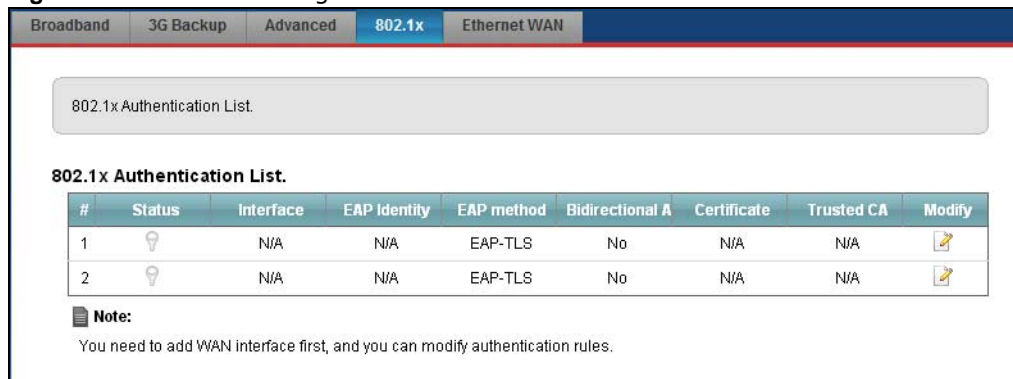

The following table describes the labels in this screen.

Table 13 Network Setting > Network Setting > 802.1x

LABEL	DESCRIPTION
#	This is the index number of the entry.
Status	This field displays whether the authentication is active or not. A yellow bulb signifies that this authentication is active. A gray bulb signifies that this authentication is not active.
Interface	This is the interface that uses the authentication. This displays N/A when there is no interface assigned.
EAP Identity	This shows the EAP identity of the authentication. This displays N/A when there is no EAP identity assigned.
EAP method	This shows the EAP method used in the authentication. This displays N/A when there is no EAP method assigned.
Bidirectional Authentication	This shows whether bidirectional authentication is allowed.
Certificate	This shows the certificate used for this authentication. This displays N/A when there is no certificate assigned.
Trusted CA	This shows the Trusted CA used for this authentication. This displays N/A when there is no Trusted CA assigned.
Modify	Click this icon to edit an item.
Apply	Click Apply to save your changes back to the Device.
Cancel	Click Cancel to return to the previous configuration.

6.5.1 Modify 802.1X Settings

Use this screen to edit 802.1X authentication settings. Click the **Edit** icon next to the rule you want to edit. The screen shown next appears.

Figure 28 Network Setting > Broadband > 802.1x > Modify

The following table describes the labels in this screen.

Table 14 Network Setting > Broadband > 802.1x: Edit

LABEL	DESCRIPTION
Active	This field allows you to activate/deactivate the authentication. Select this to enable the authentication. Clear this to disable this authentication without having to delete the entry.
Interface	Select an interface to which the authentication applies.
EAP Identity	Enter the EAP identity of the authentication.
EAP method	This is the EAP method used for this authentication.
Enable Bidirectional Authentication	Select this to allow bidirectional authentication.
Certificate	Select the certificate you want to assign to the authentication. You need to import the certificate in the Security > Certificates > Local Certificates screen.
Trusted CA	Select the Trusted CA you want to assign to the authentication. You need to import the certificate in the Security > Certificates > Trusted CA screen.
Apply	Click Apply to save your changes.
Cancel	Click Cancel to exit this screen without saving.

6.6 The Ethernet WAN Screen

Use the **Ethernet WAN** screen to convert LAN port number four as a WAN port and to restore it back from a WAN to a LAN port for Ethernet Internet access.

It's not enough to just enable LAN 4 as a WAN connection here. You must also go to **Network Setting > Broadband > Add New WAN Interface** screen and create a new interface for it with the **Type** as **Ethernet** and **Encapsulation** as **IPoE**, and it's advisable to enable **NAT**.

You cannot have DSL Ethernet and 3G WAN connections working at the same time. The order of priority for the WAN connections are:

- 1 DSL
- 2 Ethernet
- 3 3G

Click **Network Setting > Broadband > Ethernet WAN** to display the following screen.

Figure 29 Network Setting > Broadband > Ethernet WAN

The following table describes the labels in this screen.

Table 15 Network Setting > Broadband > Ethernet WAN

LABEL	DESCRIPTION
Enable	Select Enable to convert LAN port number four to a WAN port.
Disable	Select Disable to restore LAN port number four to a LAN port.
Apply	Click Apply to save your changes.
Cancel	Click Cancel to exit this screen without saving.

6.7 Technical Reference

The following section contains additional technical information about the Device features described in this chapter.

Encapsulation

Be sure to use the encapsulation method required by your ISP. The Device can work in bridge mode or routing mode. When the Device is in routing mode, it supports the following methods.

IP over Ethernet

IP over Ethernet (IPoE) is an alternative to PPPoE. IP packets are being delivered across an Ethernet network, without using PPP encapsulation. They are routed between the Ethernet interface and the WAN interface and then formatted so that they can be understood in a bridged environment. For instance, it encapsulates routed Ethernet frames into bridged Ethernet cells.

PPP over ATM (PPPoA)

PPPoA stands for Point to Point Protocol over ATM Adaptation Layer 5 (AAL5). A PPPoA connection functions like a dial-up Internet connection. The Device encapsulates the PPP session based on RFC1483 and sends it through an ATM PVC (Permanent Virtual Circuit) to the Internet Service Provider's (ISP) DSLAM (digital access multiplexer). Please refer to RFC 2364 for more information on PPPoA. Refer to RFC 1661 for more information on PPP.

PPP over Ethernet (PPPoE)

Point-to-Point Protocol over Ethernet (PPPoE) provides access control and billing functionality in a manner similar to dial-up services using PPP. PPPoE is an IETF standard (RFC 2516) specifying how a personal computer (PC) interacts with a broadband modem (DSL, cable, wireless, etc.) connection.

For the service provider, PPPoE offers an access and authentication method that works with existing access control systems (for example RADIUS).

One of the benefits of PPPoE is the ability to let you access one of multiple network services, a function known as dynamic service selection. This enables the service provider to easily create and offer new IP services for individuals.

Operationally, PPPoE saves significant effort for both you and the ISP or carrier, as it requires no specific configuration of the broadband modem at the customer site.

By implementing PPPoE directly on the Device (rather than individual computers), the computers on the LAN do not need PPPoE software installed, since the Device does that part of the task. Furthermore, with NAT, all of the LANs' computers will have access.

RFC 1483

RFC 1483 describes two methods for Multiprotocol Encapsulation over ATM Adaptation Layer 5 (AAL5). The first method allows multiplexing of multiple protocols over a single ATM virtual circuit (LLC-based multiplexing) and the second method assumes that each protocol is carried over a separate ATM virtual circuit (VC-based multiplexing). Please refer to RFC 1483 for more detailed information.

Multiplexing

There are two conventions to identify what protocols the virtual circuit (VC) is carrying. Be sure to use the multiplexing method required by your ISP.

VC-based Multiplexing

In this case, by prior mutual agreement, each protocol is assigned to a specific virtual circuit; for example, VC1 carries IP, etc. VC-based multiplexing may be dominant in environments where dynamic creation of large numbers of ATM VCs is fast and economical.

LLC-based Multiplexing

In this case one VC carries multiple protocols with protocol identifying information being contained in each packet header. Despite the extra bandwidth and processing overhead, this method may be advantageous if it is not practical to have a separate VC for each carried protocol, for example, if charging heavily depends on the number of simultaneous VCs.

Traffic Shaping

Traffic Shaping is an agreement between the carrier and the subscriber to regulate the average rate and fluctuations of data transmission over an ATM network. This agreement helps eliminate congestion, which is important for transmission of real time data such as audio and video connections.

Peak Cell Rate (PCR) is the maximum rate at which the sender can send cells. This parameter may be lower (but not higher) than the maximum line speed. 1 ATM cell is 53 bytes (424 bits), so a maximum speed of 832Kbps gives a maximum PCR of 1962 cells/sec. This rate is not guaranteed because it is dependent on the line speed.

Sustained Cell Rate (SCR) is the mean cell rate of each bursty traffic source. It specifies the maximum average rate at which cells can be sent over the virtual connection. SCR may not be greater than the PCR.

Maximum Burst Size (MBS) is the maximum number of cells that can be sent at the PCR. After MBS is reached, cell rates fall below SCR until cell rate averages to the SCR again. At this time, more cells (up to the MBS) can be sent at the PCR again.

If the PCR, SCR or MBS is set to the default of "0", the system will assign a maximum value that correlates to your upstream line rate.

The following figure illustrates the relationship between PCR, SCR and MBS.

Figure 30 Example of Traffic Shaping

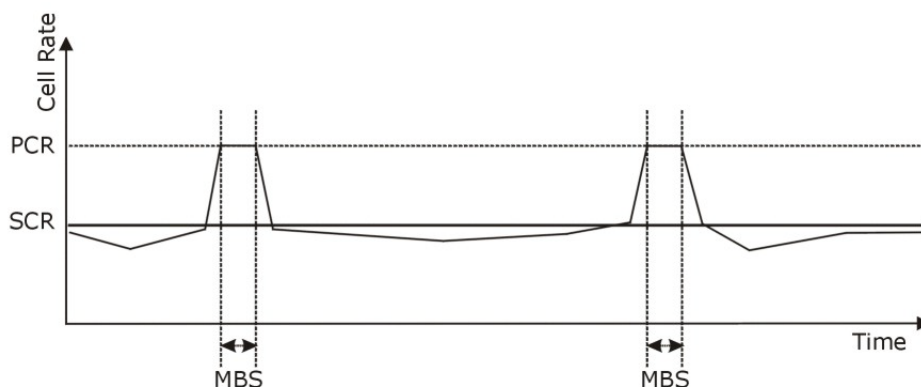

ATM Traffic Classes

These are the basic ATM traffic classes defined by the ATM Forum Traffic Management 4.0 Specification.

Constant Bit Rate (CBR)

Constant Bit Rate (CBR) provides fixed bandwidth that is always available even if no data is being sent. CBR traffic is generally time-sensitive (doesn't tolerate delay). CBR is used for connections that continuously require a specific amount of bandwidth. A PCR is specified and if traffic exceeds this rate, cells may be dropped. Examples of connections that need CBR would be high-resolution video and voice.

Variable Bit Rate (VBR)

The Variable Bit Rate (VBR) ATM traffic class is used with bursty connections. Connections that use the Variable Bit Rate (VBR) traffic class can be grouped into real time (VBR-RT) or non-real time (VBR-nRT) connections.

The VBR-RT (real-time Variable Bit Rate) type is used with bursty connections that require closely controlled delay and delay variation. It also provides a fixed amount of bandwidth (a PCR is specified) but is only available when data is being sent. An example of an VBR-RT connection would be video conferencing. Video conferencing requires real-time data transfers and the bandwidth requirement varies in proportion to the video image's changing dynamics.

The VBR-nRT (non real-time Variable Bit Rate) type is used with bursty connections that do not require closely controlled delay and delay variation. It is commonly used for "bursty" traffic typical on LANs. PCR and MBS define the burst levels, SCR defines the minimum level. An example of an VBR-nRT connection would be non-time sensitive data file transfers.

Unspecified Bit Rate (UBR)

The Unspecified Bit Rate (UBR) ATM traffic class is for bursty data transfers. However, UBR doesn't guarantee any bandwidth and only delivers traffic when the network has spare bandwidth. An example application is background file transfer.

IP Address Assignment

A static IP is a fixed IP that your ISP gives you. A dynamic IP is not fixed; the ISP assigns you a different one each time. The Single User Account feature can be enabled or disabled if you have either a dynamic or static IP. However the encapsulation method assigned influences your choices for IP address and default gateway.

Introduction to VLANs

A Virtual Local Area Network (VLAN) allows a physical network to be partitioned into multiple logical networks. Devices on a logical network belong to one group. A device can belong to more than one group. With VLAN, a device cannot directly talk to or hear from devices that are not in the same group(s); the traffic must first go through a router.

In Multi-Tenant Unit (MTU) applications, VLAN is vital in providing isolation and security among the subscribers. When properly configured, VLAN prevents one subscriber from accessing the network resources of another on the same LAN, thus a user will not see the printers and hard disks of another user in the same building.

VLAN also increases network performance by limiting broadcasts to a smaller and more manageable logical broadcast domain. In traditional switched environments, all broadcast packets go to each and every individual port. With VLAN, all broadcasts are confined to a specific broadcast domain.

Introduction to IEEE 802.1Q Tagged VLAN

A tagged VLAN uses an explicit tag (VLAN ID) in the MAC header to identify the VLAN membership of a frame across bridges - they are not confined to the switch on which they were created. The VLANs can be created statically by hand or dynamically through GVRP. The VLAN ID associates a frame with a specific VLAN and provides the information that switches need to process the frame across the network. A tagged frame is four bytes longer than an untagged frame and contains two bytes of TPID (Tag Protocol Identifier), residing within the type/length field of the Ethernet frame) and two bytes of TCI (Tag Control Information), starts after the source address field of the Ethernet frame).

The CFI (Canonical Format Indicator) is a single-bit flag, always set to zero for Ethernet switches. If a frame received at an Ethernet port has a CFI set to 1, then that frame should not be forwarded as it is to an untagged port. The remaining twelve bits define the VLAN ID, giving a possible maximum number of 4,096 VLANs. Note that user priority and VLAN ID are independent of each other. A frame with VID (VLAN Identifier) of null (0) is called a priority frame, meaning that only the priority level is significant and the default VID of the ingress port is given as the VID of the frame. Of the 4096 possible VIDs, a VID of 0 is used to identify priority frames and value 4095 (FFF) is reserved, so the maximum possible VLAN configurations are 4,094.

TPID	User Priority	CFI	VLAN ID
2 Bytes	3 Bits	1 Bit	12 Bits

Multicast

IP packets are transmitted in either one of two ways - Unicast (1 sender - 1 recipient) or Broadcast (1 sender - everybody on the network). Multicast delivers IP packets to a group of hosts on the network - not everybody and not just 1.

Internet Group Multicast Protocol (IGMP) is a network-layer protocol used to establish membership in a Multicast group - it is not used to carry user data. IGMP version 2 (RFC 2236) is an improvement over version 1 (RFC 1112) but IGMP version 1 is still in wide use. If you would like to read more detailed information about interoperability between IGMP version 2 and version 1, please see sections 4 and 5 of RFC 2236. The class D IP address is used to identify host groups and can be in the range 224.0.0.0 to 239.255.255.255. The address 224.0.0.0 is not assigned to any group and is used by IP multicast computers. The address 224.0.0.1 is used for query messages and is assigned to the permanent group of all IP hosts (including gateways). All hosts must join the 224.0.0.1 group in order to participate in IGMP. The address 224.0.0.2 is assigned to the multicast routers group.

At start up, the Device queries all directly connected networks to gather group membership. After that, the Device periodically updates this information.

DNS Server Address Assignment

Use Domain Name System (DNS) to map a domain name to its corresponding IP address and vice versa, for instance, the IP address of www.zyxel.com is 204.217.0.2. The DNS server is extremely

important because without it, you must know the IP address of a computer before you can access it.

The Device can get the DNS server addresses in the following ways.

- 1 The ISP tells you the DNS server addresses, usually in the form of an information sheet, when you sign up. If your ISP gives you DNS server addresses, manually enter them in the DNS server fields.
- 2 If your ISP dynamically assigns the DNS server IP addresses (along with the Device's WAN IP address), set the DNS server fields to get the DNS server address from the ISP.

IPv6 Addressing

The 128-bit IPv6 address is written as eight 16-bit hexadecimal blocks separated by colons (:). This is an example IPv6 address `2001:0db8:1a2b:0015:0000:0000:1a2f:0000`.

IPv6 addresses can be abbreviated in two ways:

- Leading zeros in a block can be omitted. So `2001:0db8:1a2b:0015:0000:0000:1a2f:0000` can be written as `2001:db8:1a2b:15:0:0:1a2f:0`.
- Any number of consecutive blocks of zeros can be replaced by a double colon. A double colon can only appear once in an IPv6 address. So `2001:0db8:0000:0000:1a2f:0000:0000:0015` can be written as `2001:0db8::1a2f:0000:0000:0015`, `2001:0db8:0000:0000:1a2f::0015`, `2001:db8::1a2f:0:0:15` or `2001:db8:0:0:1a2f::15`.

IPv6 Prefix and Prefix Length

Similar to an IPv4 subnet mask, IPv6 uses an address prefix to represent the network address. An IPv6 prefix length specifies how many most significant bits (start from the left) in the address compose the network address. The prefix length is written as "/x" where x is a number. For example,

```
2001:db8:1a2b:15::1a2f:0/32
```

means that the first 32 bits (`2001:db8`) is the subnet prefix.

7.1 Overview

This chapter describes the Device's **Network Setting** > **Wireless** screens. Use these screens to set up your Device's wireless connection.

7.1.1 What You Can Do in this Chapter

This section describes the Device's **Wireless** screens. Use these screens to set up your Device's wireless connection.

- Use the **General** screen to enable the Wireless LAN, enter the SSID and select the wireless security mode ([Section 7.2 on page 95](#)).
- Use the **Guest / More AP** screen to set up multiple wireless networks on your Device ([Section 7.3 on page 99](#)).
- Use the **MAC Authentication** screen to allow or deny wireless clients based on their MAC addresses from connecting to the Device ([Section 7.4 on page 102](#)).
- Use the **WPS** screen to enable or disable WPS, view or generate a security PIN (Personal Identification Number) ([Section 7.5 on page 103](#)).
- Use the **WMM** screen to enable Wi-Fi MultiMedia (WMM) to ensure quality of service in wireless networks for multimedia applications ([Section 7.6 on page 105](#)).
- Use the **WDS** screen to set up a Wireless Distribution System, in which the Device acts as a bridge with other ZyXEL access points ([Section 7.7 on page 106](#)).
- Use the **Others** screen to configure wireless advanced features, such as the RTS/CTS Threshold ([Section 7.8 on page 108](#)).
- Use the **Channel Status** screen to scan wireless LAN channel noises and view the results ([Section 7.9 on page 110](#)).

7.1.2 What You Need to Know

Wireless Basics

"Wireless" is essentially radio communication. In the same way that walkie-talkie radios send and receive information over the airwaves, wireless networking devices exchange information with one another. A wireless networking device is just like a radio that lets your computer exchange information with radios attached to other computers. Like walkie-talkies, most wireless networking devices operate at radio frequency bands that are open to the public and do not require a license to use. However, wireless networking is different from that of most traditional radio communications in that there are a number of wireless networking standards available with different methods of data encryption.

Finding Out More

See [Section 7.10 on page 111](#) for advanced technical information on wireless networks.

7.2 The General Screen

Use this screen to enable the Wireless LAN, enter the SSID and select the wireless security mode.

Note: If you are configuring the Device from a computer connected to the wireless LAN and you change the Device's SSID, channel or security settings, you will lose your wireless connection when you press **Apply** to confirm. You must then change the wireless settings of your computer to match the Device's new settings.

Click **Network Setting** > **Wireless** to open the **General** screen.

Figure 31 Network Setting > Wireless > General

Wireless Network Setup

Band : 2.4GHz ▾

Wireless Enable Disabled (settings are invalid when disabled)

Channel : Auto ▾ Current: 12 [more...](#)

Wireless Network Settings

Wireless Network Name (SSID) : ZyXEL000001

Max clients: 16

Hide SSID

Enhanced Multicast Forwarding

Max. Upstream Bandwidth: Kbps

Max. Downstream Bandwidth: Kbps

Notes:

1. Max. Upstream Bandwidth: This field allow user configure the maximum bandwidth of this SSID to WAN.
2. Max. Downstream Bandwidth: This field allow user configure the maximum bandwidth of WAN to this SSID.
3. If Max. Upstream/Downstream Bandwidth is empty, the CPE sets the value automatically.

BSSID: CC:5D:4E:00:00:02

E-mail notification when the wireless guest visit

Enable Email Notification

Security Level

No Security Basic More Secure (Recommended)

Security Mode: WPA2-PSK ▾

Generate password automatically

Enter 8-63 characters (a-z, A-Z, 0-9, "!", "_" and "."), other characters are not allowed.

Password: 432D54BEE9 [more...](#)
8C

The following table describes the general wireless LAN labels in this screen.

Table 16 Network Setting > Wireless > General

LABEL	DESCRIPTION
Wireless Network Setup	
Wireless	You can Enable or Disable the wireless LAN in this field.
Band	This shows the wireless band which this radio profile is using. 2.4GHz is the frequency used by IEEE 802.11b/g/n wireless clients.
Channel	Use Auto to have the Device automatically determine a channel to use.
more.../less	Click more... to show more information. Click less to hide them.
Bandwidth	Select whether the Device uses a wireless channel width of 20MHz or 40MHz . A standard 20MHz channel offers transfer speeds of up to 150Mbps whereas a 40MHz channel uses two standard channels and offers speeds of up to 300 Mbps. 40MHz (channel bonding or dual channel) bonds two adjacent radio channels to increase throughput. The wireless clients must also support 40 MHz. It is often better to use the 20 MHz setting in a location where the environment hinders the wireless signal. Select 20MHz if you want to lessen radio interference with other wireless devices in your neighborhood or the wireless clients do not support channel bonding.
Control Sideband	This is available for some regions when you select a specific channel and set the Bandwidth field to 40MHz . Set whether the control channel (set in the Channel field) should be in the Lower or Upper range of channel bands.
Passphrase Type	If you set security for the wireless LAN and have the Device generate a password, the setting in this field determines how the Device generates the password. Select None to set the Device's password generation to not be based on a passphrase. Select Fixed to use a 16 character passphrase for generating a password. Select Variable to use a 16 to 63 character passphrase for generating a password.
Passphrase Key	For a fixed type passphrase enter 16 alphanumeric characters (0-9, A-Z, with no spaces). It must contain both letters and numbers and is case-sensitive. For a variable type passphrase enter 16 to 63 alphanumeric characters (0-9, A-Z, with no spaces). It must contain both letters and numbers and is case-sensitive.
Wireless Network Settings	
Wireless Network Name (SSID)	The SSID (Service Set IDentity) identifies the service set with which a wireless device is associated. Wireless devices associating to the access point (AP) must have the same SSID. Enter a descriptive name (up to 32 English keyboard characters) for the wireless LAN.
Max clients	Specify the maximum number of clients that can connect to this network at the same time.
Hide SSID	Select this check box to hide the SSID in the outgoing beacon frame so a station cannot obtain the SSID through scanning using a site survey tool.
Enhanced Multicast Forwarding	Select this check box to allow the Device to convert wireless multicast traffic into wireless unicast traffic.
Max. Upstream Bandwidth	Specify the maximum rate for upstream wireless traffic to the WAN from this WLAN in kilobits per second (Kbps).
Max. Downstream Bandwidth	Specify the maximum rate for downstream wireless traffic to this WLAN from the WAN in kilobits per second (Kbps).
BSSID	This shows the MAC address of the wireless interface on the Device when wireless LAN is enabled.
Security Level	

Table 16 Network Setting > Wireless > General (continued)

LABEL	DESCRIPTION
Security Mode	Select Basic (WEP, 802.1X) or More Secure (WPA(2)-PSK) to add security on this wireless network. The wireless clients which want to associate to this network must have same wireless security settings as the Device. When you select to use a security, additional options appears in this screen. Or you can select No Security to allow any client to associate this network without any data encryption or authentication. See the following sections for more details about this field.
Apply	Click Apply to save your changes.
Cancel	Click Cancel to restore your previously saved settings.

7.2.1 No Security

Select **No Security** to allow wireless stations to communicate with the access points without any data encryption or authentication.

Note: If you do not enable any wireless security on your Device, your network is accessible to any wireless networking device that is within range.

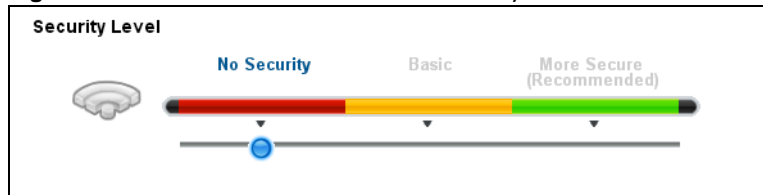
Figure 32 Wireless > General: No Security

The following table describes the labels in this screen.

Table 17 Wireless > General: No Security

LABEL	DESCRIPTION
Security Level	Choose No Security to allow all wireless connections without data encryption or authentication.

7.2.2 Basic (WEP Encryption)

WEP encryption scrambles the data transmitted between the wireless stations and the access points (AP) to keep network communications private. Both the wireless stations and the access points must use the same WEP key.

Note: WEP is extremely insecure. Its encryption can be broken by an attacker, using widely-available software. It is strongly recommended that you use a more effective security mechanism. Use the strongest security mechanism that all the wireless devices in your network support. For example, use WPA-PSK or WPA2-PSK if all your wireless devices support it, or use WPA or WPA2 if your wireless devices support it and you have a RADIUS server. If your wireless devices support nothing stronger than WEP, use the highest encryption level available.

Your Device allows you to configure up to four 64-bit or 128-bit WEP keys but only one key can be enabled at any one time.

In order to configure and enable WEP encryption, click **Network Setting > Wireless** to display the **General** screen, then select **Basic** as the security level.

Figure 33 Wireless > General: Basic (WEP)

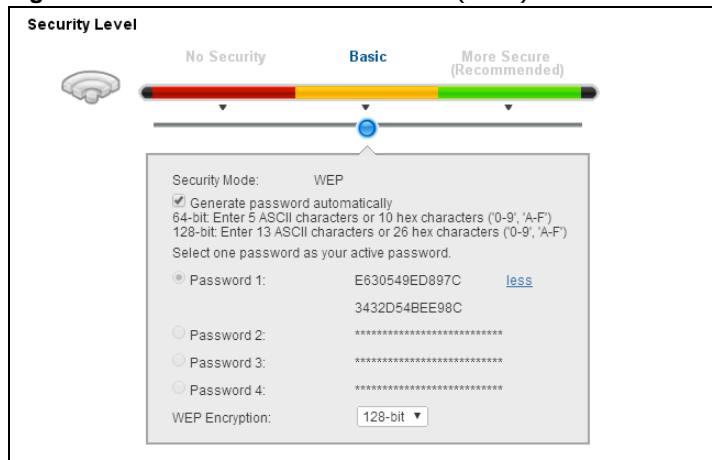

The following table describes the labels in this screen.

Table 18 Wireless > General: Basic (WEP)

LABEL	DESCRIPTION
Security Level	Select Basic to enable WEP data encryption.
Generate password automatically	Select this option to have the Device automatically generate a password. The password field will not be configurable when you select this option.
Password 1~4	The password (WEP keys) are used to encrypt data. Both the Device and the wireless stations must use the same password (WEP key) for data transmission. If you chose 64-bit WEP, then enter any 5 ASCII characters or 10 hexadecimal characters ("0-9", "A-F"). If you chose 128-bit WEP, then enter 13 ASCII characters or 26 hexadecimal characters ("0-9", "A-F"). You must configure at least one password, only one password can be activated at any one time.
more.../less	Click more... to show more fields in this section. Click less to hide them.
WEP Encryption	Select 64-bits or 128-bits . This dictates the length of the security key that the network is going to use.

7.2.3 More Secure (WPA(2)-PSK)

The WPA-PSK security mode provides both improved data encryption and user authentication over WEP. Using a Pre-Shared Key (PSK), both the Device and the connecting client share a common password in order to validate the connection. This type of encryption, while robust, is not as strong as WPA, WPA2 or even WPA2-PSK. The WPA2-PSK security mode is a newer, more robust version of the WPA encryption standard. It offers slightly better security, although the use of PSK makes it less robust than it could be.

Click **Network Setting > Wireless** to display the **General** screen. Select **More Secure** as the security level. Then select **WPA-PSK** or **WPA2-PSK** from the **Security Mode** list.

Figure 34 Wireless > General: More Secure: WPA(2)-PSK

Security Level

No Security Basic **More Secure (Recommended)**

Security Mode: WPA2-PSK

Generate password automatically

Enter 8-63 characters (a-z, A-Z, 0-9, '-', '_', and '!'), other characters are not allowed.

Password: 432D54BEE9 [less](#)

8C

WPA-PSK Compatible: Enable Disable

Encryption: TKIP+AES

Group Key Update Timer: 1800 sec

The following table describes the labels in this screen.

Table 19 Wireless > General: More Secure: WPA(2)-PSK

LABEL	DESCRIPTION
Security Level	Select More Secure to enable WPA(2)-PSK data encryption.
Security Mode	Select WPA-PSK or WPA2-PSK from the drop-down list box.
Generate password automatically	Select this option to have the Device automatically generate a password. The password field will not be configurable when you select this option.
Password	The encryption mechanisms used for WPA(2) and WPA(2)-PSK are the same. The only difference between the two is that WPA(2)-PSK uses a simple common password, instead of user-specific credentials. If you did not select Generate password automatically , you can manually type a pre-shared key from 8 to 64 case-sensitive keyboard characters.
more.../less	Click more... to show more fields in this section. Click less to hide them.
WPA-PSK Compatible	This field appears when you choose WPA-PSK2 as the Security Mode . Check this field to allow wireless devices using WPA-PSK security mode to connect to your Device. The Device supports WPA-PSK and WPA2-PSK simultaneously.
Encryption	Select the encryption type (TKIP , AES or TKIP+AES) for data encryption. Select TKIP if your wireless clients can all use TKIP. Select AES if your wireless clients can all use AES. Select TKIP+AES to allow the wireless clients to use either TKIP or AES.
Group Key Update Timer	The Group Key Update Timer is the rate at which the RADIUS server sends a new group key out to all clients.

7.3 The Guest / More AP Screen

This screen allows you to enable and configure multiple Basic Service Sets (BSSs) on the Device.

Click **Network Setting > Wireless > Guest / More AP**. The following screen displays.

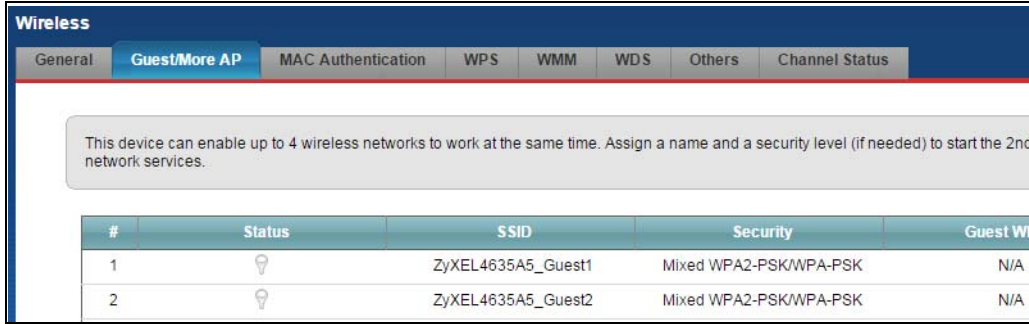
Figure 35 Network Setting > Wireless > Guest / More AP

#	Status	SSID	Security	Guest WLAN
1		ZyXEL4635A5_Guest1	Mixed WPA2-PSK/WPA-PSK	N/A
2		ZyXEL4635A5_Guest2	Mixed WPA2-PSK/WPA-PSK	N/A

The following table describes the labels in this screen.

Table 20 Network Setting > Wireless > Guest / More AP

LABEL	DESCRIPTION
#	This is the index number of the entry.
Status	This field indicates whether this SSID is active. A yellow bulb signifies that this SSID is active. A gray bulb signifies that this SSID is not active.
SSID	An SSID profile is the set of parameters relating to one of the Device's BSSs. The SSID (Service Set Identifier) identifies the Service Set with which a wireless device is associated. This field displays the name of the wireless profile on the network. When a wireless client scans for an AP to associate with, this is the name that is broadcast and seen in the wireless client utility.
Security	This field indicates the security mode of the SSID profile.
Guest WLAN	This displays if the guest WLAN function has been enabled for this WLAN. If Home Guest displays, clients can connect to each other directly. If External Guest displays, clients are blocked from connecting to each other directly. N/A displays if guest WLAN is disabled.
Modify	Click the Edit icon to configure the SSID profile.

7.3.1 Edit Guest / More AP

Use this screen to edit an SSID profile. Click the **Edit** icon next to an SSID in the **Guest / More AP** screen. The following screen displays.

Figure 36 Network Setting > Wireless > Guest / More AP > Edit

Wireless Network Setup

Wireless : Enable Disabled (The settings in this screen are invalid if you select this.)

Passphrase Type :

Wireless Network Settings

Wireless Network Name(SSID):

Max clients:

Hide SSID

Enhanced Multicast Forwarding

Guest WLAN

Access Scenario:

Max. Upstream Bandwidth: Kbps

Max. Downstream Bandwidth: Kbps

Notes:

- 1.Max. Upstream Bandwidth:This field allow user configure the maximum bandwidth of this SSID to WAN.
- 2.Max. Downstream Bandwidth:This field allow user configure the maximum bandwidth of WAN to this SSID.
- 3.If Max. Upstream/Downstream Bandwidth is empty, the CPE sets the value automatically.

BSSID: 72:5D:4E:00:00:03

E-mail notification when the wireless guest visit

Enable Email Notification

SSID Subnet: Enable Disabled

Security Level

No Security Basic **More Secure (Recommended)**

Security Mode:

Generate password automatically
Enter 8-63 characters (a-z, A-Z, 0-9, '-', '_', and '.'), other characters are not allowed.

Password: [more...](#)

password unmask

OK Cancel

The following table describes the fields in this screen.

Table 21 Network Setting > Wireless > Guest / More AP > Edit

LABEL	DESCRIPTION
Wireless Network Setup	
Wireless	You can Enable or Disable the wireless LAN in this field.
Passphrase Type	Passphrase type cannot be changed. The default is None .
Wireless Network Settings	
Wireless Network Name (SSID)	The SSID (Service Set Identity) identifies the service set with which a wireless device is associated. Wireless devices associating to the access point (AP) must have the same SSID. Enter a descriptive name (up to 32 English keyboard characters) for the wireless LAN.
Max clients	Specify the maximum number of clients that can connect to this network at the same time.
Hide SSID	Select this check box to hide the SSID in the outgoing beacon frame so a station cannot obtain the SSID through scanning using a site survey tool.

Table 21 Network Setting > Wireless > Guest / More AP > Edit (continued)

LABEL	DESCRIPTION
Enhanced Multicast Forwarding	Select this check box to allow the Device to convert wireless multicast traffic into wireless unicast traffic.
Guest WLAN	Select this to create Guest WLANs for home and external clients. Select the WLAN type in the Access Scenario field.
Access Scenario	If you select Home Guest , clients can connect to each other directly. If you select External Guest , clients are blocked from connecting to each other directly.
Maximum Upstream Bandwidth	Specify the maximum rate for upstream wireless traffic to the WAN from this WLAN in kilobits per second (Kbps).
Maximum Downstream Bandwidth	Specify the maximum rate for downstream wireless traffic to this WLAN from the WAN in kilobits per second (Kbps).
BSSID	This shows the MAC address of the wireless interface on the Device when wireless LAN is enabled.
E-mail notification when the wireless guest visit	
Enable Email Notification	Select this to have the Device e-mail you a notification when a wireless client is connected to the wireless network.
Mail Server	Select a mail server for the e-mail address specified below. If you do not select a mail server, e-mail notifications cannot be sent via e-mail. You must have configured a mail server already in the Maintenance > Email Notification screen.
Email Title	Type a title that you want to be in the subject line of the e-mail notifications that the Device sends.
Send Notification to Email	Notifications are sent to the e-mail address specified in this field. If this field is left blank, notifications cannot be sent via e-mail.
Security Level	
Security Mode	Select Basic (WEP, 802.1X) or More Secure (WPA(2)-PSK) to add security on this wireless network. The wireless clients which want to associate to this network must have same wireless security settings as the Device. After you select to use a security, additional options appears in this screen. Or you can select No Security to allow any client to associate this network without any data encryption or authentication. See Section 7.2.1 on page 97 for more details about this field.
Apply	Click Apply to save your changes.
Cancel	Click Cancel to exit this screen without saving.

7.4 MAC Authentication

This screen allows you to configure the Device to give exclusive access to specific devices (**Allow**) or exclude specific devices from accessing the Device (**Deny**). Every Ethernet device has a unique MAC (Media Access Control) address. The MAC address is assigned at the factory and consists of six pairs of hexadecimal characters, for example, 00:A0:C5:00:00:02. You need to know the MAC addresses of the devices to configure this screen.

Use this screen to view your Device's MAC filter settings and add new MAC filter rules. Click **Network Setting > Wireless > MAC Authentication**. The screen appears as shown.

Figure 37 Wireless > MAC Authentication

MAC Authentication can allow or block the access of the device(s) to your wireless network. Edit the list in the table to decide the rule of the access on device(s).

General

SSID : ZyXEL000001_Guest1

MAC Restrict Mode : Disabled Allow Deny

MAC address List

Add new MAC address

#	MAC Address	Modify
---	-------------	--------

Notes:

Note: If mode of first SSID 'allow' is choosed and MAC list is empty, WPS will be disabled

Apply Cancel

The following table describes the labels in this screen.

Table 22 Wireless > MAC Authentication

LABEL	DESCRIPTION
SSID	Select the SSID for which you want to configure MAC filter settings.
MAC Restrict Mode	Define the filter action for the list of MAC addresses in the MAC Address table. Select Disable to turn off MAC filtering. Select Deny to block access to the Device. MAC addresses not listed will be allowed to access the Device. Select Allow to permit access to the Device. MAC addresses not listed will be denied access to the Device.
Add new MAC address	Click this if you want to add a new MAC address entry to the MAC filter list below. Enter the MAC addresses of the wireless devices that are allowed or denied access to the Device in these address fields. Enter the MAC addresses in a valid MAC address format, that is, six hexadecimal character pairs, for example, 12:34:56:78:9a:bc.
#	This is the index number of the entry.
MAC Address	This is the MAC addresses of the wireless devices that are allowed or denied access to the Device.
Delete	Click the Delete icon to delete the entry.
Apply	Click Apply to save your changes.
Cancel	Click Cancel to exit this screen without saving.

7.5 The WPS Screen

Use this screen to configure WiFi Protected Setup (WPS) on your Device.

WPS allows you to quickly set up a wireless network with strong security, without having to configure security settings manually. Set up each WPS connection between two devices. Both devices must support WPS. See [Section 7.10.9.3 on page 120](#) for more information about WPS.

Note: The Device applies the security settings of the **SSID1** profile (see [Section 7.2 on page 95](#)). If you want to use the WPS feature, make sure you have set the security mode of **SSID1** to **WPA2-PSK** or **No Security**.

Click **Network Setting > Wireless > WPS**. The following screen displays. Select **Enable** and click **Apply** to activate the WPS function. Then you can configure the WPS settings in this screen.

Figure 38 Network Setting > Wireless > WPS

Wi-Fi Protected Setup (WPS) lets you set up wireless security easily. Select a method for establishing a WPS connection between the router and another WPS-compatible device.

2.4GHz WPS Setup

WPS :

Method	Enable	Status
1	<input type="radio"/>	Disabled
2	<input type="radio"/>	Disabled
3	<input type="radio"/>	Disabled

Method 1: Push Button Configuration

1. Click 'Connect'.

Connect

2. Activate WPS on the wireless client within 2 minutes after clicking "Connect".

Method 2: Register Wireless Client PIN Number

1. Enter the PIN of your wireless client and click 'Register'.

Register

2. Activate WPS on the wireless client within 2 minutes after clicking "Connect".

Method 3: Enter AP's PIN Number in Wireless Client

Current state: Configured

1. Please release configuration if you want to configure the wireless settings.

Release Configuration

2. Enter current PIN on your wireless client.

Generate New PIN Number

Notes:

- This function only works on the first SSID.
- Click the 'Release Configuration' button to have the WPS status changed to 'Unconfigured'. Otherwise, WPS status is in 'Configured' mode.

Apply **Cancel**

The following table describes the labels in this screen.

Table 23 Network Setting > Wireless > WPS

LABEL	DESCRIPTION
2.4GHz WPS Setup	
WPS	
Method 1	Use this section to set up a WPS wireless network using Push Button Configuration (PBC). Select Enable and click Apply to activate WPS method 1 on the Device.
Connect	Click this button to add another WPS-enabled wireless device (within wireless range of the Device) to your wireless network. This button may either be a physical button on the outside of device, or a menu button similar to the Connect button on this screen. Note: You must press the other wireless device's WPS button within two minutes of pressing this button.
Method 2	Use this section to set up a WPS wireless network by entering the PIN of the client into the Device. Select Enable and click Apply to activate WPS method 2 on the Device.

Table 23 Network Setting > Wireless > WPS (continued)

LABEL	DESCRIPTION
Register	Enter the PIN of the device that you are setting up a WPS connection with and click Register to authenticate and add the wireless device to your wireless network. You can find the PIN either on the outside of the device, or by checking the device's settings. Note: You must also activate WPS on that device within two minutes to have it present its PIN to the Device.
Method 3	Use this section to set up a WPS wireless network by entering the PIN of the Device into the client. Select Enable and click Apply to activate WPS method 3 on the Device.
Release Configuration	The default WPS status is configured. Click this button to remove all configured wireless and wireless security settings for WPS connections on the Device.
Generate New PIN Number	If this method has been enabled, the PIN (Personal Identification Number) of the Device is shown here. Enter this PIN in the configuration utility of the device you want to connect to using WPS. The PIN is not necessary when you use WPS push-button method. Click the Generate New PIN Number button to have the Device create a new PIN.
Apply	Click Apply to save your changes.
Cancel	Click Cancel to restore your previously saved settings.

7.6 The WMM Screen

Use this screen to enable Wi-Fi MultiMedia (WMM) and WMM Power Save in wireless networks for multimedia applications.

Click **Network Setting > Wireless > WMM**. The following screen displays.

Figure 39 Network Setting > Wireless > WMM

WMM and APSD have beneficial effects on delay-sensitive applications over wireless connection, such as VoIP and multimedia streaming, because WMM enhances data transmission quality and APSD improves power management on wireless clients.

2.4GHz WMM Setup

WMM : Enable Disabled

WMM Automatic Power Save Delivery (APSD) : Enable Disabled

Apply Cancel

The following table describes the labels in this screen.

Table 24 Network Setting > Wireless > WMM

LABEL	DESCRIPTION
2.4GHz WMM Setup	
WMM	Select On to have the Device automatically give a service a priority level according to the ToS value in the IP header of packets it sends. WMM QoS (Wifi MultiMedia Quality of Service) gives high priority to voice and video, which makes them run more smoothly.
WMM Automatic Power Save Delivery	Select this option to extend the battery life of your mobile devices (especially useful for small devices that are running multimedia applications). The Device goes to sleep mode to save power when it is not transmitting data. The AP buffers the packets sent to the Device until the Device "wakes up". The Device wakes up periodically to check for incoming data. Note: Note: This works only if the wireless device to which the Device is connected also supports this feature.
Apply	Click Apply to save your changes.
Cancel	Click Cancel to restore your previously saved settings.

7.7 The WDS Screen

An AP using the Wireless Distribution System (WDS) can function as a wireless network bridge allowing you to wirelessly connect two wired network segments. The **WDS** screen allows you to configure the Device to connect to two or more APs wirelessly when WDS is enabled.

Use this screen to set up your WDS (Wireless Distribution System) links between the Device and other wireless APs. You need to know the MAC address of the peer device. Once the security settings of peer sides match one another, the connection between devices is made.

Note: WDS security is independent of the security settings between the Device and any wireless clients.

Note: At the time of writing, WDS is compatible with other ZyXEL APs only. Not all models support WDS links. Check your other AP's documentation.

Click **Network Setting > Wireless > WDS**. The following screen displays.

Figure 40 Network Setting > Wireless > WDS

This page allows you to set the operating mode of your device to Access Point (AP) or Wireless Bridge. Select Wireless Bridge to disable AP functionality. Select Access Point to enable your device to act as an access point while on bridge mode so that other wireless stations are still able to associate with the AP. Select Disable in Bridge Restrict to enable any wireless station to establish a wireless bridge connection to the device. Select Enable in Bridge Restrict to limit wireless bridge connections only to wireless stations listed in the table.

2.4GHz Wireless Bridge Setup

AP Mode:

Bridge Restrict: Enabled Disabled

Remote Bridges MAC Address

#	MAC Address	Modify	Scan
1			
2			
3			
4			

Notes:

1. The WDS function only works when the security mode is set to No Security, WEP, WPA-PSK and WPA2-PSK.
2. The WDS connection security mode is based on the settings configured in the Wireless > General screen.
3. The WDS function only works with the first SSID.
4. If the AP mode is Wireless Bridge, WPS will be disabled.
5. The SSID should be the same in both WPA-PSK or WPA2-PSK security modes.

The following table describes the labels in this screen.

Table 25 Network Setting > Wireless > WDS

LABEL	DESCRIPTION
2.4GHz Wireless Bridge Setup	
AP Mode	Select the operating mode for your Device. <ul style="list-style-type: none"> • Access Point - The Device functions as a bridge and access point simultaneously. • Wireless Bridge - The Device acts as a wireless network bridge and establishes wireless links with other APs. In this mode, clients cannot connect to the Device wirelessly.
Bridge Restrict	This field is available only when you set operating mode to Access Point . Select Enabled to turn on WDS and enter the peer device's MAC address manually in the table below. Select Disable to turn off WDS.
Remote Bridge MAC Address	You can enter the MAC address of the peer device by clicking the Edit icon under Modify .
#	This is the index number of the entry.
MAC Address	This shows the MAC address of the peer device. You can connect to up to 4 peer devices.
Modify	Click the Edit icon and type the MAC address of the peer device in a valid MAC address format (six hexadecimal character pairs, for example 12:34:56:78:9a:bc). Click the Delete icon to remove this entry.
Scan	Click the Scan icon to search and display the available APs within range.
Apply	Click Apply to save your changes.
Cancel	Click Cancel to restore your previously saved settings.

7.7.1 WDS Scan

You can click the **Scan** icon in **Wireless > WDS** to have the Device automatically search and display the available APs within range. Select an AP and click **Apply** to have the Device establish a wireless link with the selected wireless device.

Figure 41 WDS: Scan

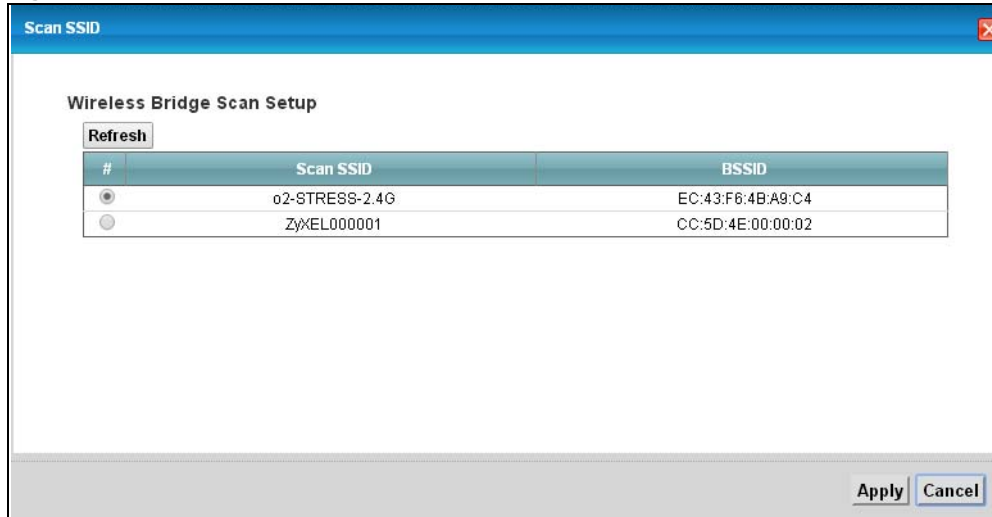

The following table describes the labels in this screen.

Table 26 WDS: Scan

LABEL	DESCRIPTION
Wireless Bridge Scan Setup	
Refresh	Click Refresh to update the table.
#	This is the index number of the entry.
SSID	This shows the SSID of the available wireless device within range.
BSSID	This shows the MAC address of the available wireless device within range.
Apply	Click Apply to save your changes.
Cancel	Click Cancel to restore your previously saved settings.

7.8 The Others Screen

Use this screen to configure advanced wireless settings. Click **Network Setting > Wireless > Others**. The screen appears as shown.

See [Section 7.10.2 on page 113](#) for detailed definitions of the terms listed in this screen.

Figure 42 Network Setting > Wireless > Others

The configurations below are the advanced wireless settings.

2.4GHz Wireless Advanced Setup

RTS/CTS Threshold : 2347

Fragmentation Threshold : 2346

Auto Channel Timer : 2 min

Output Power : 100%

Beacon Interval : 100 ms

DTIM Interval : 1 ms

802.11 Mode : 802.11b/g/n Mixed

802.11 Protection : Off

Preamble : Long

RIFS Advertisement : Auto

WPS 2.0 :

RX Chain Power Save : Enable

XPress™ Technology : Enable

OBSS Coexistence : Enable

Apply Cancel

The following table describes the labels in this screen.

Table 27 Network Setting > Wireless > Others

LABEL	DESCRIPTION
RTS/CTS Threshold	Data with its frame size larger than this value will perform the RTS (Request To Send)/CTS (Clear To Send) handshake. Enter a value between 0 and 2347.
Fragmentation Threshold	This is the maximum data fragment size that can be sent. Enter a value between 256 and 2346.
Auto Channel Timer	If you set the channel to Auto in the Network Setting > Wireless > General screen, specify the interval in minutes for how often the Device scans for the best channel. Enter 0 to disable the periodical scan.
Output Power	Set the output power of the Device. If there is a high density of APs in an area, decrease the output power to reduce interference with other APs. Select one of the following: 20%, 40%, 60%, 80% or 100% .
Beacon Interval	When a wirelessly networked device sends a beacon, it includes with it a beacon interval. This specifies the time period before the device sends the beacon again. The interval tells receiving devices on the network how long they can wait in low power mode before waking up to handle the beacon. This value can be set from 50ms to 1000ms. A high value helps save current consumption of the access point.
DTIM Interval	Delivery Traffic Indication Message (DTIM) is the time period after which broadcast and multicast packets are transmitted to mobile clients in the Power Saving mode. A high DTIM value can cause clients to lose connectivity with the network. This value can be set from 1 to 255.

Table 27 Network Setting > Wireless > Others (continued)

LABEL	DESCRIPTION
802.11 Mode	<p>Select 802.11b Only to allow only IEEE 802.11b compliant WLAN devices to associate with the Device.</p> <p>Select 802.11g Only to allow only IEEE 802.11g compliant WLAN devices to associate with the Device.</p> <p>Select 802.11n Only to allow only IEEE 802.11n compliant WLAN devices to associate with the Device.</p> <p>Select 802.11b/g Mixed to allow either IEEE 802.11b or IEEE 802.11g compliant WLAN devices to associate with the Device. The transmission rate of your Device might be reduced.</p> <p>Select 802.11b/g/n Mixed to allow IEEE 802.11b, IEEE 802.11g or IEEE802.11n compliant WLAN devices to associate with the Device. The transmission rate of your Device might be reduced.</p>
802.11 Protection	<p>Enabling this feature can help prevent collisions in mixed-mode networks (networks with both IEEE 802.11b and IEEE 802.11g traffic).</p> <p>Select Auto to have the wireless devices transmit data after a RTS/CTS handshake. This helps improve IEEE 802.11g performance.</p> <p>Select Off to disable 802.11 protection. The transmission rate of your Device might be reduced in a mixed-mode network.</p> <p>This field displays Off and is not configurable when you set 802.11 Mode to 802.11b Only.</p>
Preamble	<p>Select a preamble type from the drop-down list box. Choices are Long or Short. See Section 7.10.7 on page 117 for more information.</p> <p>This field is configurable only when you set 802.11 Mode to 802.11b.</p>
Apply	Click Apply to save your changes.
Cancel	Click Cancel to restore your previously saved settings.

7.9 The Channel Status Screen

Use the **Channel Status** screen to scan wireless LAN channel noises and view the results. Click **Network Setting > Wireless > Channel Status**. The screen appears as shown. Click **Scan** to scan the wireless LAN channels. You can view the results in the **Channel Scan Result** section.

Note: The **Scan** button only works when the Device uses 20MHz for the wireless channel width. You can go to the **Network Setting > Wireless > General** screen, click the **more** link, and then change the channel width setting in the **Bandwidth** field.

Figure 43 Network Setting > Wireless > Channel Status

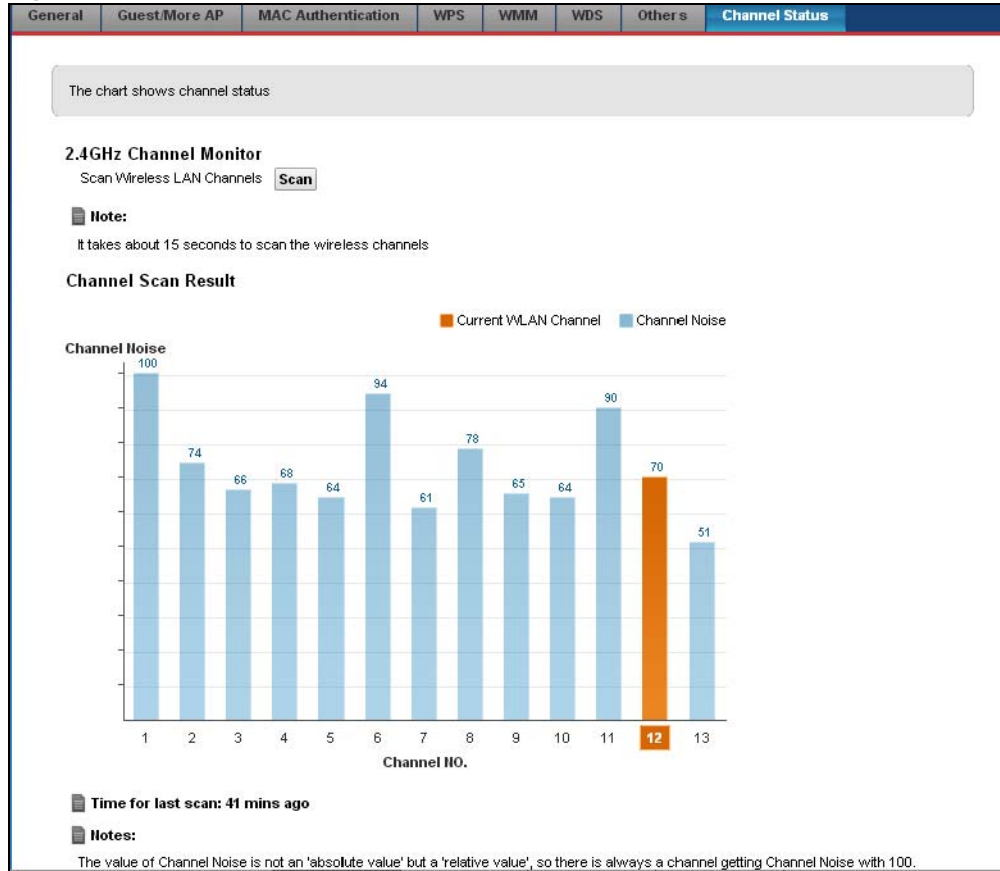

7.10 Technical Reference

This section discusses wireless LANs in depth. For more information, see [Appendix B on page 293](#).

7.10.1 Wireless Network Overview

Wireless networks consist of wireless clients, access points and bridges.

- A wireless client is a radio connected to a user's computer.
- An access point is a radio with a wired connection to a network, which can connect with numerous wireless clients and let them access the network.
- A bridge is a radio that relays communications between access points and wireless clients, extending a network's range.

Traditionally, a wireless network operates in one of two ways.

- An "infrastructure" type of network has one or more access points and one or more wireless clients. The wireless clients connect to the access points.
- An "ad-hoc" type of network is one in which there is no access point. Wireless clients connect to one another in order to exchange information.

The following figure provides an example of a wireless network.

Figure 44 Example of a Wireless Network

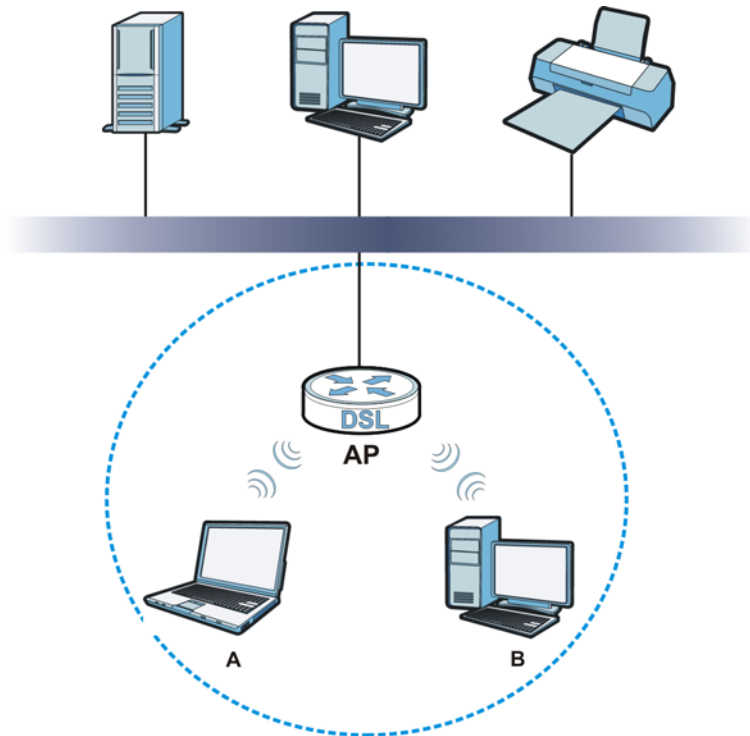

The wireless network is the part in the blue circle. In this wireless network, devices **A** and **B** use the access point (**AP**) to interact with the other devices (such as the printer) or with the Internet. Your Device is the AP.

Every wireless network must follow these basic guidelines.

- Every device in the same wireless network must use the same SSID.
The SSID is the name of the wireless network. It stands for Service Set IDentifier.
- If two wireless networks overlap, they should use a different channel.
Like radio stations or television channels, each wireless network uses a specific channel, or frequency, to send and receive information.
- Every device in the same wireless network must use security compatible with the AP.
Security stops unauthorized devices from using the wireless network. It can also protect the information that is sent in the wireless network.

Radio Channels

In the radio spectrum, there are certain frequency bands allocated for unlicensed, civilian use. For the purposes of wireless networking, these bands are divided into numerous channels. This allows a variety of networks to exist in the same place without interfering with one another. When you create a network, you must select a channel to use.

Since the available unlicensed spectrum varies from one country to another, the number of available channels also varies.

7.10.2 Additional Wireless Terms

The following table describes some wireless network terms and acronyms used in the Device's Web Configurator.

Table 28 Additional Wireless Terms

TERM	DESCRIPTION
RTS/CTS Threshold	<p>In a wireless network which covers a large area, wireless devices are sometimes not aware of each other's presence. This may cause them to send information to the AP at the same time and result in information colliding and not getting through.</p> <p>By setting this value lower than the default value, the wireless devices must sometimes get permission to send information to the Device. The lower the value, the more often the devices must get permission.</p> <p>If this value is greater than the fragmentation threshold value (see below), then wireless devices never have to get permission to send information to the Device.</p>
Preamble	A preamble affects the timing in your wireless network. There are two preamble modes: long and short. If a device uses a different preamble mode than the Device does, it cannot communicate with the Device.
Authentication	The process of verifying whether a wireless device is allowed to use the wireless network.
Fragmentation Threshold	A small fragmentation threshold is recommended for busy networks, while a larger threshold provides faster performance if the network is not very busy.

7.10.3 Wireless Security Overview

By their nature, radio communications are simple to intercept. For wireless data networks, this means that anyone within range of a wireless network without security can not only read the data passing over the airwaves, but also join the network. Once an unauthorized person has access to the network, he or she can steal information or introduce malware (malicious software) intended to compromise the network. For these reasons, a variety of security systems have been developed to ensure that only authorized people can use a wireless data network, or understand the data carried on it.

These security standards do two things. First, they authenticate. This means that only people presenting the right credentials (often a username and password, or a "key" phrase) can access the network. Second, they encrypt. This means that the information sent over the air is encoded. Only people with the code key can understand the information, and only people who have been authenticated are given the code key.

These security standards vary in effectiveness. Some can be broken, such as the old Wired Equivalent Protocol (WEP). Using WEP is better than using no security at all, but it will not keep a determined attacker out. Other security standards are secure in themselves but can be broken if a user does not use them properly. For example, the WPA-PSK security standard is very secure if you use a long key which is difficult for an attacker's software to guess - for example, a twenty-letter long string of apparently random numbers and letters - but it is not very secure if you use a short key which is very easy to guess - for example, a three-letter word from the dictionary.

Because of the damage that can be done by a malicious attacker, it's not just people who have sensitive information on their network who should use security. Everybody who uses any wireless network should ensure that effective security is in place.

A good way to come up with effective security keys, passwords and so on is to use obscure information that you personally will easily remember, and to enter it in a way that appears random

and does not include real words. For example, if your mother owns a 1970 Dodge Challenger and her favorite movie is Vanishing Point (which you know was made in 1971) you could use "70dodchal71vanpoi" as your security key.

The following sections introduce different types of wireless security you can set up in the wireless network.

7.10.3.1 SSID

Normally, the Device acts like a beacon and regularly broadcasts the SSID in the area. You can hide the SSID instead, in which case the Device does not broadcast the SSID. In addition, you should change the default SSID to something that is difficult to guess.

This type of security is fairly weak, however, because there are ways for unauthorized wireless devices to get the SSID. In addition, unauthorized wireless devices can still see the information that is sent in the wireless network.

7.10.3.2 MAC Address Filter

Every device that can use a wireless network has a unique identification number, called a MAC address.¹ A MAC address is usually written using twelve hexadecimal characters²; for example, 00A0C5000002 or 00:A0:C5:00:00:02. To get the MAC address for each device in the wireless network, see the device's User's Guide or other documentation.

You can use the MAC address filter to tell the Device which devices are allowed or not allowed to use the wireless network. If a device is allowed to use the wireless network, it still has to have the correct information (SSID, channel, and security). If a device is not allowed to use the wireless network, it does not matter if it has the correct information.

This type of security does not protect the information that is sent in the wireless network. Furthermore, there are ways for unauthorized wireless devices to get the MAC address of an authorized device. Then, they can use that MAC address to use the wireless network.

7.10.3.3 User Authentication

Authentication is the process of verifying whether a wireless device is allowed to use the wireless network. You can make every user log in to the wireless network before using it. However, every device in the wireless network has to support IEEE 802.1x to do this.

For wireless networks, you can store the user names and passwords for each user in a RADIUS server. This is a server used in businesses more than in homes. If you do not have a RADIUS server, you cannot set up user names and passwords for your users.

Unauthorized wireless devices can still see the information that is sent in the wireless network, even if they cannot use the wireless network. Furthermore, there are ways for unauthorized wireless users to get a valid user name and password. Then, they can use that user name and password to use the wireless network.

-
1. Some wireless devices, such as scanners, can detect wireless networks but cannot use wireless networks. These kinds of wireless devices might not have MAC addresses.
 2. Hexadecimal characters are 0, 1, 2, 3, 4, 5, 6, 7, 8, 9, A, B, C, D, E, and F.

7.10.3.4 Encryption

Wireless networks can use encryption to protect the information that is sent in the wireless network. Encryption is like a secret code. If you do not know the secret code, you cannot understand the message.

The types of encryption you can choose depend on the type of authentication. (See [Section 7.10.3.3 on page 114](#) for information about this.)

Table 29 Types of Encryption for Each Type of Authentication

	NO AUTHENTICATION	RADIUS SERVER
Weakest 	No Security	WPA
	Static WEP	
	WPA-PSK	
Strongest	WPA2-PSK	WPA2

For example, if the wireless network has a RADIUS server, you can choose **WPA** or **WPA2**. If users do not log in to the wireless network, you can choose no encryption, **Static WEP**, **WPA-PSK**, or **WPA2-PSK**.

Usually, you should set up the strongest encryption that every device in the wireless network supports. For example, suppose you have a wireless network with the Device and you do not have a RADIUS server. Therefore, there is no authentication. Suppose the wireless network has two devices. Device A only supports WEP, and device B supports WEP and WPA. Therefore, you should set up **Static WEP** in the wireless network.

Note: It is recommended that wireless networks use **WPA-PSK**, **WPA**, or stronger encryption. The other types of encryption are better than none at all, but it is still possible for unauthorized wireless devices to figure out the original information pretty quickly.

When you select **WPA2** or **WPA2-PSK** in your Device, you can also select an option (**WPA compatible**) to support WPA as well. In this case, if some of the devices support WPA and some support WPA2, you should set up **WPA2-PSK** or **WPA2** (depending on the type of wireless network login) and select the **WPA compatible** option in the Device.

Many types of encryption use a key to protect the information in the wireless network. The longer the key, the stronger the encryption. Every device in the wireless network must have the same key.

7.10.4 Signal Problems

Because wireless networks are radio networks, their signals are subject to limitations of distance, interference and absorption.

Problems with distance occur when the two radios are too far apart. Problems with interference occur when other radio waves interrupt the data signal. Interference may come from other radio transmissions, such as military or air traffic control communications, or from machines that are coincidental emitters such as electric motors or microwaves. Problems with absorption occur when physical objects (such as thick walls) are between the two radios, muffling the signal.

7.10.5 BSS

A Basic Service Set (BSS) exists when all communications between wireless stations or between a wireless station and a wired network client go through one access point (AP).

Intra-BSS traffic is traffic between wireless stations in the BSS. When Intra-BSS traffic blocking is disabled, wireless station A and B can access the wired network and communicate with each other. When Intra-BSS traffic blocking is enabled, wireless station A and B can still access the wired network but cannot communicate with each other.

Figure 45 Basic Service set

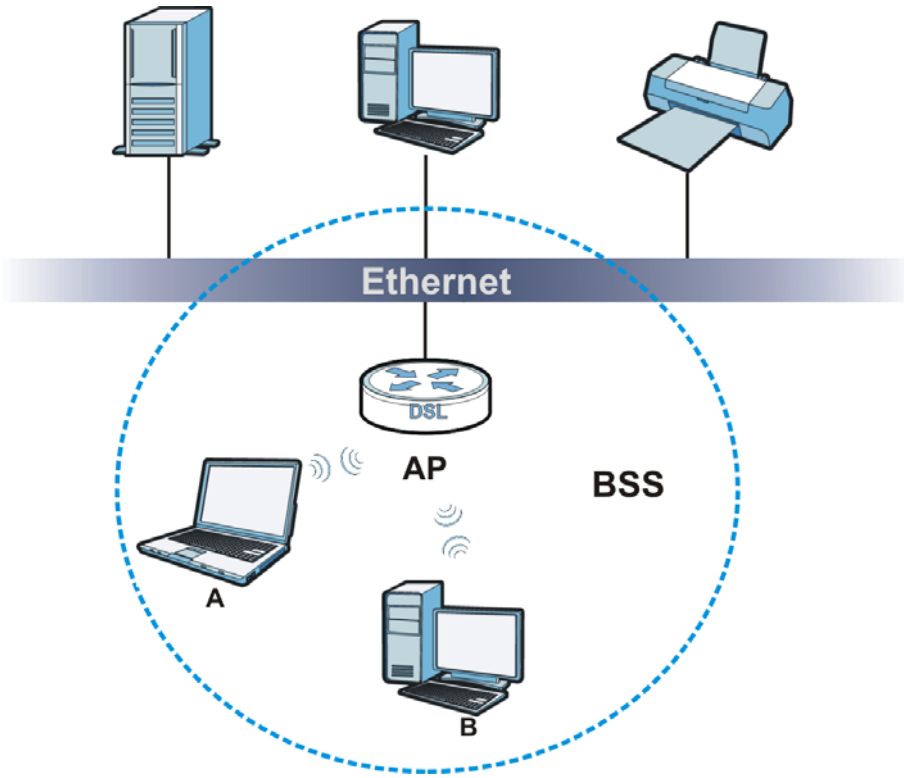

7.10.6 MBSSID

Traditionally, you need to use different APs to configure different Basic Service Sets (BSSs). As well as the cost of buying extra APs, there is also the possibility of channel interference. The Device's MBSSID (Multiple Basic Service Set IDentifier) function allows you to use one access point to provide several BSSs simultaneously. You can then assign varying QoS priorities and/or security modes to different SSIDs.

Wireless devices can use different BSSIDs to associate with the same AP.

7.10.6.1 Notes on Multiple BSSs

- A maximum of eight BSSs are allowed on one AP simultaneously.
- You must use different keys for different BSSs. If two wireless devices have different BSSIDs (they are in different BSSs), but have the same keys, they may hear each other's communications (but not communicate with each other).

- MBSSID should not replace but rather be used in conjunction with 802.1x security.

7.10.7 Preamble Type

Preamble is used to signal that data is coming to the receiver. Short and long refer to the length of the synchronization field in a packet.

Short preamble increases performance as less time sending preamble means more time for sending data. All IEEE 802.11 compliant wireless adapters support long preamble, but not all support short preamble.

Use long preamble if you are unsure what preamble mode other wireless devices on the network support, and to provide more reliable communications in busy wireless networks.

Use short preamble if you are sure all wireless devices on the network support it, and to provide more efficient communications.

Use the dynamic setting to automatically use short preamble when all wireless devices on the network support it, otherwise the Device uses long preamble.

Note: The wireless devices **MUST** use the same preamble mode in order to communicate.

7.10.8 Wireless Distribution System (WDS)

The Device can act as a wireless network bridge and establish WDS (Wireless Distribution System) links with other APs. You need to know the MAC addresses of the APs you want to link to. Once the security settings of peer sides match one another, the connection between devices is made.

At the time of writing, WDS security is compatible with other ZyXEL access points only. Refer to your other access point's documentation for details.

The following figure illustrates how WDS link works between APs. Notebook computer **A** is a wireless client connecting to access point **AP 1**. **AP 1** has no wired Internet connection, but it can establish a WDS link with access point **AP 2**, which has a wired Internet connection. When **AP 1** has a WDS link with **AP 2**, the notebook computer can access the Internet through **AP 2**.

Figure 46 WDS Link Example



7.10.9 WiFi Protected Setup (WPS)

Your Device supports WiFi Protected Setup (WPS), which is an easy way to set up a secure wireless network. WPS is an industry standard specification, defined by the WiFi Alliance.

WPS allows you to quickly set up a wireless network with strong security, without having to configure security settings manually. Each WPS connection works between two devices. Both devices must support WPS (check each device's documentation to make sure).

Depending on the devices you have, you can either press a button (on the device itself, or in its configuration utility) or enter a PIN (a unique Personal Identification Number that allows one device to authenticate the other) in each of the two devices. When WPS is activated on a device, it has two minutes to find another device that also has WPS activated. Then, the two devices connect and set up a secure network by themselves.

7.10.9.1 Push Button Configuration

WPS Push Button Configuration (PBC) is initiated by pressing a button on each WPS-enabled device, and allowing them to connect automatically. You do not need to enter any information.

Not every WPS-enabled device has a physical WPS button. Some may have a WPS PBC button in their configuration utilities instead of or in addition to the physical button.

Take the following steps to set up WPS using the button.

- 1 Ensure that the two devices you want to set up are within wireless range of one another.
- 2 Look for a WPS button on each device. If the device does not have one, log into its configuration utility and locate the button (see the device's User's Guide for how to do this - for the Device, see [Section 7.6 on page 105](#)).
- 3 Press the button on one of the devices (it doesn't matter which). For the Device you must press the WPS button for more than three seconds.
- 4 Within two minutes, press the button on the other device. The registrar sends the network name (SSID) and security key through an secure connection to the enrollee.

If you need to make sure that WPS worked, check the list of associated wireless clients in the AP's configuration utility. If you see the wireless client in the list, WPS was successful.

7.10.9.2 PIN Configuration

Each WPS-enabled device has its own PIN (Personal Identification Number). This may either be static (it cannot be changed) or dynamic (in some devices you can generate a new PIN by clicking on a button in the configuration interface).

Use the PIN method instead of the push-button configuration (PBC) method if you want to ensure that the connection is established between the devices you specify, not just the first two devices to activate WPS in range of each other. However, you need to log into the configuration interfaces of both devices to use the PIN method.

When you use the PIN method, you must enter the PIN from one device (usually the wireless client) into the second device (usually the Access Point or wireless router). Then, when WPS is activated on the first device, it presents its PIN to the second device. If the PIN matches, one device sends the network and security information to the other, allowing it to join the network.

Take the following steps to set up a WPS connection between an access point or wireless router (referred to here as the AP) and a client device using the PIN method.

- 1 Ensure WPS is enabled on both devices.
- 2 Access the WPS section of the AP's configuration interface. See the device's User's Guide for how to do this.

- 3 Look for the client's WPS PIN; it will be displayed either on the device, or in the WPS section of the client's configuration interface (see the device's User's Guide for how to find the WPS PIN - for the Device, see [Section 7.5 on page 103](#)).
- 4 Enter the client's PIN in the AP's configuration interface.
- 5 If the client device's configuration interface has an area for entering another device's PIN, you can either enter the client's PIN in the AP, or enter the AP's PIN in the client - it does not matter which.
- 6 Start WPS on both devices within two minutes.
- 7 Use the configuration utility to activate WPS, not the push-button on the device itself.
- 8 On a computer connected to the wireless client, try to connect to the Internet. If you can connect, WPS was successful.

If you cannot connect, check the list of associated wireless clients in the AP's configuration utility. If you see the wireless client in the list, WPS was successful.

The following figure shows a WPS-enabled wireless client (installed in a notebook computer) connecting to the WPS-enabled AP via the PIN method.

Figure 47 Example WPS Process: PIN Method

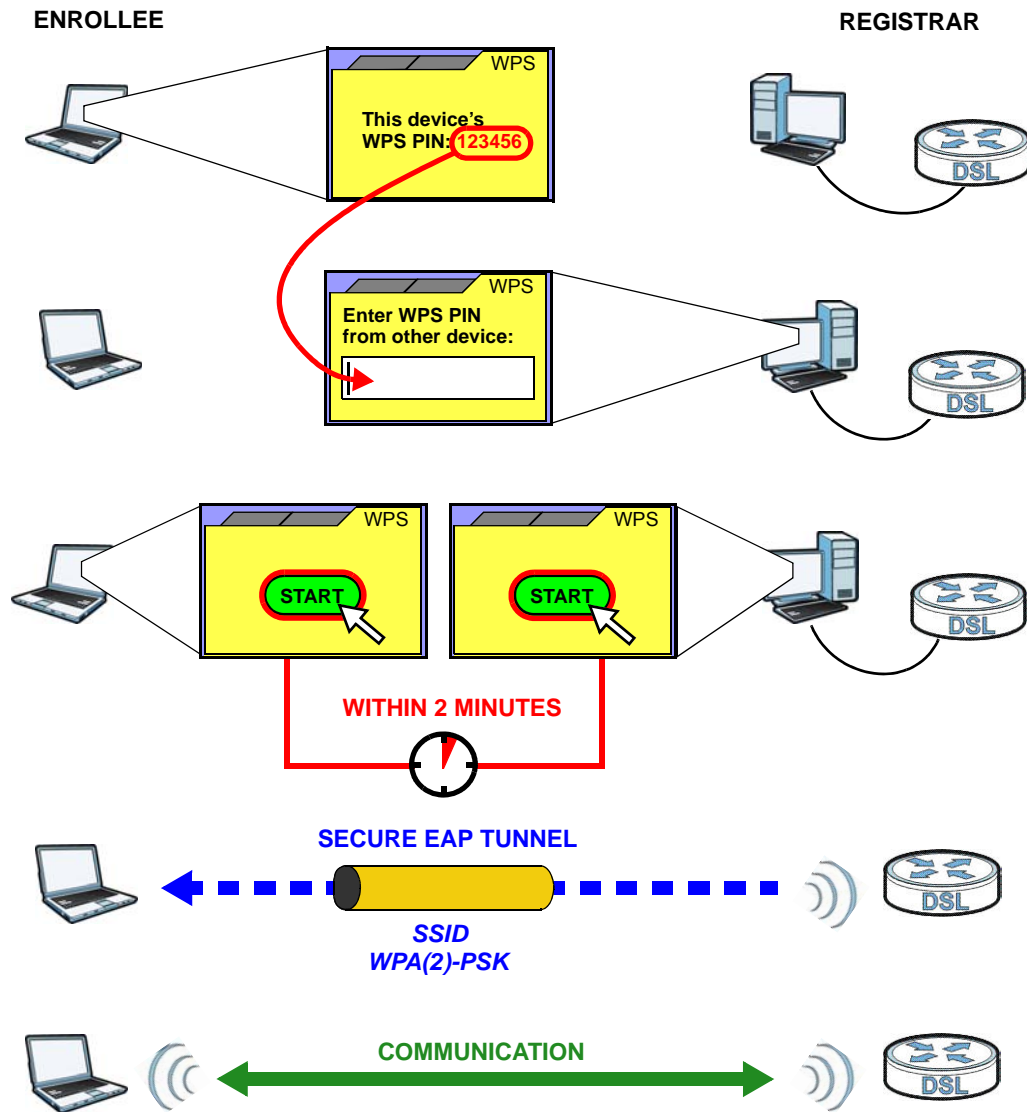

7.10.9.3 How WPS Works

When two WPS-enabled devices connect, each device must assume a specific role. One device acts as the registrar (the device that supplies network and security settings) and the other device acts as the enrollee (the device that receives network and security settings). The registrar creates a secure EAP (Extensible Authentication Protocol) tunnel and sends the network name (SSID) and the WPA-PSK or WPA2-PSK pre-shared key to the enrollee. Whether WPA-PSK or WPA2-PSK is used depends on the standards supported by the devices. If the registrar is already part of a network, it sends the existing information. If not, it generates the SSID and WPA(2)-PSK randomly.

The following figure shows a WPS-enabled client (installed in a notebook computer) connecting to a WPS-enabled access point.

Figure 48 How WPS works

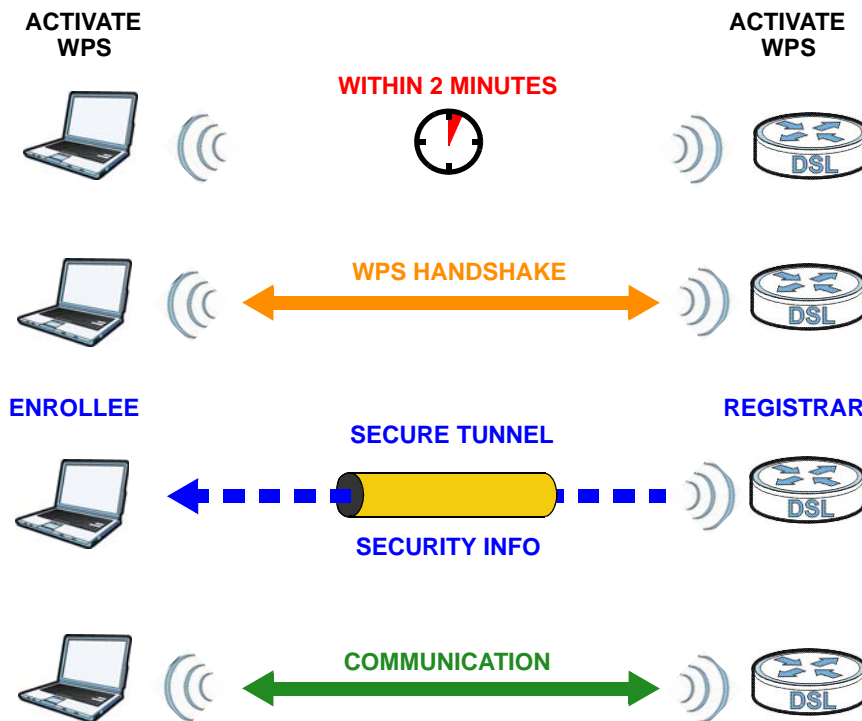

The roles of registrar and enrollee last only as long as the WPS setup process is active (two minutes). The next time you use WPS, a different device can be the registrar if necessary.

The WPS connection process is like a handshake; only two devices participate in each WPS transaction. If you want to add more devices you should repeat the process with one of the existing networked devices and the new device.

Note that the access point (AP) is not always the registrar, and the wireless client is not always the enrollee. All WPS-certified APs can be a registrar, and so can some WPS-enabled wireless clients.

By default, a WPS device is “unconfigured”. This means that it is not part of an existing network and can act as either enrollee or registrar (if it supports both functions). If the registrar is unconfigured, the security settings it transmits to the enrollee are randomly-generated. Once a WPS-enabled device has connected to another device using WPS, it becomes “configured”. A configured wireless client can still act as enrollee or registrar in subsequent WPS connections, but a configured access point can no longer act as enrollee. It will be the registrar in all subsequent WPS connections in which it is involved. If you want a configured AP to act as an enrollee, you must reset it to its factory defaults.

7.10.9.4 Example WPS Network Setup

This section shows how security settings are distributed in an example WPS setup.

The following figure shows an example network. In step 1, both **AP1** and **Client 1** are unconfigured. When WPS is activated on both, they perform the handshake. In this example, **AP1** is the registrar, and **Client 1** is the enrollee. The registrar randomly generates the security information to set up the network, since it is unconfigured and has no existing information.

Figure 49 WPS: Example Network Step 1

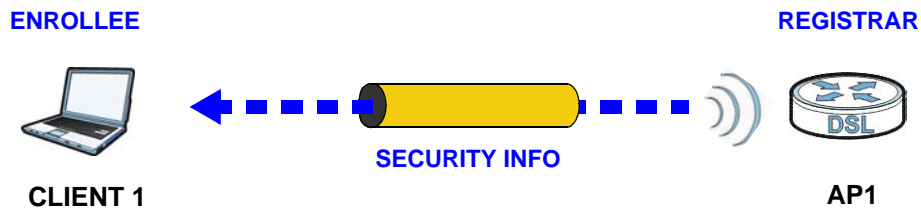

In step 2, you add another wireless client to the network. You know that **Client 1** supports registrar mode, but it is better to use **AP1** for the WPS handshake with the new client since you must connect to the access point anyway in order to use the network. In this case, **AP1** must be the registrar, since it is configured (it already has security information for the network). **AP1** supplies the existing security information to **Client 2**.

Figure 50 WPS: Example Network Step 2

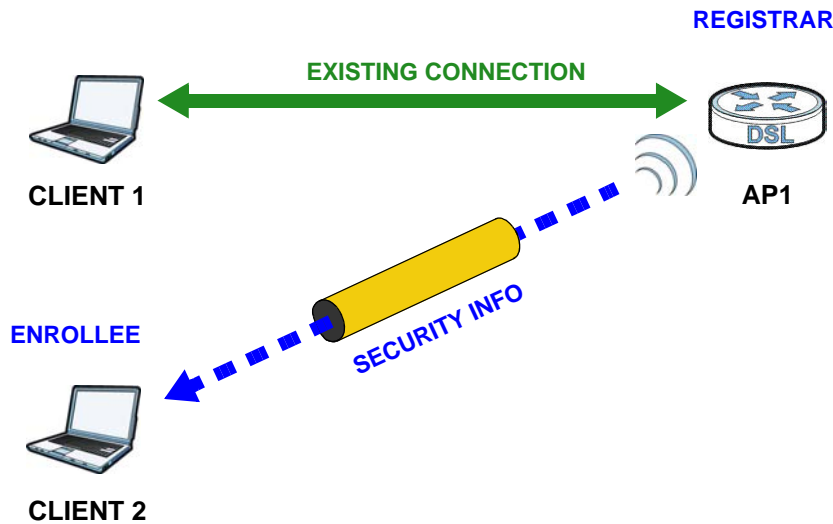

In step 3, you add another access point (**AP2**) to your network. **AP2** is out of range of **AP1**, so you cannot use **AP1** for the WPS handshake with the new access point. However, you know that **Client 2** supports the registrar function, so you use it to perform the WPS handshake instead.

Figure 51 WPS: Example Network Step 3

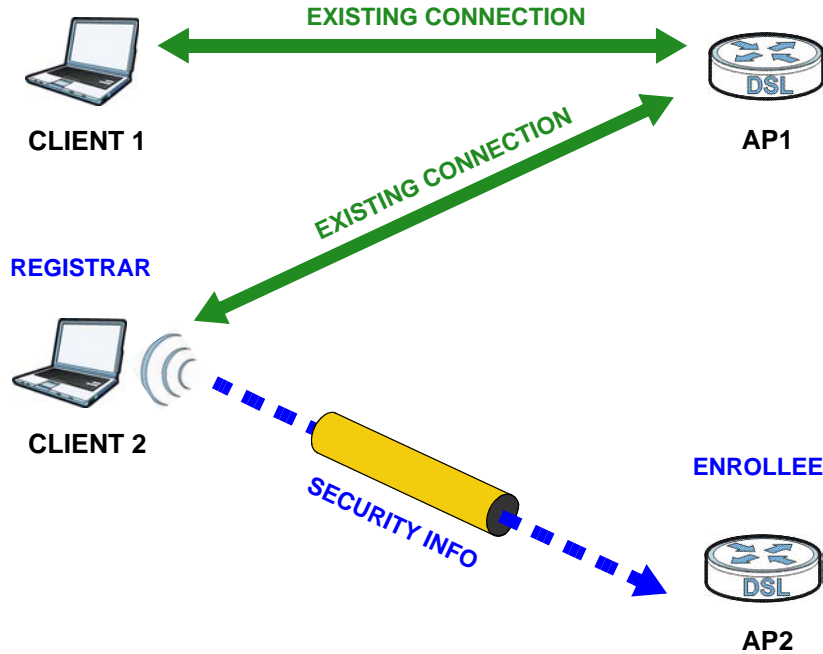

7.10.9.5 Limitations of WPS

WPS has some limitations of which you should be aware.

- WPS works in Infrastructure networks only (where an AP and a wireless client communicate). It does not work in Ad-Hoc networks (where there is no AP).
- When you use WPS, it works between two devices only. You cannot enroll multiple devices simultaneously, you must enroll one after the other.

For instance, if you have two enrollees and one registrar you must set up the first enrollee (by pressing the WPS button on the registrar and the first enrollee, for example), then check that it successfully enrolled, then set up the second device in the same way.

- WPS works only with other WPS-enabled devices. However, you can still add non-WPS devices to a network you already set up using WPS.

WPS works by automatically issuing a randomly-generated WPA-PSK or WPA2-PSK pre-shared key from the registrar device to the enrollee devices. Whether the network uses WPA-PSK or WPA2-PSK depends on the device. You can check the configuration interface of the registrar device to discover the key the network is using (if the device supports this feature). Then, you can enter the key into the non-WPS device and join the network as normal (the non-WPS device must also support WPA-PSK or WPA2-PSK).

- When you use the PBC method, there is a short period (from the moment you press the button on one device to the moment you press the button on the other device) when any WPS-enabled device could join the network. This is because the registrar has no way of identifying the “correct” enrollee, and cannot differentiate between your enrollee and a rogue device. This is a possible way for a hacker to gain access to a network.

You can easily check to see if this has happened. WPS works between only two devices simultaneously, so if another device has enrolled your device will be unable to enroll, and will not have access to the network. If this happens, open the access point’s configuration interface and look at the list of associated clients (usually displayed by MAC address). It does not matter if the

access point is the WPS registrar, the enrollee, or was not involved in the WPS handshake; a rogue device must still associate with the access point to gain access to the network. Check the MAC addresses of your wireless clients (usually printed on a label on the bottom of the device). If there is an unknown MAC address you can remove it or reset the AP.

Home Networking

8.1 Overview

A Local Area Network (LAN) is a shared communication system to which many networking devices are connected. It is usually located in one immediate area such as a building or floor of a building.

Use the LAN screens to help you configure a LAN DHCP server and manage IP addresses.

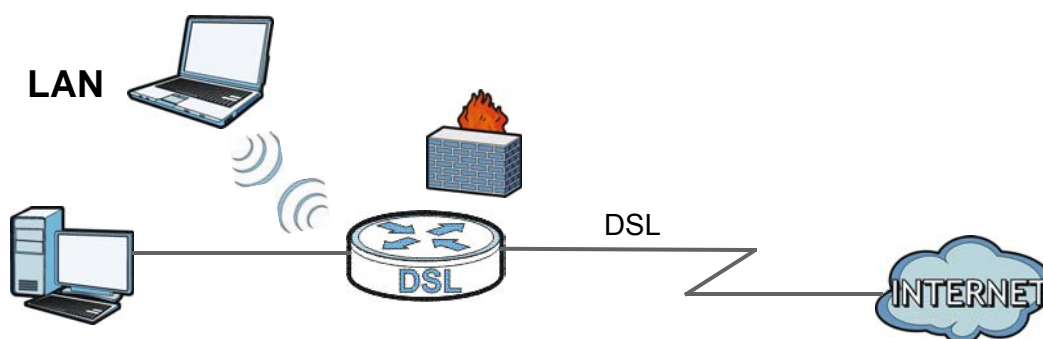

8.1.1 What You Can Do in this Chapter

- Use the **LAN Setup** screen to set the LAN IP address, subnet mask, and DHCP settings of your Device ([Section 8.2 on page 127](#)).
- Use the **Static DHCP** screen to assign IP addresses on the LAN to specific individual computers based on their MAC Addresses ([Section 8.3 on page 131](#)).
- Use the **UPnP** screen to enable UPnP and UPnP NAT traversal on the Device ([Section 8.4 on page 132](#)).
- Use the **Additional Subnet** screen to configure IP alias and public static IP ([Section 8.5 on page 135](#)).
- Use the **STB Vendor ID** screen to have the Device automatically create static DHCP entries for Set Top Box (STB) devices when they request IP addresses ([Section 8.6 on page 136](#)).
- Use the **TFTP Server** screen to identify a TFTP server for configuration file download using DHCP option 66. ([Section 8.7 on page 137](#)).

8.1.2 What You Need To Know

8.1.2.1 About LAN

IP Address

IP addresses identify individual devices on a network. Every networking device (including computers, servers, routers, printers, etc.) needs an IP address to communicate across the network. These networking devices are also known as hosts.

Subnet Mask

Subnet masks determine the maximum number of possible hosts on a network. You can also use subnet masks to divide one network into multiple sub-networks.

DHCP

A DHCP (Dynamic Host Configuration Protocol) server can assign your Device an IP address, subnet mask, DNS and other routing information when it's turned on.

DNS

DNS (Domain Name System) is for mapping a domain name to its corresponding IP address and vice versa. The DNS server is extremely important because without it, you must know the IP address of a networking device before you can access it.

RADVD (Router Advertisement Daemon)

When an IPv6 host sends a Router Solicitation (RS) request to discover the available routers, RADVD with Router Advertisement (RA) messages in response to the request. It specifies the minimum and maximum intervals of RA broadcasts. RA messages containing the address prefix. IPv6 hosts can be generated with the IPv6 prefix an IPv6 address.

8.1.2.2 About UPnP

Identifying UPnP Devices

UPnP hardware is identified as an icon in the Network Connections folder (Windows XP). Each UPnP compatible device installed on your network will appear as a separate icon. Selecting the icon of a UPnP device will allow you to access the information and properties of that device.

NAT Traversal

UPnP NAT traversal automates the process of allowing an application to operate through NAT. UPnP network devices can automatically configure network addressing, announce their presence in the network to other UPnP devices and enable exchange of simple product and service descriptions. NAT traversal allows the following:

- Dynamic port mapping
- Learning public IP addresses

- Assigning lease times to mappings

Windows Messenger is an example of an application that supports NAT traversal and UPnP.

See the [Chapter 11 on page 165](#) for more information on NAT.

Cautions with UPnP

The automated nature of NAT traversal applications in establishing their own services and opening firewall ports may present network security issues. Network information and configuration may also be obtained and modified by users in some network environments.

When a UPnP device joins a network, it announces its presence with a multicast message. For security reasons, the Device allows multicast messages on the LAN only.

All UPnP-enabled devices may communicate freely with each other without additional configuration. Disable UPnP if this is not your intention.

UPnP and ZyXEL

ZyXEL has achieved UPnP certification from the Universal Plug and Play Forum UPnP™ Implementers Corp. (UIC). ZyXEL's UPnP implementation supports Internet Gateway Device (IGD) 1.0.

See [Section 8.4.1 on page 133](#) for examples of installing and using UPnP.

Finding Out More

See [Section 8.8 on page 138](#) for technical background information on LANs.

8.1.3 Before You Begin

Find out the MAC addresses of your network devices if you intend to add them to the DHCP Client List screen.

8.2 The LAN Setup Screen

Use this screen to set the Local Area Network IP address and subnet mask of your Device. Click **Network Setting > Home Networking** to open the **LAN Setup** screen.

Follow these steps to configure your LAN settings.

- 1 Enter an IP address into the **IP Address** field. The IP address must be in dotted decimal notation. This will become the IP address of your Device.
- 2 Enter the IP subnet mask into the **IP Subnet Mask** field. Unless instructed otherwise it is best to leave this alone, the configurator will automatically compute a subnet mask based upon the IP address you entered.

- 3 Click **Apply** to save your settings.

Figure 52 Network Setting > Home Networking > LAN Setup

The following table describes the fields in this screen.

Table 30 Network Setting > Home Networking > LAN Setup

LABEL	DESCRIPTION
Interface Group	
Group Name	Select the interface group name for which you want to configure LAN settings. See Chapter 15 on page 191 for how to create a new interface group.
LAN IP Setup	
IPv4 Address	Enter the LAN IPv4 IP address you want to assign to your Device in dotted decimal notation, for example, 192.168.1.1 (factory default).
Subnet Mask/Prefix Length	Type the subnet mask of your network in dotted decimal notation, for example 255.255.255.0 (factory default). Your Device automatically computes the subnet mask based on the IP Address you enter, so do not change this field unless you are instructed to do so.
IGMP Snooping	
Status	Select the Enable IGMP Snooping checkbox to allows the Device to passively learn multicast group.
IGMP Mode	Select Standard Mode to have the Device forward multicast packets to a port that joins the multicast group and broadcast unknown multicast packets from the WAN to all LAN ports. Select Blocking Mode to have the Device block all unknown multicast packets from the WAN.
DHCP Server State	
DHCP	Select Enable to have the Device act as a DHCP server or DHCP relay agent. Select Disable to stop the DHCP server on the Device. Select DHCP Relay to have the Device forward DHCP request to the DHCP server.

Table 30 Network Setting > Home Networking > LAN Setup (continued)

LABEL	DESCRIPTION
DHCP Relay Server Address	This field is only available when you select DHCP Relay in the DHCP field.
IPv4 Address	Enter the IPv4 IP address of the actual remote DHCP server in this field.
IP Addressing Values	This field is only available when you select Enable in the DHCP field.
Beginning IP Address	This field specifies the first of the contiguous addresses in the IP address pool.
Ending IP Address	This field specifies the last of the contiguous addresses in the IP address pool.
Auto reserve IP for the same host	Select Enable to have the Device record DHCP IP addresses with the MAC addresses the IP addresses are assigned to. The Device assigns the same IP address to the same MAC address when the host requests an IP address again through DHCP.
DHCP Server Lease Time	This is the period of time DHCP-assigned addresses is used. DHCP automatically assigns IP addresses to clients when they log in. DHCP centralizes IP address management on central computers that run the DHCP server program. DHCP leases addresses, for a period of time, which means that past addresses are "recycled" and made available for future reassignment to other systems. This field is only available when you select Enable in the DHCP field.
Days/Hours/Minutes	Enter the lease time of the DHCP server.
DNS Values	This field is only available when you select Enable in the DHCP field.
DNS	Select the type of service that you are registered for from your Dynamic DNS service provider. Select Dynamic if you have the Dynamic DNS service. Select Static if you have the Static DNS service.
DNS Server 1 DNS Server 2	Enter the first and second DNS (Domain Name System) server IP address the Device passes to the DHCP clients.
LAN IPv6 Mode Setup	
IPv6 State	Select Enable to activate the IPv6 mode and configure IPv6 settings on the Device.
LAN IPv6 Address Setup	
Delegate prefix from WAN	Select this option to automatically obtain an IPv6 network prefix from the service provider or an uplink router.
Static	Select this option to configure a fixed IPv6 address for the Device's LAN IPv6 address.
ULA Pseudo-Random Global ID	A unique local address (ULA) is a unique IPv6 address for use in private networks but not routable in the global IPv6 Internet. Select this to have the Device automatically generate a globally unique address for the LAN IPv6 address. The address format is like fdxx:xxxx:xxxx:xxxx:./64.
ULA IPv6 Address Setup	
IPv6 Address	If you select static IPv6 address, enter the IPv6 address prefix that the Device uses for the LAN IPv6 address.
Prefix Length	If you select static IPv6 address, enter the IPv6 prefix length that the Device uses to generate the LAN IPv6 address. An IPv6 prefix length specifies how many most significant bits (starting from the left) in the address compose the network address. This field displays the bit number of the IPv6 subnet mask.

Table 30 Network Setting > Home Networking > LAN Setup (continued)

LABEL	DESCRIPTION
MLD Snooping	Multicast Listener Discovery (MLD) allows an IPv6 switch or router to discover the presence of MLD hosts who wish to receive multicast packets and the IP addresses of multicast groups the hosts want to join on its network. Select Enable MLD Snooping to activate MLD Snooping on the Device. This allows the Device to check MLD packets passing through it and learn the multicast group membership. It helps reduce multicast traffic.
MLD Mode	Select Standard Mode to have the Device forward IPv6 multicast packets to a port that joins the IPv6 multicast group and broadcast unknown IPv6 multicast packets from the WAN to all LAN ports. Select Blocking Mode to have the Device block all unknown IPv6 multicast packets from the WAN.
LAN IPv6 Address Assign Setup	Select how you want to obtain an IPv6 address: <ul style="list-style-type: none"> • Stateless: The Device uses IPv6 stateless autoconfiguration. RADVD (Router Advertisement Daemon) is enabled to have the Device send IPv6 prefix information in router advertisements periodically and in response to router solicitations. DHCPv6 server is disabled. • Stateful: The Device uses IPv6 stateful autoconfiguration. The DHCPv6 server is enabled to have the Device act as a DHCPv6 server and pass IPv6 addresses to DHCPv6 clients. • Stateless and Stateful: The Device uses both IPv6 stateless and stateful autoconfiguration. The LAN IPv6 clients can obtain IPv6 addresses either through router advertisements or through DHCPv6.
LAN IPv6 DNS Assign Setup	Select how the Device provide DNS server and domain name information to the clients: <ul style="list-style-type: none"> • From Router Advertisement: The Device provides DNS information through router advertisements. • From DHCPv6 Server: The Device provides DNS information through DHCPv6. • From RA & DHCPv6 Server: The Device provides DNS information through both router advertisements and DHCPv6.
DHCPv6 Configuration	
DHCPv6 State	This shows the status of the DHCPv6.
IPv6 Router Advertisement State	
RADVD State	This shows whether RADVD is enabled or not.
IPv6 DNS Values	
IPv6 DNS Server 1-3	Select From ISP if your ISP dynamically assigns IPv6 DNS server information. Select User-Defined if you have the IPv6 address of a DNS server. Enter the DNS server IPv6 addresses the Device passes to the DHCP clients. Select None if you do not want to configure IPv6 DNS servers.
DNS Query Scenario	Select how the Device handles clients' DNS information requests. <ul style="list-style-type: none"> • IPv4/IPv6 DNS Server: The Device forwards the requests to both the IPv4 and IPv6 DNS servers and sends clients the first DNS information it receives. • IPv6 DNS Server Only: The Device forwards the requests to the IPv6 DNS server and sends clients the DNS information it receives. • IPv4 DNS Server Only: The Device forwards the requests to the IPv4 DNS server and sends clients the DNS information it receives. • IPv6 DNS Server First: The Device forwards the requests to the IPv6 DNS server first and then the IPv4 DNS server. Then it sends clients the first DNS information it receives. • IPv4 DNS Server First: The Device forwards the requests to the IPv4 DNS server first and then the IPv6 DNS server. Then it sends clients the first DNS information it receives.
Apply	Click Apply to save your changes.
Cancel	Click Cancel to restore your previously saved settings.

8.3 The Static DHCP Screen

This table allows you to assign IP addresses on the LAN to specific individual computers based on their MAC Addresses.

Every Ethernet device has a unique MAC (Media Access Control) address. The MAC address is assigned at the factory and consists of six pairs of hexadecimal characters, for example, 00:A0:C5:00:00:02.

Use this screen to change your Device's static DHCP settings. Click **Network Setting > Home Networking > Static DHCP** to open the following screen.

Figure 53 Network Setting > Home Networking > Static DHCP

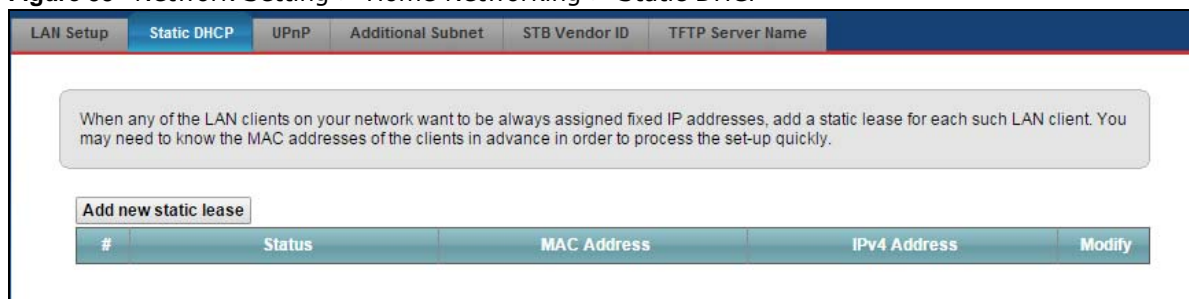

The following table describes the labels in this screen.

Table 31 Network Setting > Home Networking > Static DHCP

LABEL	DESCRIPTION
Add new static lease	Click this to add a new static DHCP entry.
#	This is the index number of the entry.
Status	This field displays whether the client is connected to the Device.
MAC Address	The MAC (Media Access Control) or Ethernet address on a LAN (Local Area Network) is unique to your computer (six pairs of hexadecimal notation). A network interface card such as an Ethernet adapter has a hardwired address that is assigned at the factory. This address follows an industry standard that ensures no other adapter has a similar address.
IP Address	This field displays the IP address relative to the # field listed above.
Modify	Click the Edit icon to have the IP address field editable and change it. Click the Delete icon to delete a static DHCP entry. A window displays asking you to confirm that you want to delete the selected entry.

If you click **Add new static lease** in the **Static DHCP** screen or the Edit icon next to a static DHCP entry, the following screen displays.

Figure 54 Static DHCP: Add/Edit

The following table describes the labels in this screen.

Table 32 Static DHCP: Add/Edit

LABEL	DESCRIPTION
Active	Select this to activate the connection between the client and the Device.
Group Name	Select the interface group name for which you want to configure static DHCP settings. See Chapter 15 on page 191 for how to create a new interface group.
Select Device Info	Select a device or computer from the drop-down list or select Manual Input to manually enter a device's MAC address and IP address in the following fields.
MAC Address	If you select Manual Input , enter the MAC address of a computer on your LAN.
IP Address	If you select Manual Input , enter the IP address that you want to assign to the computer on your LAN with the MAC address that you will also specify.
Apply	Click Apply to save your changes.
Cancel	Click Cancel to exit this screen without saving.

8.4 The UPnP Screen

Universal Plug and Play (UPnP) is a distributed, open networking standard that uses TCP/IP for simple peer-to-peer network connectivity between devices. A UPnP device can dynamically join a network, obtain an IP address, convey its capabilities and learn about other devices on the network. In turn, a device can leave a network smoothly and automatically when it is no longer in use.

See [page 126](#) for more information on UPnP.

Use the following screen to configure the UPnP settings on your Device. Click **Network Setting > Home Networking > UPnP** to display the screen shown next.

Figure 55 Network Setting > Home Networking > UPnP

The following table describes the labels in this screen.

Table 33 Network Setting > Home Networking > UPnP

LABEL	DESCRIPTION
UPnP	Select Enable to activate UPnP. Be aware that anyone could use a UPnP application to open the web configurator's login screen without entering the Device's IP address (although you must still enter the password to access the web configurator).
UPnP NAT-T	Select Enable to allow UPnP-enabled applications to automatically configure the Device so that they can communicate through the Device by using NAT traversal. UPnP applications automatically reserve a NAT forwarding port in order to communicate with another UPnP enabled device; this eliminates the need to manually configure port forwarding for the UPnP enabled application. The table below displays the NAT port forwarding rules added automatically by UPnP NAT-T.
#	This is the index number of the UPnP NAT-T connection.
Description	This is the description of the UPnP NAT-T connection.
IP Address	This is the IP address of the other connected UPnP enabled device.
External Port	This is the external port number that identifies the service.
Internal Port	This is the internal port number that identifies the service.
Apply	Click Apply to save your changes.
Cancel	Click Cancel to exit this screen without saving.

8.4.1 Turning On UPnP in Windows 7 Example

This section shows you how to use the UPnP feature in Windows 7. UPnP server is installed in Windows 7. Activate UPnP on the Device.

Make sure the computer is connected to a LAN port of the Device. Turn on your computer and the Device.

- 1 Click the start icon, **Control Panel** and then the **Network and Sharing Center**.

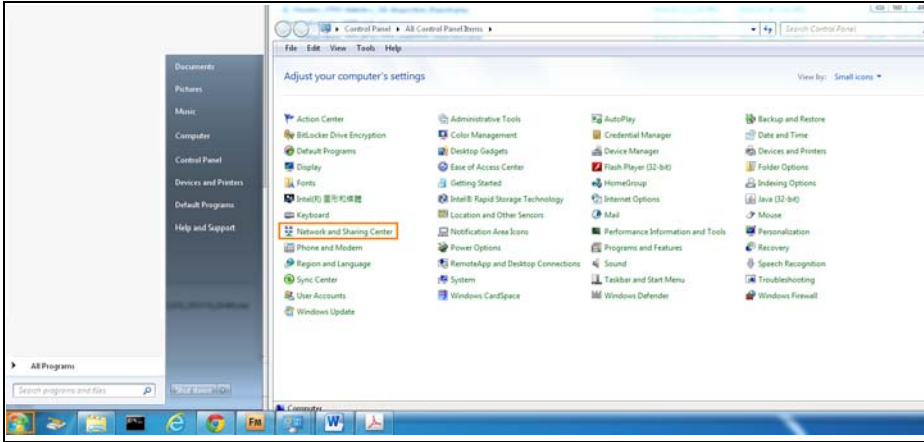

2 Click **Change Advanced Sharing Settings**.

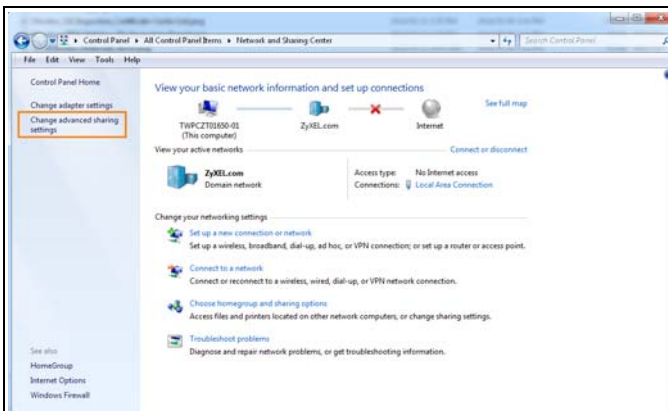

3 Select **Turn on network discovery** and click **Save Changes**. Network discovery allows your computer to find other computers and devices on the network and other computers on the network to find your computer. This makes it easier to share files and printers.

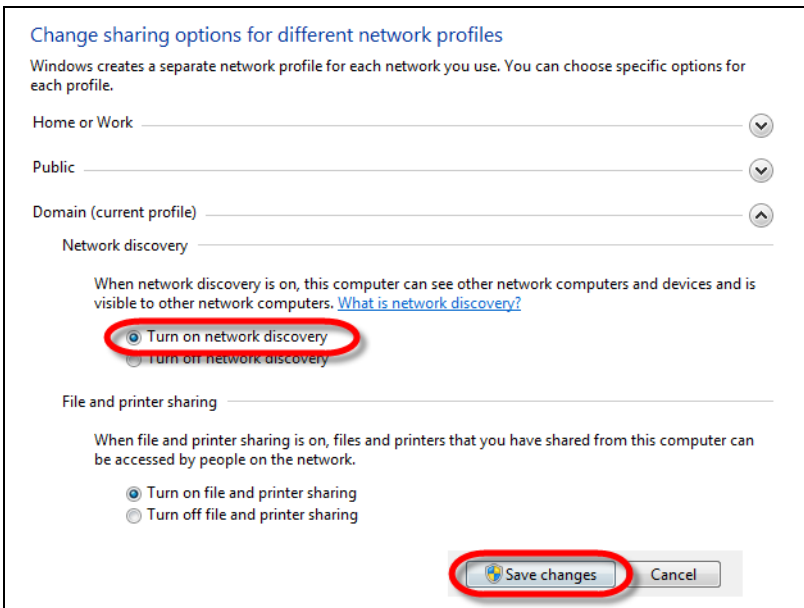

8.5 The Additional Subnet Screen

Use the **Additional Subnet** screen to configure IP alias and public static IP.

IP alias allows you to partition a physical network into different logical networks over the same Ethernet interface. The Device supports multiple logical LAN interfaces via its physical Ethernet interface with the Device itself as the gateway for the LAN network. When you use IP alias, you can also configure firewall rules to control access to the LAN's logical network (subnet).

If your ISP provides the Public LAN service, the Device may use an LAN IP address that can be accessed from the WAN.

Click **Network Setting > Home Networking > Additional Subnet** to display the screen shown next.

Figure 56 Network Setting > Home Networking > Additional Subnet

The following table describes the labels in this screen.

Table 34 Network Setting > Home Networking > Additional Subnet

LABEL	DESCRIPTION
IP Alias Setup	
Group Name	Select the interface group name for which you want to configure the IP alias settings. See Chapter 15 on page 191 for how to create a new interface group.
Active	Select the checkbox to configure a LAN network for the Device.
IP Address	Enter the IP address of your Device in dotted decimal notation.
IP Subnet Mask	Your Device will automatically calculate the subnet mask based on the IP address that you assign. Unless you are implementing subnetting, use the subnet mask computed by the Device.
Public LAN	
Active	Select the checkbox to enable the Public LAN feature. Your ISP must support Public LAN and Static IP.
IP Address	Enter the public IP address provided by your ISP.

Table 34 Network Setting > Home Networking > Additional Subnet (continued)

LABEL	DESCRIPTION
IP Subnet Mask	Enter the public IP subnet mask provided by your ISP.
Offer Public IP by DHCP	Select the checkbox to enable the Device to provide public IP addresses by DHCP server.
Enable ARP Proxy	Select the checkbox to enable the ARP (Address Resolution Protocol) proxy.
Apply	Click Apply to save your changes.
Cancel	Click Cancel to exit this screen without saving.

8.6 The STB Vendor ID Screen

Set Top Box (STB) devices with dynamic IP addresses sometimes don't renew their IP addresses before the lease time expires. This could lead to IP address conflicts if the STB continues to use an IP address that gets assigned to another device. Use this screen to view the Vendor IDs of connected STBs and the static DHCP entries that the Device automatically created for them when they requested IP addresses.

Click **Network Setting > Home Networking > STB Vendor ID** to open this screen.

Figure 57 Network Setting > Home Networking > STB Vendor ID

The following table describes the labels in this screen.

Table 35 Network Setting > Home Networking > STB Vendor ID

LABEL	DESCRIPTION
Add New STB Vendor	Click this button to manually create an entry.
Vendor ID	This is an STB's Vendor Class Identifier (DHCP option 60). A Vendor Class Identifier is usually used to inform the DHCP server a DHCP client's vendor and functionality.
DHCP Option	This is the DHCP option 43 value the Device assigns to the STB.
Apply	Click Apply to save your changes.
Cancel	Click Cancel to exit this screen without saving.

8.6.1 The Add/Edit STB Vendor ID Screen

Use this screen to configure an STB's Vendor Class Identifier (DHCP option 60).

Click **Network Setting > Home Networking > STB Vendor ID** to open this screen.

Figure 58 Network Setting > Home Networking > STB Vendor ID

The following table describes the labels in this screen.

Table 36 Network Setting > Home Networking > STB Vendor ID

LABEL	DESCRIPTION
STB Vendor ID	Enter an STB's Vendor Class Identifier which is used for informing the DHCP server the STB's vendor and functionality.
DHCP Option 43	Enter the IP address the Device assigns to the STB. Select HEX if it is a hex string.
Apply	Click Apply to save your changes.
Cancel	Click Cancel to exit this screen without saving.

8.7 The TFTP Server Name Screen

Use the **TFTP Server** screen to identify a TFTP server for configuration file download using DHCP option 66. RFC 2132 defines the option 66 open standard. DHCP option 66 supports the IP address or the hostname of a single TFTP server.

Click **Network Setting > Home Networking > TFTP Server Name** to open this screen.

Figure 59 Network Setting > Home Networking > TFTP Server Name

The following table describes the labels in this screen.

Table 37 Network Setting > Home Networking > TFTP Server Name

LABEL	DESCRIPTION
TFTP Server Name	Enter the the IP address or the hostname of a single TFTP server.
Apply	Click Apply to save your changes.
Cancel	Click Cancel to exit this screen without saving.

8.8 Technical Reference

This section provides some technical background information about the topics covered in this chapter.

8.8.1 LANs, WANs and the Device

The actual physical connection determines whether the Device ports are LAN or WAN ports. There are two separate IP networks, one inside the LAN network and the other outside the WAN network as shown next.

Figure 60 LAN and WAN IP Addresses

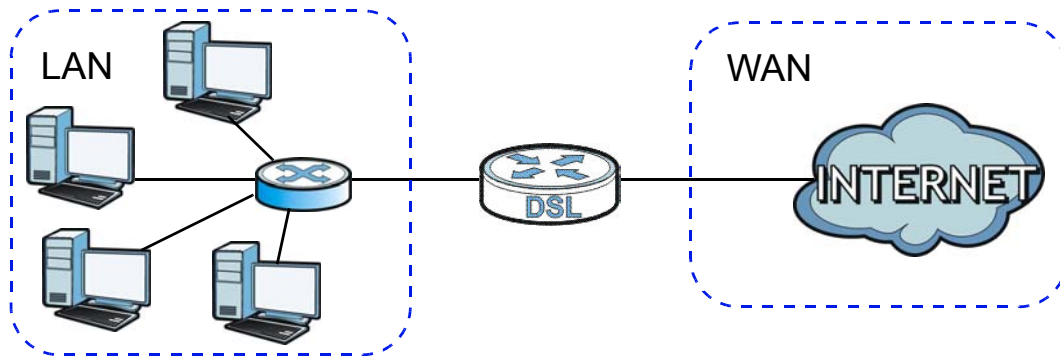

8.8.2 DHCP Setup

DHCP (Dynamic Host Configuration Protocol, RFC 2131 and RFC 2132) allows individual clients to obtain TCP/IP configuration at start-up from a server. You can configure the Device as a DHCP server or disable it. When configured as a server, the Device provides the TCP/IP configuration for the clients. If you turn DHCP service off, you must have another DHCP server on your LAN, or else the computer must be manually configured.

IP Pool Setup

The Device is pre-configured with a pool of IP addresses for the DHCP clients (DHCP Pool). See the product specifications in the appendices. Do not assign static IP addresses from the DHCP pool to your LAN computers.

8.8.3 DNS Server Addresses

DNS (Domain Name System) maps a domain name to its corresponding IP address and vice versa. The DNS server is extremely important because without it, you must know the IP address of a computer before you can access it. The DNS server addresses you enter when you set up DHCP are passed to the client machines along with the assigned IP address and subnet mask.

There are two ways that an ISP disseminates the DNS server addresses.

- The ISP tells you the DNS server addresses, usually in the form of an information sheet, when you sign up. If your ISP gives you DNS server addresses, enter them in the **DNS Server** fields in the **DHCP Setup** screen.

- Some ISPs choose to disseminate the DNS server addresses using the DNS server extensions of IPCP (IP Control Protocol) after the connection is up. If your ISP did not give you explicit DNS servers, chances are the DNS servers are conveyed through IPCP negotiation. The Device supports the IPCP DNS server extensions through the DNS proxy feature.

Please note that DNS proxy works only when the ISP uses the IPCP DNS server extensions. It does not mean you can leave the DNS servers out of the DHCP setup under all circumstances. If your ISP gives you explicit DNS servers, make sure that you enter their IP addresses in the **DHCP Setup** screen.

8.8.4 LAN TCP/IP

The Device has built-in DHCP server capability that assigns IP addresses and DNS servers to systems that support DHCP client capability.

IP Address and Subnet Mask

Similar to the way houses on a street share a common street name, so too do computers on a LAN share one common network number.

Where you obtain your network number depends on your particular situation. If the ISP or your network administrator assigns you a block of registered IP addresses, follow their instructions in selecting the IP addresses and the subnet mask.

If the ISP did not explicitly give you an IP network number, then most likely you have a single user account and the ISP will assign you a dynamic IP address when the connection is established. If this is the case, it is recommended that you select a network number from 192.168.0.0 to 192.168.255.0 and you must enable the Network Address Translation (NAT) feature of the Device. The Internet Assigned Number Authority (IANA) reserved this block of addresses specifically for private use; please do not use any other number unless you are told otherwise. Let's say you select 192.168.1.0 as the network number; which covers 254 individual addresses, from 192.168.1.1 to 192.168.1.254 (zero and 255 are reserved). In other words, the first three numbers specify the network number while the last number identifies an individual computer on that network.

Once you have decided on the network number, pick an IP address that is easy to remember, for instance, 192.168.1.1, for your Device, but make sure that no other device on your network is using that IP address.

The subnet mask specifies the network number portion of an IP address. Your Device will compute the subnet mask automatically based on the IP address that you entered. You don't need to change the subnet mask computed by the Device unless you are instructed to do otherwise.

Private IP Addresses

Every machine on the Internet must have a unique address. If your networks are isolated from the Internet, for example, only between your two branch offices, you can assign any IP addresses to the hosts without problems. However, the Internet Assigned Numbers Authority (IANA) has reserved the following three blocks of IP addresses specifically for private networks:

- 10.0.0.0 — 10.255.255.255
- 172.16.0.0 — 172.31.255.255
- 192.168.0.0 — 192.168.255.255

You can obtain your IP address from the IANA, from an ISP or it can be assigned from a private network. If you belong to a small organization and your Internet access is through an ISP, the ISP can provide you with the Internet addresses for your local networks. On the other hand, if you are part of a much larger organization, you should consult your network administrator for the appropriate IP addresses.

Note: Regardless of your particular situation, do not create an arbitrary IP address; always follow the guidelines above. For more information on address assignment, please refer to RFC 1597, "Address Allocation for Private Internets" and RFC 1466, "Guidelines for Management of IP Address Space".

Routing

9.1 Overview

The Device usually uses the default gateway to route outbound traffic from computers on the LAN to the Internet. To have the Device send data to devices not reachable through the default gateway, use static routes.

For example, the next figure shows a computer (**A**) connected to the Device's LAN interface. The Device routes most traffic from **A** to the Internet through the Device's default gateway (**R1**). You create one static route to connect to services offered by your ISP behind router **R2**. You create another static route to communicate with a separate network behind a router **R3** connected to the LAN.

Figure 61 Example of Routing Topology

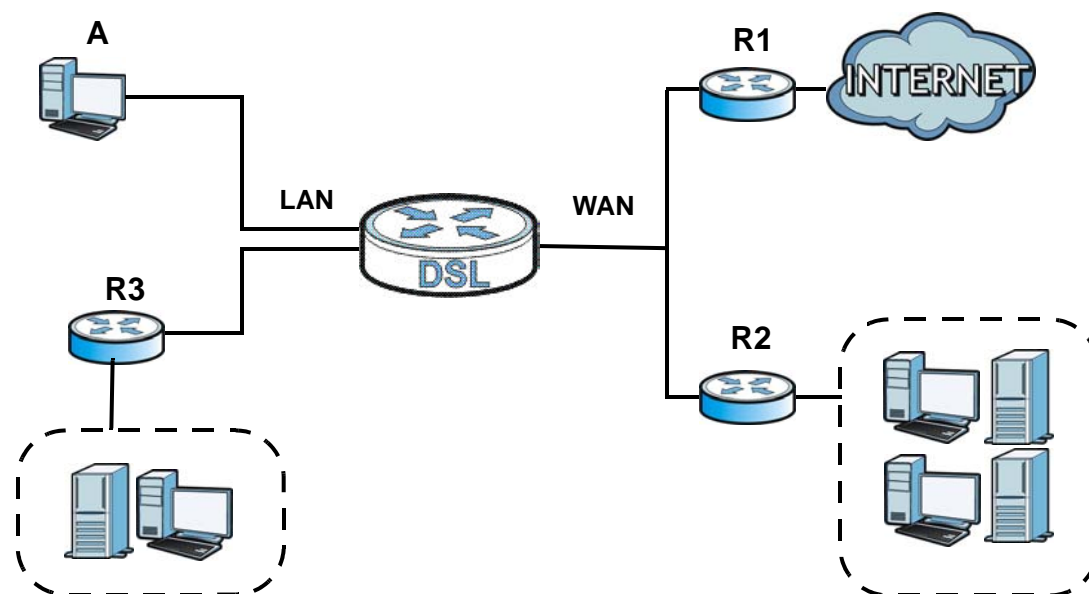

9.2 The Routing Screen

Use this screen to view and configure the static route rules on the Device. Click **Network Setting** > **Routing** > **Static Route** to open the following screen.

Figure 62 Network Setting > Routing > Static Route

Add new Static Route							
#	Status	Name	Destination IP	Subnet Mask/Prefix Length	Gateway	Interface	Modify

The following table describes the labels in this screen.

Table 38 Network Setting > Routing > Static Route

LABEL	DESCRIPTION
Add new static route	Click this to configure a new static route.
#	This is the index number of the entry.
Status	This field displays whether the static route is active or not. A yellow bulb signifies that this route is active. A gray bulb signifies that this route is not active.
Name	This is the name that describes or identifies this route.
Destination IP	This parameter specifies the IP network address of the final destination. Routing is always based on network number.
Subnet Mask	This parameter specifies the IP network subnet mask of the final destination.
Gateway	This is the IP address of the gateway. The gateway is a router or switch on the same network segment as the device's LAN or WAN port. The gateway helps forward packets to their destinations.
Interface	This is the WAN interface used for this static route.
Modify	Click the Edit icon to edit the static route on the Device. Click the Delete icon to remove a static route from the Device. A window displays asking you to confirm that you want to delete the route.

9.2.1 Add/Edit Static Route

Use this screen to add or edit a static route. Click **Add new static route** in the **Routing** screen or the **Edit** icon next to the static route you want to edit. The screen shown next appears.

Figure 63 Routing: Add/Edit

The following table describes the labels in this screen.

Table 39 Routing: Add/Edit

LABEL	DESCRIPTION
Active	This field allows you to activate/deactivate this static route. Select this to enable the static route. Clear this to disable this static route without having to delete the entry.
Route Name	Enter a descriptive name for the static route.
IP Type	Select whether your IP type is IPv4 or IPv6 .
Destination IP Address	Enter the IPv4 or IPv6 network address of the final destination.
IP Subnet Mask	If you are using IPv4 and need to specify a route to a single host, use a subnet mask of 255.255.255.255 in the subnet mask field to force the network number to be identical to the host ID. Enter the IP subnet mask here.
Use Gateway IP Address	The gateway is a router or switch on the same network segment as the device's LAN or WAN port. The gateway helps forward packets to their destinations. If you want to use the gateway IP address, select Enable .
Gateway IP Address	Enter the IP address of the gateway.
Use Interface	Select the WAN interface you want to use for this static route.
Apply	Click Apply to save your changes.
Cancel	Click Cancel to exit this screen without saving.

9.3 The DNS Route Screen

Use this screen to view and configure DNS routes on the Device. Click **Network Setting > Routing > DNS Route** to open the following screen.

Figure 64 Network Setting > Routing > DNS Route

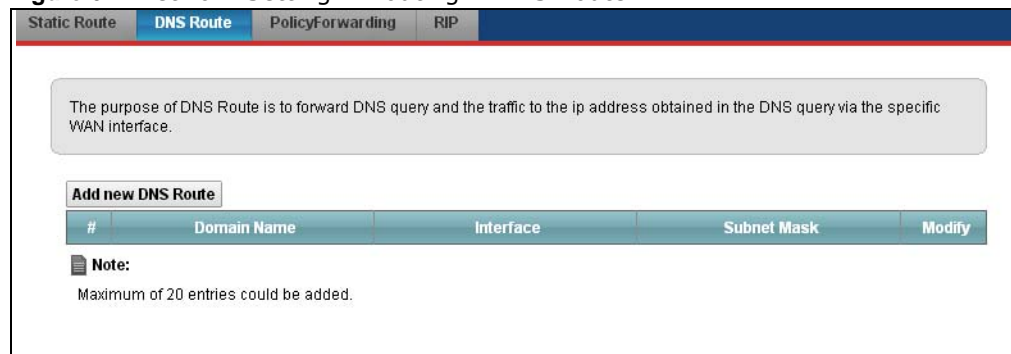

The following table describes the labels in this screen.

Table 40 Network Setting > Routing > DNS Route

LABEL	DESCRIPTION
Add new DNS Route	Click this to add a new DNS route.
#	This is the index number of a DNS route.

Table 40 Network Setting > Routing > DNS Route (continued)

LABEL	DESCRIPTION
Domain Name	This is the host name or domain name of the DNS route entry.
Interface	This is the WAN connection through which the Device forwards DNS requests for this domain name.
Subnet Mask	This is the subnet mask of the DNS route entry.
Modify	Click the Edit icon to modify the DNS route. Click the Delete icon to delete the DNS route.

9.3.1 The DNS Route Add Screen

You can manually add the Device's DNS route entry. Click **Add new DNS Route** in the **Network Setting > Routing > DNS Route** screen. The screen shown next appears.

Figure 65 DNS Route Add

The following table describes the labels in this screen.

Table 41 DNS Route Add

LABEL	DESCRIPTION
Domain Name	Enter the domain name of the DNS route entry.
Interface	Select the WAN connection through which the Device forwards DNS requests for this domain name.
Subnet Mask	Enter the subnet mask of the DNS route entry.
OK	Click this to save your changes.
Cancel	Click this to exit this screen without saving any changes.

9.4 The Policy Forwarding Screen

Traditionally, routing is based on the destination address only and the Device takes the shortest path to forward a packet. Policy forwarding allows the Device to override the default routing behavior and alter the packet forwarding based on the policy defined by the network administrator. Policy-based routing is applied to outgoing packets, prior to the normal routing.

You can use source-based policy forwarding to direct traffic from different users through different connections or distribute traffic among multiple paths for load sharing.

The **Policy Forwarding** screen let you view and configure routing policies on the Device. Click **Network Setting > Routing > Policy Forwarding** to open the following screen.

Figure 66 Network Setting > Routing > Policy Forwarding

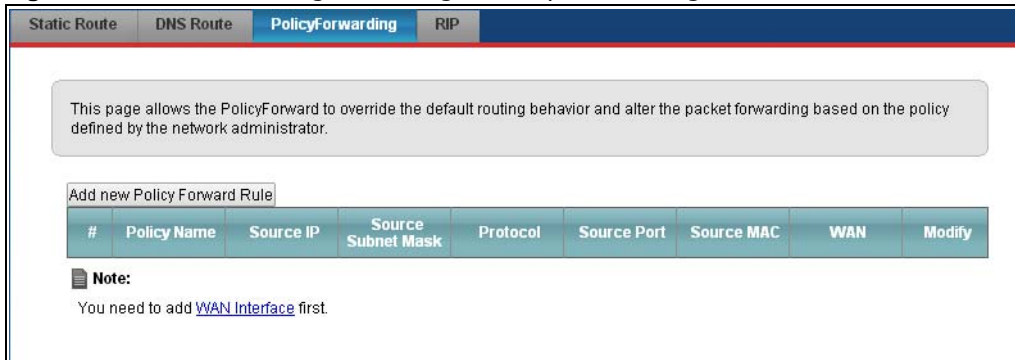

The following table describes the labels in this screen.

Table 42 Network Setting > Routing > Policy Forwarding

LABEL	DESCRIPTION
Add new Policy Forward Rule	Click this to create a new policy forwarding rule.
#	This is the index number of the entry.
Policy Name	This is the name of the rule.
Source IP	This is the source IP address.
Source Subnet Mask	his is the source subnet mask address.
Protocol	This is the transport layer protocol.
Source Port	This is the source port number.
WAN	This is the WAN interface through which the traffic is routed.
Modify	Click the Edit icon to edit this policy. Click the Delete icon to remove a policy from the Device. A window displays asking you to confirm that you want to delete the policy.

9.4.1 Add/Edit Policy Forwarding

Click **Add new Policy Forward Rule** in the **Policy Forwarding** screen or click the **Edit** icon next to a policy. Use this screen to configure the required information for a policy route.

Figure 67 Policy Forwarding: Add/Edit

The following table describes the labels in this screen.

Table 43 Policy Forwarding: Add/Edit

LABEL	DESCRIPTION
Policy Name	Enter a descriptive name of up to 8 printable English keyboard characters, not including spaces.
Source IP	Enter the source IP address.
Source Subnet Mask	Enter the source subnet mask address.
Protocol	Select the transport layer protocol (TCP or UDP).
Source Port	Enter the source port number.
Source MAC	Enter the source MAC address.
WAN	Select a WAN interface through which the traffic is sent. You must have the WAN interface(s) already configured in the Broadband screens.
Apply	Click Apply to save your changes.
Cancel	Click Cancel to exit this screen without saving.

9.5 RIP

Routing Information Protocol (RIP, RFC 1058 and RFC 1389) allows a device to exchange routing information with other routers.

9.5.1 The RIP Screen

Click **Network Setting > Routing > RIP** to open the **RIP** screen.

Figure 68 RIP

To activate RIP for the WAN Interface, select the desired RIP version and operation and place a check in the Enable checkbox. To stop RIP on the WAN Interface, uncheck the Enable checkbox. Click the Apply button to start/stop RIP and save the configuration.

#	Interface	Version	Operation	Enable	Disable Default Gateway
1	Default	2	Passive	<input type="checkbox"/>	<input type="checkbox"/>

Apply Cancel

The following table describes the labels in this screen.

Table 44 RIP

LABEL	DESCRIPTION
#	This is the index of the interface in which the RIP setting is used.
Interface	This is the name of the interface in which the RIP setting is used.
Version	The RIP version controls the format and the broadcasting method of the RIP packets that the Device sends (it recognizes both formats when receiving). RIP version 1 is universally supported but RIP version 2 carries more information. RIP version 1 is probably adequate for most networks, unless you have an unusual network topology.
Operation	Select Passive to have the Device update the routing table based on the RIP packets received from neighbors but not advertise its route information to other routers in this interface. Select Active to have the Device advertise its route information and also listen for routing updates from neighboring routers.
Enabled	Select the check box to activate the settings.
Apply	Click Apply to save your changes back to the Device.

Quality of Service (QoS)

10.1 Overview

Quality of Service (QoS) refers to both a network's ability to deliver data with minimum delay, and the networking methods used to control the use of bandwidth. Without QoS, all traffic data is equally likely to be dropped when the network is congested. This can cause a reduction in network performance and make the network inadequate for time-critical application such as video-on-demand.

Configure QoS on the Device to group and prioritize application traffic and fine-tune network performance. Setting up QoS involves these steps:

- 1 Configure classifiers to sort traffic into different flows.
- 2 Assign priority and define actions to be performed for a classified traffic flow.

The Device assigns each packet a priority and then queues the packet accordingly. Packets assigned a high priority are processed more quickly than those with low priority if there is congestion, allowing time-sensitive applications to flow more smoothly. Time-sensitive applications include both those that require a low level of latency (delay) and a low level of jitter (variations in delay) such as Voice over IP (VoIP) or Internet gaming, and those for which jitter alone is a problem such as Internet radio or streaming video.

This chapter contains information about configuring QoS and editing classifiers.

10.1.1 What You Can Do in this Chapter

- The **General** screen lets you enable or disable QoS and set the upstream bandwidth ([Section 10.3 on page 150](#)).
- The **Queue Setup** screen lets you configure QoS queue assignment ([Section 10.4 on page 151](#)).
- The **Class Setup** screen lets you add, edit or delete QoS classifiers ([Section 10.5 on page 153](#)).
- The **Policer Setup** screen lets you add, edit or delete QoS policers ([Section 10.5 on page 153](#)).

10.2 What You Need to Know

The following terms and concepts may help as you read through this chapter.

QoS versus Cos

QoS is used to prioritize source-to-destination traffic flows. All packets in the same flow are given the same priority. CoS (class of service) is a way of managing traffic in a network by grouping

similar types of traffic together and treating each type as a class. You can use CoS to give different priorities to different packet types.

CoS technologies include IEEE 802.1p layer 2 tagging and DiffServ (Differentiated Services or DS). IEEE 802.1p tagging makes use of three bits in the packet header, while DiffServ is a new protocol and defines a new DS field, which replaces the eight-bit ToS (Type of Service) field in the IP header.

Tagging and Marking

In a QoS class, you can configure whether to add or change the DSCP (DiffServ Code Point) value, IEEE 802.1p priority level and VLAN ID number in a matched packet. When the packet passes through a compatible network, the networking device, such as a backbone switch, can provide specific treatment or service based on the tag or marker.

Traffic Shaping

Bursty traffic may cause network congestion. Traffic shaping regulates packets to be transmitted with a pre-configured data transmission rate using buffers (or queues). Your Device uses the Token Bucket algorithm to allow a certain amount of large bursts while keeping a limit at the average rate.

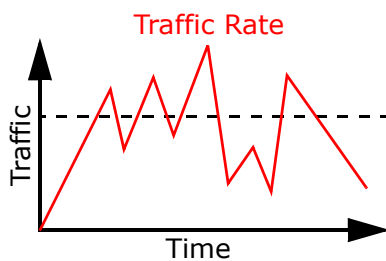

(Before Traffic Shaping)

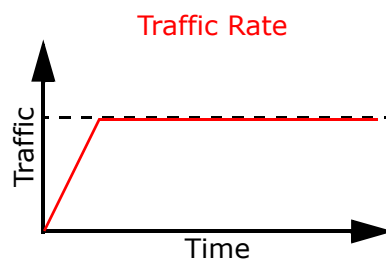

(After Traffic Shaping)

Traffic Policing

Traffic policing is the limiting of the input or output transmission rate of a class of traffic on the basis of user-defined criteria. Traffic policing methods measure traffic flows against user-defined criteria and identify it as either conforming, exceeding or violating the criteria.

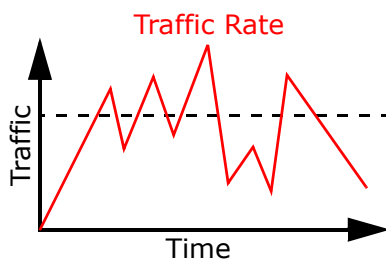

(Before Traffic Policing)

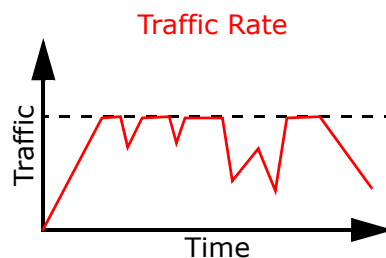

(After Traffic Policing)

The Device supports three incoming traffic metering algorithms: Token Bucket Filter (TBF), Single Rate Two Color Marker (srTCM), and Two Rate Two Color Marker (trTCM). You can specify actions

which are performed on the colored packets. See [Section 10.7 on page 160](#) for more information on each metering algorithm.

10.3 The Quality of Service General Screen

Click **Network Setting > QoS > General** to open the screen as shown next.

Use this screen to enable or disable QoS and set the upstream bandwidth. See [Section 10.1 on page 148](#) for more information.

Figure 69 Network Settings > QoS > General

QoS Enable Disable (settings are invalid when disabled)

WAN Managed Upstream Bandwidth : (kbps)

LAN Managed Downstream Bandwidth : (kbps)

Upstream traffic priority Assigned by:

Note:

You can assign the upstream bandwidth manually. If the field is empty, the CPE sets the value automatically.

If Enable QoS checkbox is selected, choose a default DSCP mark to automatically mark incoming traffic without reference to a particular classifier.

If the setting of WAN managed upstream bandwidth is greater than current WAN interface linkup rate, then the WAN managed upstream bandwidth will become current WAN interface linkup rate.

The following table describes the labels in this screen.

Table 45 Network Setting > QoS > General

LABEL	DESCRIPTION
QoS	Select the Enable check box to turn on QoS to improve your network performance.
WAN Managed Upstream Bandwidth	<p>Enter the amount of upstream bandwidth for the WAN interfaces that you want to allocate using QoS.</p> <p>The recommendation is to set this speed to match the interfaces' actual transmission speed. For example, set the WAN interfaces' speed to 100000 kbps if your Internet connection has an upstream transmission speed of 100 Mbps.</p> <p>You can set this number higher than the interfaces' actual transmission speed. The Device uses up to 95% of the DSL port's actual upstream transmission speed even if you set this number higher than the DSL port's actual transmission speed.</p> <p>You can also set this number lower than the interfaces' actual transmission speed. This will cause the Device to not use some of the interfaces' available bandwidth.</p> <p>If you leave this field blank, the Device automatically sets this number to be 95% of the WAN interfaces' actual upstream transmission speed.</p>

Table 45 Network Setting > QoS > General (continued) (continued)

LABEL	DESCRIPTION
LAN Managed Downstream Bandwidth	<p>Enter the amount of downstream bandwidth for the LAN interfaces (including WLAN) that you want to allocate using QoS.</p> <p>The recommendation is to set this speed to match the WAN interfaces' actual transmission speed. For example, set the LAN managed downstream bandwidth to 100000 kbps if you use a 100 Mbps wired Ethernet WAN connection.</p> <p>You can also set this number lower than the WAN interfaces' actual transmission speed. This will cause the Device to not use some of the interfaces' available bandwidth.</p> <p>If you leave this field blank, the Device automatically sets this to the LAN interfaces' maximum supported connection speed.</p>
Upstream traffic priority Assigned by	<p>Select how the Device assigns priorities to various upstream traffic flows.</p> <ul style="list-style-type: none"> • None: Disables auto priority mapping and has the Device put packets into the queues according to your classification rules. Traffic which does not match any of the classification rules is mapped into the default queue with the lowest priority. • Ethernet Priority: Automatically assign priority based on the IEEE 802.1p priority level. • IP Precedence: Automatically assign priority based on the first three bits of the TOS field in the IP header. • Packet Length: Automatically assign priority based on the packet size. Smaller packets get higher priority since control, signaling, VoIP, internet gaming, or other real-time packets are usually small while larger packets are usually best effort data packets like file transfers.
Apply	Click Apply to save your changes.
Cancel	Click Cancel to restore your previously saved settings.

10.4 The Queue Setup Screen

Click **Network Setting > QoS > Queue Setup** to open the screen as shown next.

Use this screen to configure QoS queue assignment.

Figure 70 Network Setting > QoS > Queue Setup

Queue Setup decides the priority on WAN/LAN interfaces. Use this page to configure QoS queue assignment.

Add new Queue

#	Status	Name	Interface	Priority	Weight	Buffer Management	Rate Limit (kbps)	Modify
1		DefaultQueue	WAN	8	1	DT	0	
2		VoiceQueue	WAN	1	1	DT	0	
3		Priority3	WAN	3	1	DT	0	
4		Priority4	WAN	4	1	DT	0	
5		Priority5	WAN	5	1	DT	0	

Note:
Maximum of 8 configurable entries for WAN port, and maximum of 3 configurable entries for LAN port.
If queue is deleted, then related classifiers will be removed too.
Priority level '1' is the highest priority for QoS.
Rate Limit '0' is max bandwidth.

The following table describes the labels in this screen.

Table 46 Network Setting > QoS > Queue Setup

LABEL	DESCRIPTION
Add new Queue	Click this button to create a new queue entry.
#	This is the index number of the entry.
Status	This field displays whether the queue is active or not. A yellow bulb signifies that this queue is active. A gray bulb signifies that this queue is not active.
Name	This shows the descriptive name of this queue.
Interface	This shows the name of the Device's interface through which traffic in this queue passes.
Priority	This shows the priority of this queue.
Weight	This shows the weight of this queue.
Buffer Management	This shows the queue management algorithm used for this queue. Queue management algorithms determine how the Device should handle packets when it receives too many (network congestion).
Rate Limit	This shows the maximum transmission rate allowed for traffic on this queue.
Modify	Click the Edit icon to edit the queue. Click the Delete icon to delete an existing queue. Note that subsequent rules move up by one when you take this action.

10.4.1 Adding a QoS Queue

Click **Add new Queue** or the edit icon in the **Queue Setup** screen to configure a queue.

Figure 71 Queue Setup: Add

The following table describes the labels in this screen.

Table 47 Queue Setup: Add

LABEL	DESCRIPTION
Active	Select to enable or disable this queue.
Name	Enter the descriptive name of this queue.
Interface	Select the interface to which this queue is applied. This field is read-only if you are editing the queue.

Table 47 Queue Setup: Add (continued)

LABEL	DESCRIPTION
Priority	Select the priority level (from 1 to 7) of this queue. The smaller the number, the higher the priority level. Traffic assigned to higher priority queues gets through faster while traffic in lower priority queues is dropped if the network is congested.
Weight	Select the weight (from 1 to 8) of this queue. If two queues have the same priority level, the Device divides the bandwidth across the queues according to their weights. Queues with larger weights get more bandwidth than queues with smaller weights.
Buffer Management	This field displays Drop Tail (DT) . Drop Tail (DT) is a simple queue management algorithm that allows the Device buffer to accept as many packets as it can until it is full. Once the buffer is full, new packets that arrive are dropped until there is space in the buffer again (packets are transmitted out of it).
Rate Limit	Specify the maximum transmission rate (in Kbps) allowed for traffic on this queue.
OK	Click OK to save your changes.
Cancel	Click Cancel to exit this screen without saving.

10.5 The Class Setup Screen

Use this screen to add, edit or delete QoS classifiers. A classifier groups traffic into data flows according to specific criteria such as the source address, destination address, source port number, destination port number or incoming interface. For example, you can configure a classifier to select traffic from the same protocol port (such as Telnet) to form a flow.

You can give different priorities to traffic that the Device forwards out through the WAN interface. Give high priority to voice and video to make them run more smoothly. Similarly, give low priority to many large file downloads so that they do not reduce the quality of other applications.

Click **Network Setting > QoS > Class Setup** to open the following screen.

Figure 72 Network Setting > QoS > Class Setup

General Queue Setup Class Setup Class Setup Policer Setup								
A classifier groups traffic into data flows according to specific criteria. Class Setup can add, edit, or delete QoS classifiers.								
Add new Classifier								
#	Status	Class Name	Classification Criteria	DSCP Mark	802.1P Mark	VLAN ID Tag	To Queue	Modify
1		Local_Service	From Intf: Local	Unchange	Unchange	Unchange	Priority5	
2		SSH	From Intf: LAN Ether Type: IP Dst Port: 22 Protocol: TCP	Unchange	Unchange	Unchange	Priority4	
3		DNS	From Intf: LAN Ether Type: IP Dst Port: 53 Protocol: UDP	Unchange	Unchange	Unchange	Priority4	
4		ICMP	From Intf: Local Ether Type: IP Protocol: ICMP	Unchange	Unchange	Unchange	Priority3	
5		IKE	From Intf: LAN Ether Type: IP Dst Port: 500 Protocol: UDP	Unchange	Unchange	Unchange	Priority4	
6		RTSP	From Intf: LAN Ether Type: IP Dst Port: 554 Protocol: TCP	Unchange	Unchange	Unchange	Priority3	
7		AH	From Intf: LAN Ether Type: IP Protocol: 51	Unchange	Unchange	Unchange	Priority3	
8		ESP	From Intf: LAN Ether Type: IP Protocol: 60	Unchange	Unchange	Unchange	Priority3	
9		HTTP	From Intf: LAN Ether Type: IP Dst Port: 80 Protocol: TCP	Unchange	Unchange	Unchange	Priority3	
10		HTTP.Proxy	From Intf: LAN Ether Type: IP Dst Port: 8080 Protocol: TCP	Unchange	Unchange	Unchange	Priority3	
11		HTTPS	From Intf: LAN Ether Type: IP Dst Port: 443 Protocol: TCP	Unchange	Unchange	Unchange	Priority3	
12		Telnet	From Intf: LAN Ether Type: IP Dst Port: 23 Protocol: TCP	Unchange	Unchange	Unchange	Priority3	
13		IGMP	From Intf: Local Ether Type: IP Protocol: IGMP	Unchange	Unchange	Unchange	Priority3	

The following table describes the labels in this screen.

Table 48 Network Setting > QoS > Class Setup

LABEL	DESCRIPTION
Add new Classifier	Click this to create a new classifier.
#	This is the index number of the entry.
Status	This field displays whether the classifier is active or not. A yellow bulb signifies that this classifier is active. A gray bulb signifies that this classifier is not active.
Class Name	This is the name of the classifier.
Classification Criteria	This shows criteria specified in this classifier, for example the interface from which traffic of this class should come and the source MAC address of traffic that matches this classifier.
DSCP Mark	This is the DSCP number added to traffic of this classifier.
802.1P Mark	This is the IEEE 802.1p priority level assigned to traffic of this classifier.
VLAN ID Tag	This is the VLAN ID number assigned to traffic of this classifier.
To Queue	This is the name of the queue in which traffic of this classifier is put.
Modify	Click the Edit icon to edit the classifier. Click the Delete icon to delete an existing classifier. Note that subsequent rules move up by one when you take this action.

10.5.1 Add/Edit QoS Class

Click **Add new Classifier** in the **Class Setup** screen or the **Edit** icon next to a classifier to open the following screen.

Figure 73 Class Setup: Add/Edit

QoS Classifier Configuration

Please follow the guidance through step 1~5 to configure a QoS rule

Step1: Class configuration

Active

Class Name :

Classification Order :

Step2: Criteria configuration

Use the fields below to specify the characteristics of a data flow that needs to be managed by this QoS rule

▪ **Basic**

From Interface :

Ether Type :

▪ **Source**

Address Subnet Netmask/Prefix Length Exclude

Port Range ~ Exclude

MAC (xxxxxxxxxxxx) MAC Mask Exclude

▪ **Destination**

Address Subnet Netmask/Prefix Length Exclude

Port Range ~ Exclude

MAC (xxxxxxxxxxxx) MAC Mask Exclude

▪ **Others**

Service Exclude

IP Protocol Exclude

DHCP Exclude

Packet Length ~ Exclude

DSCP (0~63) Exclude

802.1P Exclude

VLAN ID (0~4094) Exclude

TCP ACK Exclude

Step3: Packet modification

The content of the packet can be modified by applying the following settings:

DSCP Mark : (0~63)

802.1P Mark :

VLAN ID : (0~4094)

Step4 Policy Forwarding

This module can route or bridge packets to certain interface according to the class settings:

Forward To Interface :

Step5: Outgoing queue selection

Outgoing queue decides the priority of the traffic and how traffic should be shaped in the WAN interface. Choose 'None' if you do not want to apply outgoing queue

To Queue Index :

The following table describes the labels in this screen.

Table 49 Class Setup: Add/Edit

LABEL	DESCRIPTION
Active	Select this to enable this classifier.
Class Name	Enter a descriptive name of up to 15 printable English keyboard characters, not including spaces.

Table 49 Class Setup: Add/Edit (continued)

LABEL	DESCRIPTION
Classification Order	Select an existing number for where you want to put this classifier to move the classifier to the number you selected after clicking Apply . Select Last to put this rule in the back of the classifier list.
From Interface	If you want to classify the traffic by an ingress interface, select an interface from the From Interface drop-down list box.
Ether Type	Select a predefined application to configure a class for the matched traffic. If you select IP , you also need to configure source or destination MAC address, IP address, DHCP options, DSCP value or the protocol type. If you select 802.1Q , you can configure an 802.1p priority level.
Source	
Address	Select the check box and enter the source IP address in dotted decimal notation. A blank source IP address means any source IP address.
Subnet Netmask	Enter the source subnet mask.
Port Range	If you select TCP or UDP in the IP Protocol field, select the check box and enter the port number(s) of the source.
MAC	Select the check box and enter the source MAC address of the packet.
MAC Mask	Type the mask for the specified MAC address to determine which bits a packet's MAC address should match. Enter "f" for each bit of the specified source MAC address that the traffic's MAC address should match. Enter "0" for the bit(s) of the matched traffic's MAC address, which can be of any hexadecimal character(s). For example, if you set the MAC address to 00:13:49:00:00:00 and the mask to ff:ff:ff:00:00:00, a packet with a MAC address of 00:13:49:12:34:56 matches this criteria.
Exclude	Select this option to exclude the packets that match the specified criteria from this classifier.
Destination	
Address	Select the check box and enter the source IP address in dotted decimal notation. A blank source IP address means any source IP address.
Subnet Netmask	Enter the source subnet mask.
Port Range	If you select TCP or UDP in the IP Protocol field, select the check box and enter the port number(s) of the source.
MAC	Select the check box and enter the source MAC address of the packet.
MAC Mask	Type the mask for the specified MAC address to determine which bits a packet's MAC address should match. Enter "f" for each bit of the specified source MAC address that the traffic's MAC address should match. Enter "0" for the bit(s) of the matched traffic's MAC address, which can be of any hexadecimal character(s). For example, if you set the MAC address to 00:13:49:00:00:00 and the mask to ff:ff:ff:00:00:00, a packet with a MAC address of 00:13:49:12:34:56 matches this criteria.
Exclude	Select this option to exclude the packets that match the specified criteria from this classifier.
Others	
Service	This field is available only when you select IP in the Ether Type field. This field simplifies classifier configuration by allowing you to select a predefined application. When you select a predefined application, you do not configure the rest of the filter fields.

Table 49 Class Setup: Add/Edit (continued)

LABEL	DESCRIPTION
IP Protocol	<p>This field is available only when you select IP in the Ether Type field.</p> <p>Select this option and select the protocol (service type) from TCP, UDP, ICMP or IGMP. If you select User defined, enter the protocol (service type) number.</p>
DHCP	<p>This field is available only when you select IP in the Ether Type field.</p> <p>Select this option and select a DHCP option.</p> <p>If you select Vendor Class ID (DHCP Option 60), enter the Vendor Class Identifier (Option 60) of the matched traffic, such as the type of the hardware or firmware.</p> <p>If you select User Class ID (DHCP Option 77), enter a string that identifies the user's category or application type in the matched DHCP packets.</p>
Packet Length	<p>This field is available only when you select IP in the Ether Type field.</p> <p>Select this option and enter the minimum and maximum packet length (from 46 to 1500) in the fields provided.</p>
DSCP	<p>This field is available only when you select IP in the Ether Type field.</p> <p>Select this option and specify a DSCP (DiffServ Code Point) number between 0 and 63 in the field provided.</p>
802.1P	<p>This field is available only when you select 802.1Q in the Ether Type field.</p> <p>Select this option and select a priority level (between 0 and 7) from the drop-down list box. "0" is the lowest priority level and "7" is the highest.</p>
VLAN ID	<p>This field is available only when you select 802.1Q in the Ether Type field.</p> <p>Select this option and specify a VLAN ID number.</p>
TCP ACK	<p>This field is available only when you select IP in the Ether Type field.</p> <p>If you select this option, the matched TCP packets must contain the ACK (Acknowledge) flag.</p>
Exclude	<p>Select this option to exclude the packets that match the specified criteria from this classifier.</p>
DSCP Mark	<p>This field is available only when you select IP in the Ether Type field.</p> <p>If you select Mark, enter a DSCP value with which the Device replaces the DSCP field in the packets.</p> <p>If you select Unchange, the Device keep the DSCP field in the packets.</p>
802.1P Mark	<p>Select a priority level with which the Device replaces the IEEE 802.1p priority field in the packets.</p> <p>If you select Unchange, the Device keep the 802.1p priority field in the packets.</p>
VLAN ID	<p>If you select Remark, enter a VLAN ID number with which the Device replaces the VLAN ID of the frames.</p> <p>If you select Remove, the Device deletes the VLAN ID of the frames before forwarding them out.</p> <p>If you select Add, the Device treat all matched traffic untagged and add a second VLAN ID.</p> <p>If you select Unchange, the Device keep the VLAN ID in the packets.</p>
Forward to Interface	<p>Select a WAN interface through which traffic of this class will be forwarded out. If you select Unchange, the Device forward traffic of this class according to the default routing table.</p>
To Queue Index	<p>Select a queue that applies to this class.</p> <p>You should have configured a queue in the Queue Setup screen already.</p>

Table 49 Class Setup: Add/Edit (continued)

LABEL	DESCRIPTION
Apply	Click Apply to save your changes.
Cancel	Click Cancel to exit this screen without saving.

10.6 The QoS Policer Setup Screen

Use this screen to configure QoS policers that allow you to limit the transmission rate of incoming traffic. Click **Network Setting > QoS > Policer Setup**. The screen appears as shown.

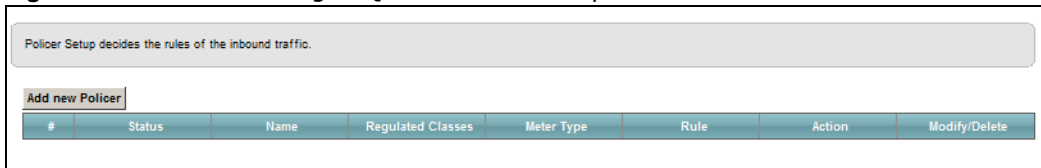
Figure 74 Network Setting > QoS > Policer Setup

The following table describes the labels in this screen.

Table 50 Network Setting > QoS > Policer Setup

LABEL	DESCRIPTION
Add new Policer	Click this to create a new entry.
#	This is the index number of the entry.
Status	This field displays whether the policer is active or not. A yellow bulb signifies that this policer is active. A gray bulb signifies that this policer is not active.
Name	This field displays the descriptive name of this policer.
Regulated Classes	This field displays the name of a QoS classifier
Meter Type	This field displays the type of QoS metering algorithm used in this policer.
Rule	These are the rates and burst sizes against which the policer checks the traffic of the member QoS classes.
Action	This shows the how the policer has the Device treat different types of traffic belonging to the policer's member QoS classes.
Modify	Click the Edit icon to edit the policer. Click the Delete icon to delete an existing policer. Note that subsequent rules move up by one when you take this action.

10.6.1 Add/Edit a QoS Policer

Click **Add new Policer** in the **Policer Setup** screen or the **Edit** icon next to a policer to show the following screen.

Figure 75 Policer Setup: Add/Edit

The following table describes the labels in this screen.

Table 51 Policer Setup: Add/Edit

LABEL	DESCRIPTION
Active	Select the check box to activate this policer.
Name	Enter the descriptive name of this policer.
Meter Type	This shows the traffic metering algorithm used in this policer. The Simple Token Bucket algorithm uses tokens in a bucket to control when traffic can be transmitted. Each token represents one byte. The algorithm allows bursts of up to b bytes which is also the bucket size. The Single Rate Three Color Marker (srTCM) is based on the token bucket filter and identifies packets by comparing them to the Committed Information Rate (CIR), the Committed Burst Size (CBS) and the Excess Burst Size (EBS). The Two Rate Three Color Marker (trTCM) is based on the token bucket filter and identifies packets by comparing them to the Committed Information Rate (CIR) and the Peak Information Rate (PIR).
Committed Rate	Specify the committed rate. When the incoming traffic rate of the member QoS classes is less than the committed rate, the device applies the conforming action to the traffic.
Committed Burst Size	Specify the committed burst size for packet bursts. This must be equal to or less than the peak burst size (two rate three color) or excess burst size (single rate three color) if it is also configured. This is the maximum size of the (first) token bucket in a traffic metering algorithm.

Table 51 Policer Setup: Add/Edit

LABEL	DESCRIPTION
Conforming Action	Specify what the Device does for packets within the committed rate and burst size (green-marked packets). <ul style="list-style-type: none"> • Pass: Send the packets without modification. • DSCP Mark: Change the DSCP mark value of the packets. Enter the DSCP mark value to use.
Non-Conforming Action	Specify what the Device does for packets that exceed the excess burst size or peak rate and burst size (red-marked packets). <ul style="list-style-type: none"> • Drop: Discard the packets. • DSCP Mark: Change the DSCP mark value of the packets. Enter the DSCP mark value to use. The packets may be dropped if there is congestion on the network.
Available Class	Select a QoS classifier to apply this QoS policer to traffic that matches the QoS classifier.
Selected Class	Highlight a QoS classifier in the Available Class box and use the > button to move it to the Selected Class box. To remove a QoS classifier from the Selected Class box, select it and use the < button.
Apply	Click Apply to save your changes.
Cancel	Click Cancel to exit this screen without saving.

10.7 Technical Reference

The following section contains additional technical information about the Device features described in this chapter.

IEEE 802.1Q Tag

The IEEE 802.1Q standard defines an explicit VLAN tag in the MAC header to identify the VLAN membership of a frame across bridges. A VLAN tag includes the 12-bit VLAN ID and 3-bit user priority. The VLAN ID associates a frame with a specific VLAN and provides the information that devices need to process the frame across the network.

IEEE 802.1p specifies the user priority field and defines up to eight separate traffic types. The following table describes the traffic types defined in the IEEE 802.1d standard (which incorporates the 802.1p).

Table 52 IEEE 802.1p Priority Level and Traffic Type

PRIORITY LEVEL	TRAFFIC TYPE
Level 7	Typically used for network control traffic such as router configuration messages.
Level 6	Typically used for voice traffic that is especially sensitive to jitter (jitter is the variations in delay).
Level 5	Typically used for video that consumes high bandwidth and is sensitive to jitter.
Level 4	Typically used for controlled load, latency-sensitive traffic such as SNA (Systems Network Architecture) transactions.
Level 3	Typically used for "excellent effort" or better than best effort and would include important business traffic that can tolerate some delay.
Level 2	This is for "spare bandwidth".

Table 52 IEEE 802.1p Priority Level and Traffic Type

PRIORITY LEVEL	TRAFFIC TYPE
Level 1	This is typically used for non-critical "background" traffic such as bulk transfers that are allowed but that should not affect other applications and users.
Level 0	Typically used for best-effort traffic.

DiffServ

QoS is used to prioritize source-to-destination traffic flows. All packets in the flow are given the same priority. You can use CoS (class of service) to give different priorities to different packet types.

DiffServ (Differentiated Services) is a class of service (CoS) model that marks packets so that they receive specific per-hop treatment at DiffServ-compliant network devices along the route based on the application types and traffic flow. Packets are marked with DiffServ Code Points (DSCPs) indicating the level of service desired. This allows the intermediary DiffServ-compliant network devices to handle the packets differently depending on the code points without the need to negotiate paths or remember state information for every flow. In addition, applications do not have to request a particular service or give advanced notice of where the traffic is going.

DSCP and Per-Hop Behavior

DiffServ defines a new Differentiated Services (DS) field to replace the Type of Service (TOS) field in the IP header. The DS field contains a 2-bit unused field and a 6-bit DSCP field which can define up to 64 service levels. The following figure illustrates the DS field.

DSCP is backward compatible with the three precedence bits in the ToS octet so that non-DiffServ compliant, ToS-enabled network device will not conflict with the DSCP mapping.

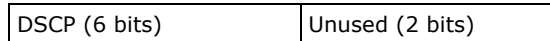

The DSCP value determines the forwarding behavior, the PHB (Per-Hop Behavior), that each packet gets across the DiffServ network. Based on the marking rule, different kinds of traffic can be marked for different kinds of forwarding. Resources can then be allocated according to the DSCP values and the configured policies.

IP Precedence

Similar to IEEE 802.1p prioritization at layer-2, you can use IP precedence to prioritize packets in a layer-3 network. IP precedence uses three bits of the eight-bit ToS (Type of Service) field in the IP header. There are eight classes of services (ranging from zero to seven) in IP precedence. Zero is the lowest priority level and seven is the highest.

Automatic Priority Queue Assignment

If you enable QoS on the Device, the Device can automatically base on the IEEE 802.1p priority level, IP precedence and/or packet length to assign priority to traffic which does not match a class.

The following table shows you the internal layer-2 and layer-3 QoS mapping on the Device. On the Device, traffic assigned to higher priority queues gets through faster while traffic in lower index queues is dropped if the network is congested.

Table 53 Internal Layer2 and Layer3 QoS Mapping

PRIORITY QUEUE	LAYER 2	LAYER 3		
	IEEE 802.1P USER PRIORITY (ETHERNET PRIORITY)	TOS (IP PRECEDENCE)	DSCP	IP PACKET LENGTH (BYTE)
0	1	0	000000	
1	2			
2	0	0	000000	>1100
3	3	1	001110 001100 001010 001000	250~1100
4	4	2	010110 010100 010010 010000	
5	5	3	011110 011100 011010 011000	<250
6	6	4	100110 100100 100010 100000	
		5	101110 101000	
7	7	6	110000	
		7	111000	

Token Bucket

The token bucket algorithm uses tokens in a bucket to control when traffic can be transmitted. The bucket stores tokens, each of which represents one byte. The algorithm allows bursts of up to b bytes which is also the bucket size, so the bucket can hold up to b tokens. Tokens are generated and added into the bucket at a constant rate. The following shows how tokens work with packets:

- A packet can be transmitted if the number of tokens in the bucket is equal to or greater than the size of the packet (in bytes).
- After a packet is transmitted, a number of tokens corresponding to the packet size is removed from the bucket.

- If there are no tokens in the bucket, the Device stops transmitting until enough tokens are generated.
- If not enough tokens are available, the Device treats the packet in either one of the following ways:

In traffic shaping:

- Holds it in the queue until enough tokens are available in the bucket.

In traffic policing:

- Drops it.
- Transmits it but adds a DSCP mark. The Device may drop these marked packets if the network is overloaded.

Configure the bucket size to be equal to or less than the amount of the bandwidth that the interface can support. It does not help if you set it to a bucket size over the interface's capability. The smaller the bucket size, the lower the data transmission rate and that may cause outgoing packets to be dropped. A larger transmission rate requires a big bucket size. For example, use a bucket size of 10 kbytes to get the transmission rate up to 10 Mbps.

Single Rate Three Color Marker

The Single Rate Three Color Marker (srTCM, defined in RFC 2697) is a type of traffic policing that identifies packets by comparing them to one user-defined rate, the Committed Information Rate (CIR), and two burst sizes: the Committed Burst Size (CBS) and Excess Burst Size (EBS).

The srTCM evaluates incoming packets and marks them with one of three colors which refer to packet loss priority levels. High packet loss priority level is referred to as red, medium is referred to as yellow and low is referred to as green.

The srTCM is based on the token bucket filter and has two token buckets (CBS and EBS). Tokens are generated and added into the bucket at a constant rate, called Committed Information Rate (CIR). When the first bucket (CBS) is full, new tokens overflow into the second bucket (EBS).

All packets are evaluated against the CBS. If a packet does not exceed the CBS it is marked green. Otherwise it is evaluated against the EBS. If it is below the EBS then it is marked yellow. If it exceeds the EBS then it is marked red.

The following shows how tokens work with incoming packets in srTCM:

- A packet arrives. The packet is marked green and can be transmitted if the number of tokens in the CBS bucket is equal to or greater than the size of the packet (in bytes).
- After a packet is transmitted, a number of tokens corresponding to the packet size is removed from the CBS bucket.
- If there are not enough tokens in the CBS bucket, the Device checks the EBS bucket. The packet is marked yellow if there are sufficient tokens in the EBS bucket. Otherwise, the packet is marked red. No tokens are removed if the packet is dropped.

Two Rate Three Color Marker

The Two Rate Three Color Marker (trTCM, defined in RFC 2698) is a type of traffic policing that identifies packets by comparing them to two user-defined rates: the Committed Information Rate (CIR) and the Peak Information Rate (PIR). The CIR specifies the average rate at which packets are admitted to the network. The PIR is greater than or equal to the CIR. CIR and PIR values are based

on the guaranteed and maximum bandwidth respectively as negotiated between a service provider and client.

The trTCM evaluates incoming packets and marks them with one of three colors which refer to packet loss priority levels. High packet loss priority level is referred to as red, medium is referred to as yellow and low is referred to as green.

The trTCM is based on the token bucket filter and has two token buckets (Committed Burst Size (CBS) and Peak Burst Size (PBS)). Tokens are generated and added into the two buckets at the CIR and PIR respectively.

All packets are evaluated against the PIR. If a packet exceeds the PIR it is marked red. Otherwise it is evaluated against the CIR. If it exceeds the CIR then it is marked yellow. Finally, if it is below the CIR then it is marked green.

The following shows how tokens work with incoming packets in trTCM:

- A packet arrives. If the number of tokens in the PBS bucket is less than the size of the packet (in bytes), the packet is marked red and may be dropped regardless of the CBS bucket. No tokens are removed if the packet is dropped.
- If the PBS bucket has enough tokens, the Device checks the CBS bucket. The packet is marked green and can be transmitted if the number of tokens in the CBS bucket is equal to or greater than the size of the packet (in bytes). Otherwise, the packet is marked yellow.

Network Address Translation (NAT)

11.1 Overview

This chapter discusses how to configure NAT on the Device. NAT (Network Address Translation - NAT, RFC 1631) is the translation of the IP address of a host in a packet, for example, the source address of an outgoing packet, used within one network to a different IP address known within another network.

11.1.1 What You Can Do in this Chapter

- Use the **Port Forwarding** screen to configure forward incoming service requests to the server(s) on your local network ([Section 11.2 on page 166](#)).
- Use the **Applications** screen to forward incoming service requests to the server(s) on your local network ([Section 11.3 on page 169](#)).
- Use the **Port Triggering** screen to add and configure the Device's trigger port settings ([Section 11.4 on page 171](#)).
- Use the **DMZ** screen to configure a default server ([Section 11.5 on page 173](#)).
- Use the **ALG** screen to enable and disable the NAT and SIP (VoIP) ALG in the Device ([Section 11.6 on page 174](#)).
- Use the **Address Mapping** screen to configure the Device's address mapping settings ([Section 11.7 on page 175](#)).
- Use the **Sessions** screen to configure the Device's maximum number of NAT sessions ([Section 11.7 on page 175](#)).

11.1.2 What You Need To Know

Inside/Outside

Inside/outside denotes where a host is located relative to the Device, for example, the computers of your subscribers are the inside hosts, while the web servers on the Internet are the outside hosts.

Global/Local

Global/local denotes the IP address of a host in a packet as the packet traverses a router, for example, the local address refers to the IP address of a host when the packet is in the local network, while the global address refers to the IP address of the host when the same packet is traveling in the WAN side.

NAT

In the simplest form, NAT changes the source IP address in a packet received from a subscriber (the inside local address) to another (the inside global address) before forwarding the packet to the WAN side. When the response comes back, NAT translates the destination address (the inside global address) back to the inside local address before forwarding it to the original inside host.

Port Forwarding

A port forwarding set is a list of inside (behind NAT on the LAN) servers, for example, web or FTP, that you can make visible to the outside world even though NAT makes your whole inside network appear as a single computer to the outside world.

Finding Out More

See [Section 11.9 on page 177](#) for advanced technical information on NAT.

11.2 The Port Forwarding Screen

Use the **Port Forwarding** screen to forward incoming service requests to the server(s) on your local network.

You may enter a single port number or a range of port numbers to be forwarded, and the local IP address of the desired server. The port number identifies a service; for example, web service is on port 80 and FTP on port 21. In some cases, such as for unknown services or where one server can support more than one service (for example both FTP and web service), it might be better to specify a range of port numbers. You can allocate a server IP address that corresponds to a port or a range of ports.

The most often used port numbers and services are shown in [Appendix D on page 314](#). Please refer to RFC 1700 for further information about port numbers.

Note: Many residential broadband ISP accounts do not allow you to run any server processes (such as a Web or FTP server) from your location. Your ISP may periodically check for servers and may suspend your account if it discovers any active services at your location. If you are unsure, refer to your ISP.

Configuring Servers Behind Port Forwarding (Example)

Let's say you want to assign ports 21-25 to one FTP, Telnet and SMTP server (**A** in the example), port 80 to another (**B** in the example) and assign a default server IP address of 192.168.1.35 to a third (**C** in the example). You assign the LAN IP addresses and the ISP assigns the WAN IP address. The NAT network appears as a single host on the Internet.

Figure 76 Multiple Servers Behind NAT Example

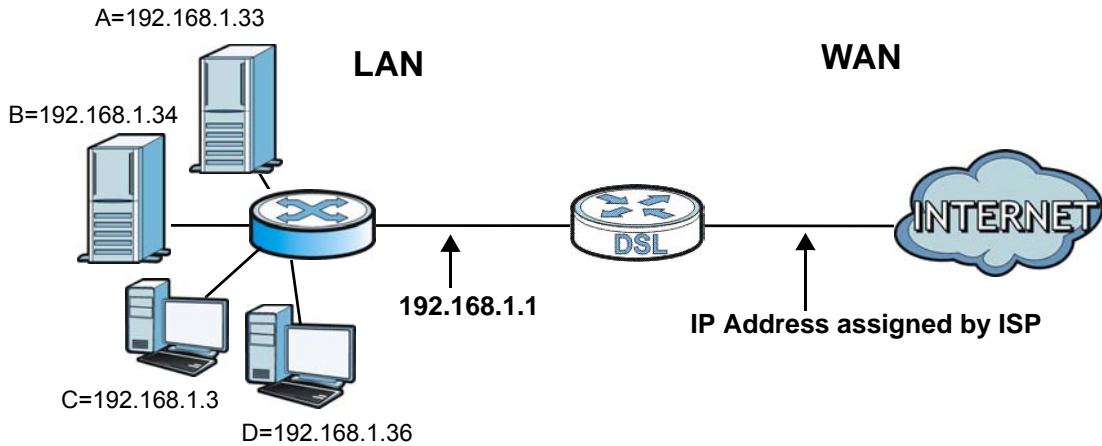

Click **Network Setting > NAT > Port Forwarding** to open the following screen.

See [Appendix D on page 314](#) for port numbers commonly used for particular services.

Figure 77 Network Setting > NAT > Port Forwarding

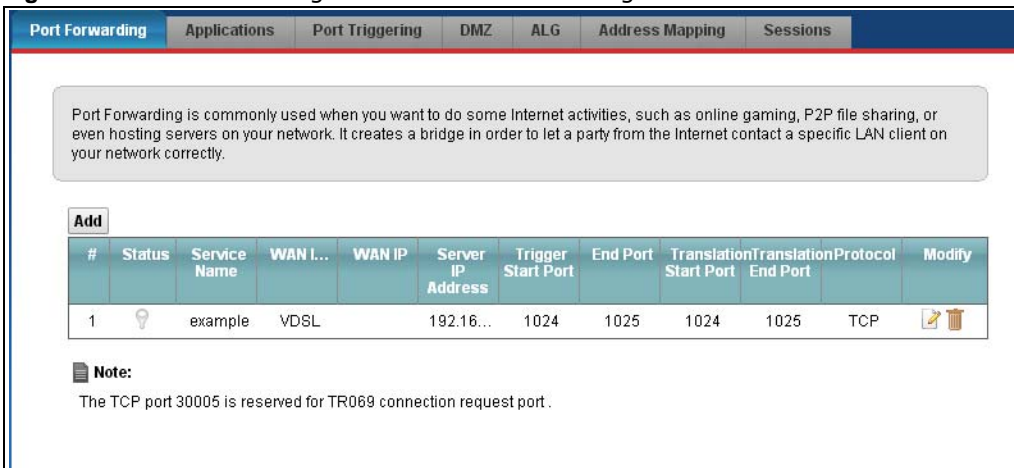

The following table describes the fields in this screen.

Table 54 Network Setting > NAT > Port Forwarding

LABEL	DESCRIPTION
Add new rule	Click this to add a new rule.
#	This is the index number of the entry.
Status	This field displays whether the NAT rule is active or not. A yellow bulb signifies that this rule is active. A gray bulb signifies that this rule is not active.
Service Name	This shows the service's name.
WAN Interface	This shows the WAN interface through which the service is forwarded.
WAN IP	This field displays the incoming packet's destination IP address.
Server IP Address	This is the server's IP address.
Start Port	This is the first external port number that identifies a service.

Table 54 Network Setting > NAT > Port Forwarding (continued)

LABEL	DESCRIPTION
End Port	This is the last external port number that identifies a service.
Translation Start Port	This is the first internal port number that identifies a service.
Translation End Port	This is the last internal port number that identifies a service.
Protocol	This shows the IP protocol supported by this virtual server, whether it is TCP , UDP , or TCP/UDP .
Modify	Click the Edit icon to edit this rule. Click the Delete icon to delete an existing rule.

11.2.1 Add/Edit Port Forwarding

Click **Add new rule** in the **Port Forwarding** screen or click the **Edit** icon next to an existing rule to open the following screen.

Figure 78 Port Forwarding: Add/Edit

Add new rule

Active

Service Name :

WAN Interface :

WAN IP :

Trigger Start Port :

End Port :

Translation Start Port :

Translation End Port :

Server IP Address :

Protocol :

Wake up this target by Wake On Lan(WOL)

MAC address of WOL device

Note:

1. If Start Port and End Port configured to the same port, the input text of Translation Start Port can be configurable, and when user configure this value to different port number, it means configure for Port Translation.(one to one mapping)
2. WAN IP is optional. If user wants to present Multi-to-Multi NAT, user can assign the desired device WAN IP.

OK Cancel

The following table describes the labels in this screen.

Table 55 Port Forwarding: Add/Edit

LABEL	DESCRIPTION
Active	Clear the checkbox to disable the rule. Select the check box to enable it.
Service Name	Enter a name to identify this rule using keyboard characters (A-Z, a-z, 1-2 and so on).
WAN Interface	Select the WAN interface through which the service is forwarded. You must have already configured a WAN connection with NAT enabled.

Table 55 Port Forwarding: Add/Edit (continued)

LABEL	DESCRIPTION
WAN IP	Enter the WAN IP address for which the incoming service is destined. If the packet's destination IP address doesn't match the one specified here, the port forwarding rule will not be applied.
Start Port	Enter the original destination port for the packets. To forward only one port, enter the port number again in the End Port field. To forward a series of ports, enter the start port number here and the end port number in the End Port field.
End Port	Enter the last port of the original destination port range. To forward only one port, enter the port number in the Start Port field above and then enter it again in this field. To forward a series of ports, enter the last port number in a series that begins with the port number in the Start Port field above.
Translation Start Port	This shows the port number to which you want the Device to translate the incoming port. For a range of ports, enter the first number of the range to which you want the incoming ports translated.
Translation End Port	This shows the last port of the translated port range.
Server IP Address	Enter the inside IP address of the virtual server here.
Protocol	Select the protocol supported by this virtual server. Choices are TCP , UDP , or TCP/UDP .
OK	Click OK to save your changes.
Cancel	Click Cancel to exit this screen without saving.

11.3 The Applications Screen

This screen provides a summary of all NAT applications and their configuration. In addition, this screen allows you to create new applications and/or remove existing ones.

To access this screen, click **Network Setting > NAT > Applications**. The following screen appears.

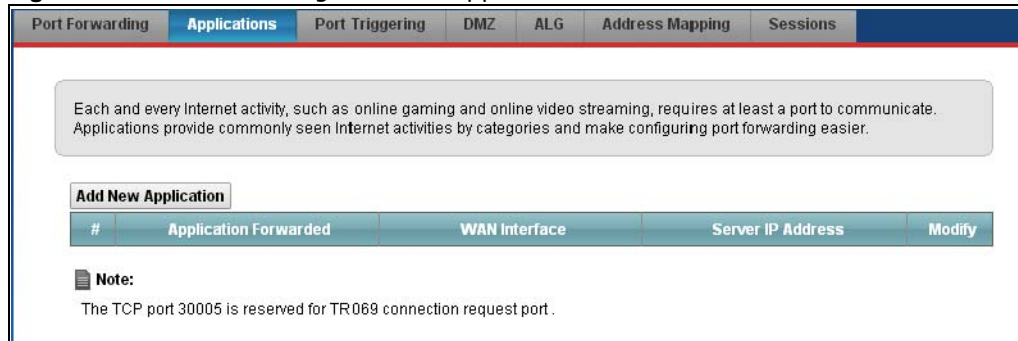
Figure 79 Network Setting > NAT > Applications

The following table describes the labels in this screen.

Table 56 Network Setting > NAT > Applications

LABEL	DESCRIPTION
Add new application	Click this to add a new NAT application rule.
Application Forwarded	This field shows the type of application that the service forwards.
WAN Interface	This field shows the WAN interface through which the service is forwarded.
Server IP Address	This field displays the destination IP address for the service.
Modify	Click the Delete icon to delete the rule.

11.3.1 Add New Application

This screen lets you create new NAT application rules. Click **Add new application** in the **Applications** screen to open the following screen.

Figure 80 Applications: Add

The following table describes the labels in this screen.

Table 57 Applications: Add

LABEL	DESCRIPTION
WAN Interface	Select the WAN interface that you want to apply this NAT rule to.
Server IP Address	Enter the inside IP address of the application here.
Application Category	Select the category of the application from the drop-down list box.
Application Forwarded	Select a service from the drop-down list box and the Device automatically configures the protocol, start, end, and map port number that define the service.
View Rule	Click this to display the configuration of the service that you have chosen in Application Forwarded .
OK	Click OK to save your changes.
Cancel	Click Cancel to exit this screen without saving.

11.4 The Port Triggering Screen

Some services use a dedicated range of ports on the client side and a dedicated range of ports on the server side. With regular port forwarding you set a forwarding port in NAT to forward a service (coming in from the server on the WAN) to the IP address of a computer on the client side (LAN). The problem is that port forwarding only forwards a service to a single LAN IP address. In order to use the same service on a different LAN computer, you have to manually replace the LAN computer's IP address in the forwarding port with another LAN computer's IP address.

Trigger port forwarding solves this problem by allowing computers on the LAN to dynamically take turns using the service. The Device records the IP address of a LAN computer that sends traffic to the WAN to request a service with a specific port number and protocol (a "trigger" port). When the Device's WAN port receives a response with a specific port number and protocol ("open" port), the Device forwards the traffic to the LAN IP address of the computer that sent the request. After that computer's connection for that service closes, another computer on the LAN can use the service in the same manner. This way you do not need to configure a new IP address each time you want a different LAN computer to use the application.

For example:

Figure 81 Trigger Port Forwarding Process: Example

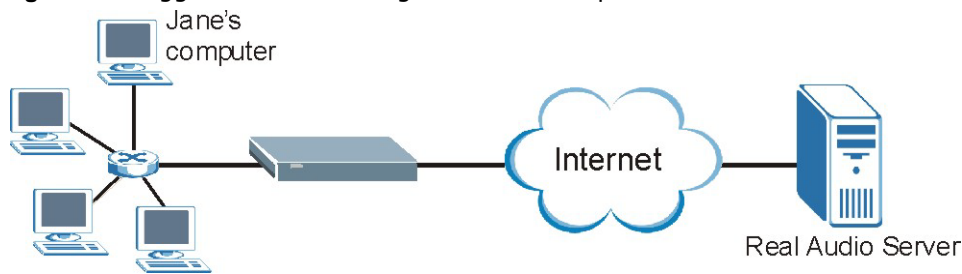

- 1 Jane requests a file from the Real Audio server (port 7070).
- 2 Port 7070 is a "trigger" port and causes the Device to record Jane's computer IP address. The Device associates Jane's computer IP address with the "open" port range of 6970-7170.
- 3 The Real Audio server responds using a port number ranging between 6970-7170.
- 4 The Device forwards the traffic to Jane's computer IP address.
- 5 Only Jane can connect to the Real Audio server until the connection is closed or times out. The Device times out in three minutes with UDP (User Datagram Protocol) or two hours with TCP/IP (Transfer Control Protocol/Internet Protocol).

Click **Network Setting > NAT > Port Triggering** to open the following screen. Use this screen to view your Device's trigger port settings.

Figure 82 Network Setting > NAT > Port Triggering

Port Triggering is a way to automate port forwarding with a little better security. It dynamically forwards connection or data to whatever LAN client made a certain outgoing connection. Example: You define port 25 as Trigger Port and port 113 as Open Port. If any of the LAN devices on your network creates an outgoing connection via port 25, all incoming connections via port 113 will temporarily go to that client.

Add

#	Status	Service Name	WAN Interface	Trigger Start Port	Trigger End Port	Trigger Proto.	Open Start Port	Open End Port	Open Proto.	Modify
---	--------	--------------	---------------	--------------------	------------------	----------------	-----------------	---------------	-------------	--------

Note:

1. The sum of trigger ports in all rules must be less than 1000 and every open port range must be less than 1000. When the protocol is TCP/UDP, the ports are counted twice.
2. The TCP port 30005 is reserved for TR069 connection request port.

The following table describes the labels in this screen.

Table 58 Network Setting > NAT > Port Triggering

LABEL	DESCRIPTION
Add new rule	Click this to create a new rule.
#	This is the index number of the entry.
Status	This field displays whether the port triggering rule is active or not. A yellow bulb signifies that this rule is active. A gray bulb signifies that this rule is not active.
Service Name	This field displays the name of the service used by this rule.
WAN Interface	This field shows the WAN interface through which the service is forwarded.
Trigger Start Port	The trigger port is a port (or a range of ports) that causes (or triggers) the Device to record the IP address of the LAN computer that sent the traffic to a server on the WAN. This is the first port number that identifies a service.
Trigger End Port	This is the last port number that identifies a service.
Trigger Proto.	This is the trigger transport layer protocol.
Open Start Port	The open port is a port (or a range of ports) that a server on the WAN uses when it sends out a particular service. The Device forwards the traffic with this port (or range of ports) to the client computer on the LAN that requested the service. This is the first port number that identifies a service.
Open End Port	This is the last port number that identifies a service.
Open Proto.	This is the open transport layer protocol.
Modify	Click the Edit icon to edit this rule. Click the Delete icon to delete an existing rule.

11.4.1 Add/Edit Port Triggering Rule

This screen lets you create new port triggering rules. Click **Add new rule** in the **Port Triggering** screen or click a rule's **Edit** icon to open the following screen.

Figure 83 Port Triggering: Add/Edit

The following table describes the labels in this screen.

Table 59 Port Triggering: Configuration Add/Edit

LABEL	DESCRIPTION
Active	Select the check box to enable this rule.
Service Name	Enter a name to identify this rule using keyboard characters (A-Z, a-z, 1-2 and so on).
WAN Interface	Select a WAN interface for which you want to configure port triggering rules.
Trigger Start Port	The trigger port is a port (or a range of ports) that causes (or triggers) the Device to record the IP address of the LAN computer that sent the traffic to a server on the WAN. Type a port number or the starting port number in a range of port numbers.
Trigger End Port	Type a port number or the ending port number in a range of port numbers.
Trigger Protocol	Select the transport layer protocol from TCP , UDP , or TCP/UDP .
Open Start Port	The open port is a port (or a range of ports) that a server on the WAN uses when it sends out a particular service. The Device forwards the traffic with this port (or range of ports) to the client computer on the LAN that requested the service. Type a port number or the starting port number in a range of port numbers.
Open End Port	Type a port number or the ending port number in a range of port numbers.
Open Protocol	Select the transport layer protocol from TCP , UDP , or TCP/UDP .
OK	Click OK to save your changes.
Cancel	Click Cancel to exit this screen without saving.

11.5 The DMZ Screen

In addition to the servers for specified services, NAT supports a default server IP address. A default server receives packets from ports that are not specified in the **NAT Port Forwarding Setup** screen.

Figure 84 Network Setting > NAT > DMZ

The following table describes the fields in this screen.

Table 60 Network Setting > NAT > DMZ

LABEL	DESCRIPTION
Default Server Address	Enter the IP address of the default server which receives packets from ports that are not specified in the NAT Port Forwarding screen. Note: If you do not assign a Default Server Address , the Device discards all packets received for ports that are not specified in the NAT Port Forwarding screen.
Apply	Click Apply to save your changes.
Cancel	Click Cancel to restore your previously saved settings.

11.6 The ALG Screen

Some NAT routers may include a SIP Application Layer Gateway (ALG). A SIP ALG allows SIP calls to pass through NAT by examining and translating IP addresses embedded in the data stream. When the Device registers with the SIP register server, the SIP ALG translates the Device's private IP address inside the SIP data stream to a public IP address. You do not need to use STUN or an outbound proxy if your Device is behind a SIP ALG.

Use this screen to enable and disable the NAT and SIP (VoIP) ALG in the Device. To access this screen, click **Network Setting > NAT > ALG**.

Figure 85 Network Setting > NAT > ALG

The following table describes the fields in this screen.

Table 61 Network Setting > NAT > ALG

LABEL	DESCRIPTION
NAT ALG	Enable this to make sure applications such as FTP and file transfer in IM applications work correctly with port-forwarding and address-mapping rules.
SIP ALG	Enable this to make sure SIP (VoIP) works correctly with port-forwarding and address-mapping rules.
RTSP ALG	Enable this to have the Device detect RTSP traffic and help build RTSP sessions through its NAT. The Real Time Streaming (media control) Protocol (RTSP) is a remote control for multimedia on the Internet.
Apply	Click Apply to save your changes.
Cancel	Click Cancel to restore your previously saved settings.

11.7 The Address Mapping Screen

Ordering your rules is important because the Device applies the rules in the order that you specify. When a rule matches the current packet, the Device takes the corresponding action and the remaining rules are ignored.

Click **Network Setting > NAT > Address Mapping** to display the following screen.

Figure 86 Network Setting > NAT > Address Mapping

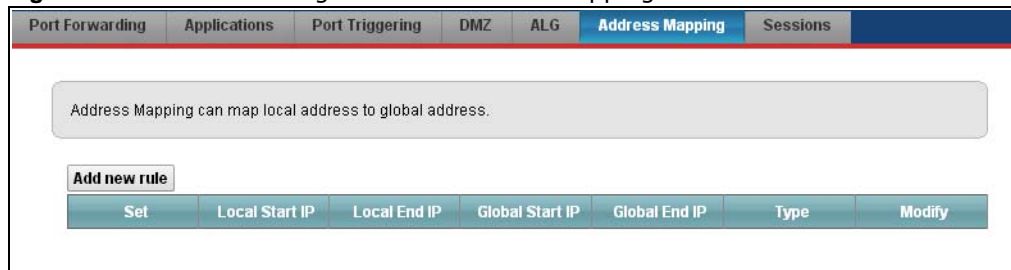

The following table describes the fields in this screen.

Table 62 Network Setting > NAT > Address Mapping

LABEL	DESCRIPTION
Add new rule	Click this to create a new rule.
Set	This is the index number of the address mapping set.
Local Start IP	This is the starting Inside Local IP Address (ILA).
Local End IP	This is the ending Inside Local IP Address (ILA). If the rule is for all local IP addresses, then this field displays 0.0.0.0 as the Local Start IP address and 255.255.255.255 as the Local End IP address. This field is blank for One-to-One mapping types.
Global Start IP	This is the starting Inside Global IP Address (IGA). Enter 0.0.0.0 here if you have a dynamic IP address from your ISP. You can only do this for the Many-to-One mapping type.
Global End IP	This is the ending Inside Global IP Address (IGA). This field is blank for One-to-One and Many-to-One mapping types.

Table 62 Network Setting > NAT > Address Mapping (continued)

LABEL	DESCRIPTION
Type	<p>This is the address mapping type.</p> <p>One-to-One: This mode maps one local IP address to one global IP address. Note that port numbers do not change for the One-to-one NAT mapping type.</p> <p>Many-to-One: This mode maps multiple local IP addresses to one global IP address. This is equivalent to SUA (i.e., PAT, port address translation), the Device's Single User Account feature that previous routers supported only.</p> <p>Many-to-Many: This mode maps multiple local IP addresses to shared global IP addresses.</p>
Modify	<p>Click the Edit icon to go to the screen where you can edit the address mapping rule.</p> <p>Click the Delete icon to delete an existing address mapping rule. Note that subsequent address mapping rules move up by one when you take this action.</p>

11.7.1 Add/Edit Address Mapping Rule

To add or edit an address mapping rule, click **Add new rule** or the rule's edit icon in the **Address Mapping** screen to display the screen shown next.

Figure 87 Address Mapping: Add/Edit

The following table describes the fields in this screen.

Table 63 Address Mapping: Add/Edit

LABEL	DESCRIPTION
Type	<p>Choose the IP/port mapping type from one of the following.</p> <p>One-to-One: This mode maps one local IP address to one global IP address. Note that port numbers do not change for the One-to-one NAT mapping type.</p> <p>Many-to-One: This mode maps multiple local IP addresses to one global IP address. This is equivalent to SUA (i.e., PAT, port address translation), the Device's Single User Account feature that previous routers supported only.</p> <p>Many-to-Many: This mode maps multiple local IP addresses to shared global IP addresses.</p>
Local Start IP	Enter the starting Inside Local IP Address (ILA).

Table 63 Address Mapping: Add/Edit (continued)

LABEL	DESCRIPTION
Local End IP	Enter the ending Inside Local IP Address (ILA). If the rule is for all local IP addresses, then this field displays 0.0.0.0 as the Local Start IP address and 255.255.255.255 as the Local End IP address. This field is blank for One-to-One mapping types.
Global Start IP	Enter the starting Inside Global IP Address (IGA). Enter 0.0.0.0 here if you have a dynamic IP address from your ISP. You can only do this for the Many-to-One mapping type.
Global End IP	Enter the ending Inside Global IP Address (IGA). This field is blank for One-to-One and Many-to-One mapping types.
Set	Select the number of the mapping set for which you want to configure.
OK	Click OK to save your changes.
Cancel	Click Cancel to exit this screen without saving.

11.8 The Sessions Screen

Use this screen to limit the number of concurrent NAT sessions a client can use. Click **Network Setting > NAT > Sessions** to display the following screen.

Figure 88 Network Setting > NAT > Sessions

The following table describes the fields in this screen.

Table 64 Network Setting > NAT > Sessions

LABEL	DESCRIPTION
WAX NAT Session Per Host	Use this field to set a limit to the number of concurrent NAT sessions each client host can have. If only a few clients use peer to peer applications, you can raise this number to improve their performance. With heavy peer-to-peer application use, lower this number to ensure no single client uses too many of the available NAT sessions.
Apply	Click this to save your changes on this screen.
Cancel	Click this to exit this screen without saving any changes.

11.9 Technical Reference

This part contains more information regarding NAT.

11.9.1 NAT Definitions

Inside/outside denotes where a host is located relative to the Device, for example, the computers of your subscribers are the inside hosts, while the web servers on the Internet are the outside hosts.

Global/local denotes the IP address of a host in a packet as the packet traverses a router, for example, the local address refers to the IP address of a host when the packet is in the local network, while the global address refers to the IP address of the host when the same packet is traveling in the WAN side.

Note that inside/outside refers to the location of a host, while global/local refers to the IP address of a host used in a packet. Thus, an inside local address (ILA) is the IP address of an inside host in a packet when the packet is still in the local network, while an inside global address (IGA) is the IP address of the same inside host when the packet is on the WAN side. The following table summarizes this information.

Table 65 NAT Definitions

ITEM	DESCRIPTION
Inside	This refers to the host on the LAN.
Outside	This refers to the host on the WAN.
Local	This refers to the packet address (source or destination) as the packet travels on the LAN.
Global	This refers to the packet address (source or destination) as the packet travels on the WAN.

NAT never changes the IP address (either local or global) of an outside host.

11.9.2 What NAT Does

In the simplest form, NAT changes the source IP address in a packet received from a subscriber (the inside local address) to another (the inside global address) before forwarding the packet to the WAN side. When the response comes back, NAT translates the destination address (the inside global address) back to the inside local address before forwarding it to the original inside host. Note that the IP address (either local or global) of an outside host is never changed.

The global IP addresses for the inside hosts can be either static or dynamically assigned by the ISP. In addition, you can designate servers, for example, a web server and a telnet server, on your local network and make them accessible to the outside world. If you do not define any servers (for Many-to-One and Many-to-Many Overload mapping), NAT offers the additional benefit of firewall protection. With no servers defined, your Device filters out all incoming inquiries, thus preventing intruders from probing your network. For more information on IP address translation, refer to *RFC 1631, The IP Network Address Translator (NAT)*.

11.9.3 How NAT Works

Each packet has two addresses – a source address and a destination address. For outgoing packets, the ILA (Inside Local Address) is the source address on the LAN, and the IGA (Inside Global Address) is the source address on the WAN. For incoming packets, the ILA is the destination address on the LAN, and the IGA is the destination address on the WAN. NAT maps private (local) IP addresses to globally unique ones required for communication with hosts on other networks. It replaces the original IP source address (and TCP or UDP source port numbers for Many-to-One and Many-to-Many Overload NAT mapping) in each packet and then forwards it to the Internet. The Device keeps track of the original addresses and port numbers so incoming reply packets can have their original values restored. The following figure illustrates this.

Figure 89 How NAT Works

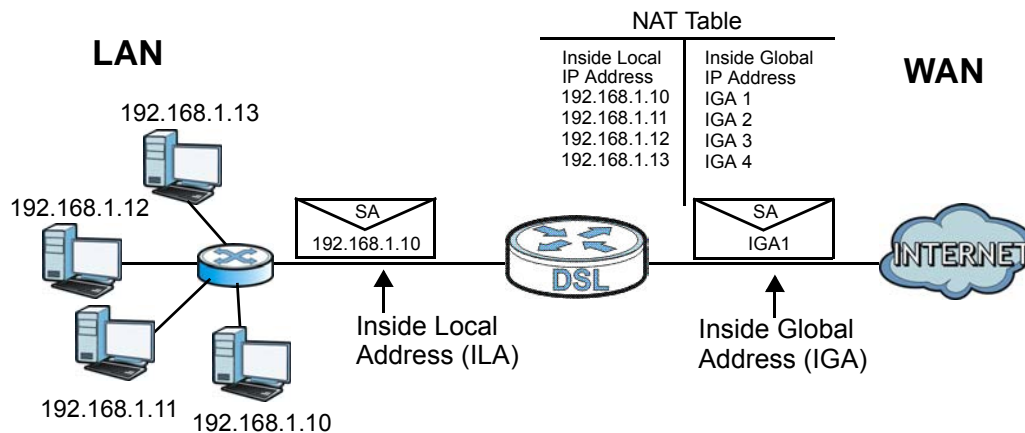

11.9.4 NAT Application

The following figure illustrates a possible NAT application, where three inside LANs (logical LANs using IP alias) behind the Device can communicate with three distinct WAN networks.

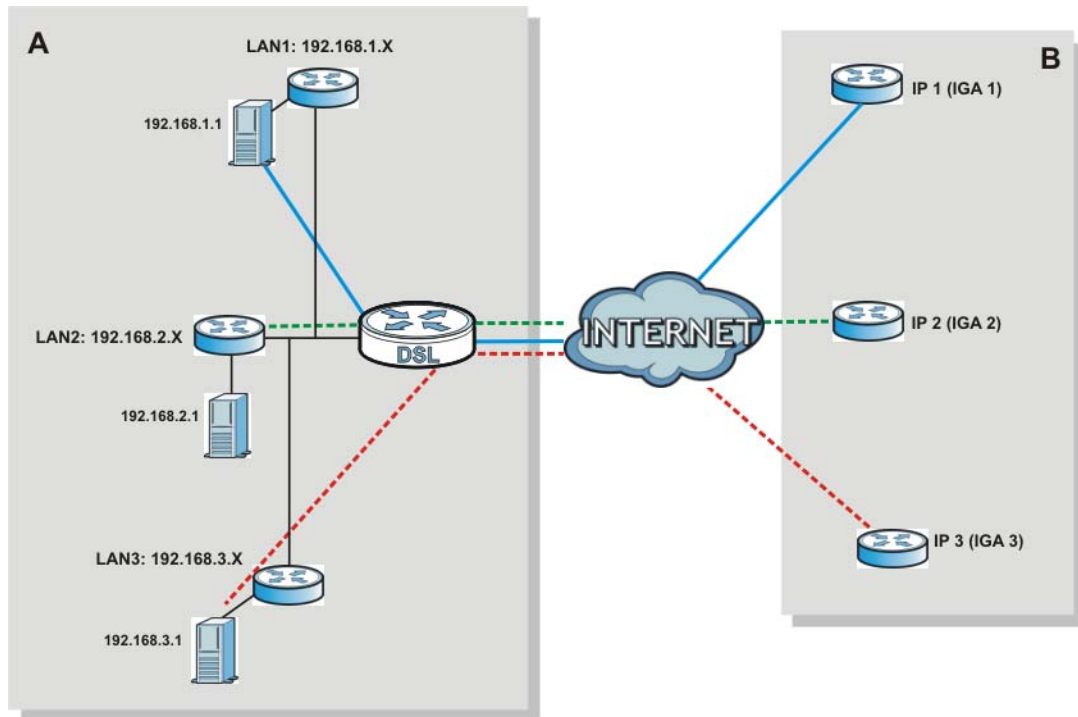
Figure 90 NAT Application With IP Alias

Port Forwarding: Services and Port Numbers

The most often used port numbers are shown in the following table. Please refer to RFC 1700 for further information about port numbers. Please also refer to the Supporting CD for more examples and details on port forwarding and NAT.

Table 66 Services and Port Numbers

SERVICES	PORT NUMBER
ECHO	7
FTP (File Transfer Protocol)	21
SMTP (Simple Mail Transfer Protocol)	25
DNS (Domain Name System)	53
Finger	79
HTTP (Hyper Text Transfer protocol or WWW, Web)	80
POP3 (Post Office Protocol)	110
NNTP (Network News Transport Protocol)	119
SNMP (Simple Network Management Protocol)	161
SNMP trap	162
PPTP (Point-to-Point Tunneling Protocol)	1723

Port Forwarding Example

Let's say you want to assign ports 21-25 to one FTP, Telnet and SMTP server (**A** in the example), port 80 to another (**B** in the example) and assign a default server IP address of 192.168.1.35 to a

third (C in the example). You assign the LAN IP addresses and the ISP assigns the WAN IP address. The NAT network appears as a single host on the Internet.

Figure 91 Multiple Servers Behind NAT Example

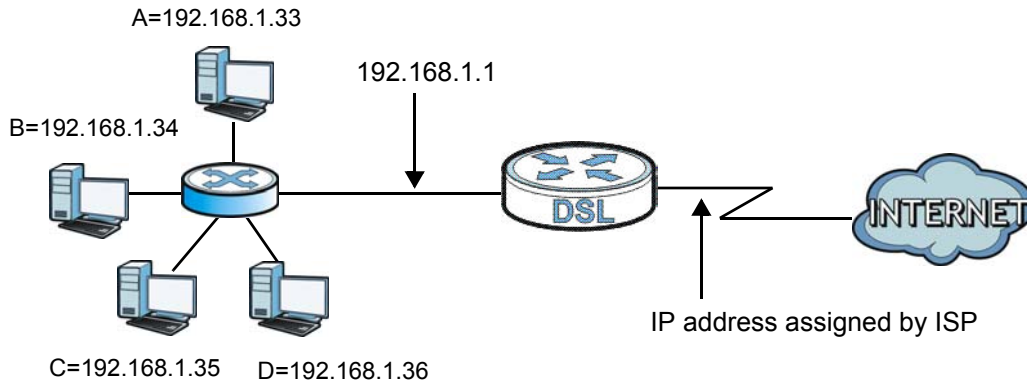

Dynamic DNS Setup

12.1 Overview

DNS

DNS (Domain Name System) is for mapping a domain name to its corresponding IP address and vice versa. The DNS server is extremely important because without it, you must know the IP address of a machine before you can access it.

In addition to the system DNS server(s), each WAN interface (service) is set to have its own static or dynamic DNS server list. You can configure a DNS static route to forward DNS queries for certain domain names through a specific WAN interface to its DNS server(s). The Device uses a system DNS server (in the order you specify in the **Broadband** screen) to resolve domain names that do not match any DNS routing entry. After the Device receives a DNS reply from a DNS server, it creates a new entry for the resolved IP address in the routing table.

Dynamic DNS

Dynamic DNS allows you to update your current dynamic IP address with one or many dynamic DNS services so that anyone can contact you (in NetMeeting, CU-SeeMe, etc.). You can also access your FTP server or Web site on your own computer using a domain name (for instance myhost.dhs.org, where myhost is a name of your choice) that will never change instead of using an IP address that changes each time you reconnect. Your friends or relatives will always be able to call you even if they don't know your IP address.

First of all, you need to have registered a dynamic DNS account with www.dyndns.org. This is for people with a dynamic IP from their ISP or DHCP server that would still like to have a domain name. The Dynamic DNS service provider will give you a password or key.

12.1.1 What You Can Do in this Chapter

- Use the **DNS Entry** screen to view, configure, or remove DNS routes ([Section 12.2 on page 183](#)).
- Use the **Dynamic DNS** screen to enable DDNS and configure the DDNS settings on the Device ([Section 12.3 on page 184](#)).

12.1.2 What You Need To Know

DYNDNS Wildcard

Enabling the wildcard feature for your host causes *.yourhost.dyndns.org to be aliased to the same IP address as yourhost.dyndns.org. This feature is useful if you want to be able to use, for example, www.yourhost.dyndns.org and still reach your hostname.

If you have a private WAN IP address, then you cannot use Dynamic DNS.

12.2 The DNS Entry Screen

Use this screen to view and configure DNS routes on the Device. Click **Network Setting > DNS** to open the **DNS Entry** screen.

Figure 92 Network Setting > DNS > DNS Entry

Domain Name System (DNS) translates hostnames into IP addresses for the purpose of locating and addressing these devices worldwide. You can start by adding a new DNS entry.

Add new DNS entry

#	Hostname	IP Address	Modify
---	----------	------------	--------

Notes:
The hostnames needs combination of the host's local name with its domain's name. For example, Mycomputer.home consists of a local hostname (Mycomputer) and the domain name (home).

The following table describes the fields in this screen.

Table 67 Network Setting > DNS > DNS Entry

LABEL	DESCRIPTION
Add new DNS entry	Click this to create a new DNS entry.
#	This is the index number of the entry.
Hostname	This indicates the host name or domain name.
IP Address	This indicates the IP address assigned to this computer.
Modify	Click the Edit icon to edit the rule. Click the Delete icon to delete an existing rule.

12.2.1 Add/Edit DNS Entry

You can manually add or edit the Device's DNS name and IP address entry. Click **Add new DNS entry** in the **DNS Entry** screen or the **Edit** icon next to the entry you want to edit. The screen shown next appears.

Figure 93 DNS Entry: Add/Edit

DNS Entry Configuration

Host Name :

IPv4 Address :

Apply Cancel

The following table describes the labels in this screen.

Table 68 DNS Entry: Add/Edit

LABEL	DESCRIPTION
Host Name	Enter the host name of the DNS entry.
IP Address	Enter the IP address of the DNS entry.
Apply	Click Apply to save your changes.
Cancel	Click Cancel to exit this screen without saving.

12.3 The Dynamic DNS Screen

Use this screen to change your Device's DDNS. Click **Network Setting > DNS > Dynamic DNS**. The screen appears as shown.

Figure 94 Network Setting > DNS > Dynamic DNS

The following table describes the fields in this screen.

Table 69 Network Setting > DNS > > Dynamic DNS

LABEL	DESCRIPTION
Dynamic DNS Setup	
Dynamic DNS	Select Enable to use dynamic DNS.
Service Provider	Select your Dynamic DNS service provider from the drop-down list box.
Hostname	Type the domain name assigned to your Device by your Dynamic DNS provider. You can specify up to two host names in the field separated by a comma (",").
Username	Type your user name.
Password	Type the password assigned to you.
Dynamic DNS Status	
User Authentication Result	This shows Success if the account is correctly set up with the Dynamic DNS provider account.

Table 69 Network Setting > DNS > > Dynamic DNS (continued)

LABEL	DESCRIPTION
Last Updated Time	This shows the last time the IP address the Dynamic DNS provider has associated with the hostname was updated.
Current Dynamic IP	This shows the IP address your Dynamic DNS provider has currently associated with the hostname.
Apply	Click Apply to save your changes.
Cancel	Click Cancel to exit this screen without saving.

13.1 Overview

Use the **IGMP/MLD** screen to configure IGMP/MLD group settings.

13.1.1 What You Need To Know

Multicast and IGMP

See [Multicast on page 92](#) for more information.

Multicast Listener Discovery (MLD)

The Multicast Listener Discovery (MLD) protocol (defined in RFC 2710) is derived from IPv4's Internet Group Management Protocol version 2 (IGMPv2). MLD uses ICMPv6 message types, rather than IGMP message types. MLDv1 is equivalent to IGMPv2 and MLDv2 is equivalent to IGMPv3.

- MLD allows an IPv6 switch or router to discover the presence of MLD hosts who wish to receive multicast packets and the IP addresses of multicast groups the hosts want to join on its network.
- MLD snooping and MLD proxy are analogous to IGMP snooping and IGMP proxy in IPv4.
- MLD filtering controls which multicast groups a port can join.
- An MLD Report message is equivalent to an IGMP Report message, and a MLD Done message is equivalent to an IGMP Leave message.

IGMP Fast Leave

When a host leaves a multicast group (224.1.1.1), it sends an IGMP leave message to inform all routers (224.0.0.2) in the multicast group. When a router receives the leave message, it sends a specific query message to all multicast group (224.1.1.1) members to check if any other hosts are still in the group. Then the router deletes the host's information.

With the IGMP fast leave feature enabled, the router removes the host's information from the group member list once it receives a leave message from a host and the fast leave timer expires.

13.2 The IGMP/MLD Screen

Use this screen to configure multicast groups the Device has joined and which ports have joined it. To open this screen, click **Network Setting > IGMP/MLD**.

Figure 95 Network Setting > IGMP/MLD

IGMP/MLD

Enter IGMP/MLD protocol configuration fields if you want modify default values shown below

IGMP Configuration

Default Version :

Query Interval :

Query Response Interval :

Last Member Query Interval :

Robustness Value :

Maximum Multicast Groups :

Maximum Multicast Data Sources (for IGMPv3) :

(1 - 24) :

Maximum Multicast Group Members :

Fast Leave Enable :

LAN to LAN (Intra LAN) Multicast Enable :

Membership Join Immediate (IPTV) :

MLD Configuration

Default Version :

Query Interval :

Query Response Interval :

Last Member Query Interval :

Robustness Value :

Maximum Multicast Groups :

Maximum Multicast Data Sources (for mldv2) :

Maximum Multicast Group Members :

Fast Leave Enable :

LAN to LAN (Intra LAN) Multicast Enable :

The following table describes the labels in this screen.

Table 70 Network Setting > IGMP/MLD

LABEL	DESCRIPTION
IGMP/MLD Configuration	
Default Version	Enter the version of IGMP (1~3) and MLD (1~2) that you want the Device to use on the WAN.
Query Interval	Enter the number of seconds the Device sends a query message to hosts to get the group membership information.
Query Response Interval	Enter the maximum number of seconds the Device can wait for receiving a General Query message. Multicast routers use general queries to learn which multicast groups have members.
Last Member Query Interval	Enter the maximum number of seconds the Device can wait for receiving a response to a Group-Specific Query message. Multicast routers use group-specific queries to learn whether any member remains in a specific multicast group.
Robustness Value	Enter the number of times (1~7) the Device can resend a packet if packet loss occurs due to network congestion.

Table 70 Network Setting > IGMP/MLD (continued)

LABEL	DESCRIPTION
Maximum Multicast Groups	Enter a number to limit the number of multicast groups an interface on the Device is allowed to join. Once a multicast member is registered in the specified number of multicast groups, any new IGMP or MLD join report frames are dropped by the interface.
Maximum Multicast Data Sources	Enter a number to limit the number of multicast data sources (1-24) a multicast group is allowed to have. Note: The setting only works for IGMPv3 and MLDv2.
Maximum Multicast Group Members	Enter a number to limit the number of multicast members a multicast group can have.
Fast Leave Enable	Select this option to set the Device to remove a port from the multicast tree immediately (without sending an IGMP or MLD membership query message) once it receives an IGMP or MLD leave message. This is helpful if a user wants to quickly change a TV channel (multicast group change) especially for IPTV applications.
LAN to LAN (Intra LAN) Multicast Enable	Select this to enable LAN to LAN IGMP snooping capability.
Membership Join Immediate (IPTV)	Select this to have the Device add a host to a multicast group immediately once the Device receives an IGMP or MLD join message.
Apply	Click Apply to save your changes back to the Device.
Cancel	Click Cancel to exit this screen without saving.

Vlan Group

14.1 Overview

Virtual LAN IDs are used to identify different traffic types over the same physical link.

In the following example, the Device (DSL) can use VLAN IDs (VID) 100 and 200 to identify Video-on-Demand and IPTV traffic respectively coming from the two VoD and IPTV multicast servers. The Device (DSL) can also tag outgoing requests to these servers with these VLAN IDs.

Figure 96 VLAN Group Example

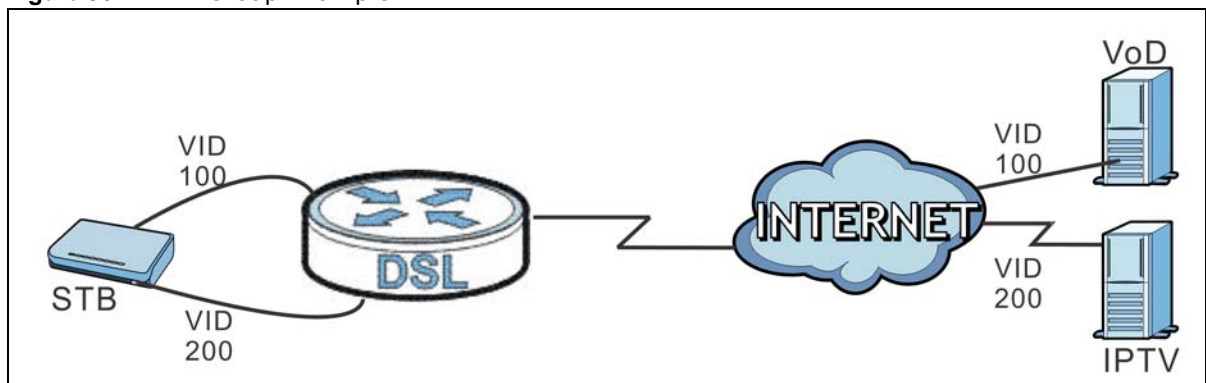

14.1.1 What You Can Do in this Chapter

Use these screens to group separate VLAN groups together to be treated as one VLAN group.

14.2 The Vlan Group Screen

Click **Network Setting > Vlan Group** to open the following screen.

Figure 97 Network Setting > Vlan Group

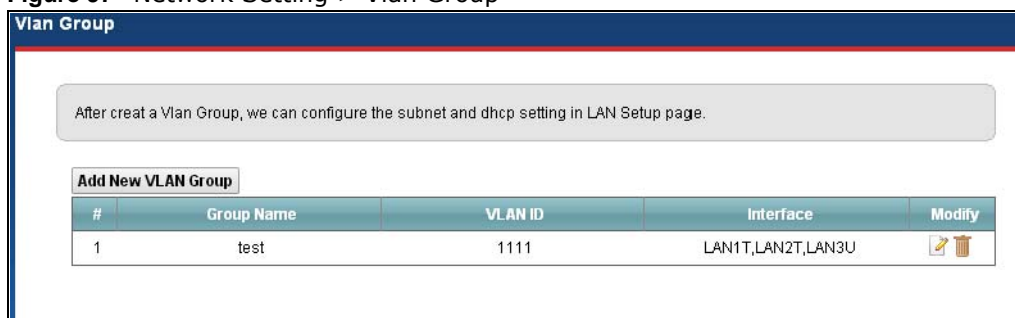

The following table describes the fields in this screen.

Table 71 Network Setting > Vlan Group

LABEL	DESCRIPTION
Add New Vlan Group	Click this button to create a new VLAN group.
#	This is the index number of the VLAN group.
Group Name	This shows the descriptive name of the VLAN group.
VLAN ID	This shows the unique ID number that identifies the VLAN group.
Interfaces	This shows the LAN ports included in the VLAN group and if traffic leaving the port will be tagged with the VLAN ID.
Modify	Click the Edit icon to change an existing VLAN group setting or click the Delete icon to remove the VLAN group.

14.2.1 Add/Edit a VLAN Group

Click the **Add New VLAN Group** button in the **Vlan Group** screen to open the following screen. Use this screen to create a new VLAN group.

Figure 98 Add/Edit VLAN Group

The following table describes the fields in this screen.

Table 72 Add/Edit VLAN Group

LABEL	DESCRIPTION
VLAN Group Name	Enter a name to identify this group. You can enter up to 30 characters. You can use letters, numbers, hyphens (-) and underscores (_). Spaces are not allowed.
VLAN ID	Enter a unique ID number, from 1 to 4,094, to identify this VLAN group. Outgoing traffic is tagged with this ID if Tx tagging is selected below.
LAN	Select Include to add the associated LAN interface to this VLAN group. Select Tx tagging to tag outgoing traffic from the associated LAN port with the VLAN ID number entered above.
Apply	Click Apply to save your changes back to the Device.
Cancel	Click Cancel to exit this screen without saving.

Interface Group

15.1 Overview

By default, all LAN and WAN interfaces on the Device are in the same group and can communicate with each other. Create interface groups to have the Device assign the IP addresses in different domains to different groups. Each group acts as an independent network on the Device. This lets devices connected to an interface group's LAN interfaces communicate through the interface group's WAN or LAN interfaces but not other WAN or LAN interfaces.

15.1.1 What You Can Do in this Chapter

The **Interface Group** screens let you create multiple networks on the Device ([Section 15.2 on page 191](#)).

15.2 The Interface Group Screen

You can manually add a LAN interface to a new group. Alternatively, you can have the Device automatically add the incoming traffic and the LAN interface on which traffic is received to an interface group when its DHCP Vendor ID option information matches one listed for the interface group.

Use the **LAN** screen to configure the private IP addresses the DHCP server on the Device assigns to the clients in the default and/or user-defined groups. If you set the Device to assign IP addresses based on the client's DHCP Vendor ID option information, you must enable DHCP server and configure LAN TCP/IP settings for both the default and user-defined groups. See [Chapter 8 on page 125](#) for more information.

In the following example, the client that sends packets with the DHCP Vendor ID option set to MSFT 5.0 (meaning it is a Windows 2000 DHCP client) is assigned the IP address 192.168.2.2 and uses the WAN VDSL_PoE/ppp0.1 interface.

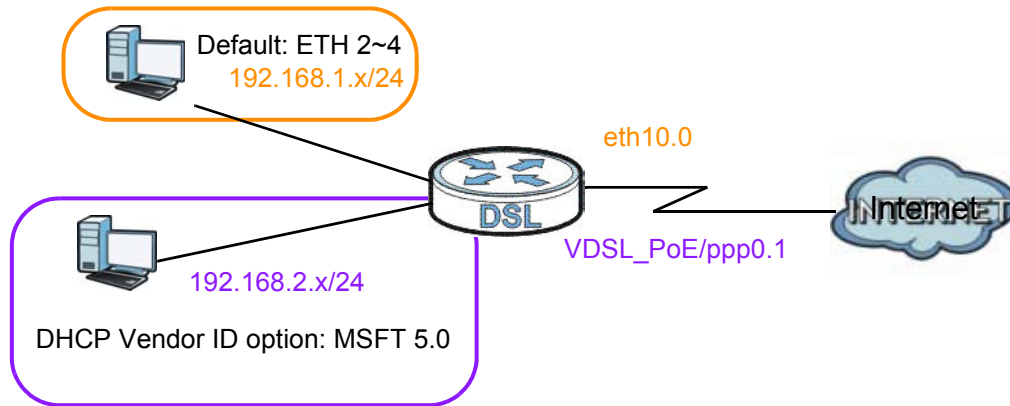
Figure 99 Interface Grouping Application

Click **Network Setting > Interface Group** to open the following screen.

Figure 100 Network Setting > Interface Group

Add New Interface Group				
Group Name	WAN Interface	LAN Interfaces	Criteria	Modify
Default	ptm0.1,atm0.1,eth4.1,ppp0.1...	LAN1,LAN2,LAN3,LAN4,Zy...		

The following table describes the fields in this screen.

Table 73 Network Setting > Interface Group

LABEL	DESCRIPTION
Add New Interface Group	Click this button to create a new interface group.
Group Name	This shows the descriptive name of the group.
WAN Interface	This shows the WAN interfaces in the group.
LAN Interfaces	This shows the LAN interfaces in the group.
Criteria	This shows the filtering criteria for the group.
Modify	Click the Delete icon to remove the group.
Add	Click this button to create a new group.

15.2.1 Interface Group Configuration

Click the **Add New Interface Group** button in the **Interface Group** screen to open the following screen. Use this screen to create a new interface group.

Note: An interface can belong to only one group at a time.

Figure 101 Interface Group Configuration

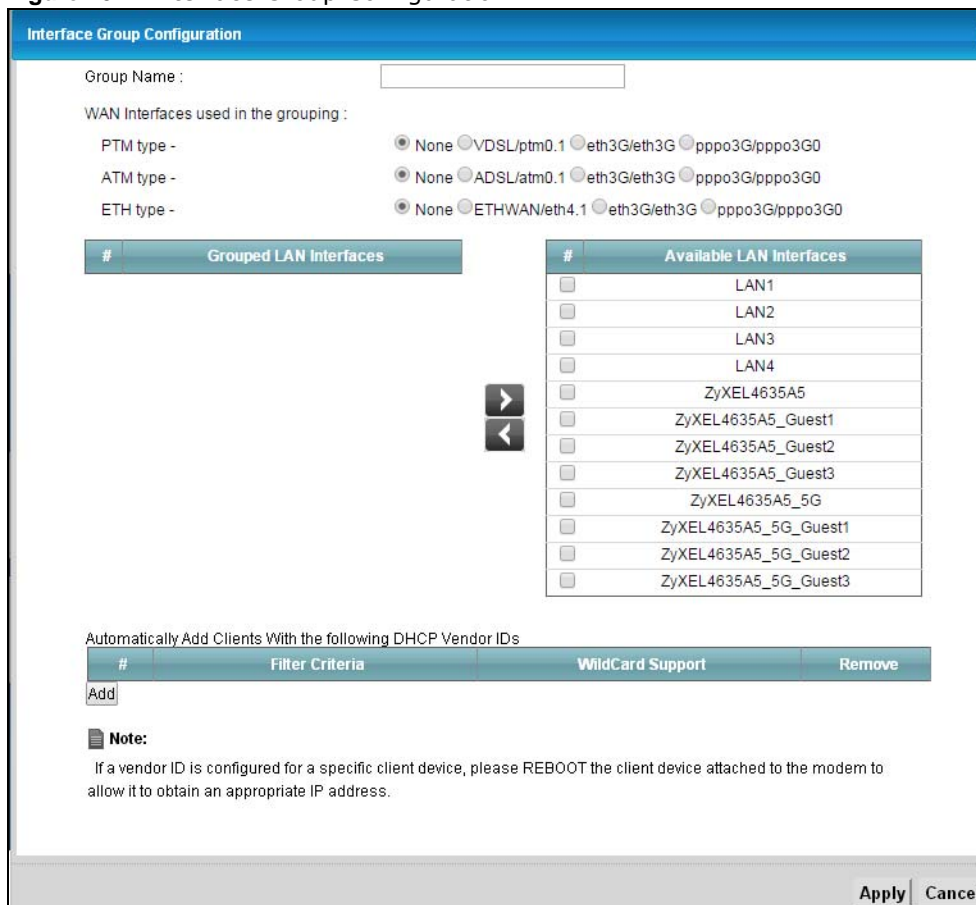

The following table describes the fields in this screen.

Table 74 Interface Group Configuration

LABEL	DESCRIPTION
Group Name	Enter a name to identify this group. You can enter up to 30 characters. You can use letters, numbers, hyphens (-) and underscores (_). Spaces are not allowed.
WAN Interface used in the grouping	Select the WAN interface this group uses. The group can have up to one PTM interface, up to one ATM interface and up to one ETH interface. Select None to not add a WAN interface to this group.
Grouped LAN Interfaces Available LAN Interfaces	Select one or more LAN interfaces (Ethernet LAN, HPNA or wireless LAN) in the Available LAN Interfaces list and use the left arrow to move them to the Grouped LAN Interfaces list to add the interfaces to this group. To remove a LAN or wireless LAN interface from the Grouped LAN Interfaces , use the right-facing arrow.
Automatically Add Clients With the following DHCP Vendor IDs	Click Add to identify LAN hosts to add to the interface group by criteria such as the type of the hardware or firmware. See Section 15.2.2 on page 194 for more information.
#	This shows the index number of the rule.
Filter Criteria	This shows the filtering criteria. The LAN interface on which the matched traffic is received will belong to this group automatically.

Table 74 Interface Group Configuration (continued)

LABEL	DESCRIPTION
WildCard Support	This shows if wildcard on DHCP option 60 is enabled.
Remove	Click the Remove icon to delete this rule from the Device.
Apply	Click Apply to save your changes back to the Device.
Cancel	Click Cancel to exit this screen without saving.

15.2.2 Interface Grouping Criteria

Click the **Add** button in the **Interface Grouping Configuration** screen to open the following screen.

Figure 102 Interface Grouping Criteria

The following table describes the fields in this screen.

Table 75 Interface Grouping Criteria

LABEL	DESCRIPTION
Source MAC Address	Enter the source MAC address of the packet.
DHCP Option 60	Select this option and enter the Vendor Class Identifier (Option 60) of the matched traffic, such as the type of the hardware or firmware.
Enable wildcard on DHCP option 60 option	Select this option to be able to use wildcards in the Vendor Class Identifier configured for DHCP option 60.
DHCP Option 61	Select this and enter the device identity of the matched traffic.
IAID	Enter the Identity Association Identifier (IAID) of the device, for example, the WAN connection index number.

Table 75 Interface Grouping Criteria (continued)

LABEL	DESCRIPTION
DUID type	<p>Select DUID-LLT (DUID Based on Link-layer Address Plus Time) to enter the hardware type, a time value and the MAC address of the device.</p> <p>Select DUID-EN (DUID Assigned by Vendor Based upon Enterprise Number) to enter the vendor's registered enterprise number.</p> <p>Select DUID-LL (DUID Based on Link-layer Address) to enter the device's hardware type and hardware address (MAC address) in the following fields.</p> <p>Select Other to enter any string that identifies the device in the DUID field.</p>
DHCP Option 125	Select this and enter vendor specific information of the matched traffic.
Enterprise Number	Enter the vendor's 32-bit enterprise number registered with the IANA (Internet Assigned Numbers Authority).
Manufacturer OUI	Specify the vendor's OUI (Organization Unique Identifier). It is usually the first three bytes of the MAC address.
Product Class	Enter the product class of the device.
Model Name	Enter the model name of the device.
Serial Number	Enter the serial number of the device.
Apply	Click Apply to save your changes back to the Device.
Cancel	Click Cancel to exit this screen without saving.

USB Service

16.1 Overview

You can share files on a USB memory stick or hard drive connected to your Device with users on your network.

The following figure is an overview of the Device's file server feature. Computers **A** and **B** can access files on a USB device (**C**) which is connected to the Device.

Figure 103 File Sharing Overview

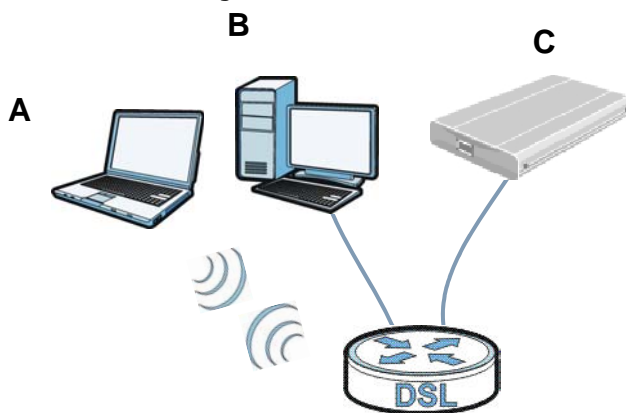

The Device will not be able to join the workgroup if your local area network has restrictions set up that do not allow devices to join a workgroup. In this case, contact your network administrator.

16.1.1 What You Can Do in this Chapter

- Use the **File Sharing** screen to enable file-sharing server ([Section 16.1.3 on page 198](#)).
- Use the **Media Server** screen to enable or disable the sharing of media files ([Section 16.3 on page 200](#)).
- Use the **Printer Server** screen to enable the print server ([Section 16.4 on page 201](#)).

16.1.2 What You Need To Know

The following terms and concepts may help as you read this chapter.

16.1.2.1 About File Sharing

Workgroup name

This is the name given to a set of computers that are connected on a network and share resources such as a printer or files. Windows automatically assigns the workgroup name when you set up a network.

Shares

When settings are set to default, each USB device connected to the Device is given a folder, called a "share". If a USB hard drive connected to the Device has more than one partition, then each partition will be allocated a share. You can also configure a "share" to be a sub-folder or file on the USB device.

File Systems

A file system is a way of storing and organizing files on your hard drive and storage device. Often different operating systems such as Windows or Linux have different file systems. The file sharing feature on your Device supports File Allocation Table (FAT) and FAT32.

Common Internet File System

The Device uses Common Internet File System (CIFS) protocol for its file sharing functions. CIFS compatible computers can access the USB file storage devices connected to the Device. CIFS protocol is supported on Microsoft Windows, Linux Samba and other operating systems (refer to your systems specifications for CIFS compatibility).

16.1.2.2 About Printer Server

Print Server

This is a computer or other device which manages one or more printers, and which sends print jobs to each printer from the computer itself or other devices.

Operating System

An operating system (OS) is the interface which helps you manage a computer. Common examples are Microsoft Windows, Mac OS or Linux.

TCP/IP

TCP/IP (Transmission Control Protocol/ Internet Protocol) is a set of communications protocols that most of the Internet runs on.

Port

A port maps a network service such as http to a process running on your computer, such as a process run by your web browser. When traffic from the Internet is received on your computer, the port number is used to identify which process running on your computer it is intended for.

Supported OSs

Your operating system must support TCP/IP ports for printing and be compatible with the RAW (port 9100) protocol.

The following OSs support Device's printer sharing feature.

- Microsoft Windows 95, Windows 98 SE (Second Edition), Windows Me, Windows NT 4.0, Windows 2000, Windows XP or Macintosh OS X.

16.1.3 Before You Begin

Make sure the Device is connected to your network and turned on.

- 1 Connect the USB device to one of the Device's USB port. Make sure the Device is connected to your network.
- 2 The Device detects the USB device and makes its contents available for browsing. If you are connecting a USB hard drive that comes with an external power supply, make sure it is connected to an appropriate power source that is on.

Note: If your USB device cannot be detected by the Device, see the troubleshooting for suggestions.

16.2 The File Sharing Screen

Use this screen to set up file sharing through the Device. The Device's LAN users can access the shared folder (or share) from the USB device inserted in the Device. To access this screen, click **Network Setting > USB Service > File Sharing**.

Figure 104 Network Setting > USB Service > File Sharing

The device can share files from your USB flash drive or disk when you attach it to the USB port. You may start from deciding which folders in the USB disks to share and which users can access the shared folders.

Information

Volume	Capacity	Used Space
	0	0

Server Configuration

File Sharing Services: Enable Disable





Host Name:

Account Management

Active	Status	User Name	Modify
--------	--------	-----------	--------

Each field is described in the following table.

Table 76 Network Setting > USB Service > File Sharing

LABEL	DESCRIPTION
Information	
Volume	This is the volume name the Device gives to an inserted USB device.
Capacity	This is the total available memory size (in megabytes) on the USB device.
Used Space	This is the memory size (in megabytes) already used on the USB device.
Server Configuration	
File Sharing Services	Select Enable to activate file sharing through the Device.
Host Name	Enter the host name on the share.
Share Directory List	
Add New Share	Click this to create a new share for users to access through the Device.
Active	Select this to activate the share.
Status	This field shows the status of the share.  : The share is not activated.  : The share is activated and shared to all users.  : The share is activated and only shared to the specified users listed in the Account Management section below.
Share Name	This field shows the name of a folder that is shared through the Device.
Share Path	This field shows the location of the share in the Device.
Share Description	This field shows a short description of the share.
Modify	Click the Edit icon to modify the share. Click the Delete icon to remove the share from the Device.
Account Management	
Add New User	Click this button to create a user account to access the secured shares.
Active	Select this to allow the user to access the secured shares.
Status	This field shows the status of the user.  : The user account is not activated for the share.  : The user account is activated for the share.
User Name	This is the name of a user who is allowed to access the secured shares on the USB device.
Modify	Click the Edit icon to modify the user account. Click the Delete icon to remove the user account from the Device.
Apply	Click this to save your changes to the Device.
Cancel	Click this to restore your previously saved settings.

16.2.1 The Add New User Screen

Use this screen to create a user account that can access the secured shares on the USB device. To access this screen, click the **Add New User** button in the **Network Setting > USB Service > File Sharing** screen.

Figure 105 Network Setting > USB Service > File Sharing > Add new user

Each field is described in the following table.

Table 77 Network Setting > USB Service > File Sharing > Add new user

LABEL	DESCRIPTION
User Name	Enter a user name. You can enter up to 16 characters. Only letters and numbers allowed.
New Password	Enter the password used to access the secured share. The password must be 5 to 15 characters long. Only letters and numbers are allowed. The password is case sensitive.
Retype New Password	Retype the password that you entered above.
Apply	Click this to save your changes to the Device.
Back	Click this to return to the previous screen.

16.3 The Media Server Screen

The media server feature lets anyone on your network play video, music, and photos from the USB storage device connected to your Device (without having to copy them to another computer). The Device can function as a DLNA-compliant media server. The Device streams files to DLNA-compliant media clients (like Windows Media Player). The Digital Living Network Alliance (DLNA) is a group of personal computer and electronics companies that works to make products compatible in a home network.

The Device media server enables you to:

- Publish all shares for everyone to play media files in the USB storage device connected to the Device.
- Use hardware-based media clients like the DMA-2500 to play the files.

Note: Anyone on your network can play the media files in the published shares. No user name and password or other form of security is used. The media server is enabled by default with the video, photo, and music shares published.

To change your Device's media server settings, click **Network Setting > USB Service > Media Server**. The screen appears as shown.

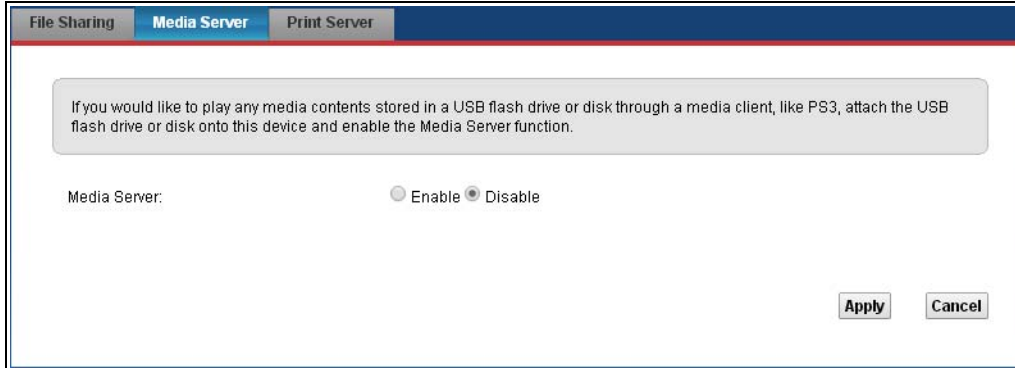
Figure 106 Network Setting > USB Service > Media Server

The following table describes the labels in this menu.

Table 78 Network Setting > USB Service > Media Server

LABEL	DESCRIPTION
Media Server	Select Enable to have the Device function as a DLNA-compliant media server. Enable the media server to let (DLNA-compliant) media clients on your network play media files located in the shares.
Interface	Select an interface on which you want to enable the media server function.
Media Library Path	Enter the path clients use to access the media files on a USB storage device connected to the Device.
Apply	Click Apply to save your changes.
Cancel	Click Cancel to restore your previously saved settings.

16.4 Print Server

The Device allows you to share a USB printer on your LAN. You can do this by connecting a USB printer to one of the USB ports on the Device and then configuring a TCP/IP port on the computers connected to your network.

16.4.1 Before You Begin

To configure the print server you need the following:

- Your Device must be connected to your computer and any other devices on your network. The USB printer must be connected to your Device.
- A USB printer with the driver already installed on your computer.
- The computers on your network must have the printer software already installed before they can create a TCP/IP port for printing via the network. Follow your printer manufacturers instructions on how to install the printer software on your computer.

Note: Your printer's installation instructions may ask that you connect the printer to your computer. Connect your printer to the Device instead.

16.4.2 The Print Server Screen

Use this screen to enable or disable sharing of a USB printer via your Device.

To access this screen, click **Network Setting > USB Service > Print Server**.

Figure 107 Network Setting > USB Service > Printer Server



The following table describes the labels in this menu.

Table 79 Network Setting > USB Service > Print Server

LABEL	DESCRIPTION
Print Server	Select Enable to have the Device share a USB printer.
Apply	Click Apply to save your changes.
Cancel	Click Cancel to restore your previously saved settings.

Power Management

17.1 Overview

Power management allows you to turn on/off one or more interfaces and all LED lights without power off the whole system when necessary. You can configure a schedule to do so automatically or manually do it on the Web Configurator.

17.1.1 What You Can Do in this Chapter

- Use the **Power Management** screen to manually turn on/off interface(s) and/or LEDs ([Section 17.2 on page 203](#)).
- Use the **Auto Switch Off** screen to configure schedules for turning on/off interface(s) and/or LEDs automatically ([Section 17.3 on page 204](#)).

17.1.2 What You Need To Know

- The **Power Management** and **Auto Switch Off** screens are dependant. You can only configure the on/off switches of the same interface and LEDs in one of the two screens.

17.2 The Power Management Screen

Use this screen to manually turn on/off interface(s) or LEDs. Click **Network Setting > Power Management > Power Management**. The screen appears as shown.

Figure 108 Network Setting > Power Management

Each field is described in the following table.

Table 80 Network Setting > Power Management

LABEL	DESCRIPTION
Manually Switch On/Off	Select POWER ON or POWER OFF to turn on/off the interface or LED lights.
Apply	Click Apply to save your changes.
Cancel	Click Cancel to restore your previously saved settings.

17.3 The Auto Switch Off Screen

Use this screen to view schedules to turn on or off specific interface(s) and/or all LED lights on the Device. To access this screen, click **Network Setting > Power Management > Auto Switch Off**.

Figure 109 Network Setting > Power Management > Auto Switch Off

The following table describes the labels in this menu.



Table 81 Network Setting > Power Management > Auto Switch Off Network Setting > Power Management > Auto Switch Off

LABEL	DESCRIPTION
Add or modify rules	Click this link to create or edit a schedule.
#	This is the index number of a schedule rule.
Rule Name	This field shows the name of the schedule rule.
Day	This field shows which week days (in green) the interface(s) and/or LEDs are turned on and the days (grayed-out) they are turned off automatically.
Time	This field shows the time period the interface(s) and/or LEDs are turned on.
Wireless	This field shows whether this schedule applies to the wireless LAN interface.
DSL WAN	This field shows whether this schedule applies to the DSL WAN interface.
Eth WAN	This field shows whether this schedule applies to the Ethernet WAN interface.
LAN1~LAN4	This field shows whether this schedule applies to the corresponding LAN interface.
LED	This field shows whether this schedule applies to the LEDs.
Apply	Click Apply to save your changes.
Cancel	Click Cancel to restore your previously saved settings.

17.3.1 The Auto Switch Off Add or Modify Screen

Use this screen to manage the auto switch off schedules. To access this screen, click the **Add or modify rules** link in the **Network Setting > Power Management > Auto Switch Off** screen.

Figure 110 Network Setting > Power Management > Auto Switch Off > Add or modify rules

#	Rule Name	Day	Time	Description	Modify
1	BedTime	S M T W T F S	00:00 - 07:00		 

The following table describes the labels in this menu.

Table 82 Network Setting > Power Management > Auto Switch Off Network Setting > Power Management > Auto Switch Off > Add or modify rules

LABEL	DESCRIPTION
Add new rule	Click this link to create a rule.
#	This is the index number of a rule.
Rule Name	This field shows the name of the rule.
Day	This field shows the week days of the schedule (in green).
Time	This field shows the time period of the schedule.
Description	This field shows more information about this rule.
Modify	Click the Edit icon to modify the rule or click the Delete icon to remove it.

17.3.2 The Add/Edit Rule Screen

Use this screen to configure a schedule rule. To access this screen, click the **Add new rule** link or the **Edit** icon in the **Network Setting > Power Management > Auto Switch Off > Add or modify rules** screen.

Figure 111 Network Setting > Power Management > Auto Switch Off > Add or modify rules > Add new rule/Edit

Each field is described in the following table.

Table 83 Network Setting > Power Management > Auto Switch Off > Add or modify rules > Add new rule/Edit>

LABEL	DESCRIPTION
Rule Name	Type up to 31 alphanumeric characters for the name of this rule.
Day	Select the week day(s) of the schedule.
Time of Day Range	Enter the From and To times (in hh:mm format) to set a time period for the schedule. You can only enter a time period between 00:00 and 23:59. To set a time period crossing over midnight, you must split the time period into two schedule rules. For example, for a time period from 10:00 PM to the next day's 8:00 AM, you can set one schedule for 22:00~23:59 and another schedule for 00:00~08:00.
Description	Enter more information for this rule here.
Apply	Click Apply to save your changes.
Cancel	Click Cancel to restore your previously saved settings.

18.1 Overview

This chapter shows you how to enable and configure the Device's security settings. Use the firewall to protect your Device and network from attacks by hackers on the Internet and control access to it. By default the firewall:

- allows traffic that originates from your LAN computers to go to all other networks.
- blocks traffic that originates on other networks from going to the LAN.

The following figure illustrates the default firewall action. User **A** can initiate an IM (Instant Messaging) session from the LAN to the WAN (1). Return traffic for this session is also allowed (2). However other traffic initiated from the WAN is blocked (3 and 4).

Figure 112 Default Firewall Action

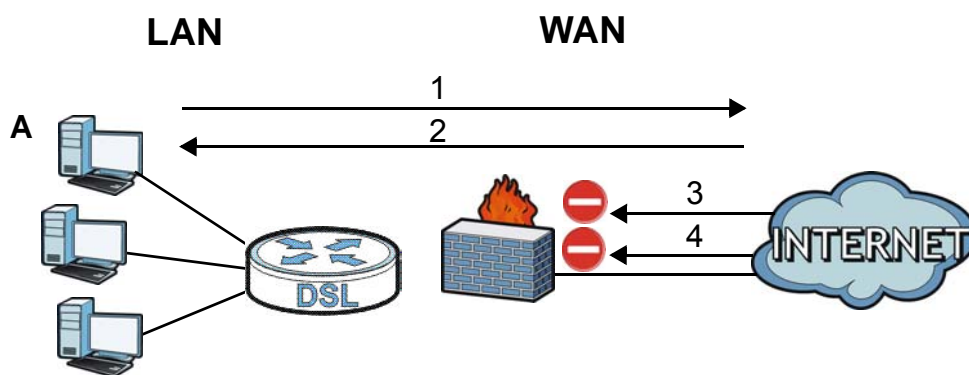

18.1.1 What You Can Do in this Chapter

- Use the **General** screen to configure the security level of the firewall on the Device ([Section 18.2 on page 208](#)).
- Use the **Protocol** screen to add or remove predefined Internet services and configure firewall rules ([Section 18.3 on page 209](#)).
- Use the **Access Control** screen to view and configure incoming/outgoing filtering rules ([Section 18.4 on page 212](#)).
- Use the **DoS** screen to activate protection against Denial of Service (DoS) attacks ([Section 18.5 on page 214](#)).

18.1.2 What You Need to Know

SYN Attack

A SYN attack floods a targeted system with a series of SYN packets. Each packet causes the targeted system to issue a SYN-ACK response. While the targeted system waits for the ACK that follows the SYN-ACK, it queues up all outstanding SYN-ACK responses on a backlog queue. SYN-ACKs are moved off the queue only when an ACK comes back or when an internal timer terminates the three-way handshake. Once the queue is full, the system will ignore all incoming SYN requests, making the system unavailable for legitimate users.

DoS

Denials of Service (DoS) attacks are aimed at devices and networks with a connection to the Internet. Their goal is not to steal information, but to disable a device or network so users no longer have access to network resources. The Device is pre-configured to automatically detect and thwart all known DoS attacks.

DDoS

A DDoS attack is one in which multiple compromised systems attack a single target, thereby causing denial of service for users of the targeted system.

LAND Attack

In a LAND attack, hackers flood SYN packets into the network with a spoofed source IP address of the target system. This makes it appear as if the host computer sent the packets to itself, making the system unavailable while the target system tries to respond to itself.

Ping of Death

Ping of Death uses a "ping" utility to create and send an IP packet that exceeds the maximum 65,536 bytes of data allowed by the IP specification. This may cause systems to crash, hang or reboot.

SPI

Stateful Packet Inspection (SPI) tracks each connection crossing the firewall and makes sure it is valid. Filtering decisions are based not only on rules but also context. For example, traffic from the WAN may only be allowed to cross the firewall in response to a request from the LAN.

18.2 The Firewall Screen

Use this screen to set the security level of the firewall on the Device. Firewall rules are grouped based on the direction of travel of packets to which they apply.

Click **Security** > **Firewall** to display the **General** screen.

Figure 113 Security > Firewall > General

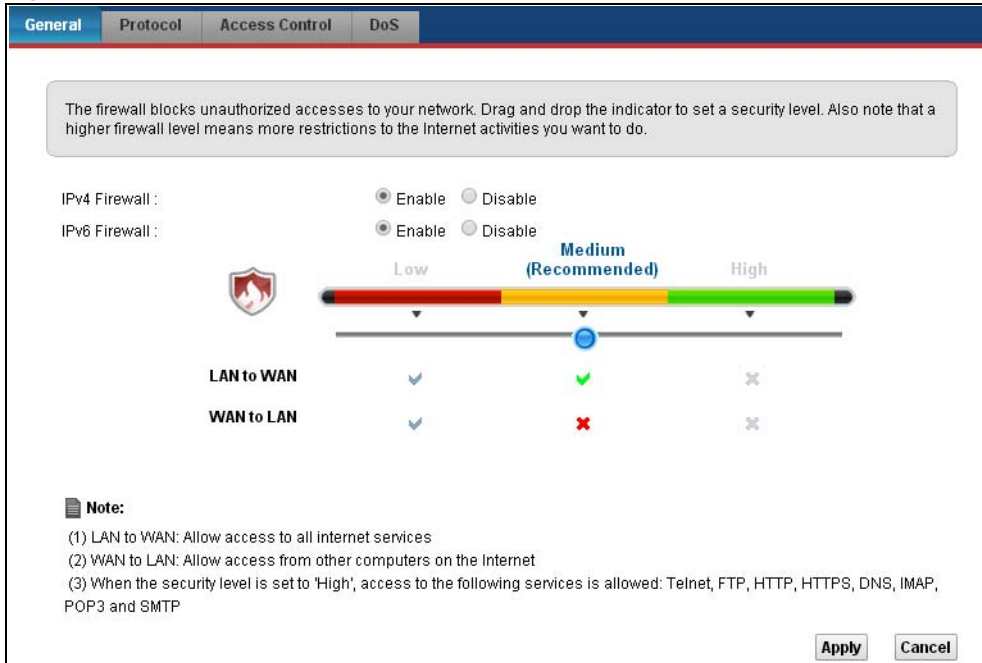

The following table describes the labels in this screen.

Table 84 Security > Firewall > General

LABEL	DESCRIPTION
Firewall	Select Enable to activate the firewall feature on the Device.
Easy	Select Easy to allow LAN to WAN and WAN to LAN packet directions.
Medium	Select Medium to allow LAN to WAN but deny WAN to LAN packet directions.
High	Select High to deny LAN to WAN and WAN to LAN packet directions.
Apply	Click Apply to save your changes.
Cancel	Click Cancel to restore your previously saved settings.

18.3 The Protocol Screen

You can configure customized services and port numbers in the **Protocol** screen. For a comprehensive list of port numbers and services, visit the IANA (Internet Assigned Number Authority) website. See [Appendix D on page 314](#) for some examples.

Click **Security > Firewall > Protocol** to display the following screen.

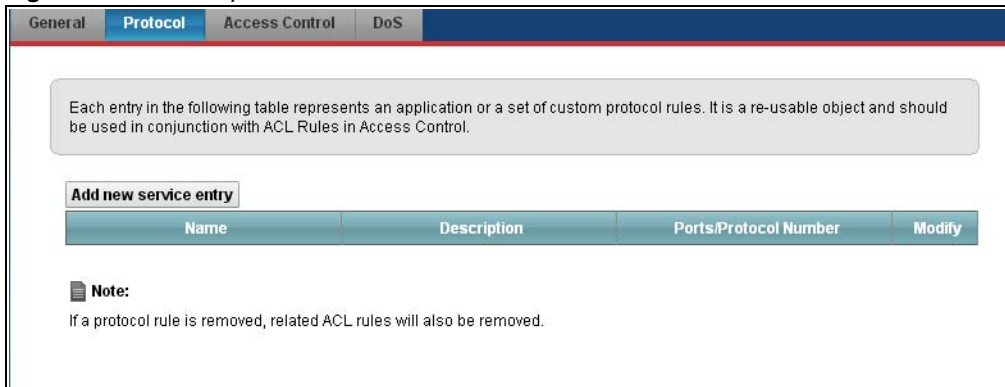
Figure 114 Security > Firewall > Protocol

The following table describes the labels in this screen.

Table 85 Security > Firewall > Protocol

LABEL	DESCRIPTION
Add new service entry	Click this to add a new service.
Name	This is the name of your customized service.
Description	This is the description of your customized service.
Ports/Protocol Number	This shows the IP protocol (TCP , UDP , ICMP , or TCP/UDP) and the port number or range of ports that defines your customized service. Other and the protocol number displays if the service uses another IP protocol.
Modify	Click the Edit icon to edit the entry. Click the Delete icon to remove this entry.

18.3.1 Add/Edit a Service

Use this screen to add a customized service rule that you can use in the firewall's ACL rule configuration. Click **Add new service entry** or the edit icon next to an existing service rule in the **Service** screen to display the following screen.

Figure 115 Service: Add/Edit

The screenshot shows a window titled "Add new service entry". At the top, there is a "Protocol:" label with a dropdown menu currently showing "Other". Below it is a "Protocol Number:" label with a text input field containing "0" and "(0-255)" to its right. An "Add" button is positioned to the right of the "Protocol Number" field. Below these fields is a section titled "Rule List" which contains a table with three columns: "Protocol", "Ports/Protocol Number", and "Delete". Underneath the table are two text input fields labeled "Service Name:" and "Service Description:". At the bottom right of the window are "Apply" and "Cancel" buttons.

The following table describes the labels in this screen.

Table 86 Service: Add/Edit

LABEL	DESCRIPTION
Protocol	Choose the IP protocol (TCP , UDP , ICMP , or Other) that defines your customized port from the drop-down list box. Select Other to be able to enter a protocol number.
Source/ Destination Port	These fields are displayed if you select TCP or UDP as the IP port. Select Single to specify one port only or Range to specify a span of ports that define your customized service. If you select Any , the service is applied to all ports. Type a single port number or the range of port numbers that define your customized service.
Protocol Number	This field is displayed if you select Other as the protocol. Enter the protocol number of your customized port.
Add	Click this to add the protocol to the Rule List below.
Rule List	
Protocol	This is the IP port (TCP , UDP , ICMP , or Other) that defines your customized port.
Ports/Protocol Number	For TCP , UDP , ICMP , or TCP/UDP protocol rules this shows the port number or range that defines the custom service. For other IP protocol rules this shows the protocol number.
Delete	Click the Delete icon to remove the rule.
Service Name	Enter a unique name (up to 32 printable English keyboard characters, including spaces) for your customized port.
Service Description	Enter a description for your customized port.
Apply	Click Apply to save your changes.
Cancel	Click Cancel to exit this screen without saving.

18.4 The Access Control Screen

Click **Security > Firewall > Access Control** to display the following screen. This screen displays a list of the configured incoming or outgoing filtering rules.

Figure 116 Security > Firewall > Access Control

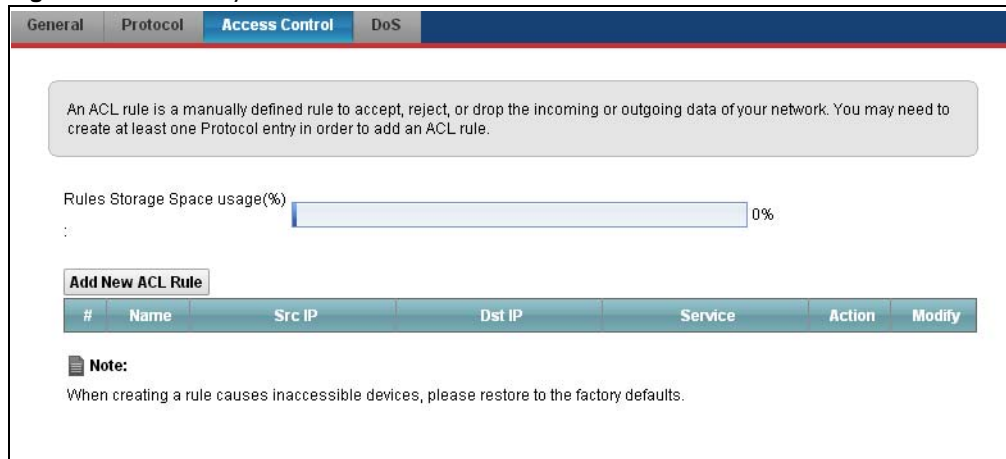

The following table describes the labels in this screen.

Table 87 Security > Firewall > Access Control

LABEL	DESCRIPTION
Add new ACL rule	Click this to go to add a filter rule for incoming or outgoing IP traffic.
#	This is the index number of the entry.
Name	This displays the name of the rule.
Src IP	This displays the source IP addresses to which this rule applies. Please note that a blank source address is equivalent to Any .
Dst IP	This displays the destination IP addresses to which this rule applies. Please note that a blank destination address is equivalent to Any .
Service	This displays the transport layer protocol that defines the service and the direction of traffic to which this rule applies.
Action	This field displays whether the rule silently discards packets (DROP), discards packets and sends a TCP reset packet or an ICMP destination-unreachable message to the sender (REJECT) or allows the passage of packets (ACCEPT).
Modify	Click the Edit icon to edit the rule. Click the Delete icon to delete an existing rule. Note that subsequent rules move up by one when you take this action. Click the Move To icon to change the order of the rule. Enter the number in the # field.

18.4.1 Add/Edit an ACL Rule

Click **Add new ACL rule** or the **Edit** icon next to an existing ACL rule in the **Access Control** screen. The following screen displays.

Figure 117 Access Control: Add/Edit

The screenshot shows a window titled "Add New Rule" with a close button (X) in the top right corner. The window contains the following fields and controls:

- Filter Name: Text input field
- Order: Dropdown menu with "1" selected
- Source IP Address: Dropdown menu with "Specific IP Address" selected
- Source IP Address: Text input field with "[prefix length]" label
- Select Destination Device: Dropdown menu with "Specific IP Address" selected
- Destination IP Address: Text input field with "[prefix length]" label
- IP Type: Dropdown menu with "IPv4" selected
- Select Service: Dropdown menu with "Specific Service" selected
- Protocol: Dropdown menu
- Custom Source Port: Text input field with "(port or port:port)" label
- Custom Destination Port: Text input field with "(port or port:port)" label
- Policy: Dropdown menu with "ACCEPT" selected
- Direction: Dropdown menu with "WAN to LAN" selected
- Enable Rate Limit: Check box (unchecked)
- Rate Limit: Text input field with "packet(s) per" label, a dropdown menu with "Minute" selected, and "(1-512)" label
- Scheduler Rules: Dropdown menu with "Add new rule" label

At the bottom right of the window are "Apply" and "Cancel" buttons.

The following table describes the labels in this screen.

Table 88 Access Control: Add/Edit

LABEL	DESCRIPTION
Filter Name	Enter a descriptive name of up to 16 alphanumeric characters, not including spaces, underscores, and dashes. You must enter the filter name to add an ACL rule. This field is read-only if you are editing the ACL rule.
Order	Select the order of the ACL rule.
Select Source Device	Select the source device to which the ACL rule applies. If you select Specific IP Address , enter the source IP address in the field below.
Source IP Address	Enter the source IP address.
Select Destination Device	Select the destination device to which the ACL rule applies. If you select Specific IP Address , enter the destination IP address in the field below.
Destination IP Address	Enter the destination IP address.
IP Type	Select whether your IP type is IPv4 or IPv6 .
Select Protocol	Select the transport layer protocol that defines your customized port from the drop-down list box. The specific protocol rule sets you add in the Security > Firewall > Service > Add screen display in this list. If you want to configure a customized protocol, select Specific Service .
Protocol	This field is displayed only when you select Specific Protocol in Select Protocol . Choose the IP port (TCP/UDP, TCP, UDP, ICMP, or ICMPv6) that defines your customized port from the drop-down list box.
Custom Source Port	This field is displayed only when you select Specific Protocol in Select Protocol . Enter a single port number or the range of port numbers of the source.

Table 88 Access Control: Add/Edit (continued)

LABEL	DESCRIPTION
Custom Destination Port	This field is displayed only when you select Specific Protocol in Select Protocol . Enter a single port number or the range of port numbers of the destination.
Policy	Use the drop-down list box to select whether to discard (DROP), deny and send an ICMP destination-unreachable message to the sender of (REJECT) or allow the passage of (ACCEPT) packets that match this rule.
Direction	Use the drop-down list box to select the direction of traffic to which this rule applies.
Enable Rate Limit	Select this check box to set a limit on the upstream/downstream transmission rate for the specified protocol. Specify how many packets per minute or second the transmission rate is.
Scheduler Rules	Select a schedule rule for this ACL rule form the drop-down list box. You can configure a new schedule rule by click Add New Rule . This will bring you to the Security > Scheduler Rules screen.
Apply	Click Apply to save your changes.
Cancel	Click Cancel to exit this screen without saving.

18.5 The DoS Screen

DoS (Denial of Service) attacks can flood your Internet connection with invalid packets and connection requests, using so much bandwidth and so many resources that Internet access becomes unavailable.

Use the **DoS** screen to activate protection against DoS attacks. Click **Security > Firewall > DoS** to display the following screen.

Figure 118 Security > Firewall > DoS

The following table describes the labels in this screen.

Table 89 Security > Firewall > DoS

LABEL	DESCRIPTION
DoS Protection Blocking	Select Enable to enable protection against DoS attacks.
Deny Ping Response	Select Enable to block ping request packets.

Table 89 Security > Firewall > DoS (continued)

LABEL	DESCRIPTION
Apply	Click Apply to save your changes.
Cancel	Click Cancel to exit this screen without saving.

MAC Filter

19.1 Overview

You can configure the Device to permit access to clients based on their MAC addresses in the **MAC Filter** screen. This applies to wired and wireless connections. Every Ethernet device has a unique MAC (Media Access Control) address. The MAC address is assigned at the factory and consists of six pairs of hexadecimal characters, for example, 00:A0:C5:00:00:02. You need to know the MAC addresses of the devices to configure this screen.

19.2 The MAC Filter Screen

Use this screen to allow wireless and LAN clients access to the Device. Click **Security > MAC Filter**. The screen appears as shown.

Figure 119 Security > MAC Filter

Enable MAC Filter and add the MAC addresses of the LAN clients in your home or office to the following table if you wish to allow only them to access your network. Sometimes, MAC Filter is considered a method to increase the security of your network.

MAC Address Filter : Enable Disable (settings are invalid when disabled)

MAC Restrict Mode : Allow Deny

Set	Allow	Host name	MAC Address
1	<input type="checkbox"/>	<input type="text"/>	<input type="text"/>
2	<input type="checkbox"/>	<input type="text"/>	<input type="text"/>
3	<input type="checkbox"/>	<input type="text"/>	<input type="text"/>
4	<input type="checkbox"/>	<input type="text"/>	<input type="text"/>
5	<input type="checkbox"/>	<input type="text"/>	<input type="text"/>
6	<input type="checkbox"/>	<input type="text"/>	<input type="text"/>
7	<input type="checkbox"/>	<input type="text"/>	<input type="text"/>
8	<input type="checkbox"/>	<input type="text"/>	<input type="text"/>
...			
30	<input type="checkbox"/>	<input type="text"/>	<input type="text"/>
31	<input type="checkbox"/>	<input type="text"/>	<input type="text"/>
32	<input type="checkbox"/>	<input type="text"/>	<input type="text"/>

Note:
Only devices listed here are granted or prohibit access to the network.

The following table describes the labels in this screen.

Table 90 Security > MAC Filter

LABEL	DESCRIPTION
MAC Address Filter	Select Enable to activate the MAC filter function.
MAC Restrict Mode	Select Allow to only permit the listed MAC addresses access to the Device. Select Deny to permit anyone access to the Device except the listed MAC addresses.
Set	This is the index number of the MAC address.
Allow	Select Allow to enable the MAC filter rule. . The rule will not be applied if Allow is not selected.
Host name	Enter the host name of the wireless or LAN clients that are allowed access to the Device.
MAC Address	Enter the MAC addresses of the wireless or LAN clients that are allowed access to the Device in these address fields. Enter the MAC addresses in a valid MAC address format, that is, six hexadecimal character pairs, for example, 12:34:56:78:9a:bc.
Apply	Click Apply to save your changes.
Cancel	Click Cancel to restore your previously saved settings.

Parental Control

20.1 Overview

Parental control allows you to block web sites with the specific URL. You can also define time periods and days during which the Device performs parental control on a specific user.

20.2 The Parental Control Screen

Use this screen to enable parental control, view the parental control rules and schedules.

Click **Security > Parental Control** to open the following screen.

Figure 120 Security > Parental Control

The following table describes the fields in this screen.

Table 91 Security > Parental Control

LABEL	DESCRIPTION
Parental Control	Select Enable to activate parental control.
Add new PCP	Click this if you want to configure a new Parental Control Profile (PCP).
#	This shows the index number of the rule.
Status	This indicates whether the rule is active or not. A yellow bulb signifies that this rule is active. A gray bulb signifies that this rule is not active.

Table 91 Security > Parental Control (continued)

LABEL	DESCRIPTION
PCP Name	This shows the name of the rule.
Home Network User (MAC)	This shows the MAC address of the LAN user's computer to which this rule applies.
Internet Access Schedule	This shows the day(s) and time on which parental control is enabled.
Network Service	This shows whether the network service is configured. If not, None will be shown.
Website Block	This shows whether the website block is configured. If not, None will be shown.
Modify	Click the Edit icon to go to the screen where you can edit the rule. Click the Delete icon to delete an existing rule.
Apply	Click Apply to save your changes.
Cancel	Click Cancel to restore your previously saved settings.

20.2.1 Add/Edit a Parental Control Profile

Click **Add new PCP** in the **Parental Control** screen to add a new rule or click the **Edit** icon next to an existing rule to edit it. Use this screen to configure a restricted access schedule and/or URL filtering settings to block the users on your network from accessing certain web sites.

Figure 121 Parental Control Rule: Add/Edit Rule

Add new PCP

General

Active

Parental Control Profile Name : MyPCP

Home Network User : Custom 12.34.56.78.9a.bc

Rule List

User MAC Address
12.34.56.78.9a.bc

Internet Access Schedule

Day : Everyday Monday Tuesday Wednesday Thursday
 Friday Saturday Sunday

Time (Start - End) : 18:30-24:00
 00:00-24:00
 08:30-24:00

No access Authorized access

Network Service

Network Service Settings : Block selected service(s)

Add New Service

#	Service Name	Protocol:Port	Modify

Site/URL Keyword

Block or Allow the Web Site : Block the web URLs

Add **Delete**

Apply Cancel

Figure 122 Parental Control Rule: Add/Edit Rule > Add Service

Add New Service

Service Name : UserDefined

Protocol : TCP

Port :
 (Example: 4091, 5091-6892)

OK Cancel

Figure 123 Parental Control Rule: Add/Edit Rule > Add Keyword

The following table describes the fields in this screen.

Table 92 Parental Control Rule: Add/Edit

LABEL	DESCRIPTION
General	
Active	Select the checkbox to activate this parental control rule.
Parental Control Profile Name	Enter a descriptive name for the rule.
Home Network User	Select the LAN user that you want to apply this rule to from the drop-down list box. If you select Custom , enter the LAN user's MAC address. If you select All , the rule applies to all LAN users.
Rule List	In Home Network User , select Custom , enter the LAN user's MAC address, then click the + sign to enter a computer MAC address for this PCP. Up to five are allowed. Click the - sign to remove one.
Internet Access Schedule	
Day	Select check boxes for the days that you want the Device to perform parental control.
Time	Drag the time bar to define the time that the LAN user is allowed access (Authorized access) or denied access (No access). Click the + sign above the time bar to add a new time bar. Up to three are allowed.
Authorized access	Select this to allow access for the times defined above.
No access	Select this to deny access for the times defined above.
Network Service	
Network Service Setting	If you select Block , the Device prohibits the users from viewing the Web sites with the URLs listed below. If you select Allow , the Device blocks access to all URLs except ones listed below.
Add new service	Click this to show a screen in which you can add a new service rule. You can configure the Service Name , Protocol , and Name of the new rule.
#	This shows the index number of the rule. Select the checkbox next to the rule to activate it.
Service Name	This shows the name of the rule.
Protocol:Port	This shows the protocol and the port of the rule.

Table 92 Parental Control Rule: Add/Edit (continued)

LABEL	DESCRIPTION
Modify	Click the Edit icon to go to the screen where you can edit the rule. Click the Delete icon to delete an existing rule.
Blocked Site/ URL Keyword	Click Add to show a screen to enter the URL of web site or URL keyword to which the Device blocks access. Click Delete to remove it.
Apply	Click this button to save your settings back to the Device.
Cancel	Click Cancel to restore your previously saved settings.

Scheduler Rule

21.1 Overview

You can define time periods and days during which the Device performs scheduled rules of certain features (such as Firewall Access Control) in the **Scheduler Rule** screen.

21.2 The Scheduler Rule Screen

Use this screen to view, add, or edit time schedule rules.

Click **Security > Scheduler Rule** to open the following screen.

Figure 124 Security > Scheduler Rule

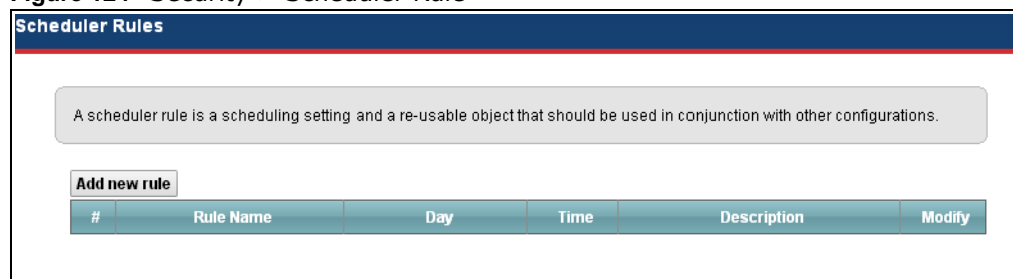

The following table describes the fields in this screen.

Table 93 Security > Scheduler Rule

LABEL	DESCRIPTION
Add new rule	Click this to create a new rule.
#	This is the index number of the entry.
Rule Name	This shows the name of the rule.
Day	This shows the day(s) on which this rule is enabled.
Time	This shows the period of time on which this rule is enabled.
Description	This shows the description of this rule.
Modify	Click the Edit icon to edit the schedule. Click the Delete icon to delete a scheduler rule. Note: You cannot delete a scheduler rule once it is applied to a certain feature.

21.2.1 Add/Edit a Schedule

Click the **Add** button in the **Scheduler Rule** screen or click the **Edit** icon next to a schedule rule to open the following screen. Use this screen to configure a restricted access schedule.

Figure 125 Scheduler Rule: Add/Edit

The following table describes the fields in this screen.

Table 94 Scheduler Rule: Add/Edit

LABEL	DESCRIPTION
Rule Name	Enter a name (up to 31 printable English keyboard characters, not including spaces) for this schedule.
Day	Select check boxes for the days that you want the Device to perform this scheduler rule.
Time if Day Range	Enter the time period of each day, in 24-hour format, during which the rule will be enforced.
Description	Enter a description for this scheduler rule.
Apply	Click Apply to save your changes.
Cancel	Click Cancel to exit this screen without saving.

Certificates

22.1 Overview

The Device can use certificates (also called digital IDs) to authenticate users. Certificates are based on public-private key pairs. A certificate contains the certificate owner's identity and public key. Certificates provide a way to exchange public keys for use in authentication.

22.1.1 What You Can Do in this Chapter

- The **Local Certificates** screen lets you generate certification requests and import the Device's CA-signed certificates ([Section 22.4 on page 228](#)).
- The **Trusted CA** screen lets you save the certificates of trusted CAs to the Device ([Section 22.4 on page 228](#)).

22.2 What You Need to Know

The following terms and concepts may help as you read through this chapter.

Certification Authority

A Certification Authority (CA) issues certificates and guarantees the identity of each certificate owner. There are commercial certification authorities like CyberTrust or VeriSign and government certification authorities. The certification authority uses its private key to sign certificates. Anyone can then use the certification authority's public key to verify the certificates. You can use the Device to generate certification requests that contain identifying information and public keys and then send the certification requests to a certification authority.

22.3 The Local Certificates Screen

Click **Security** > **Certificates** to open the **Local Certificates** screen. This is the Device's summary list of certificates and certification requests.

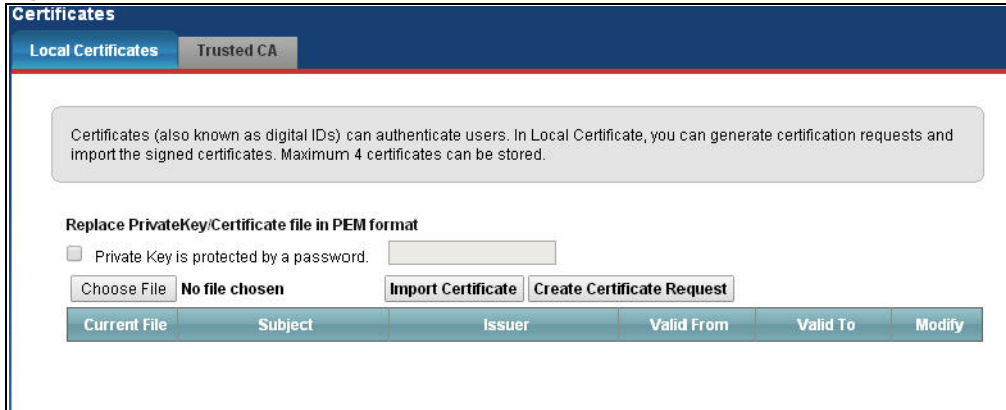
Figure 126 Security > Certificates > Local Certificates

The following table describes the labels in this screen.

Table 95 Security > Certificates > Local Certificates

LABEL	DESCRIPTION
Private Key is protected by a password	Select the checkbox and enter the private key into the text box to store it on the Device. The private key should not exceed 63 ASCII characters (not including spaces).
Browse...	Click this to find the certificate file you want to upload.
Import Certificate	Click this button to save the certificate that you have enrolled from a certification authority from your computer to the Device.
Create Certificate Request	Click this button to go to the screen where you can have the Device generate a certification request.
Current File	This field displays the name used to identify this certificate. It is recommended that you give each certificate a unique name.
Subject	This field displays identifying information about the certificate's owner, such as CN (Common Name), OU (Organizational Unit or department), O (Organization or company) and C (Country). It is recommended that each certificate have unique subject information.
Issuer	This field displays identifying information about the certificate's issuing certification authority, such as a common name, organizational unit or department, organization or company and country.
Valid From	This field displays the date that the certificate becomes applicable. The text displays in red and includes a Not Yet Valid! message if the certificate has not yet become applicable.
Valid To	This field displays the date that the certificate expires. The text displays in red and includes an Expiring! or Expired! message if the certificate is about to expire or has already expired.
Modify	Click the View icon to open a screen with an in-depth list of information about the certificate (or certification request). For a certification request, click Load Signed to import the signed certificate. Click the Remove icon to delete the certificate (or certification request). You cannot delete a certificate that one or more features is configured to use.

22.3.1 Create Certificate Request

Click **Security > Certificates > Local Certificates** and then **Create Certificate Request** to open the following screen. Use this screen to have the Device generate a certification request.

Figure 127 Create Certificate Request

The following table describes the labels in this screen.

Table 96 Create Certificate Request

LABEL	DESCRIPTION
Certificate Name	Type up to 63 ASCII characters (not including spaces) to identify this certificate.
Common Name	Select Auto to have the Device configure this field automatically. Or select Customize to enter it manually. Type the IP address (in dotted decimal notation), domain name or e-mail address in the field provided. The domain name or e-mail address can be up to 63 ASCII characters. The domain name or e-mail address is for identification purposes only and can be any string.
Organization Name	Type up to 63 characters to identify the company or group to which the certificate owner belongs. You may use any character, including spaces, but the Device drops trailing spaces.
State/Province Name	Type up to 32 characters to identify the state or province where the certificate owner is located. You may use any character, including spaces, but the Device drops trailing spaces.
Country/Region Name	Select a country to identify the nation where the certificate owner is located.
Apply	Click Apply to save your changes.
Cancel	Click Cancel to exit this screen without saving.

After you click **Apply**, the following screen displays to notify you that you need to get the certificate request signed by a Certificate Authority. If you already have, click **Load_Signed** to import the signed certificate into the Device. Otherwise click **Back** to return to the **Local Certificates** screen.

Figure 128 Certificate Request Created

22.3.2 Load Signed Certificate

After you create a certificate request and have it signed by a Certificate Authority, in the **Local Certificates** screen click the certificate request's **Load Signed** icon to import the signed certificate into the Device.

Note: You must remove any spaces from the certificate's filename before you can import it.

Figure 129 Load Signed Certificate

The following table describes the labels in this screen.

Table 97 Load Signed Certificate

LABEL	DESCRIPTION
Certificate Name	This is the name of the signed certificate.
Certificate	Copy and paste the signed certificate into the text box to store it on the Device.
Apply	Click Apply to save your changes.
Cancel	Click Cancel to exit this screen without saving.

22.4 The Trusted CA Screen

Click **Security > Certificates > Trusted CA** to open the following screen. This screen displays a summary list of certificates of the certification authorities that you have set the Device to accept as trusted. The Device accepts any valid certificate signed by a certification authority on this list as being trustworthy; thus you do not need to import any certificate that is signed by one of these certification authorities.

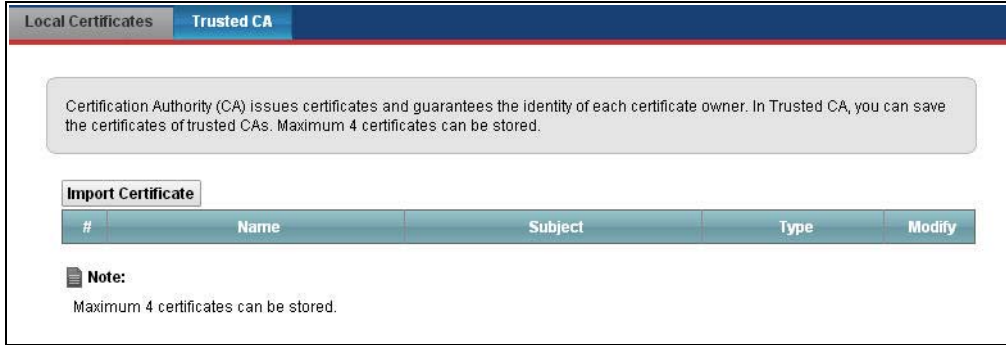
Figure 130 Security > Certificates > Trusted CA

The following table describes the fields in this screen.

Table 98 Security > Certificates > Trusted CA

LABEL	DESCRIPTION
Import Certificate	Click this button to open a screen where you can save the certificate of a certification authority that you trust to the Device.
#	This is the index number of the entry.
Name	This field displays the name used to identify this certificate.
Subject	This field displays information that identifies the owner of the certificate, such as Common Name (CN), OU (Organizational Unit or department), Organization (O), State (ST) and Country (C). It is recommended that each certificate have unique subject information.
Type	This field displays general information about the certificate. ca means that a Certification Authority signed the certificate.
Modify	Click the View icon to open a screen with an in-depth list of information about the certificate (or certification request). Click the Remove button to delete the certificate (or certification request). You cannot delete a certificate that one or more features is configured to use.

22.4.1 View Trusted CA Certificate

Click the **View** icon in the **Trusted CA** screen to open the following screen. Use this screen to view in-depth information about the certification authority's certificate.

Figure 131 Trusted CA: View

Name	certnew.cer
Type	ca
Subject	DC=com/DC=ZyxEL/CN=ZyxELCA
Certificate	<pre>-----BEGIN CERTIFICATE----- MIIEaTCCA1GgAwIBAgIQGKaoaDflmLIDGHjntb31jANBgkqhkiG9w0BAQUFADA+ MRMwEQYKCZImiZPyLQGQGRYDY29tMRUwEwYKCZImiZPyLQGQGRYFWhiYRUwxED AO BgNVBAMTB1p5WEVVMQ0EwHhcNMDcwMjA1MDMwMTI0WhcNMTcwMjA1MDMwOTQ5 WjA+ MRMwEQYKCZImiZPyLQGQGRYDY29tMRUwEwYKCZImiZPyLQGQGRYFWhiYRUwxED AO BgNVBAMTB1p5WEVVMQ0EwggEiMA0GCSqGSIb3DQEBAQUAA4IBDwAwggEKAoIBAQ DS</pre>
Back	

The following table describes the fields in this screen.

Table 99 Trusted CA: View

LABEL	DESCRIPTION
Name	This field displays the identifying name of this certificate.
Type	This field displays general information about the certificate. ca means that a Certification Authority signed the certificate.
Subject	This field displays information that identifies the owner of the certificate, such as Common Name (CN), Organizational Unit (OU), Organization (O) and Country (C).
Certificate	<p>This read-only text box displays the certificate in Privacy Enhanced Mail (PEM) format. PEM uses base 64 to convert the binary certificate into a printable form.</p> <p>You can copy and paste the certificate into an e-mail to send to friends or colleagues or you can copy and paste the certificate into a text editor and save the file on a management computer for later distribution (via floppy disk for example).</p>
Back	Click Back to return to the previous screen.

22.4.2 Import Trusted CA Certificate

Click the **Import Certificate** button in the **Trusted CA** screen to open the following screen. The Device trusts any valid certificate signed by any of the imported trusted CA certificates.

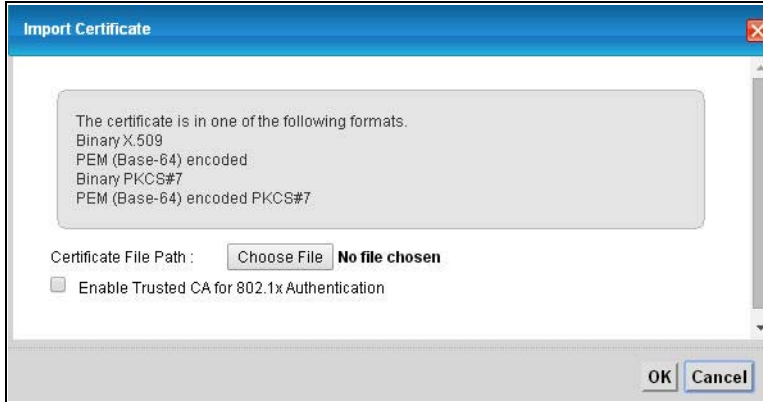
Figure 132 Trusted CA: Import Certificate

The following table describes the fields in this screen.

Table 100 Trusted CA: Import Certificate

LABEL	DESCRIPTION
Certificate File Path	Type in the location of the certificate you want to upload in this field or click Browse ... to find it.
Enable Trusted CA for 802.1x Authentication	If you select this checkbox, the trusted CA will be used for 802.1x authentication. The selected trusted CA will be displayed in the Network Setting > Broadband > 802.1x: Edit screen.
Certificate	Copy and paste the certificate into the text box to store it on the Device.
OK	Click OK to save your changes.
Cancel	Click Cancel to exit this screen without saving.

23.1 Overview

The web configurator allows you to choose which categories of events and/or alerts to have the Device log and then display the logs or have the Device send them to an administrator (as e-mail) or to a syslog server.

23.1.1 What You Can Do in this Chapter

- Use the **System Log** screen to see the system logs ([Section 23.2 on page 233](#)).
- Use the **Security Log** screen to see the security-related logs for the categories that you select ([Section 23.3 on page 234](#)).

23.1.2 What You Need To Know

The following terms and concepts may help as you read this chapter.

Alerts and Logs

An alert is a type of log that warrants more serious attention. They include system errors, attacks (access control) and attempted access to blocked web sites. Some categories such as **System Errors** consist of both logs and alerts. You may differentiate them by their color in the **View Log** screen. Alerts display in red and logs display in black.

Syslog Overview

The syslog protocol allows devices to send event notification messages across an IP network to syslog servers that collect the event messages. A syslog-enabled device can generate a syslog message and send it to a syslog server.

Syslog is defined in RFC 3164. The RFC defines the packet format, content and system log related information of syslog messages. Each syslog message has a facility and severity level. The syslog facility identifies a file in the syslog server. Refer to the documentation of your syslog program for details. The following table describes the syslog severity levels.

Table 101 Syslog Severity Levels

CODE	SEVERITY
0	Emergency: The system is unusable.
1	Alert: Action must be taken immediately.
2	Critical: The system condition is critical.
3	Error: There is an error condition on the system.
4	Warning: There is a warning condition on the system.

Table 101 Syslog Severity Levels

CODE	SEVERITY
5	Notice: There is a normal but significant condition on the system.
6	Informational: The syslog contains an informational message.
7	Debug: The message is intended for debug-level purposes.

23.2 The System Log Screen

Use the **System Log** screen to see the system logs. Click **System Monitor > Log** to open the **System Log** screen.

Figure 133 System Monitor > Log > System Log

The following table describes the fields in this screen.

Table 102 System Monitor > Log > System Log

LABEL	DESCRIPTION
Level	Select a severity level from the drop-down list box. This filters search results according to the severity level you have selected. When you select a severity, the Device searches through all logs of that severity or higher.
Category	Select the type of logs to display.
Clear Log	Click this to delete all the logs.
Refresh	Click this to renew the log screen.
Export Log	Click this to export the selected log(s).
Email Log Now	Click this to send the log file(s) to the E-mail address you specify in the Maintenance > Logs Setting screen.
System Log	
#	This field is a sequential value and is not associated with a specific entry.
Time	This field displays the time the log was recorded.
Facility	The log facility allows you to send logs to different files in the syslog server. Refer to the documentation of your syslog program for more details.
Level	This field displays the severity level of the logs that the device is to send to this syslog server.
Messages	This field states the reason for the log.

23.3 The Security Log Screen

Use the **Security Log** screen to see the security-related logs for the categories that you select. Click **System Monitor > Log > Security Log** to open the following screen.

Figure 134 System Monitor > Log > Security Log

The following table describes the fields in this screen.

Table 103 System Monitor > Log > Security Log

LABEL	DESCRIPTION
Level	Select a severity level from the drop-down list box. This filters search results according to the severity level you have selected. When you select a severity, the Device searches through all logs of that severity or higher.
Category	Select the type of logs to display.
Clear Log	Click this to delete all the logs.
Refresh	Click this to renew the log screen.
Export Log	Click this to export the selected log(s).
Email Log Now	Click this to send the log file(s) to the E-mail address you specify in the Maintenance > Logs Setting screen.
#	This field is a sequential value and is not associated with a specific entry.
Time	This field displays the time the log was recorded.
Facility	The log facility allows you to send logs to different files in the syslog server. Refer to the documentation of your syslog program for more details.
Level	This field displays the severity level of the logs that the device is to send to this syslog server.
Messages	This field states the reason for the log.

Traffic Status

24.1 Overview

Use the **Traffic Status** screens to look at network traffic status and statistics of the WAN, LAN interfaces and NAT.

24.1.1 What You Can Do in this Chapter

- Use the **WAN** screen to view the WAN traffic statistics (Section 24.2 on page 235).
- Use the **LAN** screen to view the LAN traffic statistics (Section 24.3 on page 236).
- Use the **NAT** screen to view the NAT status of the Device's client(s) (Section 24.4 on page 237)

24.2 The WAN Status Screen

Click **System Monitor > Traffic Status** to open the **WAN** screen. The figure in this screen shows the number of bytes received and sent on the Device.

Figure 135 System Monitor > Traffic Status > WAN

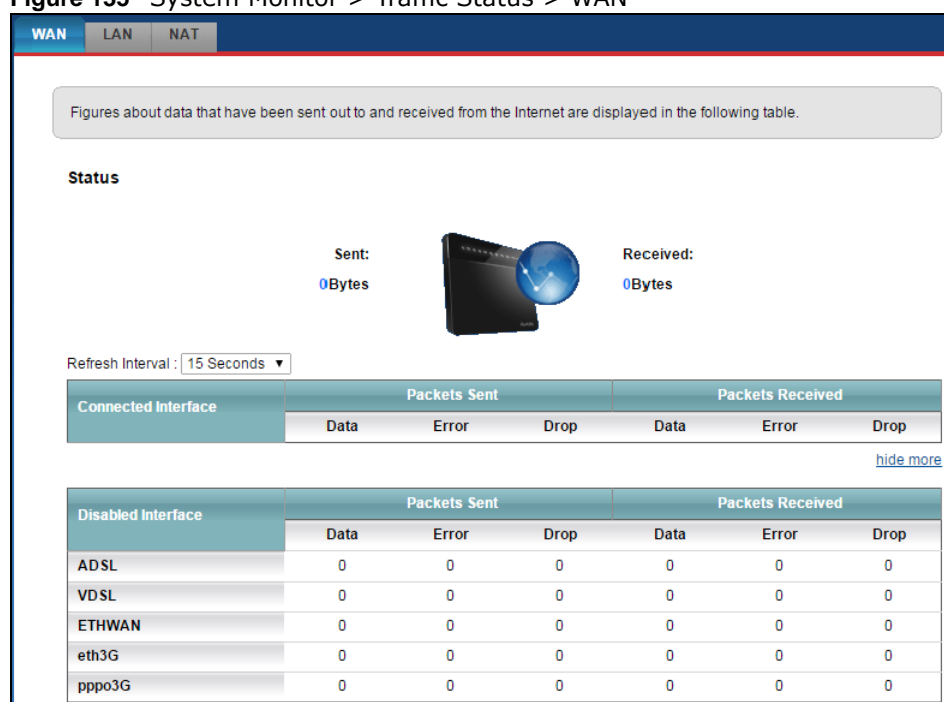

The following table describes the fields in this screen.

Table 104 System Monitor > Traffic Status > WAN

LABEL	DESCRIPTION
Connected Interface	This shows the name of the WAN interface that is currently connected.
Packets Sent	
Data	This indicates the number of transmitted packets on this interface.
Error	This indicates the number of frames with errors transmitted on this interface.
Drop	This indicates the number of outgoing packets dropped on this interface.
Packets Received	
Data	This indicates the number of received packets on this interface.
Error	This indicates the number of frames with errors received on this interface.
Drop	This indicates the number of received packets dropped on this interface.
more...hide more	Click more... to show more information. Click hide more to hide them.
Disabled Interface	This shows the name of the WAN interface that is currently disconnected.
Packets Sent	
Data	This indicates the number of transmitted packets on this interface.
Error	This indicates the number of frames with errors transmitted on this interface.
Drop	This indicates the number of outgoing packets dropped on this interface.
Packets Received	
Data	This indicates the number of received packets on this interface.
Error	This indicates the number of frames with errors received on this interface.
Drop	This indicates the number of received packets dropped on this interface.

24.3 The LAN Status Screen

Click **System Monitor > Traffic Status > LAN** to open the following screen. The figure in this screen shows the interface that is currently connected on the Device.

Figure 136 System Monitor > Traffic Status > LAN

Figures about data that have been sent to and received from each LAN port (including wireless) are displayed in the following table.

Refresh Interval: 15 Seconds ▼

Interface	LAN1	LAN2	LAN3	LAN4	2.4G WLAN	5G WLAN
Bytes Sent	0	0	21,930,612	0	0	0

[hide more](#)

Interface	LAN1	LAN2	LAN3	LAN4	2.4G WLAN	5G WLAN
Sent (Packet)	Data	0	0	119430	0	0
	Error	0	0	0	0	0
	Drop	0	0	0	0	0
Received (Packet)	Data	0	0	196159	0	0
	Error	0	0	0	0	0
	Drop	0	0	0	0	0

The following table describes the fields in this screen.

Table 105 System Monitor > Traffic Status > LAN

LABEL	DESCRIPTION
Refresh Interval	Select how often you want the Device to update this screen.
Interface	This shows the LAN or WLAN interface.
Bytes Sent	This indicates the number of bytes transmitted on this interface.
Bytes Received	This indicates the number of bytes received on this interface.
more...hide more	Click more... to show more information. Click hide more to hide them.
Interface	This shows the LAN or WLAN interfaces.
Sent (Packets)	
Data	This indicates the number of transmitted packets on this interface.
Error	This indicates the number of frames with errors transmitted on this interface.
Drop	This indicates the number of outgoing packets dropped on this interface.
Received (Packets)	
Data	This indicates the number of received packets on this interface.
Error	This indicates the number of frames with errors received on this interface.
Drop	This indicates the number of received packets dropped on this interface.

24.4 The NAT Status Screen

Click **System Monitor > Traffic Status > NAT** to open the following screen. The figure in this screen shows the NAT session statistics for hosts currently connected on the Device.

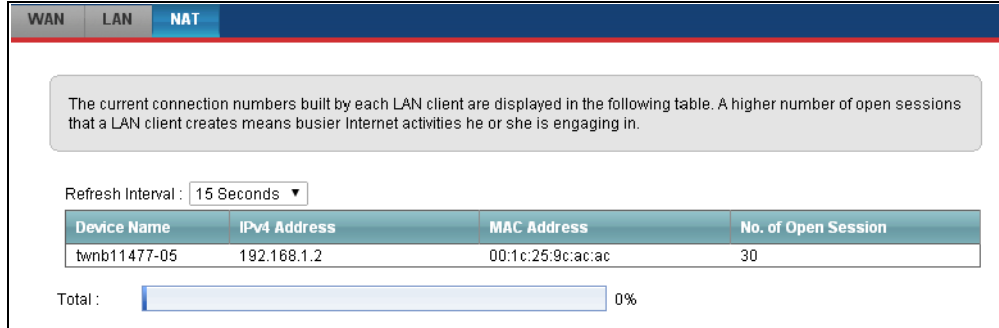
Figure 137 System Monitor > Traffic Status > NAT

The following table describes the fields in this screen.

Table 106 System Monitor > Traffic Status > NAT

LABEL	DESCRIPTION
Refresh Interval	Select how often you want the Device to update this screen.
Device Name	This displays the name of the connected host.
IP Address	This displays the IP address of the connected host.
MAC Address	This displays the MAC address of the connected host.
No. of Open Session	This displays the number of NAT sessions currently opened for the connected host.
Total	This displays what percentage of NAT sessions the Device can support is currently being used by all connected hosts.

ARP Table

25.1 Overview

Address Resolution Protocol (ARP) is a protocol for mapping an Internet Protocol address (IP address) to a physical machine address, also known as a Media Access Control or MAC address, on the local area network.

An IP (version 4) address is 32 bits long. In an Ethernet LAN, MAC addresses are 48 bits long. The ARP Table maintains an association between each MAC address and its corresponding IP address.

25.1.1 How ARP Works

When an incoming packet destined for a host device on a local area network arrives at the device, the device's ARP program looks in the ARP Table and, if it finds the address, sends it to the device.

If no entry is found for the IP address, ARP broadcasts the request to all the devices on the LAN. The device fills in its own MAC and IP address in the sender address fields, and puts the known IP address of the target in the target IP address field. In addition, the device puts all ones in the target MAC field (FF.FF.FF.FF.FF.FF is the Ethernet broadcast address). The replying device (which is either the IP address of the device being sought or the router that knows the way) replaces the broadcast address with the target's MAC address, swaps the sender and target pairs, and unicasts the answer directly back to the requesting machine. ARP updates the ARP Table for future reference and then sends the packet to the MAC address that replied.

25.2 ARP Table Screen

Use the ARP table to view IP-to-MAC address mapping(s). To open this screen, click **System Monitor > ARP Table**.

Figure 138 System Monitor > ARP Table

ARP table			
<p>ARP Table displays the IPv4 and MAC address of each DHCP connection. Neighbour Table displays the IPv6 address and MAC address of each Neighbour.</p>			
IPv4 ARP Table			
#	IPv4 Address	MAC Address	Device
1	172.23.30.217	74:27:ea:2b:fa:aa	WAN
2	192.168.1.2	00:1c:25:9c:ac:ac	LAN
3	172.23.30.254	00:04:80:9b:78:00	WAN
IPv6 Neighbour Table			
#	IPv6 Address	MAC Address	Device

The following table describes the labels in this screen.

Table 107 System Monitor > ARP Table

LABEL	DESCRIPTION
#	This is the ARP table entry number.
IPv4/IPv6 Address	This is the learned IPv4 or IPv6 IP address of a device connected to a port.
MAC Address	This is the MAC address of the device with the listed IP address.
Device	This is the type of interface used by the device. You can click on the device type to go to its configuration screen.

Routing Table

26.1 Overview

Routing is based on the destination address only and the Device takes the shortest path to forward a packet.

26.2 The Routing Table Screen

Click **System Monitor > Routing Table** to open the following screen.

Figure 139 System Monitor > Routing Table

Destination: The destination network or destination host.
 Gateway: The gateway address or ""(IPv4)"/:(IPv6) if none set.
 Subnet Mask (IPv4): The netmask for the destination net, '255.255.255.255' for a host destination and '0.0.0.0' for the default route.
 Flags: U - up, ! - reject, G - gateway, C - cache, H - host, R - reinstate, D - dynamic (redirect), M - modified (redirect).
 Metric: The distance to the target (usually counted in hops).
 Interface: Interface to which packets for this route will be sent.

IPv4 Routing Table

Destination	Gateway	Subnet Mask	Flag	Metric	Interface
172.23.30.0	*	255.255.255.0	U	0	eth3.1
192.168.1.0	*	255.255.255.0	U	0	br0
default	172.23.30.254	0.0.0.0	UG	0	eth3.1

IPv6 Routing Table

Destination	Gateway	Flag	Metric	Interface
fe80::/64	::	U	256	br0
fd00::/8	::	U	256	br0

The following table describes the labels in this screen.

Table 108 System Monitor > Routing Table

LABEL	DESCRIPTION
IPv4/IPv6 Routing Table	
Destination	This indicates the destination IPv4 address or IPv6 address and prefix of this route.
Gateway	This indicates the IPv4 address or IPv6 address of the gateway that helps forward this route's traffic.
Subnet Mask	This indicates the destination subnet mask of the IPv4 route.

Table 108 System Monitor > Routing Table (continued)

LABEL	DESCRIPTION
Flag	<p>This indicates the route status.</p> <p>U-Up: The route is up.</p> <p>!-Reject: The route is blocked and will force a route lookup to fail.</p> <p>G-Gateway: The route uses a gateway to forward traffic.</p> <p>H-Host: The target of the route is a host.</p> <p>R-Reinstate: The route is reinstated for dynamic routing.</p> <p>D-Dynamic (redirect): The route is dynamically installed by a routing daemon or redirect.</p> <p>M-Modified (redirect): The route is modified from a routing daemon or redirect.</p>
Metric	<p>The metric represents the "cost of transmission". A router determines the best route for transmission by choosing a path with the lowest "cost". The smaller the number, the lower the "cost".</p>
Service	<p>This indicates the name of the service used to forward the route.</p>
Interface	<p>This indicates the name of the interface through which the route is forwarded.</p> <p>brx indicates a LAN interface where x can be 0~3 to represent LAN1 to LAN4 respectively.</p> <p>ptm0 indicates a WAN interface using IPoE or in bridge mode.</p> <p>ppp0 indicates a WAN interface using PPPoE.</p>

IGMP/MLD Status

27.1 Overview

Use the **IGMP Status** screens to look at IGMP/MLD group status and traffic statistics.

27.2 The IGMP/MLD Group Status Screen

Use this screen to look at the current list of multicast groups the Device has joined and which ports have joined it. To open this screen, click **System Monitor > IGMP/MLD Group Status**.

Figure 140 System Monitor > IGMP/MLD Group Status

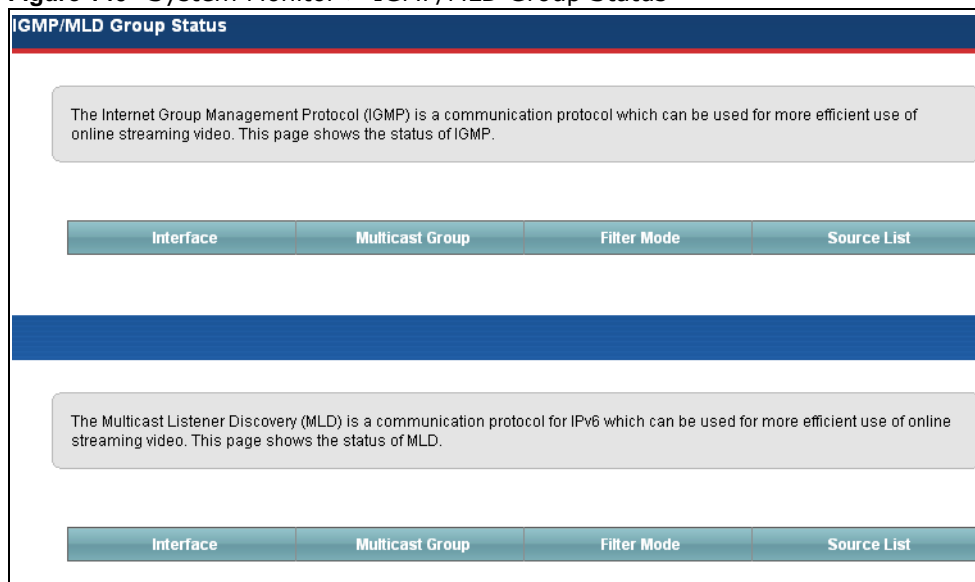

The following table describes the labels in this screen.

Table 109 System Monitor > IGMP/MLD Group Status

LABEL	DESCRIPTION
Interface	This field displays the name of an interface on the Device that belongs to an IGMP or MLD multicast group.
Multicast Group	This field displays the name of the IGMP or MLD multicast group to which the interface belongs.

Table 109 System Monitor > IGMP/MLD Group Status (continued)

LABEL	DESCRIPTION
Filter Mode	INCLUDE means that only the IP addresses in the Source List get to receive the multicast group's traffic. EXCLUDE means that the IP addresses in the Source List are not allowed to receive the multicast group's traffic but other IP addresses can.
Source List	This is the list of IP addresses that are allowed or not allowed to receive the multicast group's traffic depending on the filter mode.

xDSL Statistics

28.1 The xDSL Statistics Screen

Use this screen to view detailed DSL statistics. Click **System Monitor > xDSL Statistics** to open the following screen.

Figure 141 System Monitor > xDSL Statistics

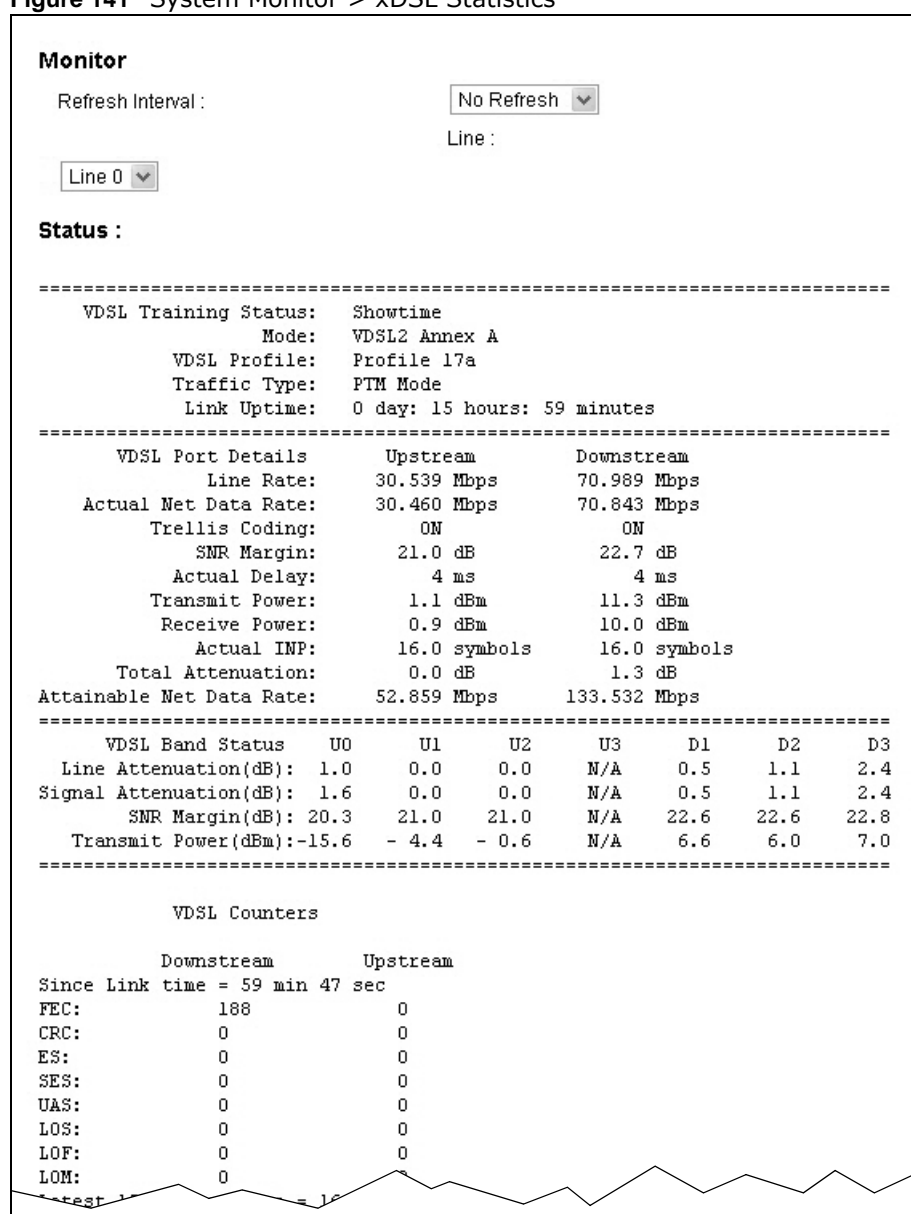

VDSL Counters		
	Downstream	Upstream
Since Link time = 59 min 47 sec		
FEC:	188	0
CRC:	0	0
ES:	0	0
SES:	0	0
UAS:	0	0
LOS:	0	0
LOF:	0	0
LOM:	0	0
Latest 15 minutes time = 16 sec		
FEC:	0	0
CRC:	0	0
ES:	0	0
SES:	0	0
UAS:	0	0
LOS:	0	0
LOF:	0	0
LOM:	0	0
Previous 15 minutes time = 15 min 0 sec		
FEC:	0	0
CRC:	0	0
ES:	0	0
SES:	0	0
UAS:	0	0
LOS:	0	0
LOF:	0	0
LOM:	0	0
Latest 1 day time = 16 hours 16 sec		
FEC:	188	0
CRC:	0	0
ES:	0	0
SES:	0	0
UAS:	28	28
LOS:	0	0
LOF:	0	0
LOM:	0	0
Previous 1 day time = 0 sec		
FEC:	0	0
CRC:	0	0
ES:	0	0
SES:	0	0
UAS:	0	0
LOS:	0	0
LOF:	0	0
LOM:	0	0
Previous 15 minutes time = 15 min 0 sec		
FEC:	0	0
CRC:	0	0
ES:	0	0
SES:	0	0
UAS:	0	0
LOS:	0	0
LOF:	0	0
LOM:	0	0
Latest 1 day time = 16 hours 16 sec		
FEC:	188	0
CRC:	0	0
ES:	0	0
SES:	0	0
UAS:	28	28
LOS:	0	0
LOF:	0	0
LOM:	0	0
Previous 1 day time = 0 sec		

The following table describes the labels in this screen.

Table 110 Status > xDSL Statistics

LABEL	DESCRIPTION
Refresh Interval	Select the time interval for refreshing statistics.
Line	Select which DSL line's statistics you want to display.
xDSL Training Status	This displays the current state of setting up the DSL connection.
Mode	This displays the ITU standard used for this connection.
Traffic Type	This displays the type of traffic the DSL port is sending and receiving. Inactive displays if the DSL port is not currently sending or receiving traffic.
Link Uptime	This displays how long the port has been running (or connected) since the last time it was started.
xDSL Port Details	
Upstream	These are the statistics for the traffic direction going out from the port to the service provider.
Downstream	These are the statistics for the traffic direction coming into the port from the service provider.
Line Rate	These are the data transfer rates at which the port is sending and receiving data.
Actual Net Data Rate	These are the rates at which the port is sending and receiving the payload data without transport layer protocol headers and traffic.
Trellis Coding	This displays whether or not the port is using Trellis coding for traffic it is sending and receiving. Trellis coding helps to reduce the noise in ADSL transmissions. Trellis may reduce throughput but it makes the connection more stable.
SNR Margin	This is the upstream and downstream Signal-to-Noise Ratio margin (in dB). A DMT sub-carrier's SNR is the ratio between the received signal power and the received noise power. The signal-to-noise ratio margin is the maximum that the received noise power could increase with the system still being able to meet its transmission targets.
Actual Delay	This is the upstream and downstream interleave delay. It is the wait (in milliseconds) that determines the size of a single block of data to be interleaved (assembled) and then transmitted. Interleave delay is used when transmission error correction (Reed- Solomon) is necessary due to a less than ideal telephone line. The bigger the delay, the bigger the data block size, allowing better error correction to be performed.
Transmit Power	This is the upstream and downstream far end actual aggregate transmit power (in dBm). Upstream is how much power the port is using to transmit to the service provider. Downstream is how much power the service provider is using to transmit to the port.
Receive Power	Upstream is how much power the service provider is receiving from the port. Downstream is how much power the port is receiving from the service provider.
Actual INP	Sudden spikes in the line's level of external noise (impulse noise) can cause errors and result in lost packets. This could especially impact the quality of multimedia traffic such as voice or video. Impulse noise protection (INP) provides a buffer to allow for correction of errors caused by error correction to deal with this. The number of DMT (Discrete Multi-Tone) symbols shows the level of impulse noise protection for the upstream and downstream traffic. A higher symbol value provides higher error correction capability, but it causes overhead and higher delay which may increase error rates in received multimedia data.
Total Attenuation	This is the upstream and downstream line attenuation, measured in decibels (dB). This attenuation is the difference between the power transmitted at the near-end and the power received at the far-end. Attenuation is affected by the channel characteristics (wire gauge, quality, condition and length of the physical line).
Attainable Net Data Rate	These are the highest theoretically possible transfer rates at which the port could send and receive payload data without transport layer protocol headers and traffic.
xDSL Counters	

Table 110 Status > xDSL Statistics (continued)

LABEL	DESCRIPTION
Downstream	These are the statistics for the traffic direction coming into the port from the service provider.
Upstream	These are the statistics for the traffic direction going out from the port to the service provider.
FEC	This is the number of Far End Corrected blocks.
CRC	This is the number of Cyclic Redundancy Checks.
ES	This is the number of Errored Seconds meaning the number of seconds containing at least one errored block or at least one defect.
SES	This is the number of Severely Errored Seconds meaning the number of seconds containing 30% or more errored blocks or at least one defect. This is a subset of ES.
UAS	This is the number of UnAvailable Seconds.
LOS	This is the number of Loss Of Signal seconds.
LOF	This is the number of Loss Of Frame seconds.
LOM	This is the number of Loss of Margin seconds.

3G Statistics

29.1 Overview

Use the **3G Statistics** screens to look at 3G Internet connection status.

29.2 The 3G Statistics Screen

To open this screen, click **System Monitor > 3G Statistics**. The 3G status is available on this screen only when you insert a compatible 3G dongle in a USB port on the Device.

Figure 142 System Monitor > 3G Statistics

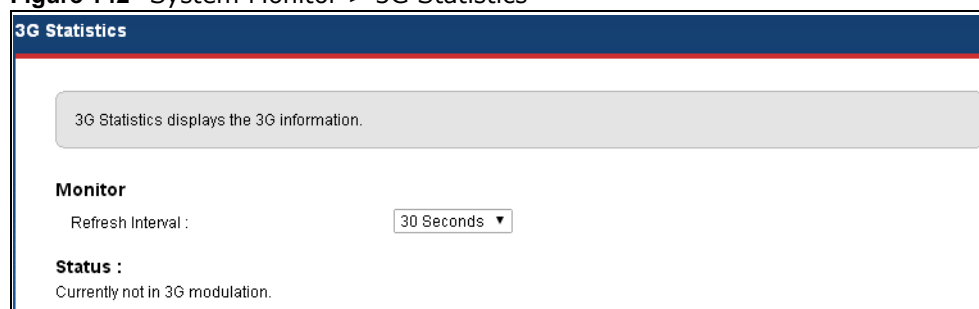

The following table describes the labels in this screen.

Table 111 System Monitor > 3G Statistics

LABEL	DESCRIPTION
Refresh Interval	Select how often you want the Device to update this screen. Select No Refresh to stop refreshing.
3G Status	This field displays the status of the 3G Internet connection. This field can display: GSM - Global System for Mobile Communications, 2G GPRS - General Packet Radio Service, 2.5G EDGE - Enhanced Data rates for GSM Evolution, 2.75G WCDMA - Wideband Code Division Multiple Access, 3G HSDPA - High-Speed Downlink Packet Access, 3.5G HSUPA - High-Speed Uplink Packet Access, 3.75G HSPA - HSDPA+HSUPA, 3.75G
Service Provider	This field displays the name of the service provider.
Signal Strength	This field displays the strength of the signal in dBm.

Table 111 System Monitor > 3G Statistics (continued)

LABEL	DESCRIPTION
Connection Uptime	This field displays the time the connection has been up.
3G Card Manufacturer	This field displays the manufacturer of the 3G card.
3G Card Model	This field displays the model name of the 3G card.
3G Card F/W Version	This field displays the firmware version of the 3G card.
SIM Card IMSI	The International Mobile Subscriber Identity or IMSI is a unique identification number associated with all cellular networks. This number is provisioned in the SIM card.

User Account

30.1 Overview

A user account is the In the **Users Account** screen, you can change the password of the “admin” user account that you used to log in the Device.

30.2 The User Account Screen

Click **Maintenance > User Account** to open the following screen.

Figure 143 Maintenance > User Account

The screenshot shows the 'User Account' screen. At the top, there is a header 'User Account' and a description: 'User Account lets you create or manage the user accounts on the device.' Below this is a table with the following data:

#	User Name	Retry Times	Idle Timeout	Lock Period	Group	Modify
1	admin	0	60 min(s)	15 min(s)	Administrator	
2	zyuser	0	10 min(s)	15 min(s)	User	

Below the table is a 'Note' section: 'Click Edit for more user account configurations.' At the bottom right, there are 'Apply' and 'Cancel' buttons.

The following table describes the labels in this screen.

Table 112 Maintenance > User Account

LABEL	DESCRIPTION
#	This is the index number
User Name	This field displays the name of the account used to log into the Device web configurator.
Retry Times	This field displays the number of times consecutive wrong passwords can be entered for this account. 0 means there is no limit.
Idle Timeout	This field displays the the length of inactive time before the Device will automatically log the user out of the web configurator.
Lock Period	This field displays the length of time a user must wait before attempting to log in again after a number if consecutive wrong passwords have been entered as defined in Retry Times .
Group	This field displays whether this user has Administrator or User privileges.
Modify	Click the Edit icon to configure the entry. Click the Delete icon to remove the entry.

Table 112 Maintenance > User Account (continued) (continued)

LABEL	DESCRIPTION
Apply	Click Apply to save your changes.
Cancel	Click Cancel to restore your previously saved settings.

30.2.1 The User Account Add/Edit Screen

Click Add new user or the Edit icon of an existing account in the **Maintenance > User Account** to open the following screen.

Figure 144 Maintenance > User Account >Add/Edit

The following table describes the labels in this screen.

Table 113 Maintenance > User Account

LABEL	DESCRIPTION
User Name	Enter a new name for the This field displays the name of an existing account.
Old Password	Type the default password or the existing password used to access the Device web configurator.
New Password	Type your new system password (up to 256 characters). Note that as you type a password, the screen displays a (*) for each character you type. After you change the password, use the new password to access the Device.
Verify Password	Type the new password again for confirmation.
Retry Times	Enter the number of times consecutive wrong passwords can be entered for this account. 0 means there is no limit.
Idle Timeout	Enter the length of inactive time before the Device will automatically log the user out of the web configurator.
Lock Period	Enter the length of time a user must wait before attempting to log in again after a number if consecutive wrong passwords have been entered as defined in Retry Times .
Group	Specify whether this user will have Administrator or User privileges.
Apply	Click Apply to save your changes.
Cancel	Click Cancel to restore your previously saved settings.

Remote Management

31.1 Overview

Remote management controls through which interface(s), which services can access the Device.

Note: The Device is managed using the Web Configurator.

31.2 The Remote MGMT Screen

Use this screen to configure through which interface(s), which services can access the Device. You can also specify the port numbers the services must use to connect to the Device. Click **Maintenance > Remote MGMT** to open the following screen.

Figure 145 Maintenance > Remote MGMT

Remote MGMT enables various approaches to access this device remotely from a WAN and/or LAN connection.

Service Control

WAN Interface used for services: Any_WAN Multi_WAN

ADSL VDSL ETHWAN eth3G pppo3G

HTTP	LAN/WLAN	WAN	Port
HTTPS	<input checked="" type="checkbox"/> Enable	<input type="checkbox"/> Enable	443
HTTP	<input checked="" type="checkbox"/> Enable	<input type="checkbox"/> Enable	80
TELNET	<input checked="" type="checkbox"/> Enable	<input type="checkbox"/> Enable	23
FTP	<input checked="" type="checkbox"/> Enable	<input type="checkbox"/> Enable	21
SSH	<input checked="" type="checkbox"/> Enable	<input type="checkbox"/> Enable	22

Certificate

HTTPS Certificate:

Apply Cancel

The following table describes the fields in this screen.

Table 114 Maintenance > Remote MGMT

LABEL	DESCRIPTION
WAN Interface used for services	Select Any WAN to have the Device automatically activate the remote management service when any WAN connection is up. Select Multi WAN and then select one or more WAN connections to have the Device activate the remote management service when the selected WAN connections are up.
HTTP	This is the service you may use to access the Device.
LAN/WLAN	Select the Enable check box for the corresponding services that you want to allow access to the Device from the LAN/WLAN.
WAN	Select the Enable check box for the corresponding services that you want to allow access to the Device from all WAN connections.
Port	You may change the server port number for a service if needed, however you must use the same port number in order to use that service for remote management.
Certificate	
HTTPS Certificate	Select a certificate the HTTPS server (the Device) uses to authenticate itself to the HTTPS client. You must have certificates already configured in the Certificates screen.
Apply	Click Apply to save your changes back to the Device.
Cancel	Click Cancel to restore your previously saved settings.

TR-069 Client

32.1 Overview

This chapter explains how to configure the Device's TR-069 auto-configuration settings.

32.2 The TR-069 Client Screen

TR-069 defines how Customer Premise Equipment (CPE), for example your Device, can be managed over the WAN by an Auto Configuration Server (ACS). TR-069 is based on sending Remote Procedure Calls (RPCs) between an ACS and a client device. RPCs are sent in Extensible Markup Language (XML) format over HTTP or HTTPS.

An administrator can use an ACS to remotely set up the Device, modify settings, perform firmware upgrades as well as monitor and diagnose the Device. You have to enable the device to be managed by the ACS and specify the ACS IP address or domain name and username and password.

Click **Maintenance > TR-069 Client** to open the following screen. Use this screen to configure your Device to be managed by an ACS.

Figure 146 Maintenance > TR-069 Client

TR069 is a remote management tool on this device. The operator can upgrade firmware, modify settings, and diagnose problems remotely when TR069 is enabled.

Inform: Enable Disable

Inform Interval:

ACS URL: (URL or IPv4 address / global IPv6 address)

ACS User Name:

ACS Password:

WAN Interface used by TR-069 client: Any_WAN Multi_WAN

ADSL VDSL ETHWAN eth3G pppo3G

Display SOAP messages on serial console: Enable Disable

Connection Request Authentication

Connection Request User Name:

Connection Request Password:

Connection Request URL:

Local certificate used by TR-069 client:

Apply Cancel

The following table describes the fields in this screen.

Table 115 Maintenance > TR-069 Client

LABEL	DESCRIPTION
Inform	Select Enable for the Device to send periodic inform via TR-069 on the WAN. Otherwise, select Disable .
Inform Interval	Enter the time interval (in seconds) at which the Device sends information to the auto-configuration server.
ACS URL	Enter the URL or IP address of the auto-configuration server.
ACS User Name	Enter the TR-069 user name for authentication with the auto-configuration server.
ACS Password	Enter the TR-069 password for authentication with the auto-configuration server.
WAN Interface used by TR-069 client	<p>Select a WAN interface through which the TR-069 traffic passes.</p> <p>If you select Any_WAN, the Device automatically passes the TR-069 traffic when any WAN connection is up.</p> <p>If you select Multi_WAN, you also need to select two or more pre-configured WAN interfaces. The Device automatically passes the TR-069 traffic when one of the selected WAN connections is up.</p>
Display SOAP messages on serial console	Select Enable to show the SOAP messages on the console.
Connection Request Authentication	Select this option to enable authentication when there is a connection request from the ACS.
Connection Request User Name	<p>Enter the connection request user name.</p> <p>When the ACS makes a connection request to the Device, this user name is used to authenticate the ACS.</p>
Connection Request Password	<p>Enter the connection request password.</p> <p>When the ACS makes a connection request to the Device, this password is used to authenticate the ACS.</p>
Connection Request URL	<p>This shows the connection request URL.</p> <p>The ACS can use this URL to make a connection request to the Device.</p>
Local certificate used by TR-069 client	You can choose a local certificate used by TR-069 client. The local certificate should be imported in the Security > Certificates > Local Certificates screen.
Apply	Click Apply to save your changes.
Cancel	Click Cancel to exit this screen without saving.

33.1 Overview

This chapter explains how to configure the Device's TR-064 auto-configuration settings.

33.2 The TR-064 Screen

TR-064 is a LAN-Side DSL CPE Configuration protocol defined by the DSL Forum. TR-064 is built on top of UPnP. It allows the users to use a TR-064 compliant CPE management application on their computers from the LAN to discover the CPE and configure user-specific parameters, such as the username and password.

Click **Maintenance > TR-064** to open the following screen.

Figure 147 Maintenance > TR-064

The following table describes the fields in this screen.

Table 116 Maintenance > TR-064

LABEL	DESCRIPTION
State	Select Enable to activate management via TR-064 on the LAN.
Apply	Click Apply to save your changes.
Cancel	Click Cancel to exit this screen without saving.

34.1 Overview

This chapter explains how to configure the SNMP settings on the Device.

34.2 The SNMP Screen

Simple Network Management Protocol is a protocol used for exchanging management information between network devices. Your Device supports SNMP agent functionality, which allows a manager station to manage and monitor the Device through the network. The Device supports SNMP version one (SNMPv1) and version two (SNMPv2c). The next figure illustrates an SNMP management operation.

Figure 148 SNMP Management Model

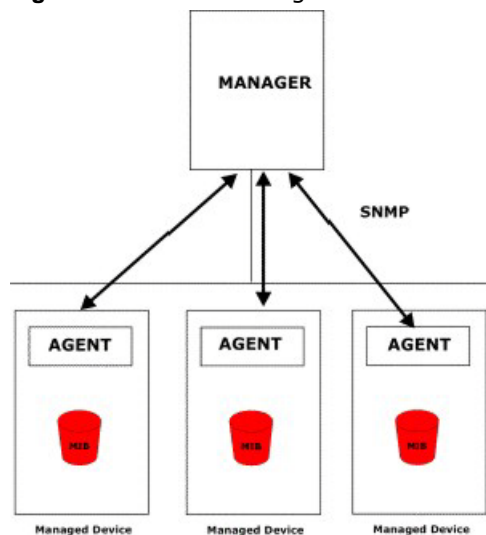

An SNMP managed network consists of two main types of component: agents and a manager.

An agent is a management software module that resides in a managed device (the Device). An agent translates the local management information from the managed device into a form compatible with SNMP. The manager is the console through which network administrators perform network management functions. It executes applications that control and monitor managed devices.

The managed devices contain object variables/managed objects that define each piece of information to be collected about a device. Examples of variables include such as number of packets received, node port status etc. A Management Information Base (MIB) is a collection of

managed objects. SNMP allows a manager and agents to communicate for the purpose of accessing these objects.

SNMP itself is a simple request/response protocol based on the manager/agent model. The manager issues a request and the agent returns responses using the following protocol operations:

- **Get** - Allows the manager to retrieve an object variable from the agent.
- **GetNext** - Allows the manager to retrieve the next object variable from a table or list within an agent. In SNMPv1, when a manager wants to retrieve all elements of a table from an agent, it initiates a Get operation, followed by a series of GetNext operations.
- **Set** - Allows the manager to set values for object variables within an agent.
- **Trap** - Used by the agent to inform the manager of some events.

Click **Maintenance > SNMP** to open the following screen. Use this screen to configure the Device SNMP settings.

Figure 149 Maintenance > SNMP

The following table describes the fields in this screen.

Table 117 Maintenance > SNMP

LABEL	DESCRIPTION
SNMP Agent	Select Enable to let the Device act as an SNMP agent, which allows a manager station to manage and monitor the Device through the network. Select Disable to turn this feature off.
Get Community	Enter the Get Community , which is the password for the incoming Get and GetNext requests from the management station.
Set Community	Enter the Set community , which is the password for incoming Set requests from the management station.
System Name	Enter the SNMP system name.
System Location	Enter the SNMP system location.
System Contact	Enter the SNMP system contact.
Trap Destination	Type the IP address of the station to send your SNMP traps to.
Apply	Click this to save your changes back to the Device.
Cancel	Click this to restore your previously saved settings.

Time Settings

35.1 Overview

This chapter shows you how to configure system related settings, such as system time, password, name, the domain name and the inactivity timeout interval.

35.2 The Time Screen

To change your Device's time and date, click **Maintenance > Time**. The screen appears as shown. Use this screen to configure the Device's time based on your local time zone.

Figure 150 Maintenance > Time

The following table describes the fields in this screen.

Table 118 Maintenance > Time

LABEL	DESCRIPTION
Current Date/Time	
Current Time	This field displays the time of your Device. Each time you reload this page, the Device synchronizes the time with the time server.

Table 118 Maintenance > Time (continued)

LABEL	DESCRIPTION
Current Date	This field displays the date of your Device. Each time you reload this page, the Device synchronizes the date with the time server.
NTP Time Server	
First ~ Fifth NTP time server	Select an NTP time server from the drop-down list box. Otherwise, select Other and enter the IP address or URL (up to 29 extended ASCII characters in length) of your time server. Select None if you don't want to configure the time server. Check with your ISP/network administrator if you are unsure of this information.
Time Zone	
Time zone offset	Choose the time zone of your location. This will set the time difference between your time zone and Greenwich Mean Time (GMT).
Daylight Saving	Daylight Saving Time is a period from late spring to early fall when many countries set their clocks ahead of normal local time by one hour to give more daytime light in the evening.
State	Select Enable if you use Daylight Saving Time.
Start rule:	Configure the day and time when Daylight Saving Time starts if you enabled Daylight Saving. You can select a specific date in a particular month or a specific day of a specific week in a particular month. The Time field uses the 24 hour format. Here are a couple of examples: Daylight Saving Time starts in most parts of the United States on the second Sunday of March. Each time zone in the United States starts using Daylight Saving Time at 2 A.M. local time. So in the United States, set the day to Second, Sunday , the month to March and the time to 2 in the Hour field. Daylight Saving Time starts in the European Union on the last Sunday of March. All of the time zones in the European Union start using Daylight Saving Time at the same moment (1 A.M. GMT or UTC). So in the European Union you would set the day to Last, Sunday and the month to March . The time you select in the o'clock field depends on your time zone. In Germany for instance, you would select 2 in the Hour field because Germany's time zone is one hour ahead of GMT or UTC (GMT+1).
End rule	Configure the day and time when Daylight Saving Time ends if you enabled Daylight Saving. You can select a specific date in a particular month or a specific day of a specific week in a particular month. The Time field uses the 24 hour format. Here are a couple of examples: Daylight Saving Time ends in the United States on the first Sunday of November. Each time zone in the United States stops using Daylight Saving Time at 2 A.M. local time. So in the United States you would set the day to First, Sunday , the month to November and the time to 2 in the Hour field. Daylight Saving Time ends in the European Union on the last Sunday of October. All of the time zones in the European Union stop using Daylight Saving Time at the same moment (1 A.M. GMT or UTC). So in the European Union you would set the day to Last, Sunday , and the month to October . The time you select in the o'clock field depends on your time zone. In Germany for instance, you would select 2 in the Hour field because Germany's time zone is one hour ahead of GMT or UTC (GMT+1).
Apply	Click Apply to save your changes.
Cancel	Click Cancel to exit this screen without saving.

E-mail Notification

36.1 Overview

A mail server is an application or a computer that runs such an application to receive, forward and deliver e-mail messages.

To have the Device send reports, logs or notifications via e-mail, you must specify an e-mail server and the e-mail addresses of the sender and receiver.

36.2 The Email Notification Screen

Click **Maintenance > Email Notification** to open the **Email Notification** screen. Use this screen to view, remove and add mail server information on the Device.

Figure 151 Maintenance > Email Notification

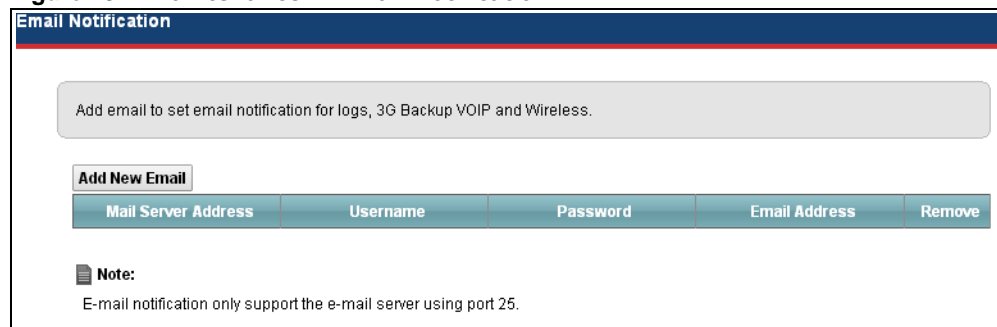

The following table describes the labels in this screen.

Table 119 Maintenance > Email Notification

LABEL	DESCRIPTION
Add New Email	Click this button to create a new entry.
Mail Server Address	This field displays the server name or the IP address of the mail server.
Username	This field displays the user name of the sender's mail account.
Password	This field displays the password of the sender's mail account.
Email Address	This field displays the e-mail address that you want to be in the from/sender line of the e-mail that the Device sends.
Delete	Click this button to delete the selected entry(ies).

36.2.1 Email Notification Edit

Click the **Add** button in the **Email Notification** screen. Use this screen to configure the required information for sending e-mail via a mail server.

Figure 152 Email Notification > Add

The screenshot shows a window titled "Email Notification" with a close button in the top right corner. Below the title bar, the text "Email Notification Configuration" is displayed. There are four input fields arranged vertically, each with a label to its left: "Mail Server Address:" followed by a text box and the text "(SMTP Server NAME or IP)" to its right; "Authentication Username:" followed by a text box; "Authentication Password:" followed by a text box; and "Account Email Address:" followed by a text box. At the bottom right of the window, there are two buttons: "Apply" and "Cancel".

The following table describes the labels in this screen.

Table 120 Email Notification > Add

LABEL	DESCRIPTION
Mail Server Address	Enter the server name or the IP address of the mail server for the e-mail address specified in the Account Email Address field. If this field is left blank, reports, logs or notifications will not be sent via e-mail.
Authentication Username	Enter the user name (up to 32 characters). This is usually the user name of a mail account you specified in the Account Email Address field.
Authentication Password	Enter the password associated with the user name above.
Account Email Address	Enter the e-mail address that you want to be in the from/sender line of the e-mail notification that the Device sends. If you activate SSL/TLS authentication, the e-mail address must be able to be authenticated by the mail server as well.
Apply	Click this button to save your changes and return to the previous screen.
Cancel	Click this button to begin configuring this screen afresh.

Log Setting

37.1 Overview

You can configure where the Device sends logs and which logs and/or immediate alerts the Device records in the **Logs Setting** screen.

37.2 The Log Settings Screen

To change your Device's log settings, click **Maintenance > Logs Setting**. The screen appears as shown.

Figure 153 Maintenance > Logs Setting

Log Setting

Log Setting defines which types of logs and which log levels you want to record. If you have a LAN client on your network that is running a syslog utility, you can also save the log files there by enabling Syslog Logging and enter the IP address of that LAN client.

Syslog Setting

Syslog Logging : Enable Disable (settings are invalid when disabled)

Mode: (Server NAME or IPv4/IPv6 Address)

Syslog Server: (Server NAME or IPv4/IPv6 Address)

UDP Port: (Server Port)

E-mail Log Settings

Mail Server:

System Log Mail Subject:

Security Log Mail Subject:

Send Log to: (E-Mail Address)

Send Alarm to: (E-Mail Address)

Alarm Interval: Second

Allowed Capacity Before email Notification: %

Clear log after sending mail: Enable Disable (settings are invalid when disabled)

Active Log and Alert

<p>System Log</p> <p><input checked="" type="checkbox"/> System</p> <p><input checked="" type="checkbox"/> DHCP client</p> <p><input checked="" type="checkbox"/> PPPoE</p> <p><input type="checkbox"/> Wireless</p> <p><input checked="" type="checkbox"/> DHCP Server</p> <p><input type="checkbox"/> UPnP</p> <p><input type="checkbox"/> NAT</p> <p><input type="checkbox"/> Static Route</p> <p><input type="checkbox"/> DDNS</p> <p><input type="checkbox"/> IGMP</p> <p><input type="checkbox"/> Qos</p> <p><input type="checkbox"/> TR-069</p> <p><input type="checkbox"/> NTP</p> <p><input type="checkbox"/> XDSL</p> <p><input type="checkbox"/> Internet</p> <p><input type="checkbox"/> VoIP</p>	<p>Security log</p> <p><input type="checkbox"/> Firewall</p> <p><input type="checkbox"/> MAC Filter</p> <p><input type="checkbox"/> Forward Web Sites</p> <p><input type="checkbox"/> Blocked Web Sites</p> <p><input type="checkbox"/> Attack</p> <p><input type="checkbox"/> Certificate</p> <p><input type="checkbox"/> IPSec</p> <p><input checked="" type="checkbox"/> Account</p>	<p>Send immediate alert</p> <p><input type="checkbox"/> Attacks</p> <p><input type="checkbox"/> Blocked Web Sites</p>
--	--	--

The following table describes the fields in this screen.

Table 121 Maintenance > Logs Setting

LABEL	DESCRIPTION
Syslog Setting	
Syslog Logging	The Device sends a log to an external syslog server. Select Enable to enable syslog logging.
Mode	Select the syslog destination from the drop-down list box. If you select Remote , the log(s) will be sent to a remote syslog server. If you select Local File , the log(s) will be saved in a local file. If you want to send the log(s) to a remote syslog server and save it in a local file, select Local File and Remote .
Syslog Server	Enter the server name or IP address of the syslog server that will log the selected categories of logs.
UDP Port	Enter the port number used by the syslog server.
E-mail Log Settings	
Mail Server	Enter the server name or the IP address of the mail server for the e-mail addresses specified below. If this field is left blank, logs and alert messages will not be sent via E-mail.
System Log Mail Subject	Type a title that you want to be in the subject line of the system log e-mail message that the Device sends.
Security Log Mail Subject	Type a title that you want to be in the subject line of the security log e-mail message that the Device sends.
Send Log to	The Device sends logs to the e-mail address specified in this field. If this field is left blank, the Device does not send logs via E-mail.
Send Alarm to	Alerts are real-time notifications that are sent as soon as an event, such as a DoS attack, system error, or forbidden web access attempt occurs. Enter the E-mail address where the alert messages will be sent. Alerts include system errors, attacks and attempted access to blocked web sites. If this field is left blank, alert messages will not be sent via E-mail.
Alarm Interval	Specify how often the alarm should be updated.
Allowed Capacity Before Email	Set what percent of the Device's log storage space can be filled before the Device sends a log e-mail.
Clear log after sending mail	Select this to delete all the logs after the Device sends an E-mail of the logs.
Active Log and Alert	
System Log	Select the categories of system logs that you want to record.
Security Log	Select the categories of security logs that you want to record.
Send immediate alert	Select log categories for which you want the Device to send E-mail alerts immediately.
Apply	Click Apply to save your changes.
Cancel	Click Cancel to restore your previously saved settings.

37.2.1 Example E-mail Log

An "End of Log" message displays for each mail in which a complete log has been sent. The following is an example of a log sent by e-mail.

- You may edit the subject title.
- The date format here is Day-Month-Year.
- The date format here is Month-Day-Year. The time format is Hour-Minute-Second.

- "End of Log" message shows that a complete log has been sent.

Figure 154 E-mail Log Example

```

Subject:
    Firewall Alert From
Date:
    Fri, 07 Apr 2000 10:05:42
From:
    user@zyxel.com
To:
    user@zyxel.com
1|Apr 7 00|From:192.168.1.1      To:192.168.1.255  |default policy  |forward
  | 09:54:03|UDP      src port:00520 dest port:00520  |<1,00>         |
2|Apr 7 00|From:192.168.1.131   To:192.168.1.255  |default policy  |forward
  | 09:54:17|UDP      src port:00520 dest port:00520  |<1,00>         |
3|Apr 7 00|From:192.168.1.6     To:10.10.10.10   |match           |forward
  | 09:54:19|UDP      src port:03516 dest port:00053  |<1,01>         |
.....{snip}.....
.....{snip}.....
126|Apr 7 00|From:192.168.1.1     To:192.168.1.255  |match           |forward
  | 10:05:00|UDP      src port:00520 dest port:00520  |<1,02>         |
127|Apr 7 00|From:192.168.1.131   To:192.168.1.255  |match           |forward
  | 10:05:17|UDP      src port:00520 dest port:00520  |<1,02>         |
128|Apr 7 00|From:192.168.1.1     To:192.168.1.255  |match           |forward
  | 10:05:30|UDP      src port:00520 dest port:00520  |<1,02>         |

End of Firewall Log

```

Firmware Upgrade

38.1 Overview

This chapter explains how to upload new firmware to your Device. You can download new firmware releases from your nearest ZyXEL FTP site (or www.zyxel.com) to use to upgrade your device's performance.

Only use firmware for your device's specific model. Refer to the label on the bottom of your Device.

38.2 The Firmware Screen

Click **Maintenance > Firmware Upgrade** to open the following screen. The upload process uses HTTP (Hypertext Transfer Protocol) and may take up to two minutes. After a successful upload, the system will reboot.

Do NOT turn off the Device while firmware upload is in progress!

Figure 155 Maintenance > Firmware Upgrade

The screenshot shows a web interface titled "Firmware Upgrade". At the top, there is a blue header bar with the text "Firmware Upgrade". Below the header, a grey box contains the following text: "Firmware and WWAN package Upgrade is where you can update the device with newly released features by upgrading the latest firmware and WWAN Package. You can download the latest firmware and WWAN Package file from the manufacturer website of this device." Below this, there are two sections: "Upgrade Firmware" and "Upgrade 3G Package". Each section displays the current version (V1.00(AAJZ.6)C1 for firmware and 1.11 for 3G package), a "File Path" input field with a "Browse..." button, and an "Upload" button.

The following table describes the labels in this screen. After you see the firmware updating screen, wait two minutes before logging into the Device again.

Table 122 Maintenance > Firmware Upgrade

LABEL	DESCRIPTION
Upgrade Firmware	
Current Firmware Version	This is the present Firmware version and the date created.
File Path	Type in the location of the file you want to upload in this field or click Browse ... to find it.
Browse...	Click this to find the .bin file you want to upload. Remember that you must decompress compressed (.zip) files before you can upload them.
Upload	Click this to begin the upload process. This process may take up to two minutes.
Upgrade 3G Package	
Current 3G Package Version	This is the present 3G Package version and the date created.
File Path	Type in the location of the file you want to upload in this field or click Browse ... to find it.
Browse...	Click this to find the .bin file you want to upload. Remember that you must decompress compressed (.zip) files before you can upload them.
Upload	Click this to begin the upload process. This process may take up to two minutes.

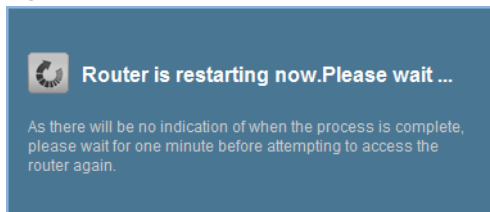
Figure 156 Firmware Uploading

The Device automatically restarts in this time causing a temporary network disconnect. In some operating systems, you may see the following icon on your desktop.

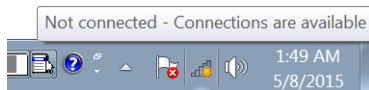
Figure 157 Network Temporarily Disconnected

After two minutes, log in again and check your new firmware version in the **Status** screen.

If the upload was not successful, the following screen will appear. Click **OK** to go back to the **Firmware Upgrade** screen.

Figure 158 Error Message

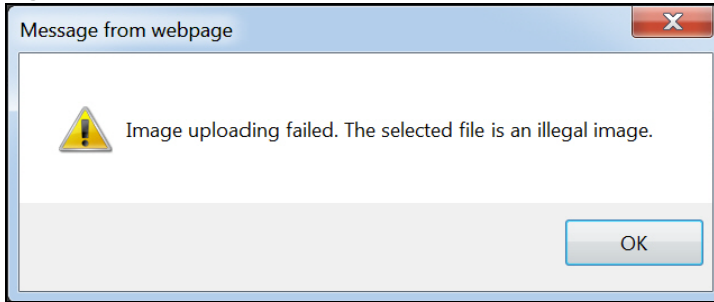

Configuration

39.1 Overview

The **Configuration** screen allows you to backup and restore device configurations. You can also reset your device settings back to the factory default.

39.2 The Configuration Screen

Click **Maintenance > Configuration**. Information related to factory defaults, backup configuration, and restoring configuration appears in this screen, as shown next.

Figure 159 Maintenance > Configuration

The screenshot shows the Configuration screen with a blue header. Below the header is a grey box with instructions: "In Configuration you can save the current device settings in a backup file in your computer, or recover the system by restoring the backup file. You can also reset the device back to factory default." Below this are three sections: "Backup Configuration" with a "Backup" button; "Restore Configuration" with a "File Path" field, a "Choose File" button, "No file chosen" text, and an "Upload" button; and "Back to Factory Defaults" with instructions and a "Reset" button.

Backup Configuration

Backup Configuration allows you to back up (save) the Device's current configuration to a file on your computer. Once your Device is configured and functioning properly, it is highly recommended that you back up your configuration file before making configuration changes. The backup configuration file will be useful in case you need to return to your previous settings.

Click **Backup** to save the Device's current configuration to your computer.

Restore Configuration

Restore Configuration allows you to upload a new or previously saved configuration file from your computer to your Device.

Table 123 Restore Configuration

LABEL	DESCRIPTION
File Path	Type in the location of the file you want to upload in this field or click Browse ... to find it.
Browse...	Click this to find the file you want to upload. Remember that you must decompress compressed (.ZIP) files before you can upload them.
Upload	Click this to begin the upload process.

Do not turn off the Device while configuration file upload is in progress.

After the Device configuration has been restored successfully, the login screen appears. Login again to restart the Device.

The Device automatically restarts in this time causing a temporary network disconnect. In some operating systems, you may see the following icon on your desktop.

Figure 160 Network Temporarily Disconnected

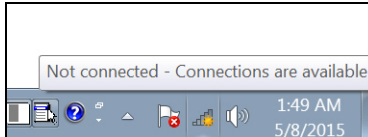

If you uploaded the default configuration file you may need to change the IP address of your computer to be in the same subnet as that of the default device IP address (192.168.1.1).

If the upload was not successful, the following screen will appear. Click **OK** to go back to the **Configuration** screen.

Figure 161 Configuration Upload Error

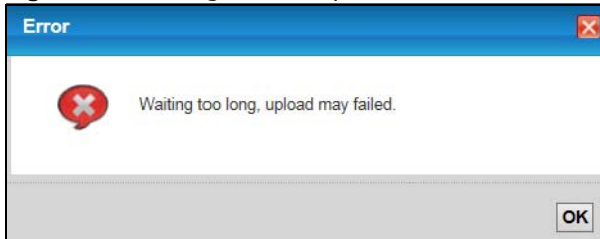

Reset to Factory Defaults

Click the **Reset** button to clear all user-entered configuration information and return the Device to its factory defaults. The following warning screen appears.

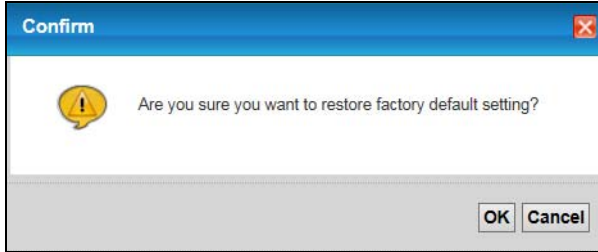
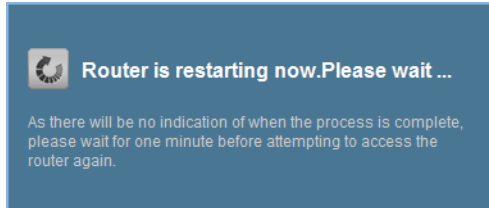
Figure 162 Reset Warning Message**Figure 163** Reset In Process Message

You can also press the **RESET** button on the rear panel to reset the factory defaults of your Device. Refer to [Section 1.6 on page 21](#) for more information on the **RESET** button.

39.3 The Reboot Screen

System restart allows you to reboot the Device remotely without turning the power off. You may need to do this if the Device hangs, for example.

Click **Maintenance > Reboot**. Click **Reboot** to have the Device reboot. This does not affect the Device's configuration.

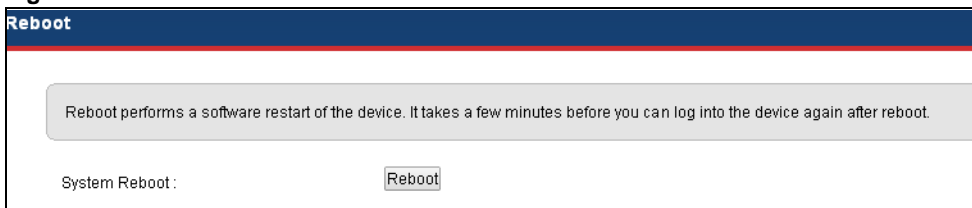
Figure 164 Maintenance > Reboot

40.1 Overview

The **Diagnostic** screens display information to help you identify problems with the Device.

The route between a CO VDSL switch and one of its CPE may go through switches owned by independent organizations. A connectivity fault point generally takes time to discover and impacts subscriber's network access. In order to eliminate the management and maintenance efforts, IEEE 802.1ag is a Connectivity Fault Management (CFM) specification which allows network administrators to identify and manage connection faults. Through discovery and verification of the path, CFM can detect, analyze and isolate connectivity faults in bridged LANs.

40.1.1 What You Can Do in this Chapter

- The **Ping & TraceRoute & NsLookup** screen lets you ping an IP address or trace the route packets take to a host ([Section 40.3 on page 274](#)).
- The **802.1ag** screen lets you perform CFM actions ([Section 40.5 on page 275](#)).
- The **OAM Ping** screen lets you send an ATM OAM (Operation, Administration and Maintenance) packet to verify the connectivity of a specific PVC. ([Section 40.5 on page 275](#)).

40.2 What You Need to Know

The following terms and concepts may help as you read through this chapter.

How CFM Works

A Maintenance Association (MA) defines a VLAN and associated Maintenance End Point (MEP) ports on the device under a Maintenance Domain (MD) level. An MEP port has the ability to send Connectivity Check Messages (CCMs) and get other MEP ports information from neighbor devices' CCMs within an MA.

CFM provides two tests to discover connectivity faults.

- Loopback test - checks if the MEP port receives its Loop Back Response (LBR) from its target after it sends the Loop Back Message (LBM). If no response is received, there might be a connectivity fault between them.
- Link trace test - provides additional connectivity fault analysis to get more information on where the fault is. If an MEP port does not respond to the source MEP, this may indicate a fault. Administrators can take further action to check and resume services from the fault according to the line connectivity status report.

40.3 Ping & TraceRoute & NsLookup

Use this screen to ping, traceroute, or nslookup an IP address. Click **Maintenance > Diagnostic > Ping&TraceRoute&NsLookup** to open the screen shown next.

Figure 165 Maintenance > Diagnostic > Ping &TraceRoute&NsLookup

The following table describes the fields in this screen.

Table 124 Maintenance > Diagnostic > Ping & TraceRoute & NsLookup

LABEL	DESCRIPTION
URL or IP Address	Type the IP address of a computer that you want to perform ping, traceroute, or nslookup in order to test a connection.
Ping	Click this to ping the IP address that you entered.
TraceRoute	Click this button to perform the traceroute function. This determines the path a packet takes to the specified computer.
Nslookup	Click this button to perform a DNS lookup on the IP address of a computer you enter.

40.4 802.1ag

Click **Maintenance > Diagnostic > 8.2.1ag** to open the following screen. Use this screen to perform CFM actions.

Figure 166 Maintenance > Diagnostic > 802.1ag

The following table describes the fields in this screen.

Table 125 Maintenance > Diagnostic > 802.1ag

LABEL	DESCRIPTION
802.1ag Connectivity Fault Management	
Maintenance Domain (MD) Level	Select a level (0-7) under which you want to create an MA.
Destination MAC Address	Enter the target device's MAC address to which the Device performs a CFM loopback test.
802.1Q VLAN ID	Type a VLAN ID (0-4095) for this MA.
VDSL Traffic Type	This shows whether the VDSL traffic is activated.
Loopback Message (LBM)	This shows how many Loop Back Messages (LBMs) are sent and if there is any in order or out of order Loop Back Response (LBR) received from a remote MEP.
Linktrace Message (LTM)	This shows the destination MAC address in the Link Trace Response (LTR).
Set MD Level	Click this button to configure the MD (Maintenance Domain) level.
Send Loopback	Click this button to have the selected MEP send the LBM (Loop Back Message) to a specified remote end point.
Send Linktrace	Click this button to have the selected MEP send the LTMs (Link Trace Messages) to a specified remote end point.

40.5 OAM Ping

Click **Maintenance > Diagnostic > OAM Ping** to open the screen shown next. Use this screen to perform an OAM (Operation, Administration and Maintenance) F4 or F5 loopback test on a PVC. The Device sends an OAM F4 or F5 packet to the DSLAM or ATM switch and then returns it to the Device. The test result then displays in the text box.

ATM sets up virtual circuits over which end systems communicate. The terminology for virtual circuits is as follows:

- Virtual Channel (VC) Logical connections between ATM devices
- Virtual Path (VP) A bundle of virtual channels
- Virtual Circuits A series of virtual paths between circuit end points

Figure 167 Virtual Circuit Topology

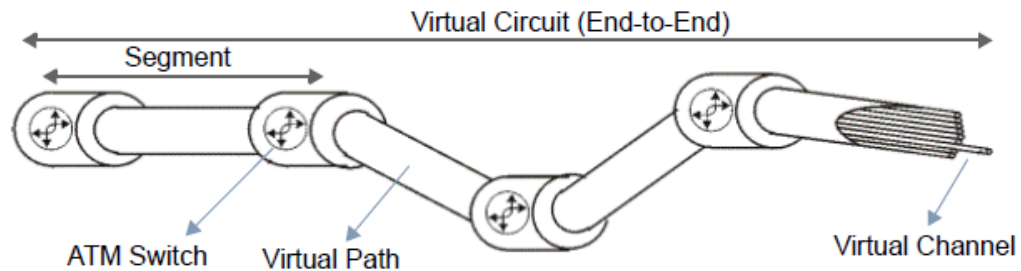

Think of a virtual path as a cable that contains a bundle of wires. The cable connects two points and wires within the cable provide individual circuits between the two points. In an ATM cell header, a VPI (Virtual Path Identifier) identifies a link formed by a virtual path; a VCI (Virtual Channel Identifier) identifies a channel within a virtual path. A series of virtual paths make up a virtual circuit.

F4 cells operate at the virtual path (VP) level, while F5 cells operate at the virtual channel (VC) level. F4 cells use the same VPI as the user data cells on VP connections, but use different predefined VCI values. F5 cells use the same VPI and VCI as the user data cells on the VC connections, and are distinguished from data cells by a predefined Payload Type Identifier (PTI) in the cell header. Both F4 flows and F5 flows are bidirectional and have two types.

- segment F4 flows (VCI=3)
- end-to-end F4 flows (VCI=4)
- segment F5 flows (PTI=100)
- end-to-end F5 flows (PTI=101)

OAM F4 or F5 tests are used to check virtual path or virtual channel availability between two DSL devices. Segment flows are terminated at the connecting point which terminates a VP or VC segment. End-to-end flows are terminated at the end point of a VP or VC connection, where an ATM link is terminated. Segment loopback tests allow you to verify integrity of a PVC to the nearest neighboring ATM device. End-to-end loopback tests allow you to verify integrity of an end-to-end PVC.

Note: The DSLAM to which the Device is connected must also support ATM F4 and/or F5 to use this test.

Note: This screen is available only when you configure an ATM layer-2 interface.

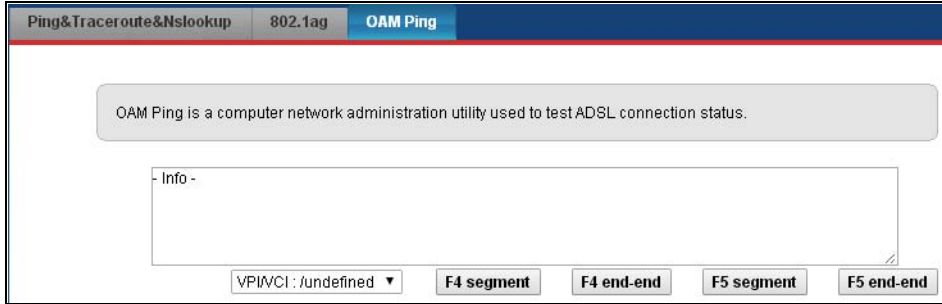
Figure 168 Maintenance > Diagnostic > OAM Ping

The following table describes the fields in this screen.

Table 126 Maintenance > Diagnostic > OAM Ping

LABEL	DESCRIPTION
	Select a PVC on which you want to perform the loopback test.
F4 segment	Press this to perform an OAM F4 segment loopback test.
F4 end-end	Press this to perform an OAM F4 end-to-end loopback test.
F5 segment	Press this to perform an OAM F5 segment loopback test.
F5 end-end	Press this to perform an OAM F5 end-to-end loopback test.

Troubleshooting

This chapter offers some suggestions to solve problems you might encounter. The potential problems are divided into the following categories.

- [Power, Hardware Connections, and LEDs](#)
- [Device Access and Login](#)
- [Internet Access](#)
- [Wireless Internet Access](#)
- [USB Device Connection](#)
- [UPnP](#)

41.1 Power, Hardware Connections, and LEDs

The Device does not turn on. None of the LEDs turn on.

- 1 Make sure the Device is turned on.
- 2 Make sure you are using the power adaptor or cord included with the Device.
- 3 Make sure the power adaptor or cord is connected to the Device and plugged in to an appropriate power source. Make sure the power source is turned on.
- 4 Turn the Device off and on.
- 5 If the problem continues, contact the vendor.

One of the LEDs does not behave as expected.

- 1 Make sure you understand the normal behavior of the LED. See [Section 1.5 on page 20](#).
- 2 Check the hardware connections.
- 3 Inspect your cables for damage. Contact the vendor to replace any damaged cables.
- 4 Turn the Device off and on.

- 5 If the problem continues, contact the vendor.

41.2 Device Access and Login

I forgot the IP address for the Device.

- 1 The default LAN IP address is 192.168.1.1.
- 2 If you changed the IP address and have forgotten it, you might get the IP address of the Device by looking up the IP address of the default gateway for your computer. To do this in most Windows computers, click **Start > Run**, enter **cmd**, and then enter **ipconfig**. The IP address of the **Default Gateway** might be the IP address of the Device (it depends on the network), so enter this IP address in your Internet browser.
- 3 If this does not work, you have to reset the device to its factory defaults. See [Section 1.6 on page 21](#).

I forgot the password.

- 1 See the cover page for the default login names and associated passwords.
- 2 If those do not work, you have to reset the device to its factory defaults. See [Section 1.6 on page 21](#).

I cannot see or access the **Login** screen in the web configurator.

- 1 Make sure you are using the correct IP address.
 - The default IP address is [192.168.1.1](#).
 - If you changed the IP address ([Section 8.2 on page 127](#)), use the new IP address.
 - If you changed the IP address and have forgotten it, see the troubleshooting suggestions for [I forgot the IP address for the Device](#).
- 2 Check the hardware connections, and make sure the LEDs are behaving as expected. See [Section 1.5 on page 20](#).
- 3 Make sure your Internet browser does not block pop-up windows and has JavaScripts and Java enabled.
- 4 If it is possible to log in from another interface, check the service control settings for HTTP and HTTPS (**Maintenance > Remote MGMT**).

- 5 Reset the device to its factory defaults, and try to access the Device with the default IP address. See [Section 1.6 on page 21](#).
- 6 If the problem continues, contact the network administrator or vendor, or try one of the advanced suggestions.

Advanced Suggestions

- Make sure you have logged out of any earlier management sessions using the same user account even if they were through a different interface or using a different browser.
- Try to access the Device using another service, such as Telnet. If you can access the Device, check the remote management settings and firewall rules to find out why the Device does not respond to HTTP.

I can see the **Login** screen, but I cannot log in to the Device.

- 1 Make sure you have entered the password correctly. See the cover page for the default login names and associated passwords. The field is case-sensitive, so make sure [Caps Lock] is not on.
- 2 You cannot log in to the web configurator while someone is using Telnet to access the Device. Log out of the Device in the other session, or ask the person who is logged in to log out.
- 3 Turn the Device off and on.
- 4 If this does not work, you have to reset the device to its factory defaults. See [Section 41.1 on page 278](#).

I cannot Telnet to the Device.

See the troubleshooting suggestions for [I cannot see or access the Login screen in the web configurator](#). Ignore the suggestions about your browser.

I cannot use FTP to upload / download the configuration file. / I cannot use FTP to upload new firmware.

See the troubleshooting suggestions for [I cannot see or access the Login screen in the web configurator](#). Ignore the suggestions about your browser.

41.3 Internet Access

I cannot access the Internet.

- 1 Check the hardware connections, and make sure the LEDs are behaving as expected. See the **Quick Start Guide** and [Section 1.5 on page 20](#).
- 2 Make sure you entered your ISP account information correctly in the **Network Setting > Broadband** screen. These fields are case-sensitive, so make sure [Caps Lock] is not on.
- 3 If you are trying to access the Internet wirelessly, make sure that you enabled the wireless LAN in the Device and your wireless client and that the wireless settings in the wireless client are the same as the settings in the Device.
- 4 Disconnect all the cables from your device and reconnect them.
- 5 If the problem continues, contact your ISP.

I cannot access the Internet through a DSL connection.

- 1 Make sure you have the **DSL WAN** port connected to a telephone jack (or the DSL or modem jack on a splitter if you have one).
- 2 Make sure you configured a proper DSL WAN interface (**Network Setting > Broadband** screen) with the Internet account information provided by your ISP and that it is enabled.
- 3 Check that the LAN interface you are connected to is in the same interface group as the DSL connection (**Network Setting > Interface Group**).
- 4 If you set up a WAN connection using bridging service, make sure you turn off the DHCP feature in the **LAN** screen to have the clients get WAN IP addresses directly from your ISP's DHCP server.

I cannot connect to the Internet using a second DSL connection.

ADSL and VDSL connections cannot work at the same time. You can only use one type of DSL connection, either ADSL or VDSL connection at one time.

I cannot connect to the Internet using an Ethernet connection.

- 1 The DSL connection has priority. If the DSL connection is up, then the Ethernet connection will be down.

- 2 Make sure you have the Ethernet WAN port connected to a MODEM or Router.
- 3 Make sure you converted LAN port number four as WAN. Click **Enable** in **Network Setting > Broadband > Ethernet WAN** screen.
- 4 Make sure you configured a proper EthernetWAN interface (**Network Setting > Broadband** screen) with the Internet account information provided by your ISP and that it is enabled.
- 5 Check that the WAN interface you are connected to is in the same interface group as the Ethernet connection (**Network Setting > Interface Group**).
- 6 If you set up a WAN connection using bridging service, make sure you turn off the DHCP feature in the **LAN** screen to have the clients get WAN IP addresses directly from your ISP's DHCP server.

I cannot connect to the Internet using a 3G connection.

- 1 The DSL and Ethernet connections have priority in that order. If the DSL or Ethernet connection is up, then the 3G connection will be down.
- 2 Make sure you have connected a compatible 3G dongle to the USB port.
- 3 Make sure you have configured **Network Setting > Broadband > 3G Backup** correctly.

Check that the Device is within range of a 3G base station. I cannot access the Device anymore. I had access to the Device, but my connection is not available anymore.

- 1 Your session with the Device may have expired. Try logging into the Device again.
- 2 Check the hardware connections, and make sure the LEDs are behaving as expected. See the **Quick Start Guide** and [Section 1.5 on page 20](#).
- 3 Turn the Device off and on.
- 4 If the problem continues, contact your vendor.

41.4 Wireless Internet Access

What factors may cause intermittent or unstabled wireless connection? How can I solve this problem?

The following factors may cause interference:

- Obstacles: walls, ceilings, furniture, and so on.

- Building Materials: metal doors, aluminum studs.
- Electrical devices: microwaves, monitors, electric motors, cordless phones, and other wireless devices.

To optimize the speed and quality of your wireless connection, you can:

- Move your wireless device closer to the AP if the signal strength is low.
- Reduce wireless interference that may be caused by other wireless networks or surrounding wireless electronics such as cordless phones.
- Place the AP where there are minimum obstacles (such as walls and ceilings) between the AP and the wireless client.
- Reduce the number of wireless clients connecting to the same AP simultaneously, or add additional APs if necessary.
- Try closing some programs that use the Internet, especially peer-to-peer applications. If the wireless client is sending or receiving a lot of information, it may have too many programs open that use the Internet.

What is a Server Set ID (SSID)?

An SSID is a name that uniquely identifies a wireless network. The AP and all the clients within a wireless network must use the same SSID.

41.5 USB Device Connection

The Device fails to detect my USB device.

- 1 Disconnect the USB device.
- 2 Reboot the Device.
- 3 If you are connecting a USB hard drive that comes with an external power supply, make sure it is connected to an appropriate power source that is on.
- 4 Re-connect your USB device to the Device.

41.6 UPnP

When using UPnP and the Device reboots, my computer cannot detect UPnP and refresh **My Network Places > Local Network**.

- 1 Disconnect the Ethernet cable from the Device's LAN port or from your computer.
- 2 Re-connect the Ethernet cable.

The **Local Area Connection** icon for UPnP disappears in the screen.

Restart your computer.

PART III

Appendices

Appendices contain general information. Some information may not apply to your device.

Customer Support

In the event of problems that cannot be solved by using this manual, you should contact your vendor. If you cannot contact your vendor, then contact a ZyXEL office for the region in which you bought the device.

See <http://www.zyxel.com/homepage.shtml> and also

http://www.zyxel.com/about_zyxel/zyxel_worldwide.shtml for the latest information.

Please have the following information ready when you contact an office.

Required Information

- Product model and serial number.
- Warranty Information.
- Date that you received your device.
- Brief description of the problem and the steps you took to solve it.

Corporate Headquarters (Worldwide)

Taiwan

- ZyXEL Communications Corporation
- <http://www.zyxel.com>

Asia

China

- ZyXEL Communications (Shanghai) Corp.
- ZyXEL Communications (Beijing) Corp.
- ZyXEL Communications (Tianjin) Corp.
- <http://www.zyxel.cn>

India

- ZyXEL Technology India Pvt Ltd
- <http://www.zyxel.in>

Kazakhstan

- ZyXEL Kazakhstan

- <http://www.zyxel.kz>

Korea

- ZyXEL Korea Corp.
- <http://www.zyxel.kr>

Malaysia

- ZyXEL Malaysia Sdn Bhd.
- <http://www.zyxel.com.my>

Pakistan

- ZyXEL Pakistan (Pvt.) Ltd.
- <http://www.zyxel.com.pk>

Philippines

- ZyXEL Philippines
- <http://www.zyxel.com.ph>

Singapore

- ZyXEL Singapore Pte Ltd.
- <http://www.zyxel.com.sg>

Taiwan

- ZyXEL Communications Corporation
- <http://www.zyxel.com/tw/zh/>

Thailand

- ZyXEL Thailand Co., Ltd
- <http://www.zyxel.co.th>

Vietnam

- ZyXEL Communications Corporation-Vietnam Office
- <http://www.zyxel.com/vn/vi>

Europe

Austria

- ZyXEL Deutschland GmbH
- <http://www.zyxel.de>

Belarus

- ZyXEL BY
- <http://www.zyxel.by>

Belgium

- ZyXEL Communications B.V.
- <http://www.zyxel.com/be/nl/>
- <http://www.zyxel.com/be/fr/>

Bulgaria

- ZyXEL България
- <http://www.zyxel.com/bg/bg/>

Czech Republic

- ZyXEL Communications Czech s.r.o
- <http://www.zyxel.cz>

Denmark

- ZyXEL Communications A/S
- <http://www.zyxel.dk>

Estonia

- ZyXEL Estonia
- <http://www.zyxel.com/ee/et/>

Finland

- ZyXEL Communications
- <http://www.zyxel.fi>

France

- ZyXEL France
- <http://www.zyxel.fr>

Germany

- ZyXEL Deutschland GmbH
- <http://www.zyxel.de>

Hungary

- ZyXEL Hungary & SEE
- <http://www.zyxel.hu>

Italy

- ZyXEL Communications Italy
- <http://www.zyxel.it/>

Latvia

- ZyXEL Latvia
- <http://www.zyxel.com/lv/lv/homepage.shtml>

Lithuania

- ZyXEL Lithuania
- <http://www.zyxel.com/lt/lt/homepage.shtml>

Netherlands

- ZyXEL Benelux
- <http://www.zyxel.nl>

Norway

- ZyXEL Communications
- <http://www.zyxel.no>

Poland

- ZyXEL Communications Poland
- <http://www.zyxel.pl>

Romania

- ZyXEL Romania
- <http://www.zyxel.com/ro/ro>

Russia

- ZyXEL Russia
- <http://www.zyxel.ru>

Slovakia

- ZyXEL Communications Czech s.r.o. organizacna zlozka
- <http://www.zyxel.sk>

Spain

- ZyXEL Communications ES Ltd
- <http://www.zyxel.es>

Sweden

- ZyXEL Communications

- <http://www.zyxel.se>

Switzerland

- Studerus AG
- <http://www.zyxel.ch/>

Turkey

- ZyXEL Turkey A.S.
- <http://www.zyxel.com.tr>

UK

- ZyXEL Communications UK Ltd.
- <http://www.zyxel.co.uk>

Ukraine

- ZyXEL Ukraine
- <http://www.ua.zyxel.com>

Latin America

Argentina

- ZyXEL Communication Corporation
- <http://www.zyxel.com/ec/es/>

Brazil

- ZyXEL Communications Brasil Ltda.
- <https://www.zyxel.com/br/pt/>

Ecuador

- ZyXEL Communication Corporation
- <http://www.zyxel.com/ec/es/>

Middle East

Israel

- ZyXEL Communication Corporation
- <http://il.zyxel.com/homepage.shtml>

Middle East

- ZyXEL Communication Corporation

- <http://www.zyxel.com/me/en/>

North America

USA

- ZyXEL Communications, Inc. - North America Headquarters
- <http://www.zyxel.com/us/en/>

Oceania

Australia

- ZyXEL Communications Corporation
- <http://www.zyxel.com/au/en/>

Africa

South Africa

- Nology (Pty) Ltd.
- <http://www.zyxel.co.za>

Wireless LANs

Wireless LAN Topologies

This section discusses ad-hoc and infrastructure wireless LAN topologies.

Ad-hoc Wireless LAN Configuration

The simplest WLAN configuration is an independent (Ad-hoc) WLAN that connects a set of computers with wireless adapters (A, B, C). Any time two or more wireless adapters are within range of each other, they can set up an independent network, which is commonly referred to as an ad-hoc network or Independent Basic Service Set (IBSS). The following diagram shows an example of notebook computers using wireless adapters to form an ad-hoc wireless LAN.

Figure 169 Peer-to-Peer Communication in an Ad-hoc Network

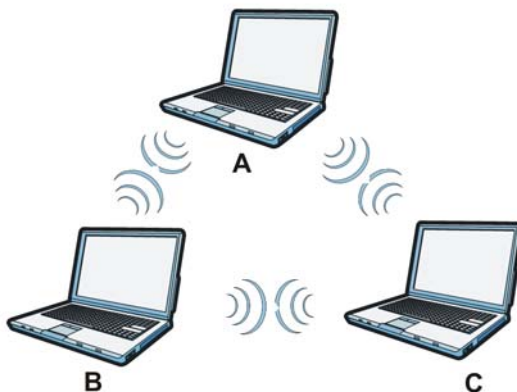

BSS

A Basic Service Set (BSS) exists when all communications between wireless clients or between a wireless client and a wired network client go through one access point (AP).

Intra-BSS traffic is traffic between wireless clients in the BSS. When Intra-BSS is enabled, wireless client **A** and **B** can access the wired network and communicate with each other. When Intra-BSS is disabled, wireless client **A** and **B** can still access the wired network but cannot communicate with each other.

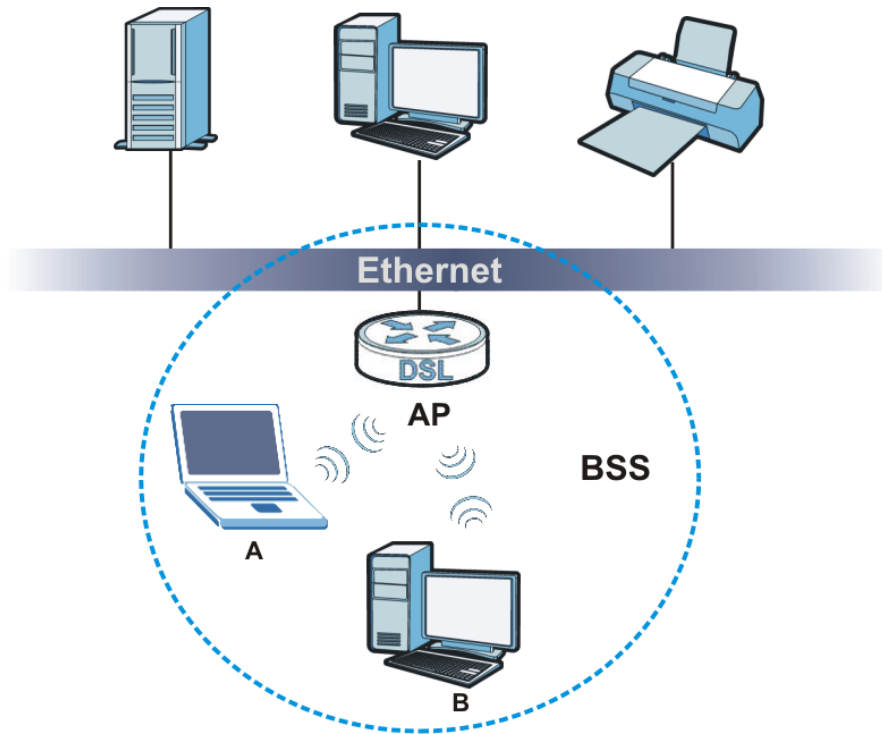
Figure 170 Basic Service Set

ESS

An Extended Service Set (ESS) consists of a series of overlapping BSSs, each containing an access point, with each access point connected together by a wired network. This wired connection between APs is called a Distribution System (DS).

This type of wireless LAN topology is called an Infrastructure WLAN. The Access Points not only provide communication with the wired network but also mediate wireless network traffic in the immediate neighborhood.

An ESSID (ESS IDentification) uniquely identifies each ESS. All access points and their associated wireless clients within the same ESS must have the same ESSID in order to communicate.

Figure 171 Infrastructure WLAN

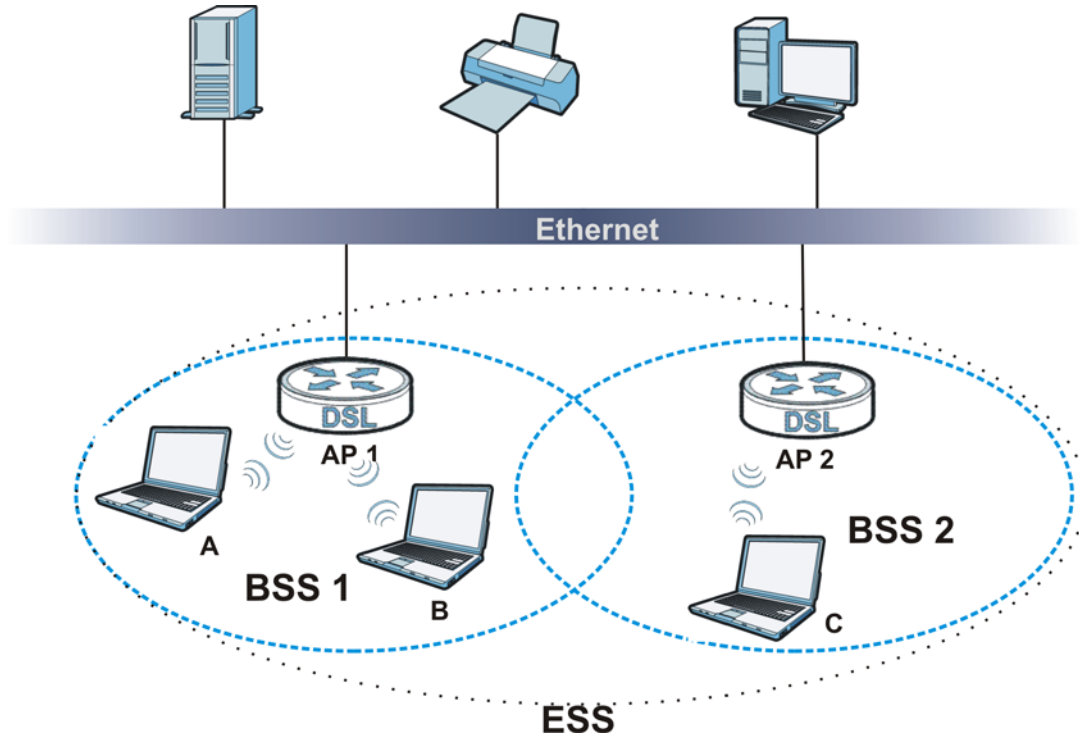

Channel

A channel is the radio frequency(ies) used by wireless devices to transmit and receive data. Channels available depend on your geographical area. You may have a choice of channels (for your region) so you should use a channel different from an adjacent AP (access point) to reduce interference. Interference occurs when radio signals from different access points overlap causing interference and degrading performance.

Adjacent channels partially overlap however. To avoid interference due to overlap, your AP should be on a channel at least five channels away from a channel that an adjacent AP is using. For example, if your region has 11 channels and an adjacent AP is using channel 1, then you need to select a channel between 6 or 11.

RTS/CTS

A hidden node occurs when two stations are within range of the same access point, but are not within range of each other. The following figure illustrates a hidden node. Both stations (STA) are within range of the access point (AP) or wireless gateway, but out-of-range of each other, so they cannot "hear" each other, that is they do not know if the channel is currently being used. Therefore, they are considered hidden from each other.

Figure 172 RTS/CTS

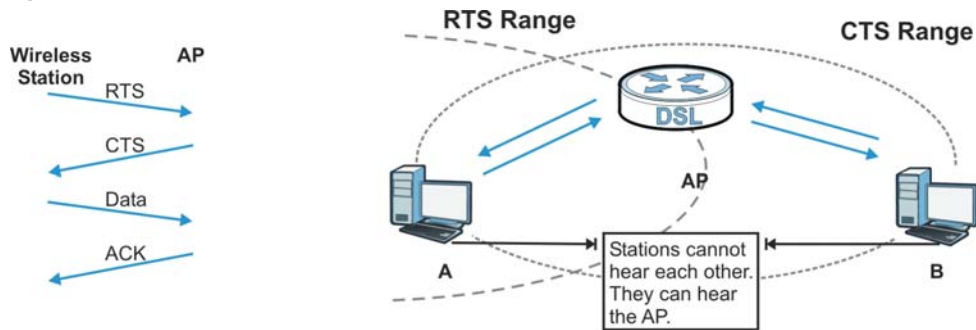

When station **A** sends data to the AP, it might not know that the station **B** is already using the channel. If these two stations send data at the same time, collisions may occur when both sets of data arrive at the AP at the same time, resulting in a loss of messages for both stations.

RTS/CTS is designed to prevent collisions due to hidden nodes. An **RTS/CTS** defines the biggest size data frame you can send before an RTS (Request To Send)/CTS (Clear to Send) handshake is invoked.

When a data frame exceeds the **RTS/CTS** value you set (between 0 to 2432 bytes), the station that wants to transmit this frame must first send an RTS (Request To Send) message to the AP for permission to send it. The AP then responds with a CTS (Clear to Send) message to all other stations within its range to notify them to defer their transmission. It also reserves and confirms with the requesting station the time frame for the requested transmission.

Stations can send frames smaller than the specified **RTS/CTS** directly to the AP without the RTS (Request To Send)/CTS (Clear to Send) handshake.

You should only configure **RTS/CTS** if the possibility of hidden nodes exists on your network and the "cost" of resending large frames is more than the extra network overhead involved in the RTS (Request To Send)/CTS (Clear to Send) handshake.

If the **RTS/CTS** value is greater than the **Fragmentation Threshold** value (see next), then the RTS (Request To Send)/CTS (Clear to Send) handshake will never occur as data frames will be fragmented before they reach **RTS/CTS** size.

Note: Enabling the RTS Threshold causes redundant network overhead that could negatively affect the throughput performance instead of providing a remedy.

Fragmentation Threshold

A **Fragmentation Threshold** is the maximum data fragment size (between 256 and 2432 bytes) that can be sent in the wireless network before the AP will fragment the packet into smaller data frames.

A large **Fragmentation Threshold** is recommended for networks not prone to interference while you should set a smaller threshold for busy networks or networks that are prone to interference.

If the **Fragmentation Threshold** value is smaller than the **RTS/CTS** value (see previously) you set then the RTS (Request To Send)/CTS (Clear to Send) handshake will never occur as data frames will be fragmented before they reach **RTS/CTS** size.

IEEE 802.11g Wireless LAN

IEEE 802.11g is fully compatible with the IEEE 802.11b standard. This means an IEEE 802.11b adapter can interface directly with an IEEE 802.11g access point (and vice versa) at 11 Mbps or lower depending on range. IEEE 802.11g has several intermediate rate steps between the maximum and minimum data rates. The IEEE 802.11g data rate and modulation are as follows:

Table 127 IEEE 802.11g

DATA RATE (MBPS)	MODULATION
1	DBPSK (Differential Binary Phase Shift Keyed)
2	DQPSK (Differential Quadrature Phase Shift Keying)
5.5 / 11	CCK (Complementary Code Keying)
6/9/12/18/24/36/48/ 54	OFDM (Orthogonal Frequency Division Multiplexing)

Wireless Security Overview

Wireless security is vital to your network to protect wireless communication between wireless clients, access points and the wired network.

Wireless security methods available on the Device are data encryption, wireless client authentication, restricting access by device MAC address and hiding the Device identity.

The following figure shows the relative effectiveness of these wireless security methods available on your Device.

Table 128 Wireless Security Levels

SECURITY LEVEL	SECURITY TYPE
Least Secure	Unique SSID (Default)
	Unique SSID with Hide SSID Enabled
	MAC Address Filtering
	WEP Encryption
	IEEE802.1x EAP with RADIUS Server Authentication
Most Secure	Wi-Fi Protected Access (WPA)
	WPA2

Note: You must enable the same wireless security settings on the Device and on all wireless clients that you want to associate with it.

IEEE 802.1x

In June 2001, the IEEE 802.1x standard was designed to extend the features of IEEE 802.11 to support extended authentication as well as providing additional accounting and control features. It is supported by Windows XP and a number of network devices. Some advantages of IEEE 802.1x are:

- User based identification that allows for roaming.

- Support for RADIUS (Remote Authentication Dial In User Service, RFC 2138, 2139) for centralized user profile and accounting management on a network RADIUS server.
- Support for EAP (Extensible Authentication Protocol, RFC 2486) that allows additional authentication methods to be deployed with no changes to the access point or the wireless clients.

RADIUS

RADIUS is based on a client-server model that supports authentication, authorization and accounting. The access point is the client and the server is the RADIUS server. The RADIUS server handles the following tasks:

- Authentication
Determines the identity of the users.
- Authorization
Determines the network services available to authenticated users once they are connected to the network.
- Accounting
Keeps track of the client's network activity.

RADIUS is a simple package exchange in which your AP acts as a message relay between the wireless client and the network RADIUS server.

Types of RADIUS Messages

The following types of RADIUS messages are exchanged between the access point and the RADIUS server for user authentication:

- Access-Request
Sent by an access point requesting authentication.
- Access-Reject
Sent by a RADIUS server rejecting access.
- Access-Accept
Sent by a RADIUS server allowing access.
- Access-Challenge
Sent by a RADIUS server requesting more information in order to allow access. The access point sends a proper response from the user and then sends another Access-Request message.

The following types of RADIUS messages are exchanged between the access point and the RADIUS server for user accounting:

- Accounting-Request
Sent by the access point requesting accounting.
- Accounting-Response
Sent by the RADIUS server to indicate that it has started or stopped accounting.

In order to ensure network security, the access point and the RADIUS server use a shared secret key, which is a password, they both know. The key is not sent over the network. In addition to the

shared key, password information exchanged is also encrypted to protect the network from unauthorized access.

Types of EAP Authentication

This section discusses some popular authentication types: EAP-MD5, EAP-TLS, EAP-TTLS, PEAP and LEAP. Your wireless LAN device may not support all authentication types.

EAP (Extensible Authentication Protocol) is an authentication protocol that runs on top of the IEEE 802.1x transport mechanism in order to support multiple types of user authentication. By using EAP to interact with an EAP-compatible RADIUS server, an access point helps a wireless station and a RADIUS server perform authentication.

The type of authentication you use depends on the RADIUS server and an intermediary AP(s) that supports IEEE 802.1x.

For EAP-TLS authentication type, you must first have a wired connection to the network and obtain the certificate(s) from a certificate authority (CA). A certificate (also called digital IDs) can be used to authenticate users and a CA issues certificates and guarantees the identity of each certificate owner.

EAP-MD5 (Message-Digest Algorithm 5)

MD5 authentication is the simplest one-way authentication method. The authentication server sends a challenge to the wireless client. The wireless client 'proves' that it knows the password by encrypting the password with the challenge and sends back the information. Password is not sent in plain text.

However, MD5 authentication has some weaknesses. Since the authentication server needs to get the plaintext passwords, the passwords must be stored. Thus someone other than the authentication server may access the password file. In addition, it is possible to impersonate an authentication server as MD5 authentication method does not perform mutual authentication. Finally, MD5 authentication method does not support data encryption with dynamic session key. You must configure WEP encryption keys for data encryption.

EAP-TLS (Transport Layer Security)

With EAP-TLS, digital certifications are needed by both the server and the wireless clients for mutual authentication. The server presents a certificate to the client. After validating the identity of the server, the client sends a different certificate to the server. The exchange of certificates is done in the open before a secured tunnel is created. This makes user identity vulnerable to passive attacks. A digital certificate is an electronic ID card that authenticates the sender's identity. However, to implement EAP-TLS, you need a Certificate Authority (CA) to handle certificates, which imposes a management overhead.

EAP-TTLS (Tunneled Transport Layer Service)

EAP-TTLS is an extension of the EAP-TLS authentication that uses certificates for only the server-side authentications to establish a secure connection. Client authentication is then done by sending username and password through the secure connection, thus client identity is protected. For client authentication, EAP-TTLS supports EAP methods and legacy authentication methods such as PAP, CHAP, MS-CHAP and MS-CHAP v2.

PEAP (Protected EAP)

Like EAP-TTLS, server-side certificate authentication is used to establish a secure connection, then use simple username and password methods through the secured connection to authenticate the clients, thus hiding client identity. However, PEAP only supports EAP methods, such as EAP-MD5, EAP-MSCHAPv2 and EAP-GTC (EAP-Generic Token Card), for client authentication. EAP-GTC is implemented only by Cisco.

LEAP

LEAP (Lightweight Extensible Authentication Protocol) is a Cisco implementation of IEEE 802.1x.

Dynamic WEP Key Exchange

The AP maps a unique key that is generated with the RADIUS server. This key expires when the wireless connection times out, disconnects or reauthentication times out. A new WEP key is generated each time reauthentication is performed.

If this feature is enabled, it is not necessary to configure a default encryption key in the wireless security configuration screen. You may still configure and store keys, but they will not be used while dynamic WEP is enabled.

Note: EAP-MD5 cannot be used with Dynamic WEP Key Exchange

For added security, certificate-based authentications (EAP-TLS, EAP-TTLS and PEAP) use dynamic keys for data encryption. They are often deployed in corporate environments, but for public deployment, a simple user name and password pair is more practical. The following table is a comparison of the features of authentication types.

Table 129 Comparison of EAP Authentication Types

	EAP-MD5	EAP-TLS	EAP-TTLS	PEAP	LEAP
Mutual Authentication	No	Yes	Yes	Yes	Yes
Certificate – Client	No	Yes	Optional	Optional	No
Certificate – Server	No	Yes	Yes	Yes	No
Dynamic Key Exchange	No	Yes	Yes	Yes	Yes
Credential Integrity	None	Strong	Strong	Strong	Moderate
Deployment Difficulty	Easy	Hard	Moderate	Moderate	Moderate
Client Identity Protection	No	No	Yes	Yes	No

WPA and WPA2

Wi-Fi Protected Access (WPA) is a subset of the IEEE 802.11i standard. WPA2 (IEEE 802.11i) is a wireless security standard that defines stronger encryption, authentication and key management than WPA.

Key differences between WPA or WPA2 and WEP are improved data encryption and user authentication.

If both an AP and the wireless clients support WPA2 and you have an external RADIUS server, use WPA2 for stronger data encryption. If you don't have an external RADIUS server, you should use

WPA2-PSK (WPA2-Pre-Shared Key) that only requires a single (identical) password entered into each access point, wireless gateway and wireless client. As long as the passwords match, a wireless client will be granted access to a WLAN.

If the AP or the wireless clients do not support WPA2, just use WPA or WPA-PSK depending on whether you have an external RADIUS server or not.

Select WEP only when the AP and/or wireless clients do not support WPA or WPA2. WEP is less secure than WPA or WPA2.

Encryption

WPA improves data encryption by using Temporal Key Integrity Protocol (TKIP), Message Integrity Check (MIC) and IEEE 802.1x. WPA2 also uses TKIP when required for compatibility reasons, but offers stronger encryption than TKIP with Advanced Encryption Standard (AES) in the Counter mode with Cipher block chaining Message authentication code Protocol (CCMP).

TKIP uses 128-bit keys that are dynamically generated and distributed by the authentication server. AES (Advanced Encryption Standard) is a block cipher that uses a 256-bit mathematical algorithm called Rijndael. They both include a per-packet key mixing function, a Message Integrity Check (MIC) named Michael, an extended initialization vector (IV) with sequencing rules, and a re-keying mechanism.

WPA and WPA2 regularly change and rotate the encryption keys so that the same encryption key is never used twice.

The RADIUS server distributes a Pairwise Master Key (PMK) key to the AP that then sets up a key hierarchy and management system, using the PMK to dynamically generate unique data encryption keys to encrypt every data packet that is wirelessly communicated between the AP and the wireless clients. This all happens in the background automatically.

The Message Integrity Check (MIC) is designed to prevent an attacker from capturing data packets, altering them and resending them. The MIC provides a strong mathematical function in which the receiver and the transmitter each compute and then compare the MIC. If they do not match, it is assumed that the data has been tampered with and the packet is dropped.

By generating unique data encryption keys for every data packet and by creating an integrity checking mechanism (MIC), with TKIP and AES it is more difficult to decrypt data on a Wi-Fi network than WEP and difficult for an intruder to break into the network.

The encryption mechanisms used for WPA(2) and WPA(2)-PSK are the same. The only difference between the two is that WPA(2)-PSK uses a simple common password, instead of user-specific credentials. The common-password approach makes WPA(2)-PSK susceptible to brute-force password-guessing attacks but it's still an improvement over WEP as it employs a consistent, single, alphanumeric password to derive a PMK which is used to generate unique temporal encryption keys. This prevents all wireless devices sharing the same encryption keys. (a weakness of WEP)

User Authentication

WPA and WPA2 apply IEEE 802.1x and Extensible Authentication Protocol (EAP) to authenticate wireless clients using an external RADIUS database. WPA2 reduces the number of key exchange messages from six to four (CCMP 4-way handshake) and shortens the time required to connect to a network. Other WPA2 authentication features that are different from WPA include key caching and

pre-authentication. These two features are optional and may not be supported in all wireless devices.

Key caching allows a wireless client to store the PMK it derived through a successful authentication with an AP. The wireless client uses the PMK when it tries to connect to the same AP and does not need to go through the authentication process again.

Pre-authentication enables fast roaming by allowing the wireless client (already connecting to an AP) to perform IEEE 802.1x authentication with another AP before connecting to it.

Wireless Client WPA Supplicants

A wireless client supplicant is the software that runs on an operating system instructing the wireless client how to use WPA. At the time of writing, the most widely available supplicant is the WPA patch for Windows XP, Funk Software's Odyssey client.

The Windows XP patch is a free download that adds WPA capability to Windows XP's built-in "Zero Configuration" wireless client. However, you must run Windows XP to use it.

WPA(2) with RADIUS Application Example

To set up WPA(2), you need the IP address of the RADIUS server, its port number (default is 1812), and the RADIUS shared secret. A WPA(2) application example with an external RADIUS server looks as follows. "A" is the RADIUS server. "DS" is the distribution system.

- 1 The AP passes the wireless client's authentication request to the RADIUS server.
- 2 The RADIUS server then checks the user's identification against its database and grants or denies network access accordingly.
- 3 A 256-bit Pairwise Master Key (PMK) is derived from the authentication process by the RADIUS server and the client.
- 4 The RADIUS server distributes the PMK to the AP. The AP then sets up a key hierarchy and management system, using the PMK to dynamically generate unique data encryption keys. The keys are used to encrypt every data packet that is wirelessly communicated between the AP and the wireless clients.

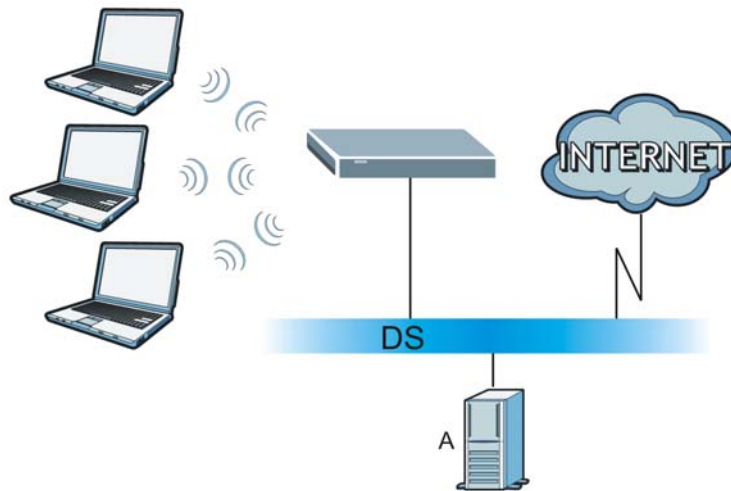
Figure 173 WPA(2) with RADIUS Application Example

WPA(2)-PSK Application Example

A WPA(2)-PSK application looks as follows.

- 1 First enter identical passwords into the AP and all wireless clients. The Pre-Shared Key (PSK) must consist of between 8 and 63 ASCII characters or 64 hexadecimal characters (including spaces and symbols).
- 2 The AP checks each wireless client's password and allows it to join the network only if the password matches.
- 3 The AP and wireless clients generate a common PMK (Pairwise Master Key). The key itself is not sent over the network, but is derived from the PSK and the SSID.
- 4 The AP and wireless clients use the TKIP or AES encryption process, the PMK and information exchanged in a handshake to create temporal encryption keys. They use these keys to encrypt data exchanged between them.

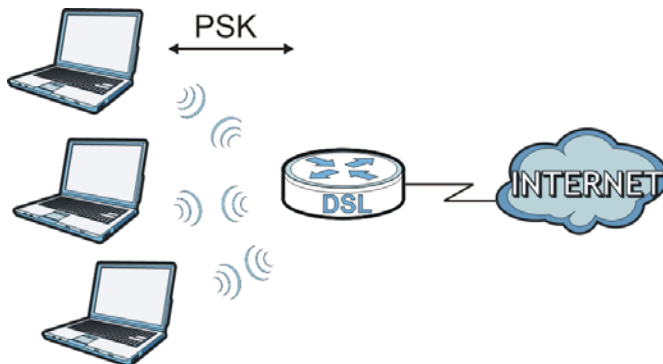
Figure 174 WPA(2)-PSK Authentication

Security Parameters Summary

Refer to this table to see what other security parameters you should configure for each authentication method or key management protocol type. MAC address filters are not dependent on how you configure these security features.

Table 130 Wireless Security Relational Matrix

AUTHENTICATION METHOD/ KEY MANAGEMENT PROTOCOL	ENCRYPTION METHOD	ENTER MANUAL KEY	IEEE 802.1X
Open	None	No	Disable
			Enable without Dynamic WEP Key
Open	WEP	No	Enable with Dynamic WEP Key
		Yes	Enable without Dynamic WEP Key
		Yes	Disable
Shared	WEP	No	Enable with Dynamic WEP Key
		Yes	Enable without Dynamic WEP Key
		Yes	Disable
WPA	TKIP/AES	No	Enable
WPA-PSK	TKIP/AES	Yes	Disable
WPA2	TKIP/AES	No	Enable
WPA2-PSK	TKIP/AES	Yes	Disable

Antenna Overview

An antenna couples RF signals onto air. A transmitter within a wireless device sends an RF signal to the antenna, which propagates the signal through the air. The antenna also operates in reverse by capturing RF signals from the air.

Positioning the antennas properly increases the range and coverage area of a wireless LAN.

Antenna Characteristics

Frequency

An antenna in the frequency of 2.4GHz (IEEE 802.11b and IEEE 802.11g) is needed to communicate efficiently in a wireless LAN

Radiation Pattern

A radiation pattern is a diagram that allows you to visualize the shape of the antenna's coverage area.

Antenna Gain

Antenna gain, measured in dB (decibel), is the increase in coverage within the RF beam width. Higher antenna gain improves the range of the signal for better communications.

For an indoor site, each 1 dB increase in antenna gain results in a range increase of approximately

2.5%. For an unobstructed outdoor site, each 1dB increase in gain results in a range increase of approximately 5%. Actual results may vary depending on the network environment.

Antenna gain is sometimes specified in dBi, which is how much the antenna increases the signal power compared to using an isotropic antenna. An isotropic antenna is a theoretical perfect antenna that sends out radio signals equally well in all directions. dBi represents the true gain that the antenna provides.

Types of Antennas for WLAN

There are two types of antennas used for wireless LAN applications.

- Omni-directional antennas send the RF signal out in all directions on a horizontal plane. The coverage area is torus-shaped (like a donut) which makes these antennas ideal for a room environment. With a wide coverage area, it is possible to make circular overlapping coverage areas with multiple access points.
- Directional antennas concentrate the RF signal in a beam, like a flashlight does with the light from its bulb. The angle of the beam determines the width of the coverage pattern. Angles typically range from 20 degrees (very directional) to 120 degrees (less directional). Directional antennas are ideal for hallways and outdoor point-to-point applications.

Positioning Antennas

In general, antennas should be mounted as high as practically possible and free of obstructions. In point-to-point application, position both antennas at the same height and in a direct line of sight to each other to attain the best performance.

For omni-directional antennas mounted on a table, desk, and so on, point the antenna up. For omni-directional antennas mounted on a wall or ceiling, point the antenna down. For a single AP application, place omni-directional antennas as close to the center of the coverage area as possible.

For directional antennas, point the antenna in the direction of the desired coverage area.

Overview

IPv6 (Internet Protocol version 6), is designed to enhance IP address size and features. The increase in IPv6 address size to 128 bits (from the 32-bit IPv4 address) allows up to 3.4×10^{38} IP addresses.

IPv6 Addressing

The 128-bit IPv6 address is written as eight 16-bit hexadecimal blocks separated by colons (:). This is an example IPv6 address `2001:0db8:1a2b:0015:0000:0000:1a2f:0000`.

IPv6 addresses can be abbreviated in two ways:

- Leading zeros in a block can be omitted. So `2001:0db8:1a2b:0015:0000:0000:1a2f:0000` can be written as `2001:db8:1a2b:15:0:0:1a2f:0`.
- Any number of consecutive blocks of zeros can be replaced by a double colon. A double colon can only appear once in an IPv6 address. So `2001:0db8:0000:0000:1a2f:0000:0000:0015` can be written as `2001:0db8::1a2f:0000:0000:0015`, `2001:0db8:0000:0000:1a2f::0015`, `2001:db8::1a2f:0:0:15` or `2001:db8:0:0:1a2f::15`.

Prefix and Prefix Length

Similar to an IPv4 subnet mask, IPv6 uses an address prefix to represent the network address. An IPv6 prefix length specifies how many most significant bits (start from the left) in the address compose the network address. The prefix length is written as "/x" where x is a number. For example,

```
2001:db8:1a2b:15::1a2f:0/32
```

means that the first 32 bits (`2001:db8`) is the subnet prefix.

Link-local Address

A link-local address uniquely identifies a device on the local network (the LAN). It is similar to a "private IP address" in IPv4. You can have the same link-local address on multiple interfaces on a device. A link-local unicast address has a predefined prefix of `fe80::/10`. The link-local unicast address format is as follows.

Table 131 Link-local Unicast Address Format

1111 1110 10	0	Interface ID
10 bits	54 bits	64 bits

Global Address

A global address uniquely identifies a device on the Internet. It is similar to a “public IP address” in IPv4. A global unicast address starts with a 2 or 3.

Unspecified Address

An unspecified address (0:0:0:0:0:0:0 or ::) is used as the source address when a device does not have its own address. It is similar to “0.0.0.0” in IPv4.

Loopback Address

A loopback address (0:0:0:0:0:0:0:1 or ::1) allows a host to send packets to itself. It is similar to “127.0.0.1” in IPv4.

Multicast Address

In IPv6, multicast addresses provide the same functionality as IPv4 broadcast addresses. Broadcasting is not supported in IPv6. A multicast address allows a host to send packets to all hosts in a multicast group.

Multicast scope allows you to determine the size of the multicast group. A multicast address has a predefined prefix of ff00::/8. The following table describes some of the predefined multicast addresses.

Table 132 Predefined Multicast Address

MULTICAST ADDRESS	DESCRIPTION
FF01:0:0:0:0:0:0:1	All hosts on a local node.
FF01:0:0:0:0:0:0:2	All routers on a local node.
FF02:0:0:0:0:0:0:1	All hosts on a local connected link.
FF02:0:0:0:0:0:0:2	All routers on a local connected link.
FF05:0:0:0:0:0:0:2	All routers on a local site.
FF05:0:0:0:0:0:1:3	All DHCP servers on a local site.

The following table describes the multicast addresses which are reserved and can not be assigned to a multicast group.

Table 133 Reserved Multicast Address

MULTICAST ADDRESS
FF00:0:0:0:0:0:0:0
FF01:0:0:0:0:0:0:0
FF02:0:0:0:0:0:0:0
FF03:0:0:0:0:0:0:0
FF04:0:0:0:0:0:0:0
FF05:0:0:0:0:0:0:0
FF06:0:0:0:0:0:0:0
FF07:0:0:0:0:0:0:0

Table 133 Reserved Multicast Address (continued)

MULTICAST ADDRESS
FF08:0:0:0:0:0:0:0
FF09:0:0:0:0:0:0:0
FF0A:0:0:0:0:0:0:0
FF0B:0:0:0:0:0:0:0
FF0C:0:0:0:0:0:0:0
FF0D:0:0:0:0:0:0:0
FF0E:0:0:0:0:0:0:0
FF0F:0:0:0:0:0:0:0

Subnet Masking

Both an IPv6 address and IPv6 subnet mask compose of 128-bit binary digits, which are divided into eight 16-bit blocks and written in hexadecimal notation. Hexadecimal uses four bits for each character (1 ~ 10, A ~ F). Each block's 16 bits are then represented by four hexadecimal characters. For example, FFFF:FFFF:FFFF:FFFF:FC00:0000:0000:0000.

Interface ID

In IPv6, an interface ID is a 64-bit identifier. It identifies a physical interface (for example, an Ethernet port) or a virtual interface (for example, the management IP address for a VLAN). One interface should have a unique interface ID.

EUI-64

The EUI-64 (Extended Unique Identifier) defined by the IEEE (Institute of Electrical and Electronics Engineers) is an interface ID format designed to adapt with IPv6. It is derived from the 48-bit (6-byte) Ethernet MAC address as shown next. EUI-64 inserts the hex digits ffe between the third and fourth bytes of the MAC address and complements the seventh bit of the first byte of the MAC address. See the following example.

MAC	00 : 13 : 49 : 12 : 34 : 56
EUI-64	02 : 13 : 49 : FF : FE : 12 : 34 : 56

Identity Association

An Identity Association (IA) is a collection of addresses assigned to a DHCP client, through which the server and client can manage a set of related IP addresses. Each IA must be associated with exactly one interface. The DHCP client uses the IA assigned to an interface to obtain configuration from a DHCP server for that interface. Each IA consists of a unique IAID and associated IP information.

The IA type is the type of address in the IA. Each IA holds one type of address. IA_NA means an identity association for non-temporary addresses and IA_TA is an identity association for temporary addresses. An IA_NA option contains the T1 and T2 fields, but an IA_TA option does not. The DHCPv6 server uses T1 and T2 to control the time at which the client contacts with the server to extend the lifetimes on any addresses in the IA_NA before the lifetimes expire. After T1, the client sends the server (S1) (from which the addresses in the IA_NA were obtained) a Renew message. If

the time T2 is reached and the server does not respond, the client sends a Rebind message to any available server (S2). For an IA_TA, the client may send a Renew or Rebind message at the client's discretion.

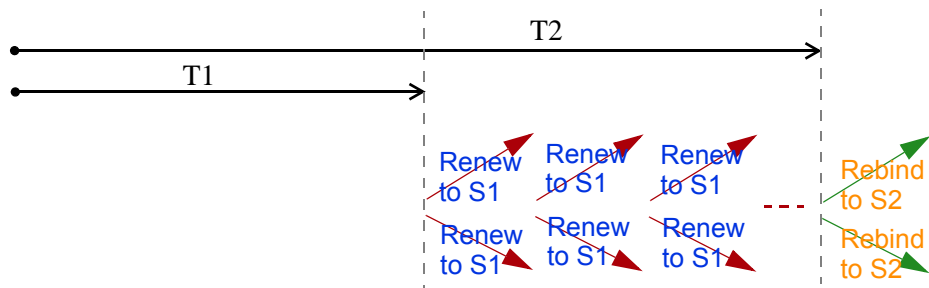

DHCP Relay Agent

A DHCP relay agent is on the same network as the DHCP clients and helps forward messages between the DHCP server and clients. When a client cannot use its link-local address and a well-known multicast address to locate a DHCP server on its network, it then needs a DHCP relay agent to send a message to a DHCP server that is not attached to the same network.

The DHCP relay agent can add the remote identification (remote-ID) option and the interface-ID option to the Relay-Forward DHCPv6 messages. The remote-ID option carries a user-defined string, such as the system name. The interface-ID option provides slot number, port information and the VLAN ID to the DHCPv6 server. The remote-ID option (if any) is stripped from the Relay-Reply messages before the relay agent sends the packets to the clients. The DHCP server copies the interface-ID option from the Relay-Forward message into the Relay-Reply message and sends it to the relay agent. The interface-ID should not change even after the relay agent restarts.

Prefix Delegation

Prefix delegation enables an IPv6 router to use the IPv6 prefix (network address) received from the ISP (or a connected uplink router) for its LAN. The Device uses the received IPv6 prefix (for example, 2001:db2::/48) to generate its LAN IP address. Through sending Router Advertisements (RAs) regularly by multicast, the Device passes the IPv6 prefix information to its LAN hosts. The hosts then can use the prefix to generate their IPv6 addresses.

ICMPv6

Internet Control Message Protocol for IPv6 (ICMPv6 or ICMP for IPv6) is defined in RFC 4443. ICMPv6 has a preceding Next Header value of 58, which is different from the value used to identify ICMP for IPv4. ICMPv6 is an integral part of IPv6. IPv6 nodes use ICMPv6 to report errors encountered in packet processing and perform other diagnostic functions, such as "ping".

Neighbor Discovery Protocol (NDP)

The Neighbor Discovery Protocol (NDP) is a protocol used to discover other IPv6 devices and track neighbor's reachability in a network. An IPv6 device uses the following ICMPv6 messages types:

- Neighbor solicitation: A request from a host to determine a neighbor's link-layer address (MAC address) and detect if the neighbor is still reachable. A neighbor being "reachable" means it responds to a neighbor solicitation message (from the host) with a neighbor advertisement message.

- Neighbor advertisement: A response from a node to announce its link-layer address.
- Router solicitation: A request from a host to locate a router that can act as the default router and forward packets.
- Router advertisement: A response to a router solicitation or a periodical multicast advertisement from a router to advertise its presence and other parameters.

IPv6 Cache

An IPv6 host is required to have a neighbor cache, destination cache, prefix list and default router list. The Device maintains and updates its IPv6 caches constantly using the information from response messages. In IPv6, the Device configures a link-local address automatically, and then sends a neighbor solicitation message to check if the address is unique. If there is an address to be resolved or verified, the Device also sends out a neighbor solicitation message. When the Device receives a neighbor advertisement in response, it stores the neighbor's link-layer address in the neighbor cache. When the Device uses a router solicitation message to query for a router and receives a router advertisement message, it adds the router's information to the neighbor cache, prefix list and destination cache. The Device creates an entry in the default router list cache if the router can be used as a default router.

When the Device needs to send a packet, it first consults the destination cache to determine the next hop. If there is no matching entry in the destination cache, the Device uses the prefix list to determine whether the destination address is on-link and can be reached directly without passing through a router. If the address is un-link, the address is considered as the next hop. Otherwise, the Device determines the next-hop from the default router list or routing table. Once the next hop IP address is known, the Device looks into the neighbor cache to get the link-layer address and sends the packet when the neighbor is reachable. If the Device cannot find an entry in the neighbor cache or the state for the neighbor is not reachable, it starts the address resolution process. This helps reduce the number of IPv6 solicitation and advertisement messages.

Multicast Listener Discovery

The Multicast Listener Discovery (MLD) protocol (defined in RFC 2710) is derived from IPv4's Internet Group Management Protocol version 2 (IGMPv2). MLD uses ICMPv6 message types, rather than IGMP message types. MLDv1 is equivalent to IGMPv2 and MLDv2 is equivalent to IGMPv3.

MLD allows an IPv6 switch or router to discover the presence of MLD listeners who wish to receive multicast packets and the IP addresses of multicast groups the hosts want to join on its network.

MLD snooping and MLD proxy are analogous to IGMP snooping and IGMP proxy in IPv4.

MLD filtering controls which multicast groups a port can join.

MLD Messages

A multicast router or switch periodically sends general queries to MLD hosts to update the multicast forwarding table. When an MLD host wants to join a multicast group, it sends an MLD Report message for that address.

An MLD Done message is equivalent to an IGMP Leave message. When an MLD host wants to leave a multicast group, it can send a Done message to the router or switch. The router or switch then sends a group-specific query to the port on which the Done message is received to determine if other devices connected to this port should remain in the group.

Example - Enabling IPv6 on Windows XP/2003/Vista

By default, Windows XP and Windows 2003 support IPv6. This example shows you how to use the `ipv6 install` command on Windows XP/2003 to enable IPv6. This also displays how to use the `ipconfig` command to see auto-generated IP addresses.

```
C:\>ipv6 install
Installing...
Succeeded.

C:\>ipconfig

Windows IP Configuration

Ethernet adapter Local Area Connection:

    Connection-specific DNS Suffix  . :
    IP Address. . . . . : 10.1.1.46
    Subnet Mask . . . . . : 255.255.255.0
    IP Address. . . . . : fe80::2d0:59ff:feb8:103c%4
    Default Gateway . . . . . : 10.1.1.254
```

IPv6 is installed and enabled by default in Windows Vista. Use the `ipconfig` command to check your automatic configured IPv6 address as well. You should see at least one IPv6 address available for the interface on your computer.

Example - Enabling DHCPv6 on Windows XP

Windows XP does not support DHCPv6. If your network uses DHCPv6 for IP address assignment, you have to additionally install a DHCPv6 client software on your Windows XP. (Note: If you use static IP addresses or Router Advertisement for IPv6 address assignment in your network, ignore this section.)

This example uses Dibbler as the DHCPv6 client. To enable DHCPv6 client on your computer:

- 1 Install Dibbler and select the DHCPv6 client option on your computer.
- 2 After the installation is complete, select **Start > All Programs > Dibbler-DHCPv6 > Client Install as service**.
- 3 Select **Start > Control Panel > Administrative Tools > Services**.
- 4 Double click **Dibbler - a DHCPv6 client**.

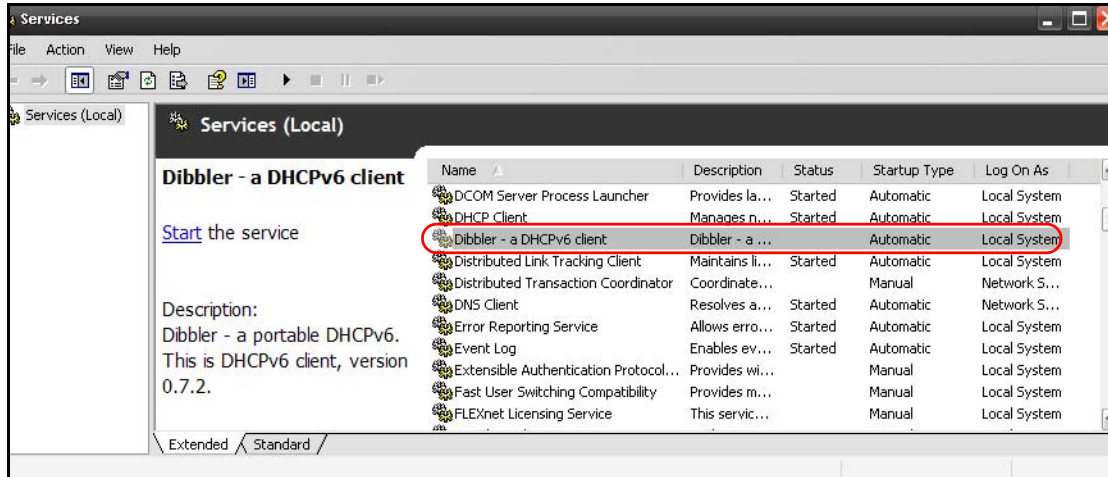

- 5 Click **Start** and then **OK**.

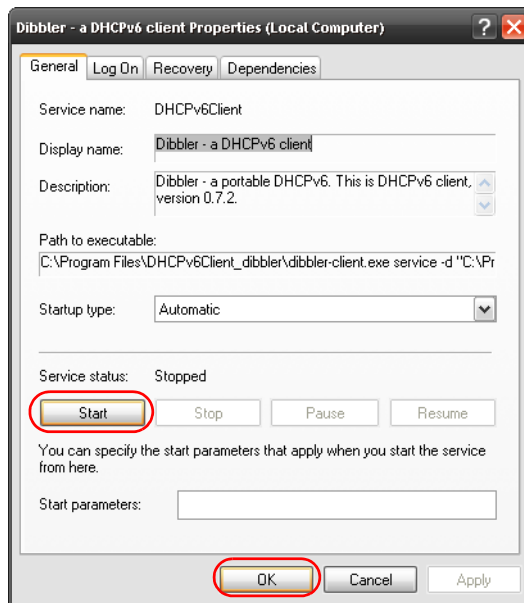

- 6 Now your computer can obtain an IPv6 address from a DHCPv6 server.

Example - Enabling IPv6 on Windows 7

Windows 7 supports IPv6 by default. DHCPv6 is also enabled when you enable IPv6 on a Windows 7 computer.

To enable IPv6 in Windows 7:

- 1 Select **Control Panel > Network and Sharing Center > Local Area Connection**.
- 2 Select the **Internet Protocol Version 6 (TCP/IPv6)** checkbox to enable it.
- 3 Click **OK** to save the change.

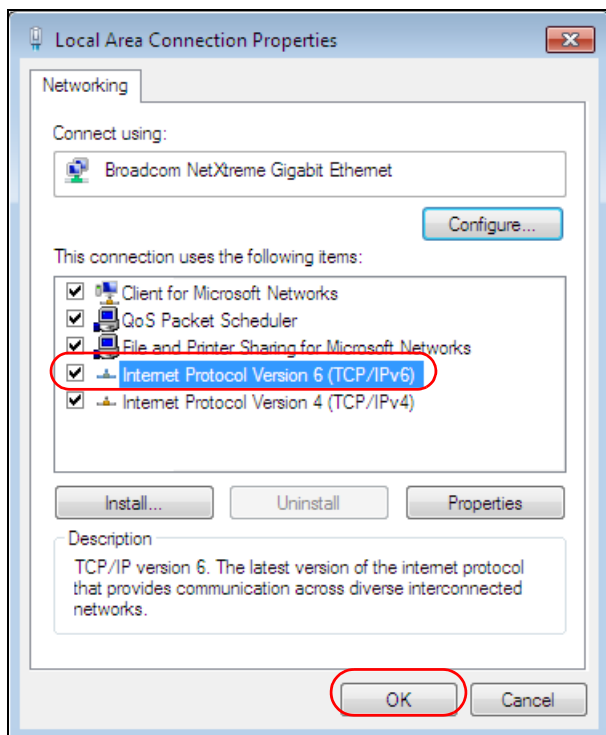

- 4 Click **Close** to exit the **Local Area Connection Status** screen.
- 5 Select **Start > All Programs > Accessories > Command Prompt**.
- 6 Use the `ipconfig` command to check your dynamic IPv6 address. This example shows a global address (2001:b021:2d::1000) obtained from a DHCP server.

```

C:\>ipconfig

Windows IP Configuration

Ethernet adapter Local Area Connection:

    Connection-specific DNS Suffix  . :
    IPv6 Address. . . . . : 2001:b021:2d::1000
    Link-local IPv6 Address . . . . . : fe80::25d8:dcab:c80a:5189%11
    IPv4 Address. . . . . : 172.16.100.61
    Subnet Mask . . . . . : 255.255.255.0
    Default Gateway . . . . . : fe80::213:49ff:feaa:7125%11
                                172.16.100.254
  
```

Services

The following table lists some commonly-used services and their associated protocols and port numbers.

- **Name:** This is a short, descriptive name for the service. You can use this one or create a different one, if you like.
- **Protocol:** This is the type of IP protocol used by the service. If this is **TCP/UDP**, then the service uses the same port number with TCP and UDP. If this is **USER-DEFINED**, the **Port(s)** is the IP protocol number, not the port number.
- **Port(s):** This value depends on the **Protocol**.
 - If the **Protocol** is **TCP, UDP, or TCP/UDP**, this is the IP port number.
 - If the **Protocol** is **USER**, this is the IP protocol number.
- **Description:** This is a brief explanation of the applications that use this service or the situations in which this service is used.

Table 134 Examples of Services

NAME	PROTOCOL	PORT(S)	DESCRIPTION
AH (IPSEC_TUNNEL)	User-Defined	51	The IPSEC AH (Authentication Header) tunneling protocol uses this service.
AIM	TCP	5190	AOL's Internet Messenger service.
AUTH	TCP	113	Authentication protocol used by some servers.
BGP	TCP	179	Border Gateway Protocol.
BOOTP_CLIENT	UDP	68	DHCP Client.
BOOTP_SERVER	UDP	67	DHCP Server.
CU-SEEME	TCP/UDP TCP/UDP	7648 24032	A popular videoconferencing solution from White Pines Software.
DNS	TCP/UDP	53	Domain Name Server, a service that matches web names (for instance www.zyxel.com) to IP numbers.
ESP (IPSEC_TUNNEL)	User-Defined	50	The IPSEC ESP (Encapsulation Security Protocol) tunneling protocol uses this service.
FINGER	TCP	79	Finger is a UNIX or Internet related command that can be used to find out if a user is logged on.
FTP	TCP TCP	20 21	File Transfer Protocol, a program to enable fast transfer of files, including large files that may not be possible by e-mail.
H.323	TCP	1720	NetMeeting uses this protocol.
HTTP	TCP	80	Hyper Text Transfer Protocol - a client/server protocol for the world wide web.
HTTPS	TCP	443	HTTPS is a secured http session often used in e-commerce.
ICMP	User-Defined	1	Internet Control Message Protocol is often used for diagnostic purposes.
ICQ	UDP	4000	This is a popular Internet chat program.
IGMP (MULTICAST)	User-Defined	2	Internet Group Multicast Protocol is used when sending packets to a specific group of hosts.
IKE	UDP	500	The Internet Key Exchange algorithm is used for key distribution and management.
IMAP4	TCP	143	The Internet Message Access Protocol is used for e-mail.
IMAP4S	TCP	993	This is a more secure version of IMAP4 that runs over SSL.
IRC	TCP/UDP	6667	This is another popular Internet chat program.
MSN Messenger	TCP	1863	Microsoft Networks' messenger service uses this protocol.
NetBIOS	TCP/UDP TCP/UDP TCP/UDP TCP/UDP	137 138 139 445	The Network Basic Input/Output System is used for communication between computers in a LAN.
NEW-ICQ	TCP	5190	An Internet chat program.
NEWS	TCP	144	A protocol for news groups.

Table 134 Examples of Services (continued)

NAME	PROTOCOL	PORT(S)	DESCRIPTION
NFS	UDP	2049	Network File System - NFS is a client/server distributed file service that provides transparent file sharing for network environments.
NNTP	TCP	119	Network News Transport Protocol is the delivery mechanism for the USENET newsgroup service.
PING	User-Defined	1	Packet INternet Groper is a protocol that sends out ICMP echo requests to test whether or not a remote host is reachable.
POP3	TCP	110	Post Office Protocol version 3 lets a client computer get e-mail from a POP3 server through a temporary connection (TCP/IP or other).
POP3S	TCP	995	This is a more secure version of POP3 that runs over SSL.
PPTP	TCP	1723	Point-to-Point Tunneling Protocol enables secure transfer of data over public networks. This is the control channel.
PPTP_TUNNEL (GRE)	User-Defined	47	PPTP (Point-to-Point Tunneling Protocol) enables secure transfer of data over public networks. This is the data channel.
RCMD	TCP	512	Remote Command Service.
REAL_AUDIO	TCP	7070	A streaming audio service that enables real time sound over the web.
REXEC	TCP	514	Remote Execution Daemon.
RLOGIN	TCP	513	Remote Login.
ROADRUNNER	TCP/UDP	1026	This is an ISP that provides services mainly for cable modems.
RTELNET	TCP	107	Remote Telnet.
RTSP	TCP/UDP	554	The Real Time Streaming (media control) Protocol (RTSP) is a remote control for multimedia on the Internet.
SFTP	TCP	115	The Simple File Transfer Protocol is an old way of transferring files between computers.
SMTP	TCP	25	Simple Mail Transfer Protocol is the message-exchange standard for the Internet. SMTP enables you to move messages from one e-mail server to another.
SMTPS	TCP	465	This is a more secure version of SMTP that runs over SSL.
SNMP	TCP/UDP	161	Simple Network Management Program.
SNMP-TRAPS	TCP/UDP	162	Traps for use with the SNMP (RFC:1215).
SQL-NET	TCP	1521	Structured Query Language is an interface to access data on many different types of database systems, including mainframes, midrange systems, UNIX systems and network servers.
SSDP	UDP	1900	The Simple Service Discovery Protocol supports Universal Plug-and-Play (UPnP).
SSH	TCP/UDP	22	Secure Shell Remote Login Program.
STRM WORKS	UDP	1558	Stream Works Protocol.

Table 134 Examples of Services (continued)

NAME	PROTOCOL	PORT(S)	DESCRIPTION
SYSLOG	UDP	514	Syslog allows you to send system logs to a UNIX server.
TACACS	UDP	49	Login Host Protocol used for (Terminal Access Controller Access Control System).
TELNET	TCP	23	Telnet is the login and terminal emulation protocol common on the Internet and in UNIX environments. It operates over TCP/IP networks. Its primary function is to allow users to log into remote host systems.
VDOLIVE	TCP UDP	7000 user- defined	A videoconferencing solution. The UDP port number is specified in the application.

Legal Information

Copyright

Copyright © 2015 by ZyxEL Communications Corporation.

The contents of this publication may not be reproduced in any part or as a whole, transcribed, stored in a retrieval system, translated into any language, or transmitted in any form or by any means, electronic, mechanical, magnetic, optical, chemical, photocopying, manual, or otherwise, without the prior written permission of ZyxEL Communications Corporation.

Published by ZyxEL Communications Corporation. All rights reserved.

Disclaimer

ZyxEL does not assume any liability arising out of the application or use of any products, or software described herein. Neither does it convey any license under its patent rights nor the patent rights of others. ZyxEL further reserves the right to make changes in any products described herein without notice. This publication is subject to change without notice.

Regulatory Notice and Statement

UNITED STATE AMERICA



The following information applies if you use the product within USA area.

FCC EMC Statement

- The device complies with Part 15 of FCC rules. Operation is subject to the following two conditions:
 - (1) This device may not cause harmful interference, and
 - (2) this device must accept any interference received, including interference that may cause undesired operation.
- Changes or modifications not expressly approved by the party responsible for compliance could void the user's authority to operate the equipment.
- This product has been tested and complies with the specifications for a Class B digital device, pursuant to Part 15 of the FCC Rules. These limits are designed to provide reasonable protection against harmful interference in a residential installation. This equipment generates, uses, and can radiate radio frequency energy and, if not installed and used according to the instructions, may cause harmful interference to radio communications. However, there is no guarantee that interference will not occur in a particular installation.
- If this equipment does cause harmful interference to radio or television reception, which is found by turning the equipment off and on, the user is encouraged to try to correct the interference by one or more of the following measures:
 - Reorient or relocate the receiving antenna
 - Increase the separation between the equipment or devices
 - Connect the equipment to an outlet other than the receiver's
 - Consult a dealer or an experienced radio/TV technician for assistance

FCC Radiation Exposure Statement

This equipment complies with FCC RF radiation exposure limits set forth for an uncontrolled environment.

This transmitter must be at least 20 cm from the user and must not be co-located or operating in conjunction with any other antenna or transmitter.

CANADA

The following information applies if you use the product within Canada area

Industry Canada ICES statement

CAN ICES-3 (B)/NMB-3(B)

Industry Canada RSS-GEN & RSS-247 statement

- This device complies with Industry Canada's licence-exempt RSSs. Operation is subject to the following two conditions:(1) This device may not cause interference; and (2) This device must accept any interference, including interference that may cause undesired operation of the device.

- This radio transmitter has been approved by Industry Canada to operate with the antenna types listed below with the maximum permissible gain and required antenna impedance for each antenna type indicated. Antenna types not included in this list, having a gain greater than the maximum gain indicated for that type, are strictly prohibited for use with this device.
- If you use the produce with 5G wireless function, the following attention shall be paid that,
 - (i) the device for operation in the band 5150-5250 MHz is only for indoor use to reduce the potential for harmful interference to co-channel mobile satellite systems;
- Le présent appareil est conforme aux CNR d'Industrie Canada applicables aux appareils radio exempts de licence. L'exploitation est autorisée aux deux conditions suivantes : (1) l'appareil ne doit pas produire de brouillage; (2) l'utilisateur de l'appareil doit accepter tout brouillage radioélectrique subi, même si le brouillage est susceptible d'en compromettre le fonctionnement.
- Le présent émetteur radio de modèle s'il fait partie du matériel de catégorie I a été approuvé par Industrie Canada pour fonctionner avec les types d'antenne énumérés ci-dessous et ayant un gain admissible maximal et l'impédance requise pour chaque type d'antenne. Les types d'antenne non inclus dans cette liste, ou dont le gain est supérieur au gain maximal indiqué, sont strictement interdits pour l'exploitation de l'émetteur.
- Si vous utilisez le produit avec 5G sans fil fonction, suivant l'attention doit être versée que,
 - (i) les dispositifs fonctionnant dans la bande 5150-5250 MHz sont réservés uniquement pour une utilisation à l'intérieur afin de réduire les risques de brouillage préjudiciable aux systèmes de satellites mobiles utilisant les mêmes canaux;

Industry Canada Radiation Exposure Statement

This equipment complies with IC radiation exposure limits set forth for an uncontrolled environment. This equipment should be installed and operated with a minimum distance of 20 cm between the radiator and your body.

Déclaration d'exposition aux radiations:

Cet équipement est conforme aux limites d'exposition aux rayonnements IC établies pour un environnement non contrôlé. Cet équipement doit être installé et utilisé avec un minimum de 20 cm de distance entre la source de rayonnement et votre corps.

EUROPEAN UNION



The following information applies if you use the product within the European Union.

Declaration of Conformity with Regard to EU Directive 1999/5/EC (R&TTE Directive)

Compliance information for 2.4GHz and/or 5GHz wireless products relevant to the EU and other Countries following the EU Directive 1999/5/EC (R&TTE)

Български (Bulgarian)	С настоящото ZyXEL декларира, че това оборудване е в съответствие със съществените изисквания и другите приложими разпоредбите на Директива 1999/5/EC.
Español (Spanish)	Por medio de la presente ZyXEL declara que el equipo cumple con los requisitos esenciales y cualesquiera otras disposiciones aplicables o exigibles de la Directiva 1999/5/CE.
Čeština (Czech)	ZyXEL tímto prohlašuje, že tento zařízení je ve shodě se základními požadavky a dalšími příslušnými ustanoveními směrnice 1999/5/EC.
Dansk (Danish)	Undertegnede ZyXEL erklærer herved, at følgende udstyr overholder de væsentlige krav og øvrige relevante krav i direktiv 1999/5/EF.
Deutsch (German)	Hiermit erklärt ZyXEL, dass sich das Gerät Ausstattung in Übereinstimmung mit den grundlegenden Anforderungen und den übrigen einschlägigen Bestimmungen der Richtlinie 1999/5/EU befindet.
Eesti keel (Estonian)	Käesolevaga kinnitab ZyXEL seadme seadmed vastavust direktiivi 1999/5/EÜ põhinõuetele ja nimetatud direktiivist tulenevatele teistele asjakohastele sätetele.
Ελληνικά (Greek)	ΜΕ ΤΗΝ ΠΑΡΟΥΣΑ ΖΥΧΕΛ ΔΗΛΩΝΕΙ ΟΤΙ ΕΞΟΠΛΙΣΜΟΣ ΣΥΜΜΟΡΦΩΝΕΤΑΙ ΠΡΟΣ ΤΙΣ ΟΥΣΙΩΔΕΙΣ ΑΠΑΙΤΗΣΕΙΣ ΚΑΙ ΤΙΣ ΛΟΙΠΕΣ ΣΧΕΤΙΚΕΣ ΔΙΑΤΑΞΕΙΣ ΤΗΣ ΟΔΗΓΙΑΣ 1999/5/ΕΚ.
English	Hereby, ZyXEL declares that this equipment is in compliance with the essential requirements and other relevant provisions of Directive 1999/5/EC.
Français (French)	Par la présente ZyXEL déclare que l'appareil équipements est conforme aux exigences essentielles et aux autres dispositions pertinentes de la directive 1999/5/EC.
Hrvatski (Croatian)	ZyXEL ovime izjavljuje da je radijska oprema tipa u skladu s Direktivom 1999/5/EC.
Íslenska (Icelandic)	Hér með lýsir, ZyXEL því yfir að þessi búnaður er í samræmi við grunnkröfur og önnur viðeigandi ákvæði tilskipunar 1999/5/EC.
Italiano (Italian)	Con la presente ZyXEL dichiara che questo attrezzatura è conforme ai requisiti essenziali ed alle altre disposizioni pertinenti stabilite dalla direttiva 1999/5/CE.
Latviešu valoda (Latvian)	Ar šo ZyXEL deklarē, ka iekārtas atbilst Direktīvas 1999/5/EK būtiskajām prasībām un citiem ar to saistītajiem noteikumiem.
Lietuvių kalba (Lithuanian)	Šiuo ZyXEL deklaruoja, kad šis įranga atitinka esminius reikalavimus ir kitas 1999/5/EB Direktyvos nuostatas.

Magyar (Hungarian)	Alulírott, ZyXEL nyilatkozom, hogy a berendezés megfelel a vonatkozó alapvető követelményeknek és az 1999/5/EK irányelv egyéb előírásainak.
Malti (Maltese)	Hawnhekk, ZyXEL, jiddikjara li dan taghmir jikkonforma mal-htigijiet essenzjali u ma provvedimenti oħrajn relevanti li hemm fid-Dirrettiva 1999/5/EC.
Nederlands (Dutch)	Hierbij verklaart ZyXEL dat het toestel uitrusting in overeenstemming is met de essentiële eisen en de andere relevante bepalingen van richtlijn 1999/5/EC.
Polski (Polish)	Niniejszym ZyXEL oświadcza, że sprzęt jest zgodny z zasadniczymi wymogami oraz pozostałymi stosownymi postanowieniami Dyrektywy 1999/5/EC.
Português (Portuguese)	ZyXEL declara que este equipamento está conforme com os requisitos essenciais e outras disposições da Directiva 1999/5/EC.
Română (Romanian)	Prin prezenta, ZyXEL declară că acest echipament este în conformitate cu cerințele esențiale și alte prevederi relevante ale Directivei 1999/5/EC.
Slovenčina (Slovak)	ZyXEL týmto vyhlasuje, že zariadenia spĺňa základné požiadavky a všetky príslušné ustanovenia Smernice 1999/5/EC.
Slovenščina (Slovene)	ZyXEL izjavlja, da je ta oprema v skladu z bistvenimi zahtevami in ostalimi relevantnimi določili direktive 1999/5/EC.
Suomi (Finnish)	ZyXEL vakuuttaa täten että laitteet tyyppinen laite on direktiivin 1999/5/EY oleellisten vaatimusten ja sitä koskevien direktiivin muiden ehtojen mukainen.
Svenska (Swedish)	Härmed intygar ZyXEL att denna utrustning står i överensstämmelse med de väsentliga egenskapskrav och övriga relevanta bestämmelser som framgår av direktiv 1999/5/EC.
Norsk (Norwegian)	Erklærer herved ZyXEL at dette utstyret er i samsvar med de grunnleggende kravene og andre relevante bestemmelser i direktiv 1999/5/EF.

National Restrictions

This product may be used in all EU countries (and other countries following the EU Directive 1999/5/EC) without any limitation except for the countries mentioned below:

Ce produit peut être utilisé dans tous les pays de l'UE (et dans tous les pays ayant transposés la directive 1999/5/CE) sans aucune limitation, excepté pour les pays mentionnés ci-dessous:

Questo prodotto è utilizzabile in tutte i paesi EU (ed in tutti gli altri paesi che seguono le direttiva 1999/5/EC) senza nessuna limitazione, eccetto per i paesi menzionati di seguito:

Das Produkt kann in allen EU Staaten ohne Einschränkungen eingesetzt werden (sowie in anderen Staaten die der Richtlinie 1999/5/CE folgen) mit Ausnahme der folgenden aufgeführten Staaten:

In the majority of the EU and other European countries, the 2.4GHz and 5GHz bands have been made available for the use of wireless local area networks (LANs). Later in this document you will find an overview of countries in which additional restrictions or requirements or both are applicable.

The requirements for any country may evolve. ZyXEL recommends that you check with the local authorities for the latest status of their national regulations for both the 2.4GHz and 5GHz wireless LANs.

The following countries have restrictions and/or requirements in addition to those given in the table labeled "Overview of Regulatory Requirements for Wireless LANs":

Belgium

The Belgian Institute for Postal Services and Telecommunications (BIPT) must be notified of any outdoor wireless link having a range exceeding 300 meters. Please check <http://www.bipt.be> for more details.

Draadloze verbindingen voor buitengebruik en met een reikwijdte van meer dan 300 meter dienen aangemeld te worden bij het Belgisch Instituut voor postdiensten en telecommunicatie (BIPT). Zie <http://www.bipt.be> voor meer gegevens.

Les liaisons sans fil pour une utilisation en extérieur d'une distance supérieure à 300 mètres doivent être notifiées à l'Institut Belge des services Postaux et des Télécommunications (IBPT). Visitez <http://www.ibpt.be> pour de plus amples détails.

Denmark

In Denmark, the band 5150 - 5350 MHz is also allowed for outdoor usage.

I Danmark må frekvensbåndet 5150 - 5350 også anvendes udendørs.

Italy

This product meets the National Radio Interface and the requirements specified in the National Frequency Allocation Table for Italy. Unless this wireless LAN product is operating within the boundaries of the owner's property, its use requires a "general authorization." Please check <http://www.sviluppoeconomico.gov.it/> for more details.

Questo prodotto è conforme alla specifiche di Interfaccia Radio Nazionali e rispetta il Piano Nazionale di ripartizione delle frequenze in Italia. Se non viene installato all'interno del proprio fondo, l'utilizzo di prodotti Wireless LAN richiede una "Autorizzazione Generale". Consultare <http://www.sviluppoeconomico.gov.it/> per maggiori dettagli.

Latvia

The outdoor usage of the 2.4 GHz band requires an authorization from the Electronic Communications Office. Please check <http://www.esd.lv> for more details.

2.4 GHz frekvenču joslas izmantošanai ārpus telpām nepieciešama atļauja no Elektronisko sakaru direkcijas. Vairāk informācijas: <http://www.esd.lv>.

Notes:

1. Although Norway, Switzerland and Liechtenstein are not EU member states, the EU Directive 1999/5/EC has also been implemented in those countries.
2. The regulatory limits for maximum output power are specified in EIRP. The EIRP level (in dBm) of a device can be calculated by adding the gain of the antenna used (specified in dBi) to the output power available at the connector (specified in dBm).

List of national codes

COUNTRY	ISO 3166 2 LETTER CODE	COUNTRY	ISO 3166 2 LETTER CODE
Austria	AT	Liechtenstein	LI
Belgium	BE	Lithuania	LT
Bulgaria	BG	Luxembourg	LU
Croatia	HR	Malta	MT
Cyprus	CY	Netherlands	NL
Czech Republic	CZ	Norway	NO
Denmark	DK	Poland	PL
Estonia	EE	Portugal	PT
Finland	FI	Romania	RO
France	FR	Serbia	RS
Germany	DE	Slovakia	SK
Greece	GR	Slovenia	SI
Hungary	HU	Spain	ES
Iceland	IS	Switzerland	CH
Ireland	IE	Sweden	SE
Italy	IT	Turkey	TR
Latvia	LV	United Kingdom	GB

Safety Warnings

- DO NOT use this product near water, for example, in a wet basement or near a swimming pool.
- DO NOT expose your device to dampness, dust or corrosive liquids.
- DO NOT store things on the device.
- DO NOT install, use, or service this device during a thunderstorm. There is a remote risk of electric shock from lightning.
- Connect ONLY suitable accessories to the device.
- DO NOT open the device or unit. Opening or removing covers can expose you to dangerous high voltage points or other risks. ONLY qualified service personnel should service or disassemble this device. Please contact your vendor for further information.
- Make sure to connect the cables to the correct ports.
- Place connecting cables carefully so that no one will step on them or stumble over them.
- Always disconnect all cables from this device before servicing or disassembling.
- Use ONLY an appropriate power adaptor or cord for your device. Connect it to the right supply voltage (for example, 110V AC in North America or 230V AC in Europe).
- DO NOT remove the plug and connect it to a power outlet by itself; always attach the plug to the power adaptor first before connecting it to a power outlet.
- DO NOT allow anything to rest on the power adaptor or cord and do NOT place the product where anyone can walk on the power adaptor or cord.
- DO NOT use the device if the power adaptor or cord is damaged as it might cause electrocution.
- If the power adaptor or cord is damaged, remove it from the device and the power source.
- DO NOT attempt to repair the power adaptor or cord. Contact your local vendor to order a new one.
- DO NOT use the device outside, and make sure all the connections are indoors. There is a remote risk of electric shock from lightning.
- CAUTION: RISK OF EXPLOSION IF BATTERY (on the motherboard) IS REPLACED BY AN INCORRECT TYPE. DISPOSE OF USED BATTERIES ACCORDING TO THE INSTRUCTIONS. Dispose them at the applicable collection point for the recycling of electrical and electronic equipment. For detailed information about recycling of this product, please contact your local city office, your household waste disposal service or the store where you purchased the product.
- DO NOT obstruct the device ventilation slots, as insufficient airflow may harm your device.

The following warning statements apply, where the disconnect device is not incorporated in the equipment or where the plug on the power supply cord is intended to serve as the disconnect device,

- For PERMANENTLY CONNECTED EQUIPMENT, a readily accessible disconnect device shall be incorporated external to the equipment;
- For PLUGGABLE EQUIPMENT, the socket-outlet shall be installed near the equipment and shall be easily accessible.

Environment Statement

ErP (Energy-related Products)

ZyXEL products put on the EU market in compliance with the requirement of the European Parliament and the Council published Directive 2009/125/EC establishing a framework for the setting of ecodesign requirements for energy-related products (recast), so called as "ErP Directive (Energy-related Products directive) as well as ecodesign requirement laid down in applicable implementing measures, power consumption has satisfied regulation requirements which are:

Network standby power consumption < 12W, and/or

Off mode power consumption < 0.5W, and/or

Standby mode power consumption < 0.5W.

Wireless setting, please refer to "Wireless" chapter for more detail.

European Union - Disposal and Recycling Information

WEEE Directive

The symbol below means that according to local regulations your product and/or its battery shall be disposed of separately from domestic waste. If this product is end of life, take it to a recycling station designated by local authorities. At the time of disposal, the separate collection of your product and/or its battery will help save natural resources and ensure that the environment is sustainable development.

Die folgende Symbol bedeutet, dass Ihr Produkt und/oder seine Batterie gemäß den örtlichen Bestimmungen getrennt vom Hausmüll entsorgt werden muss. Wenden Sie sich an eine Recyclingstation, wenn dieses Produkt das Ende seiner Lebensdauer erreicht hat. Zum Zeitpunkt der Entsorgung wird die getrennte Sammlung von Produkt und/oder seiner Batterie dazu beitragen, natürliche Ressourcen zu sparen und die Umwelt und die menschliche Gesundheit zu schützen.

El símbolo de abajo indica que según las regulaciones locales, su producto y/o su batería deberán depositarse como basura separada de la doméstica. Cuando este producto alcance el final de su vida útil, llévelo a un punto limpio. Cuando llegue el momento de desechar el producto, la recogida por separado éste y/o su batería ayudará a salvar los recursos naturales y a proteger la salud humana y medioambiental.

Le symbole ci-dessous signifie que selon les réglementations locales votre produit et/ou sa batterie doivent être éliminés séparément des ordures ménagères. Lorsque ce produit atteint sa fin de vie, amenez-le à un centre de recyclage. Au moment de la mise au rebut, la collecte séparée de votre produit et/ou de sa batterie aidera à économiser les ressources naturelles et protéger l'environnement et la santé humaine.

Il simbolo sotto significa che secondo i regolamenti locali il vostro prodotto e/o batteria deve essere smaltito separatamente dai rifiuti domestici. Quando questo prodotto raggiunge la fine della vita di servizio portarlo a una stazione di riciclaggio. Al momento dello smaltimento, la raccolta separata del vostro prodotto e/o della sua batteria aiuta a risparmiare risorse naturali e a proteggere l'ambiente e la salute umana.

Symbolen innebär att enligt lokal lagstiftning ska produkten och/eller dess batteri kastas separat från hushållsavfallet. När den här produkten når slutet av sin livslängd ska du ta den till en återvinningsstation. Vid tiden för kasseringen bidrar du till en bättre miljö och mänsklig hälsa genom att göra dig av med den på ett återvinningsställe.



Environmental Product Declaration

Български (Bulgarian)	Čeština (Czech)	Dansk (Danish)	Deutsch (German)
<p>Екологична продуктова декларация</p> <p>RoHS Директива 2011/65/EC WEEE Директива 2012/19/EC PPW Директива 94/62/EC REACH REGULATION (EC) n° 1907/2006 EoP Директива 2009/125/EC</p> <p>Име/ титла : Richard Hsu / Quality Management Division Senior Manager Подпис : Дата (dd/mm/yyyy): 01/10/2014</p>  	<p>Environmentální prohlášení o produktu</p> <p>RoHS Směrnice 2011/65/EU WEEE Směrnice 2012/19/EU PPW Směrnice 94/62/EC REACH Nařízení (ES) č. 1907/2006 EoP Směrnice 2009/125/ES</p> <p>Jméno/ titul : Richard Hsu / Quality Management Division Senior Manager Podpis : Datum (dd/mm/yyyy): 01/10/2014</p>  	<p>Miljøvaredeklaration</p> <p>RoHS Direktiv 2011/65/EU WEEE Direktiv 2012/19/EC PPW Direktiv 94/62/EF REACH Forordning (EF) nr. 1907/2006 EoP Direktiv 2009/125/EF</p> <p>Navn/ titel : Richard Hsu / Quality Management Division Senior Manager Underskrift : Dato (dd/mm/åååå): 01/10/2014</p>  	<p>Produkt-Umweltdeklaration</p> <p>RoHS Richtlinie 2011/65/EU WEEE Richtlinie 2012/19/EC PPW Richtlinie 94/62/EG REACH VERORDNUNG (EG) Nr. 1907/2006 EoP Richtlinie 2009/125/EG</p> <p>Name/ titel : Richard Hsu / Quality Management Division Senior Manager Unterschrift : Datum (dd/mm/jj): 2014/10/01</p>  
<p>Toote keskkonnadeklaratsioon</p> <p>RoHS Direktiiv 2011/65/EU WEEE Direktiiv 2012/19/EC PPW Direktiiv 94/62/EÜ REACH Määrus (EÜ) nr. 1907/2006 EoP Direktiiv 2009/125/EÜ</p> <p>Nimi/ amet : Richard Hsu / Quality Management Division Senior Manager Allkiri : Kuupäev (pp/kk/aaaa): 01/10/2014</p>  	<p>Environmental product declaration</p> <p>RoHS Directive 2011/65/EU WEEE Directive 2012/19/EC PPW Directive 94/62/EC REACH Regulation (EC) No. 1907/2006 EoP Directive 2009/125/EC</p> <p>Name/ title : Richard Hsu / Quality Management Division Senior Manager Signature : Date (dd/mm/yyyy): 01/10/2014</p>  	<p>Declaraciones Ambientales de Producto</p> <p>RoHS Directiva 2011/65/EU WEEE Directiva 2012/19/EC PPW Directiva 94/62/CE REACH Reglamento (CE) n° 1907/2006 EoP Directiva 2009/125/CE</p> <p>Nombre/ título : Richard Hsu / Quality Management Division Senior Manager Firma : Fecha (dd/mm/aaaa): 2014/10/01</p>  	<p>Profil environnemental de produit</p> <p>RoHS Directive 2011/65/UE WEEE Directive 2012/19/UE PPW Directive 94/62/CE REACH RÈGLEMENT (CE) n° 1907/2006 EoP Directive 2009/125/CE</p> <p>Nom/ titre : Richard Hsu / Quality Management Division Senior Manager Signature : Date (dd/mm/aaaa): 2014/10/01</p>  
<p>Deklaraciju o zbrinjavanju proizvoda</p> <p>RoHS Direktiva 2011/65/EU WEEE Direktiva 2012/19/EC PPW Direktiva 94/62/EZ REACH Uredba (EZ) br. 1907/2006 EoP Direktiva 2009/125/EZ</p> <p>Ime/ naslov : Richard Hsu / Quality Management Division Senior Manager Podpis : Datum (dd/mm/yyyy): 01/10/2014</p>  	<p>Dichiarazione ambientale di prodotto</p> <p>RoHS Direttiva 2011/65/UE WEEE Direttiva 2012/19/UE PPW Direttiva 94/62/CE REACH REGOLAMENTO (CE) n. 1907/2006 EoP Direttiva 2009/125/CE</p> <p>Nome/ titolo : Richard Hsu / Quality Management Division Senior Manager Firma : Data (dd/mm/aaaa): 2014/10/01</p>  	<p>Produkta vides ietekmējuma deklarācija</p> <p>RoHS Direktīva 2011/65/ES WEEE Direktīva 2012/19/ES PPW Direktīva 94/62/EK REACH Regula (EK) Nr. 1907/2006 EoP Direktīva 2009/125/EK</p> <p>Nosaukums/ tituls : Richard Hsu / Quality Management Division Senior Manager Paraksts : Datums (dd/mm/yyyy): 01/10/2014</p>  	<p>Apinkosaušingų gaminių deklaraciją</p> <p>RoHS Direktyva 2011/65/ES WEEE Direktyva 2012/19/ES PPW Direktyva 94/62/EB REACH REGLAMENTAS (EB) Nr. 1907/2006 EoP Direktyva 2009/125/EB</p> <p>Vardas/ šiuo : Richard Hsu / Quality Management Division Senior Manager Parašas : Data (dd/mm/aaaa): 01/10/2014</p>  
<p>Környezetvédelmi terméknyilatkozatot</p> <p>RoHS 2011/65/EU irányelv WEEE 2012/19/EU irányelv PPW 94/62/EK irányelv REACH 1907/2006/EK rendelet EoP 2009/125/EK irányelv</p> <p>Név/ cím : Richard Hsu / Quality Management Division Senior Manager Aláírás : Dátum (dd/mm/yyyy): 2014/10/01</p>  	<p>Dikjarazzjoni Ambientali dwar il-Prodott</p> <p>RoHS Direttiva 2011/65/UE WEEE Direttiva 2012/19/UE PPW Direttiva 94/62/CE REACH REGOLAMENTO (CE) NRU 1907/2006 EoP Direttiva 2009/125/CE</p> <p>Isim/ titolu : Richard Hsu / Quality Management Division Senior Manager Firma : Data (dd/mm/aaaa): 2014/10/01</p>  	<p>Miljøproductverklaring</p> <p>RoHS Richtlin 2011/65/EU WEEE Richtlin 2012/19/EC PPW Richtlin 94/62/EG REACH Verordning (EG) nr. 1907/2006 EoP Richtlin 2009/125/EG</p> <p>Navn/ titel : Richard Hsu / Quality Management Division Senior Manager Handskrevet : Dato (dd/mm/år): 01/10/2014</p>  	<p>Deklaracja środowiskowa produktu</p> <p>RoHS Dyrektywa 2011/65/UE WEEE Dyrektywa 2012/19/UE PPW Dyrektywa 94/62/WE REACH Rozporządzenie (WE) nr. 1907/2006 EoP Dyrektywa 2009/125/WE</p> <p>Nazwisko/ tytuł : Richard Hsu / Quality Management Division Senior Manager Podpis : Data (dd/mm/aaaa): 2014/10/01</p>  
<p>Declaração ambiental do produto</p> <p>RoHS Diretiva 2011/65/UE WEEE Diretiva 2012/19/UE PPW Diretiva 94/62/CE REACH Regulamento (CE) n° 1907/2006 EoP Diretiva 2009/125/CE</p> <p>Nome/ título : Richard Hsu / Quality Management Division Senior Manager Assinatura : Data (dd/mm/aaaa): 01/10/2014</p>  	<p>Declarație de mediu privind produsele</p> <p>RoHS Directivă 2011/65/UE WEEE Directivă 2012/19/UE PPW Directivă 94/62/CE REACH REGULAMENTUL (CE) NR. 1907/2006 EoP Directivă 2009/125/CE</p> <p>Nume/ titlu : Richard Hsu / Quality Management Division Senior Manager Semnatura : Data (dd/mm/aaaa): 01/10/2014</p>  	<p>Vyhľadzenie o environmentálnom výrobu</p> <p>RoHS Smernica 2011/65/EU WEEE Smernica 2012/19/EC PPW Smernica 94/62/ES REACH Nařízení (ES) č. 1907/2006 EoP Smernica 2009/125/ES</p> <p>Menor/ titul : Richard Hsu / Quality Management Division Senior Manager Podpis : Datum (dd/mm/yyyy): 01/10/2014</p>  	<p>Okoljsko deklaracija izdelka</p> <p>RoHS Direktiva 2011/65/UE WEEE Direktiva 2012/19/UE PPW Direktiva 94/62/ES REACH Uredba (ES) br. 1907/2006 EoP Direktiva 2009/125/ES</p> <p>Ime/ nadz : Richard Hsu / Quality Management Division Senior Manager Podpis : Datum (dd/mm/yyyy): 01/10/2014</p>  
<p>Standardin perustava ympäristötuoteseloste</p> <p>RoHS Direktiiv 2011/65/EU WEEE Direktiiv 2012/19/EC PPW Direktiiv 94/62/EY REACH ASETUS (EY) N:o 1907/2006 EoP Direktiiv 2009/125/EY</p> <p>Nimi/ osasto : Richard Hsu / Quality Management Division Senior Manager Alaenkirja : Päivämäärä (pp/kk/vvvv): 01/10/2014</p>  	<p>Miljöproduktdeklaration</p> <p>RoHS Direktiv 2011/65/EU WEEE Direktiv 2012/19/EC PPW Direktiv 94/62/EY REACH Förordning (EG) nr 1907/2006 EoP Direktiv 2009/125/EG</p> <p>Navn/ titel : Richard Hsu / Quality Management Division Senior Manager Namnteckning : Datum (dd/mm/åååå): 01/10/2014</p>  	<p>Περιβαλλοντική δήλωση προϊόντος</p> <p>RoHS Οδηγία 2011/65/ΕΕ WEEE Οδηγία 2012/19/ΕΕ PPW Οδηγία 94/62/ΕΚ REACH Λειτουργία (ΕΚ) αριθ. 1907/2006 EoP Οδηγία 2009/125/ΕΚ</p> <p>Όνομα/ τίτλος : Richard Hsu / Quality Management Division Senior Manager Υπογραφή : Ημερομηνία (ηη/μμ/εεεε): 01/10/2014</p>  	<p>Miljødeklarasjon</p> <p>RoHS Direktiv 2011/65/UE WEEE Direktiv 2012/19/UE PPW Direktiv 94/62/EF REACH Forordning (EF) nr. 1907/2006 EoP Direktiv 2009/125/EF</p> <p>Navn/ titel : Richard Hsu / Quality Management Division Senior Manager Signatur : Dato (dd/mm/åååå): 01/10/2014</p>  

台灣



以下訊息僅適用於產品銷售至台灣地區

第十二條 經型式認證合格之低功率射頻電機，非經許可，公司、商號或使用者均不得擅自變更頻率、加大功率或變更原設計之特性及功能。

第十四條 低功率射頻電機之使用不得影響飛航安全及干擾合法通信；經發現有干擾現象時，應立即停用，並改善至無干擾時方得繼續使用。前項合法通信，指依電信法規定作業之無線電通信。低功率射頻電機須忍受合法通信或工業、科學及醫療用電波輻射性電機設備之干擾。

安全警告

為了您的安全，請先閱讀以下警告及指示：

- 請勿將此產品接近水、火焰或放置在高溫的環境。
- 避免設備接觸任何液體 - 切勿讓設備接觸水、雨水、高濕度、污水腐蝕性的液體或其他水份。
- 灰塵及污物 - 切勿接觸灰塵、污物、沙土、食物或其他不合適的材料。
- 雷雨天氣時，不要安裝，使用或維修此設備。有遭受電擊的風險。
- 切勿重摔或撞擊設備，並勿使用不正確的電源變壓器。
- 若接上不正確的電源變壓器會有爆炸的風險。
- 請勿隨意更換產品內的電池。
- 如果更換不正確之電池型式，會有爆炸的風險，請依製造商說明書處理使用過之電池。
- 請將廢電池丟棄在適當的電器或電子設備回收處。
- 請勿將設備解體。
- 請勿阻礙設備的散熱孔，空氣對流不足將會造成設備損害。
- 請插在正確的電壓供給插座（如：北美 / 台灣電壓 110V AC，歐洲是 230V AC）。
- 假若電源變壓器或電源變壓器的纜線損壞，請從插座拔除，若您還繼續插電使用，會有觸電死亡的風險。
- 請勿試圖修理電源變壓器或電源變壓器的纜線，若有毀損，請直接聯絡您購買的店家，購買一個新的電源變壓器。
- 請勿將此設備安裝於室外，此設備僅適合放置於室內。
- 請勿隨一般垃圾丟棄。
- 請參閱產品背貼上的設備額定功率。
- 請參考產品型錄或是彩盒上的作業溫度。
- 產品沒有斷電裝置或者採用電源線的插頭視為斷電裝置的一部分，以下警語將適用：
 - 對永久連接之設備，在設備外部須安裝可觸及之斷電裝置；
 - 對插接式之設備，插座必須接近安裝之地點而且是易於觸及的。

Viewing Certifications

Go to <http://www.zyxel.com> to view this product's documentation and certifications.

ZyXEL Limited Warranty

ZyXEL warrants to the original end user (purchaser) that this product is free from any defects in material or workmanship for a specific period (the Warranty Period) from the date of purchase. The Warranty Period varies by region. Check with your vendor and/or the authorized ZyXEL local distributor for details about the Warranty Period of this product. During the warranty period, and upon proof of purchase, should the product have indications of failure due to faulty workmanship and/or materials, ZyXEL will, at its discretion, repair or replace the defective products or components without charge for either parts or labor, and to whatever extent it shall deem necessary to restore the product or components to proper operating condition. Any replacement will consist of a new or re-manufactured functionally equivalent product of equal or higher value, and will be solely at the discretion of ZyXEL. This warranty shall not apply if the product has been modified, misused, tampered with, damaged by an act of God, or subjected to abnormal working conditions.

Note

Repair or replacement, as provided under this warranty, is the exclusive remedy of the purchaser. This warranty is in lieu of all other warranties, express or implied, including any implied warranty of merchantability or fitness for a particular use or purpose. ZyXEL shall in no event be held liable for indirect or consequential damages of any kind to the purchaser.

To obtain the services of this warranty, contact your vendor. You may also refer to the warranty policy for the region in which you bought the device at http://www.zyxel.com/web/support_warranty_info.php.

Registration

Register your product online to receive e-mail notices of firmware upgrades and information at www.zyxel.com for global products, or at www.us.zyxel.com for North American products.

Open Source Licenses

This product contains in part some free software distributed under GPL license terms and/or GPL like licenses. Open source licenses are provided with the firmware package. You can download the latest firmware at www.zyxel.com. To obtain the source code covered under those Licenses, please contact support@zyxel.com.tw to get it.

A

- ACL rule [212](#)
- ACS [255](#)
- activation
 - firewalls [208](#)
 - media server [201](#)
 - SIP ALG [175](#)
 - SSID [100](#)
- adding a printer example [55](#)
- Address Resolution Protocol [239](#)
- administrator password [23](#)
- antenna
 - directional [305](#)
 - gain [304](#)
 - omni-directional [305](#)
- AP (access point) [295](#)
- applications
 - Internet access [18](#)
 - media server [200](#)
 - activation [201](#)
 - iTunes server [200](#)
- applications, NAT [179](#)
- ARP Table [239](#), [241](#)
- authentication [113](#), [114](#)
 - RADIUS server [114](#)
- Authentication method
 - CHAP [74](#)
 - MSCHAP [74](#)
 - PAP [74](#)
- Auto Configuration Server, see ACS [255](#)

B

- backup
 - configuration [270](#)
- Basic Service Set, See BSS [293](#)
- Basic Service Set, see BSS
- blinking LEDs [20](#)

- Broadband [66](#)
- broadcast [92](#)
- BSS [116](#), [293](#)
 - example [116](#)

C

- CA [225](#), [299](#)
- Canonical Format Indicator See CFI
- CCMs [273](#)
- certificate
 - factory default [226](#)
- Certificate Authority
 - See CA.
- certificates [225](#)
 - authentication [225](#)
 - CA
 - creating [226](#)
 - public key [225](#)
 - replacing [226](#)
 - storage space [226](#)
- Certification Authority [225](#)
- Certification Authority. see CA
- certifications [320](#)
 - viewing [324](#)
- CFI [92](#)
- CFM [273](#)
 - CCMs [273](#)
 - link trace test [273](#)
 - loopback test [273](#)
 - MA [273](#)
 - MD [273](#)
 - MEP [273](#)
 - MIP [273](#)
- channel [295](#)
 - interference [295](#)
- channel, wireless LAN [112](#)
- CHAP [74](#)
- client list [131](#)
- compatibility, WDS [106](#)

configuration
 backup [270](#)
 firewalls [208](#)
 reset [271](#)
 restoring [271](#)
 static route [87](#), [142](#), [144](#), [183](#)

Connectivity Check Messages, see CCMs

contact information [287](#)

copyright [318](#)

CoS [161](#)

CoS technologies [149](#)

creating certificates [226](#)

CTS (Clear to Send) [296](#)

CTS threshold [109](#), [113](#)

customer support [287](#)

D

data fragment threshold [109](#), [113](#)

DDoS [208](#)

default server address [174](#)

Denials of Service, see DoS

DHCP [126](#), [138](#)

DHCP Option 43 [137](#)

DHCP option 43 [75](#), [136](#)

DHCP option 60 [75](#)

DHCP option 61
 DUID [75](#)
 IAD [75](#)

Differentiated Services, see DiffServ [161](#)

DiffServ [161](#)
 marking rule [161](#)

digital IDs [225](#)

disclaimer [318](#)

DLNA [200](#)

DMZ [173](#)

DNS [126](#), [138](#)

DNS server address assignment [92](#)

Domain Name [180](#)

Domain Name System, see DNS

Domain Name System. See DNS.

DoS [208](#)

DS field [161](#)

DS, dee differentiated services

DSCP [161](#)

dynamic DNS [182](#)
 wildcard [182](#)

Dynamic Host Configuration Protocol, see DHCP

dynamic WEP key exchange [300](#)

DYNDNS wildcard [182](#)

E

EAP Authentication [299](#)

ECHO [180](#)

e-mail
 log example [265](#)

Encapsulation [88](#)
 MER [89](#)
 PPP over Ethernet [89](#)

encapsulation
 RFC 1483 [89](#)

encryption [115](#), [301](#)

ESS [294](#)

Extended Service Set IDentification [96](#), [101](#)

Extended Service Set, See ESS [294](#)

F

Fast Leave [188](#)

FCC interference statement [320](#)

file sharing [19](#)

filters
 MAC address [102](#), [114](#)

Finger [180](#)

firewalls [207](#)
 add protocols [209](#)
 configuration [208](#)
 DDoS [208](#)
 DoS [208](#)
 LAND attack [208](#)
 Ping of Death [208](#)
 SYN attack [208](#)

firmware [267](#)
 version [63](#)

forwarding ports [166](#)

fragmentation threshold [109, 113, 296](#)

FTP [166, 180](#)

G

General wireless LAN screen [95](#)

H

hidden node [295](#)

HTTP [180](#)

I

IBSS [293](#)

ICMPv6 [186](#)

IEEE 802.11g [297](#)

IEEE 802.1Q [92](#)

IGA [178](#)

IGMP [92](#)

 multicast group list [186, 243](#)

 version [92](#)

IGMP Fast Leave [186](#)

IGMPv2 [186](#)

IGMPv3 [186](#)

ILA [178](#)

Independent Basic Service Set

 See IBSS [293](#)

initialization vector (IV) [301](#)

Inside Global Address, see IGA

Inside Local Address, see ILA

interface group [191](#)

Internet

 wizard setup [31](#)

Internet access [18](#)

 wizard setup [31](#)

Internet Protocol version 6 [68](#)

Internet Protocol version 6, see IPv6

Intra LAN Multicast [188](#)

IP address [126, 139](#)

 ping [274](#)

 private [139](#)

 WAN [67](#)

IP Address Assignment [91](#)

IP alias

 NAT applications [180](#)

IPv6 [68, 306](#)

 addressing [68, 93, 306](#)

 EUI-64 [308](#)

 global address [307](#)

 interface ID [308](#)

 link-local address [306](#)

 Neighbor Discovery Protocol [306](#)

 ping [306](#)

 prefix [68, 93, 306](#)

 prefix delegation [70](#)

 prefix length [68, 93, 306](#)

 unspecified address [307](#)

iTunes server [200](#)

L

LAN [125](#)

 and USB printer [201](#)

 client list [131](#)

 DHCP [126, 138](#)

 DNS [126, 138](#)

 IP address [126, 127, 139](#)

 MAC address [131](#)

 status [64](#)

 subnet mask [126, 127, 139](#)

LAN to LAN multicast [188](#)

LAND attack [208](#)

LAN-Side DSL CPE Configuration [257](#)

LBR [273](#)

limitations

 wireless LAN [115](#)

 WPS [123](#)

link trace [273](#)

Link Trace Message, see LTM

Link Trace Response, see LTR

login [23](#)

 passwords [23](#)

logs [232, 235, 243, 249, 264](#)

Loop Back Response, see LBR

loopback [273](#)

LTM [273](#)

LTR [273](#)

M

MA [273](#)

MAC address [103](#), [131](#)

filter [102](#), [114](#)

MAC authentication [102](#)

Mac filter [216](#)

Maintenance Association, see MA

Maintenance Domain, see MD

Maintenance End Point, see MEP

Management Information Base (MIB) [258](#)

managing the device

good habits [17](#)

Maximum Burst Size (MBS) [90](#)

MBSSID [116](#)

MD [273](#)

media server [200](#)

activation [201](#)

iTunes server [200](#)

MEP [273](#)

MLD [186](#)

MLDv1 [186](#)

MLDv2 [186](#)

MSCHAP [74](#)

MTU (Multi-Tenant Unit) [91](#)

multicast [92](#)

Multicast Listener Discovery, see MLD

Multiple BSS, see MBSSID

multiplexing [89](#)

LLC-based [90](#)

VC-based [89](#)

multiprotocol encapsulation [89](#)

N

NAT [165](#), [166](#), [167](#), [178](#)

applications [179](#)

IP alias [180](#)

example [179](#)

global [178](#)

IGA [178](#)

ILA [178](#)

inside [178](#)

local [178](#)

outside [178](#)

port forwarding [166](#)

port number [180](#)

services [180](#)

SIP ALG [174](#)

activation [175](#)

NAT example [181](#)

Network Address Translation, see NAT

Network Map [62](#)

network map [26](#)

NNTP [180](#)

P

Pairwise Master Key (PMK) [301](#), [303](#)

PAP [74](#)

passwords [23](#)

PBC [118](#)

Peak Cell Rate (PCR) [90](#)

Per-Hop Behavior, see PHB [161](#)

PHB [161](#)

PIN, WPS [118](#)

example [120](#)

Ping of Death [208](#)

Point-to-Point Tunneling Protocol, see PPTP

POP3 [180](#)

port forwarding [166](#)

ports [20](#)

Power Mgmt [203](#)

Power Mgmt Add [206](#)

PPPoE [89](#)

Benefits [89](#)

PPTP [180](#)

preamble [110](#), [113](#)

preamble mode [117](#)

prefix delegation [70](#)

Printer Server [201](#)

printer sharing [54](#)

and LAN [201](#)

- configuration [54](#)
- requirements [201](#)
- private IP address [139](#)
- PSK [301](#)
- push button [22](#)
- Push Button Configuration, see PBC
- push button, WPS [118](#)

Q

- QoS [148, 161](#)
 - marking [149](#)
 - setup [148](#)
 - tagging [149](#)
 - versus CoS [148](#)
- Quality of Service, see QoS

R

- RADIUS [298](#)
 - message types [298](#)
 - messages [298](#)
 - shared secret key [298](#)
- RADIUS server [114](#)
- remote management
 - TR-069 [255](#)
- Remote Procedure Calls, see RPCs [255](#)
- reset [21, 271](#)
- restart [272](#)
- restoring configuration [271](#)
- RFC 1058. See RIP.
- RFC 1389. See RIP.
- RFC 1483 [89](#)
- RFC 3164 [232](#)
- RIP [146](#)
- router features [18](#)
- Routing Information Protocol. See RIP
- RPPCs [255](#)
- RTS (Request To Send) [296](#)
 - threshold [295, 296](#)
- RTS threshold [109, 113](#)

S

- security
 - wireless LAN [113](#)
- Security Log [234](#)
- Security Parameter Index, see SPI
- service access control [253](#)
- Service Set [96, 101](#)
- Services [180](#)
- setup
 - firewalls [208](#)
 - static route [87, 142, 144, 183](#)
- Simple Network Management Protocol, see SNMP
- Single Rate Three Color Marker, see srTCM
- SIP ALG [174](#)
 - activation [175](#)
- SMTP [180](#)
- SNMP [180, 258, 259](#)
 - agents [258](#)
 - Get [259](#)
 - GetNext [259](#)
 - Manager [258](#)
 - managers [258](#)
 - MIB [258](#)
 - network components [258](#)
 - Set [259](#)
 - Trap [259](#)
 - versions [258](#)
- SNMP trap [180](#)
- SPI [208](#)
- srTCM [163](#)
- SSID [114](#)
 - activation [100](#)
 - MBSSID [116](#)
- static route [141, 146, 262](#)
 - configuration [87, 142, 144, 183](#)
 - example [141](#)
- static VLAN
- status [62](#)
 - firmware version [63](#)
 - LAN [64](#)
 - WAN [64](#)
- status indicators [20](#)
- subnet mask [126, 139](#)
- Sustained Cell Rate (SCR) [90](#)
- SYN attack [208](#)

syslog
 protocol [232](#)
 severity levels [232](#)

system
 firmware [267](#)
 version [63](#)
 passwords [23](#)
 reset [21](#)
 status [62](#)
 LAN [64](#)
 WAN [64](#)
 time [260](#)

T

Tag Control Information See TCI
 Tag Protocol Identifier See TPID
 TCI
 The [67](#)
 thresholds
 data fragment [109, 113](#)
 RTS/CTS [109, 113](#)
 time [260](#)
 TPID [92](#)
 TR-064 [257](#)
 TR-069 [255](#)
 ACS setup [255](#)
 authentication [256](#)
 traffic shaping [90](#)
 trTCM [163](#)
 Two Rate Three Color Marker, see trTCM

U

unicast [92](#)
 Universal Plug and Play, see UPnP
 upgrading firmware [267](#)
 UPnP [132](#)
 cautions [127](#)
 NAT traversal [126](#)
 USB features [19](#)

V

Vendor ID [136, 137](#)
 VID
 Virtual Circuit (VC) [89](#)
 Virtual Local Area Network See VLAN
 VLAN [91](#)
 Introduction [91](#)
 number of possible VIDs
 priority frame
 static
 VLAN ID [92](#)
 VLAN Identifier See VID
 VLAN tag [92](#)

W

WAN
 status [64](#)
 Wide Area Network, see WAN [66](#)
 warranty [324](#)
 note [324](#)
 WDS [106, 117](#)
 compatibility [106](#)
 example [117](#)
 web configurator [23](#)
 login [23](#)
 passwords [23](#)
 WEP [115](#)
 WEP Encryption [98, 99](#)
 WEP encryption [97](#)
 WEP key [97](#)
 Wi-Fi Protected Access [300](#)
 wireless client WPA supplicants [302](#)
 Wireless Distribution System, see WDS
 wireless LAN [94, 111](#)
 authentication [113, 114](#)
 BSS [116](#)
 example [116](#)
 channel [112](#)
 encryption [115](#)
 example [112](#)
 fragmentation threshold [109, 113](#)
 limitations [115](#)
 MAC address filter [102, 114](#)

- MBSSID [116](#)
- preamble [110](#), [113](#)
- RADIUS server [114](#)
- RTS/CTS threshold [109](#), [113](#)
- security [113](#)
- SSID [114](#)
 - activation [100](#)
- WDS [106](#), [117](#)
 - compatibility [106](#)
 - example [117](#)
- WEP [115](#)
- WPA [115](#)
- WPA-PSK [115](#)
- WPS [117](#), [120](#)
 - example [121](#)
 - limitations [123](#)
 - PIN [118](#)
 - push button [22](#), [118](#)
- wireless security [297](#)
- Wireless tutorial [37](#)
- wizard setup
 - Internet [31](#)
- WLAN
 - interference [295](#)
 - security parameters [304](#)
- WPA [115](#), [300](#)
 - key caching [302](#)
 - pre-authentication [302](#)
 - user authentication [301](#)
 - vs WPA-PSK [301](#)
 - wireless client supplicant [302](#)
 - with RADIUS application example [302](#)
- WPA2 [300](#)
 - user authentication [301](#)
 - vs WPA2-PSK [301](#)
 - wireless client supplicant [302](#)
 - with RADIUS application example [302](#)
- WPA2-Pre-Shared Key [301](#)
- WPA2-PSK [301](#)
 - application example [303](#)
- WPA-PSK [115](#), [301](#)
 - application example [303](#)
- WPS [117](#), [120](#)
 - example [121](#)
 - limitations [123](#)
 - PIN [118](#)
 - example [120](#)
 - push button [22](#), [118](#)